

Charging stand for single pipette

AX-ST-CH-A1

Instruction Manual

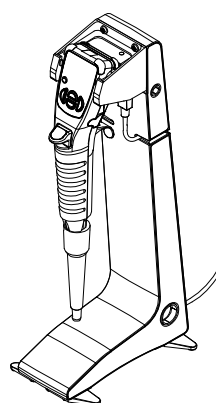

© 2015 A&D Company Ltd. All rights reserved.
No part of this publication may be reproduced, transmitted, transcribed, or translated into any language in any form by any means without the written permission of A&D Company Ltd.

The contents of this manual and the specifications of the instrument covered by this manual are subject to change for improvement without notice.



1WMPD4003080B

Safety Use

Please note the following items when the device is used.

CAUTION

- Do not disassemble the device. Any damage or loss of functions caused by disassembly is not covered by warranty.
- Do not link more than the maximum of three charging stands. Linking four units or more may cause fire or damage the units or the PA/PB series of electronic pipettes (hereinafter called PA/PB).
- Use the AC adapter provided for the PA/PB main unit, as otherwise the charging stand, the PA/PB, or the power supply devices may be damaged.

1. Introduction

This pipette describes how the AX-ST-CH-A1 charging stand for single PA/PB works. To fully understand and make use of the product, please read this manual carefully before use. Also, please read the instruction manual for the PA/PB.

2. Package Contents and Each Part Name

- Package contents
 - Charging stand for single pipette
 - Linking cable (AX-KO4730-10)
 - Instruction manual (This document)

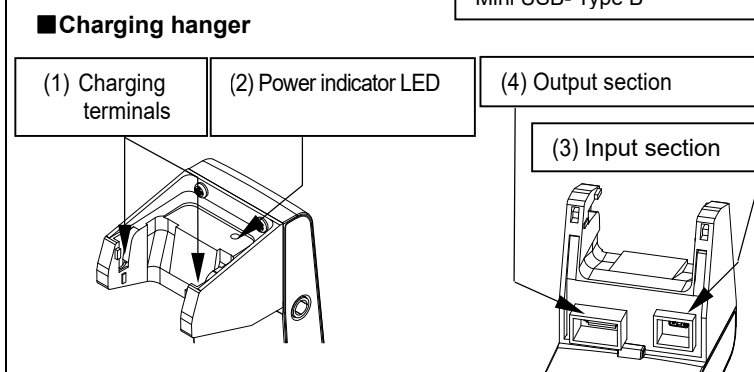
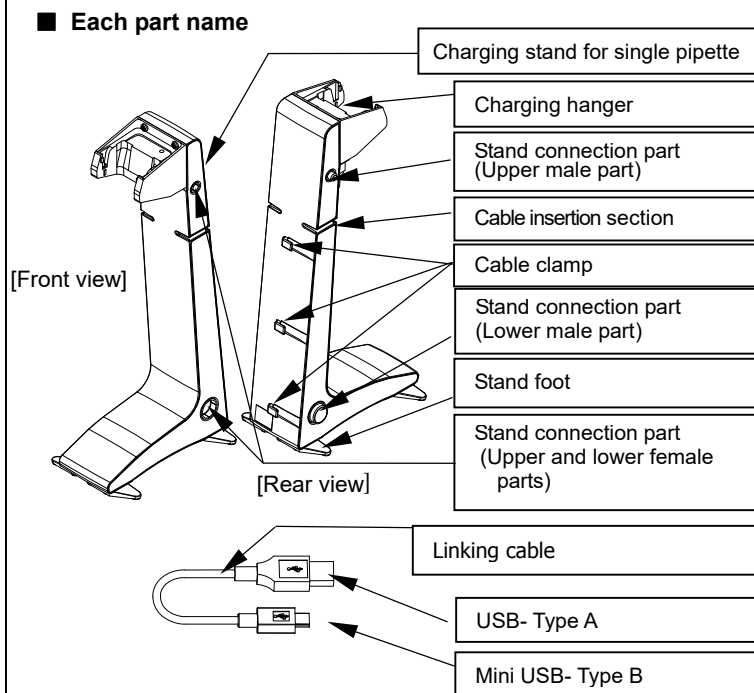

- (1) Charging terminals: Receive an PA/PB for charging.
- (2) Power indicator LED: Lights up in green when power is supplied to the charging stand.
- (3) Input section: Connects with the cable from the AC adapter provided for the PA/PB main unit. To link another stand, connect the output section (4) with the input section (3) of the stand to be added using the linking cable. (Connects with Mini USB- Type B).
- (4) Output section: Used for linking multiple charging stands. (Connects with USB- Type A)

3. Features

- Charging starts automatically when an PA/PB is hooked onto the charging stand.
- Power supply stops automatically when charging is complete.
- Space saving installation (60 mm (excluding the stand feet) × 154 mm)
- By linking up to three charging stands, it is possible to charge three pipettes at the same time.

4. How to Use

Prepare the power cable and AC adapter (AX-TB283) that are provided with PA/PB and connect them to this device.

- Connect the power cable to the input section (3) so that the USB mark on the USB- Type B of the power cable faces the device.
- Run the power cable to the back side of the charging stand through the cable insertion section, and then push it into the three cable clamps.
- Connect the USB- Type A to the AC adapter.

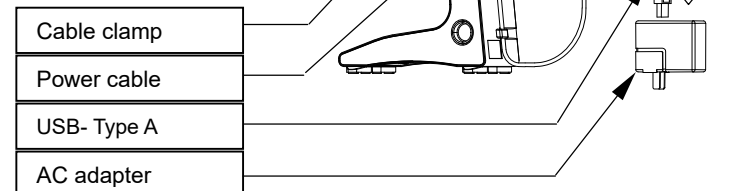

Charging the PA/PB

- Insert the AC adapter into an outlet. The power indicator LED (Green) (2) will light up.
- Hook an PA/PB onto the charging section to begin charging. While charging, the battery indicator on the PA/PB display blinks as shown in the following figure to indicate that the device is being charged.

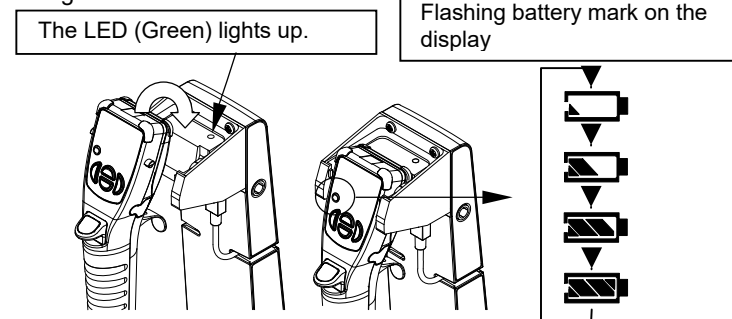

- Charging is complete when the battery indicator is fully lit.
- The PA/PB can continue to be hooked to the charging stand after it is fully charged. (It will not be overcharged.)

5. Linking Charging Stands

Up to three charging stands can be used in conjunction to charge multiple PA/PB simultaneously. (The following figure shows the example of two units.)

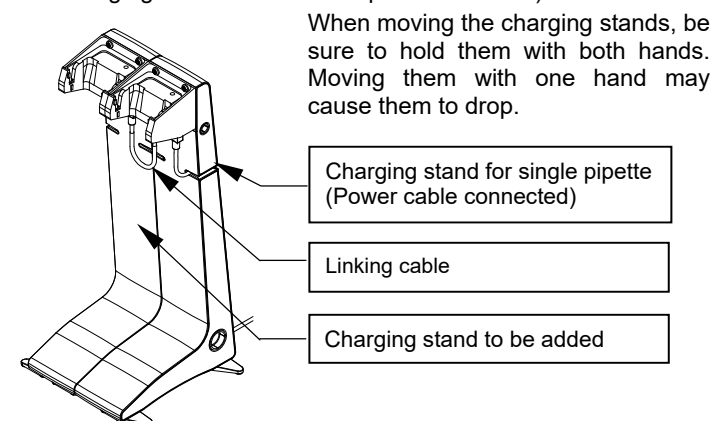

Linking charging stands

- Remove the four stand feet located on the sides of the stands to be attached.
- Join the upper and lower male parts on one stand to the upper and lower female parts on the other, and then push them in.
- Attach two stand feet as shown in the following figure. The stand feet also link the charging stands.
* Only two stand feet are used.

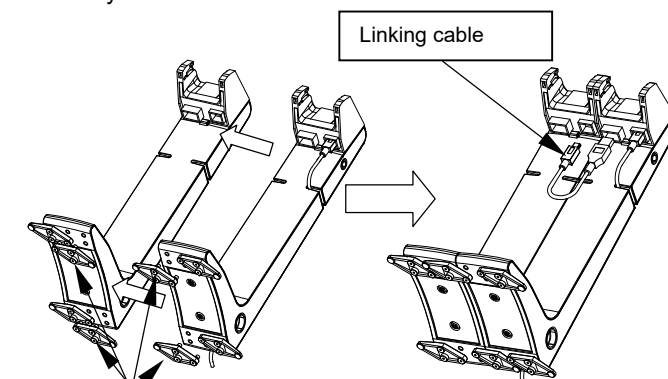

Remove the stand feet. Align the connection parts to combine the two charging stands.

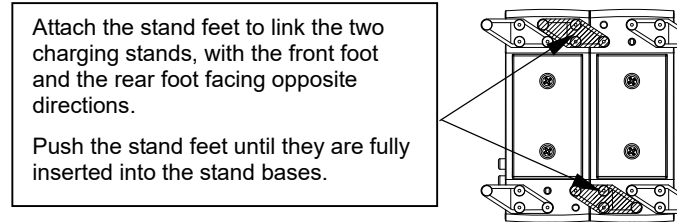

- Connect the output section (4) of the charging hanger with the input section (3) of the stand to be added using the linking cable.

- Insert the AC adapter connected with the power cable into an outlet. The power indicator LEDs (Green) (2) of each of the two charging hangers will light up, and two pipettes can be charged simultaneously.

6. Specifications

Input (Specified adapter)	AC 100 V / 0.3A (50 / 60 Hz)
Input section / output section	DC 5V
Connectable devices	Electronic pipette PA/PB series
Dimensions	95(W) × 335(H) × 154(D)mm
Net weight	Approx. 500g (Excluding the AC adapter)

7. Accessories

- Linking cable AX-KO4730-10
- AC adapter for the PA/PB AX-TB283
(The AX-TB283 is the standard accessory for the electronic pipette PA/PB series.)