

**TM-2655**

**TM-2655P**

---

# INSTRUCTION MANUAL

---

Automatic Blood Pressure Monitor

**AND**

A&D Company, Limited

**© 2013 A&D Company, Limited All rights reserved.**

No part of this publication may be reproduced, transmitted, transcribed, or translated into any language in any form by any means without the written permission of A&D Company, Limited.

The contents of this manual and the specifications of the instrument covered by this manual are subject to change for improvement without notice.

# WARNING DEFINITIONS

The warnings described in this manual have the following meanings:



## WARNING

*Important information to alert you to a situation that might cause injury and/or damage to your property if instructions are not followed.*



## CAUTION

*Important information to alert you to a situation that might cause minor injury and/or damage to your property if instructions are not followed.*

## Note

*Important information that helps users operate the device.*

# COMPLIANCE

## **Compliance with the European Directive 93/42/EEC for Medical Products**

This device conforms to the following requirements: European Directive 93/42/EEC for Medical Products act; Medical Products Act; European Standards for Electrical Equipment EN 60601-1 (General Safety Provisions), EN 60601-1-2 and EN 55011 (Electromagnetic Compatibility); European Standards pertaining to Non Invasive Blood Pressure Instruments EN 1060-1(General Requirements), EN 1060-3 (Supplementary Requirements for Electromechanical Blood Pressure Measuring Systems).

This is evidenced by the  mark of conformity accompanied by the reference number of a designated authority.

This device was designed for use by adults only.

## **Compliance with the Australian EMC Frame Work**

This device conforms to the following requirements: EMC Emission Standard for Industrial, Scientific and Medical Equipment AS/NZS 2064-1997, EMC Generic Immunity standard AS/NZS 4252.1-1994. This is evidenced by the C-Tick label.

## **Environment for use**

The device is for use in offices, sports facilities, and hospitals (waiting rooms), etc.

### **NOTE**

*This device does not have the function of automatic cycling measurement.  
Therefore, a part of this device does not conform to IEC60601-2-30.*

# SAFETY PRECAUTIONS



## WARNING

### Grounding

To avoid electrical shock, connect the power cable to an electrical outlet having a ground terminal for grounding the device.

### Fuse

To avoid a fire hazard, use only a fuse of the proper type, voltage and current rating as specified on the rear panel. Never bypass a fuse by shorting across the fuse holder and connectors.

### Service

Internal service or adjustment to this device should be performed by a qualified person only. Do not disassemble or modify the device.

### Device failure

If a device failure occurs, promptly stop using it. Have the patient remove their arm from the device and secure the patient's safety. Turn the power off and disconnect the power cable from the electrical outlet. Affix a notice such as "Out of Order" and "Do Not Use" on the device. Ask the nearest dealer for services.

### To interpret blood pressure measurements

Only a trained medical professional is qualified to interpret the blood pressure measurements. No device can replace regular medical checkups by a doctor. A doctor should verify the blood pressure measurements before making adjustments to medication.

### If the device gets wet because of a liquid spill

If the device gets wet, promptly stop using it. Have the patient remove their arm from the device and secure the patient's safety. Turn the power off and disconnect the power cable from the electrical outlet. Affix a notice such as "Out of Order" and "Do Not Use" on the device. Ask the nearest dealer for service.



## CAUTION

### In case of emergency

Press the EMERGENCY STOP switch located on the front of the device. This will release the air in the arm cuff so that the arm can be removed easily. It also operates if there is a power failure.

### To stop the operation at any time

Press the START/STOP switch located on the display panel. The quick exhaust will release the air in the arm cuff and the arm cuff will become loose.

### Maintenance/Inspection

Check all functions periodically. Ask the nearest dealer for this inspection.

Do not disassemble or modify the device.

If using the device for the first time after an extended period of storage, check the device for proper operation.

# GENERAL PRECAUTIONS

Obey the following precautions for safe and correct usage.

Precautions unique to the TM-2655/TM-2655P appear on the relevant pages in this manual. Read the manual thoroughly before use.

## When installing and storing the device

- Install or store the device away from moisture.
- Do not install or store the device where the device may be badly affected by extreme temperature, humidity, direct sunlight, draft, dust, salinity or sulfur content in the air.
- Do not install or store the device where chemicals, and corrosive or explosive gases are stored or present.
- Install or store the device in a secure, level and stable location.
- Install or store the device where adequate power is provided. (Where a medical 3P electrical outlet is provided.)

## Before use

- Check to make sure the device operates safely and accurately.
- Check all cables for proper connection.
- When other electrical equipment is used nearby, at the same time, a diagnostic error or dangerous situation may occur. Check all connections to make sure they do not interfere with each other.
- When telemeters are used, check that mutual interference will not cause a problem.

## During use

- Check the patient and the device during use.
- If medical or operational problems are found in the device or the patient, stop using the device immediately, check the status of the patient and take proper action.
- Do not use the device during MRI scanning.
- Do not use the device on a patient using a heart-lung machine.
- High frequency interference by electrosurgery or energy discharged by a defibrillator may damage the device. Follow the precautions described in the manual for each device.
- Do not use a cellular telephone near the device. It could affect the device's operation.
- The personal computer and medical equipment connected to the device are not allowed to be in the patient area.
- The personal computer used must conform to IEC60950

## After use

- Follow the predetermined procedure to return the operation switches to their original positions, and then turn off the power.
- Do not forcibly pull out the cables. Hold the connector with your hand when disconnecting the cable.
- Keep the device clean and in proper operating condition so that it can be used without problem during the next operation.
- Clean the accessories and arrange them before storage.

## Environmental protection

- Remove the built-in lithium battery from the device when the device is to be disposed of.
- This device, any part of, and the built-in lithium battery are not treated as ordinary household waste, and must be disposed of according to the applicable regulations.

# CONTENTS

<b>WARNING DEFINITIONS</b> .....	<b>I</b>
<b>COMPLIANCE</b> .....	<b>II</b>
<b>SAFETY PRECAUTIONS</b> .....	<b>III</b>
<b>GENERAL PRECAUTIONS</b> .....	<b>IV</b>
<b>CONTENTS</b> .....	<b>1</b>
<b>1. INTRODUCTION</b> .....	<b>3</b>
1-1 Features.....	3
1-2 Unpacking and Inspection .....	4
1-3 Specifications.....	5
<b>2. PART NAMES</b> .....	<b>6</b>
2-1 Main Unit.....	6
2-2 Rear Panel .....	7
2-3 Symbols .....	7
<b>3. INSTALLATION</b> .....	<b>9</b>
<b>4. OPERATION</b> .....	<b>10</b>
<b>5. SETTING THE CLOCK</b> .....	<b>12</b>
5-1 Clock Adjustment Mode.....	12
5-2 A Setting Example.....	12
<b>6. INSTALLING THE PRINTER PAPER</b> .....	<b>14</b>
<b>7. SETTING THE FUNCTIONS</b> .....	<b>16</b>
7-1 Function Setting Mode.....	16
7-2 Description of the Functions .....	17
7-3 Printing Samples.....	18
<b>8. COMMUNICATION SPECIFICATIONS</b> .....	<b>19</b>
8-1 Channel 1 : Miniature 8-pin DIN .....	19
8-2 Channel 2: D-sub 9-pin.....	20

## **9. MAINTENANCE**

9-1 Replacing the Arm Cuff Cover .....	21
9-2 Replacing the Fuses .....	22
9-3 Checking the Counter .....	22
<i>Displaying the counter</i> .....	22
<i>Resetting the counter</i> .....	23
<i>Printing the counter graph</i> .....	23
9-4 Error Codes .....	23
9-5 Maintenance .....	23
9-6 Cleaning.....	23
9-7 Options and Consumables .....	24
<b>10. TROUBLESHOOTING .....</b>	<b>25</b>
<b>11. EXTERNAL DIMENSIONS.....</b>	<b>26</b>
<b>APPENDIX: EMC INFORMATION .....</b>	<b>27</b>



# 1.INTRODUCTION

## 1-1 Features

---

The TM-2655/TM-2655P is a blood pressure monitor that measures systolic and diastolic blood pressure and pulse. The TM-2655 is a standard model; the TM-2655P is equipped with a printer unit. The features of the devices are as follows:

### **COMPACT DESIGN**

Due to its compactness, the TM-2655/TM-2655P can be installed in an area where space is limited. You can measure your blood pressure on either arm.

### **AUTOMATIC-CUFF SYSTEM / AUTOMATIC-EXHAUST-ADJUSTMENT SYSTEM**

The arm cuff is wrapped around the arm by pressing the START/STOP switch and deflation speed is automatically controlled. No special adjustment is required. All you have to do is insert your arm into the arm insertion section to the shoulder and press the START/STOP switch. The rest is done automatically. You can easily and quickly measure your blood pressure. The TM-2655/TM-2655P is suitable for mass medical check-ups at firms and sports facilities and in hospital waiting rooms when used for a pre-check of the patient's health status.

### **BUILT-IN PRINTER (TM-2655P only)**

The TM-2655P is equipped with a printer unit, which allows measurement results to be printed out for record keeping. The print format can be selected from results only, results with pulse pressure graph or a list of the results.

### **BUILT-IN CLOCK**

The date and time of measurement can be printed along with the measurement results.

### **COUNTER (UP TO 999999 COUNTS)**

The counter indicates how often the device is used. It can be a helpful guideline for maintaining the device.

### **SAFETY SYSTEM**

The TM-2655/TM-2655P adopts an emergency stop system. In case of emergency, pressing the EMERGENCY STOP switch will release the air in the arm cuff so that the arm can be removed easily. This system also functions if there is a power failure.

### **REPLACEABLE ARM CUFF COVER**

The arm cuff cover can be easily replaced.

## 1-2 Unpacking and Inspection



**CAUTION**

Handle this device carefully at all times. Strong shock to the device may cause trouble during operation.

### Note

*Save the packing material for later use.*

Unpack the TM-2655/TM-2655P carefully and verify that the following items are contained.

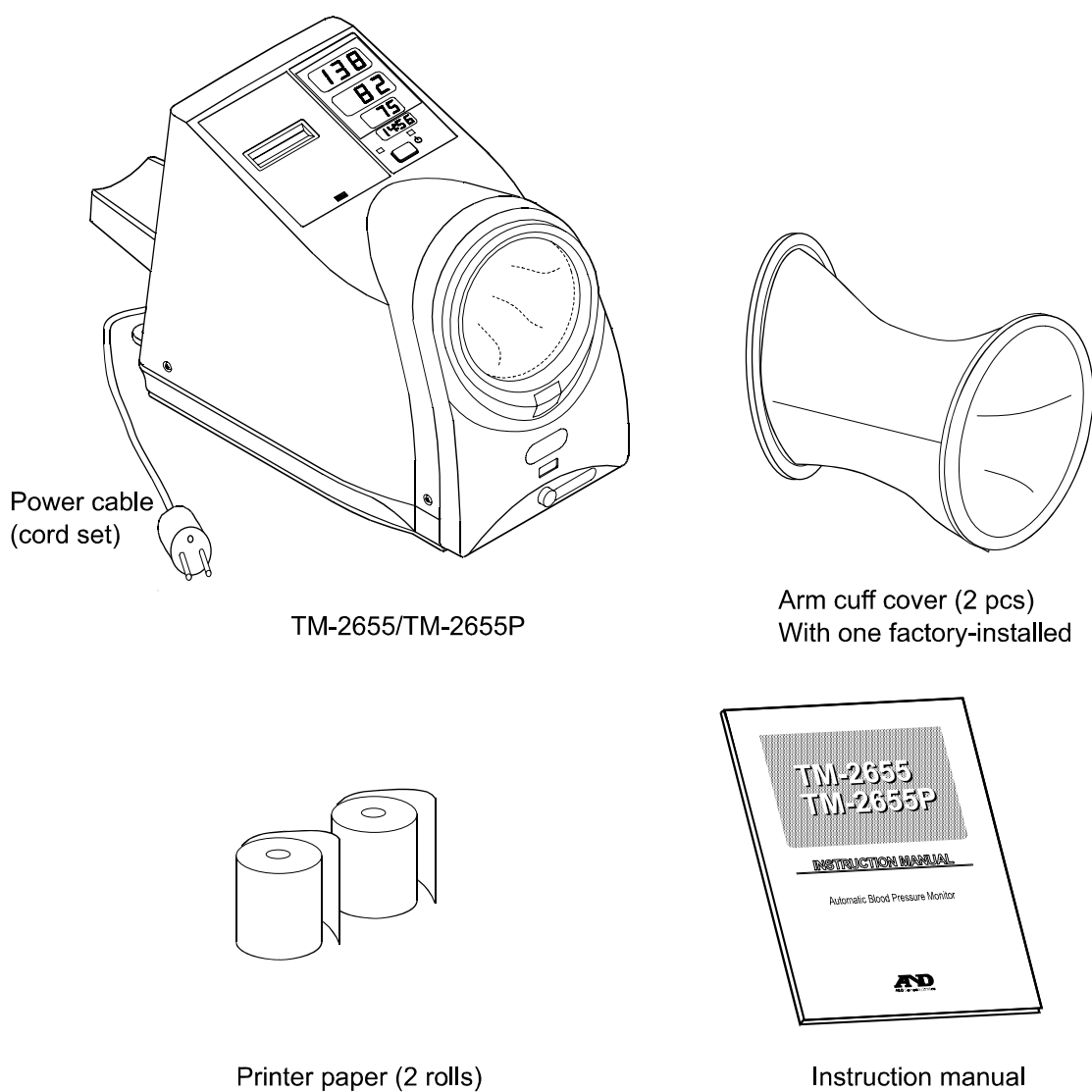

*Fig.1 Items contained*

## 1-3 Specifications

Table 1 Specifications

### Performance specifications

<b>General</b>	
Power supply	120VAC 60 Hz (For USA area) 230VAC 50 Hz (For Europe area) (factory-preset)
Power consumption	Approx. 40VA
Protection against electrical shock	Class I , Type B 
Display	LED
EMC	EN 60601-1-2
<b>Blood pressure measurement</b>	
Blood pressure measuring method	Oscillometric method
Pressure detection method	Capacitance type pressure transducer
Pressure range	0 – 300 mmHg
Accuracy	Pressure: $\pm 3$ mmHg Pulse rate: $\pm 5\%$
Measurement range	Blood pressure: 10 – 280 mmHg Pulse rate: 30 – 200 bpm
Pressurizing method	Micro pump
Air pressure control method	Rubber valve, ceramic valve
Rapid air exhaust system	Electromagnetic valve
Safety mechanism	The electromagnetic valve is released when approx. 320 mmHg or greater is detected.
Communications functions	Serial output: RS232C level

### Environment specifications

Operating temperature and humidity	10 to 40°C, 85%RH or less, non condensing
Storage/transporting temperature and humidity	-20 to 60°C, 95%RH or less, non condensing

### Physical specifications

Overall dimensions	245(W) X 322(H) X 390(D) mm
Weight	Approx. 9 kg

## 2. PART NAMES

### 2-1 Main Unit

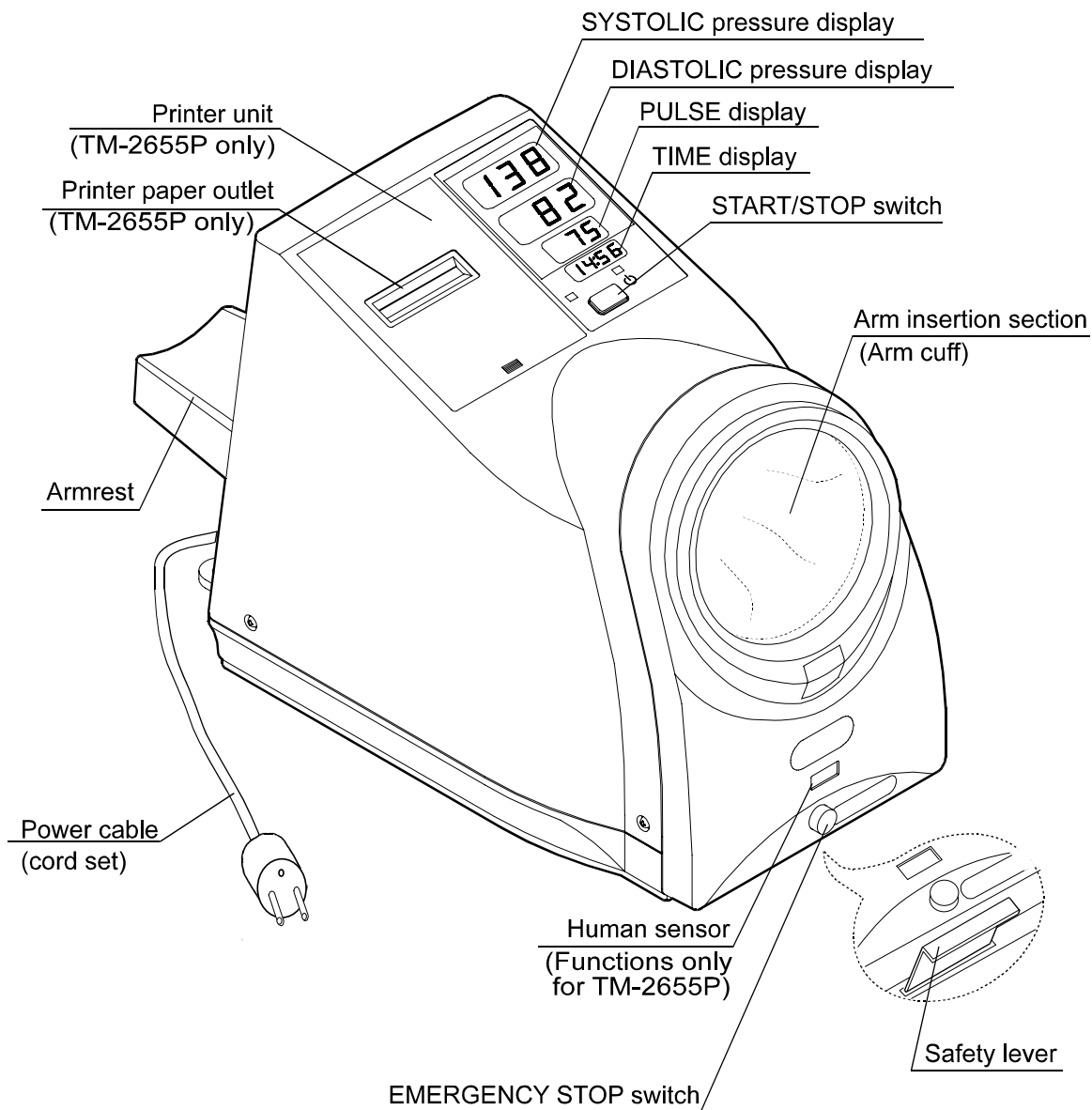
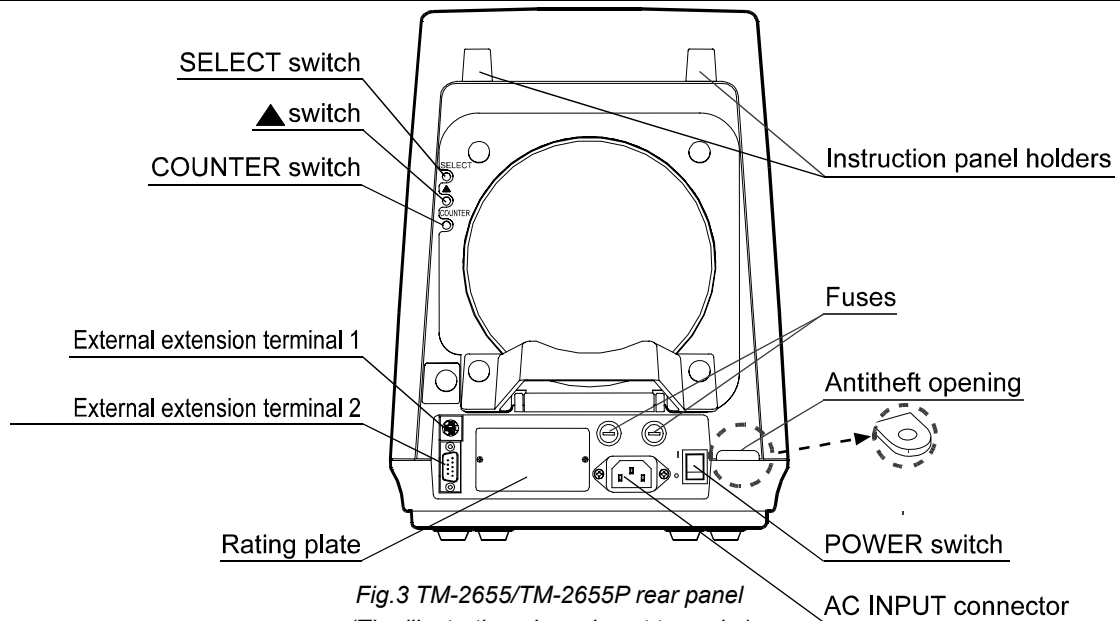

Fig.2 TM-2655/TM-2655P whole view

#### Note

- The printer unit is available only for the TM-2655P.
- The human sensor area appears the same for both models, but it functions only for the TM-2655P.
- The illustration above is not to scale.

## 2-2 Rear Panel



## 2-3 Symbols

The symbols used with the TM-2655/TM-2655P have the following functions or meanings.

Table 2 Symbol descriptions

Symbols	Function/Meaning
	Starts and stops a measurement.
	Turns the device on.
	Turns the device off.
	Alternating current
<b>SN</b>	Serial number
	Fuse
	RS-232C serial interface
2000	Date of manufacture
	Type B: Device, cuff and tubing are designed to provide special protection against electrical shocks.
	The medical device label by the EC directive
	The certification trade mark registered to the Australian Communications Authority by the Trademarks office.
<b>SYSTOLIC</b> <b>SYS</b>	Systolic blood pressure in mmHg
<b>DIASTOLIC</b> <b>DIA</b>	
<b>PULSE</b> <b>PUL</b>	Pulse beats per minute
	See the instruction manual.
	WEEE label
	Irregular Heartbeat indicator. (I.H.B.)The indicator that prints out when an irregular heartbeat or any excessive body movement is detected during the measurement.
<b>MAP</b>	Means arterial pressure in mmHg
<b>Exx</b>	Error code ( xx = 00 - 99 )

### **What is An Irregular Heartbeat?**

The TM-2655P provides a blood pressure and pulse rate measurement even when an irregular heartbeat occurs. An irregular heartbeat is defined as a heartbeat that varies by 25% from the average of all heartbeats during the blood pressure measurement. It is important that you are relaxed, remain still and do not talk during measurements.

#### **Note**

*We recommend that a physician should examine the patient if the “” logo appears on the printout or request a second reading.*

*It is possible for an Irregular Heartbeat (“”) to occur if a patient moves position or engages in conversation during a reading so care should be taken to eliminate the possibility of these events recurring.*

# 3.INSTALLATION

Follow the procedure below to install the TM-2655/TM-2655P.

1. To ensure that the TM-2655/TM-2655P works properly, install the device in an environment where:
  - The temperature range is from 10°C to 40°C (50°F to 104°F).
  - The humidity is less than 85% (non condensing).
  - It is away from water, dust, chemicals, and corrosive or explosive gases.
  - It is not exposed to direct sunlight.
2. Place the TM-2655/TM-2655P on a table solid enough to support its weight.
3. Adjust the height of the chair and table so that the arm insertion section is at the user's heart level.

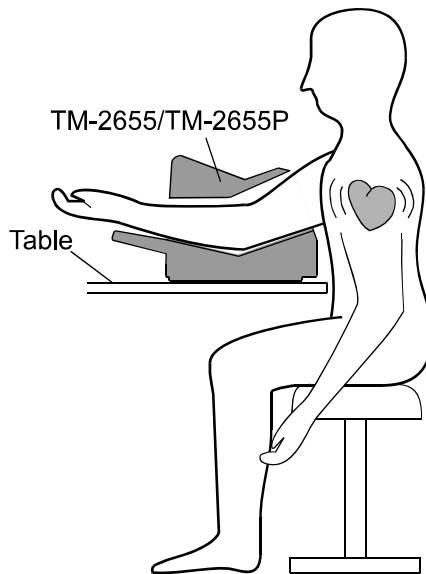

Fig.4 Proper installation

4. Use the power cable provided with the device to connect between the AC INPUT connector and an electrical outlet.

Using the anti-theft opening, secure the device to the table with a solid chain.

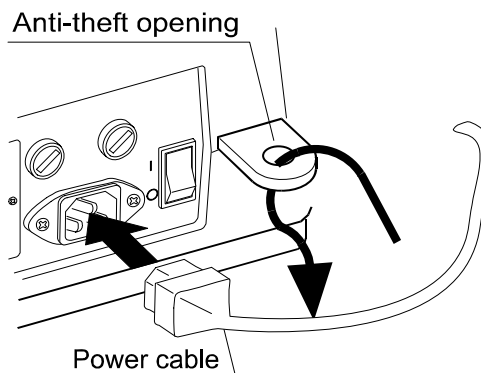

Fig.5 Power cable connection

## Note

Be sure to use the correct voltage for the power source.

## 4. OPERATION

1. Turn on the POWER switch located on the rear panel.

When the POWER switch is turned on, all of the display symbols will appear for several seconds. Then;

- (TM-2655) “0” (zero) appears in the SYSTOLIC pressure display, indicating that the device is ready for measurement.
- (TM-2655P) The human sensor functions for three minutes. When it does not detect a person, “. ” (dot) appears in the SYSTOLIC pressure display, indicating that the device is ready for measurement.

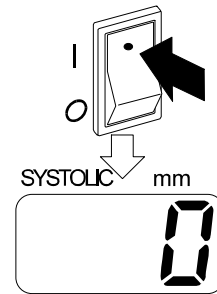

Fig.6 POWER switch and SYSTOLIC display (TM-2566)

### Note

*Please do not press the START/STOP switch when you turn on the power switch. Pressing and holding the START/STOP switch while all of the LED indicators are illuminated, will cause the device to enter the internal inspection mode.*

2. Take off your jacket.

If you wear a thick jacket, take it off for a better measurement.

### Note

*Wearing a thick jacket may cause a faint pulse, and result in a measurement error.*

3. Adjust the height of the chair and table.

Adjust the height of the chair and table so that the arm insertion section is at your heart level.

4. Insert your arm into the arm insertion section.

### Note

*Be sure to insert your arm to the shoulder.*

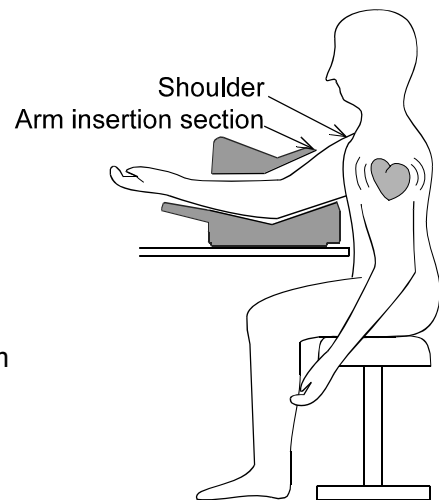

Fig.7 Proper posture

5. Press the START/STOP switch to start measurement.

6. The cuff will be pressurized automatically up to the predetermined pressure. Refer to “7-2 Description of the Functions” for details.

7. When pressurization is complete, the automatic exhaust mechanism will gradually reduce the pressure in the cuff. Just relax and remain still.

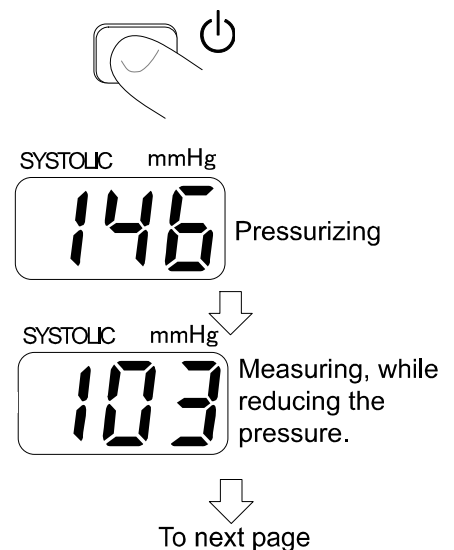

Fig.8 Measuring procedure



8. When the measurement is complete, the air is automatically released from the cuff and the cuff will become loose.

9. The measurement results appear in the display.

10. (TM-2655P) The measurement results are output to the printer.

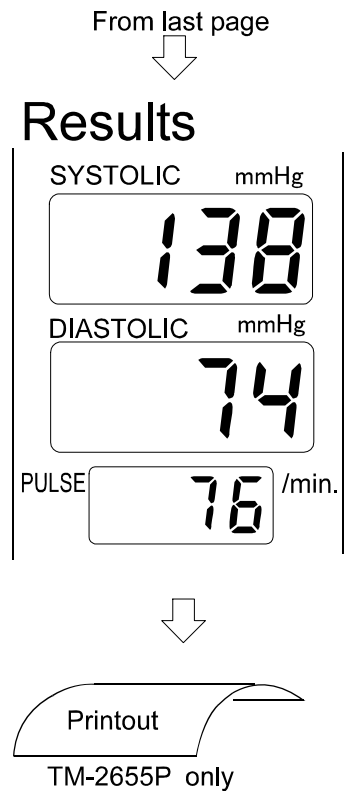

Fig.9 Measurement results

#### Note

- To stop the measurement at any time, press the START/STOP switch. The quick exhaust will reduce the pressure in the cuff and the cuff will become loose.
- If the air is not exhausted even when the START/STOP switch is pressed, press the EMERGENCY STOP switch.
- If your arm can not be removed from the cuff due to the power failure, press the safety lever located on the front lower part of the device. It disconnects the clutch to loosen the cuff.
- Please wait for about 10 minutes before repeating the measurement.

# 5.SETTING THE CLOCK

## 5-1 Clock Adjustment Mode

The clock is set in the clock adjustment mode. The clock adjustment mode display and switches used are as shown below:

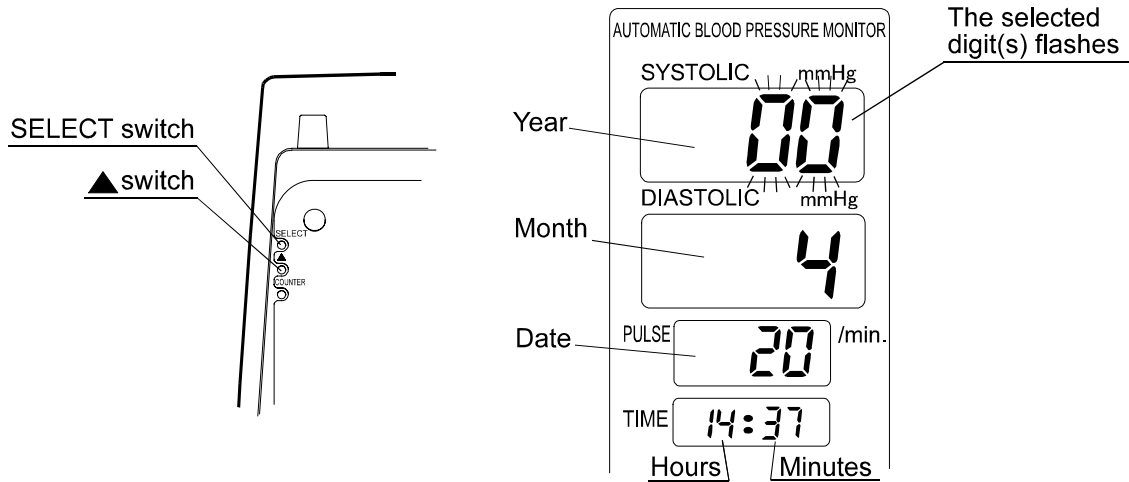

Fig.10 Switches for setting the clock and the clock adjustment mode display

Table 3 Switches for setting the clock

SELECT switch	<p>(1) Press to enter the clock adjustment mode.</p> <p>(2) (In the clock adjustment mode) Press to select the unit to be adjusted. The selected unit flashes. Each time the switch is pressed, the flashing unit changes: from “Year” to “Month”, “Date”, “Hours”, and “Minutes”.</p> <p>(3) Press to quit the clock adjustment mode.</p>
▲switch	Press to change the flashing digit(s).

## 5-2 A Setting Example

The following is the procedure to adjust the clock to 14:07, April 20, 2001.

1. Press the SELECT switch to make the SYSTOLIC display flash.
2. Press the ▲ switch to display “01” for 2001.
3. Press the SELECT switch to make the DIASTOLIC display flash.
4. Press the ▲ switch to display “4” for April.
5. Press the SELECT switch to make the PULSE display flash.
6. Press the ▲ switch to display “20”.
7. Press the SELECT switch to make the hours section of the TIME display flash.

8. Press the ▲ switch to display “14”.
9. Press the SELECT switch to make the minutes section of the TIME display flash.
10. Press the ▲ switch to display “07”.
11. Press the SELECT switch to return to the measurement mode.

**Note**

- *If no operation is performed for one minute, while setting the minutes section and for five seconds while setting the others, the settings performed so far will be confirmed and the device will return to the measurement mode.*
- *The clock can be set up to December 31, 2091.*

## 6. INSTALLING THE PRINTER PAPER

(This chapter is applicable only to the TM-2655P.)

With the power turned on, install the printer paper as follows:

1. Cut the top end of the printer paper with scissors. If the end is not smooth, it may cause a paper jam or damage the printer head.

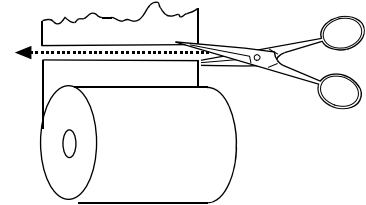

2. Press lightly on the center of the printer cover to open the cover.

Printer cover

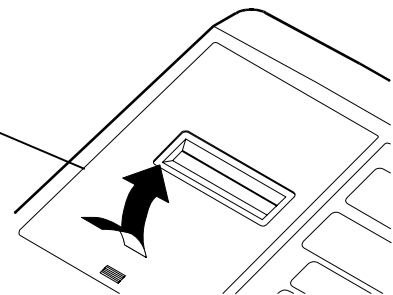

3. Raise the lever located on the right side of the printer. Set the lever to the up position (2) of the figure. The insertion of the printer paper is enabled.

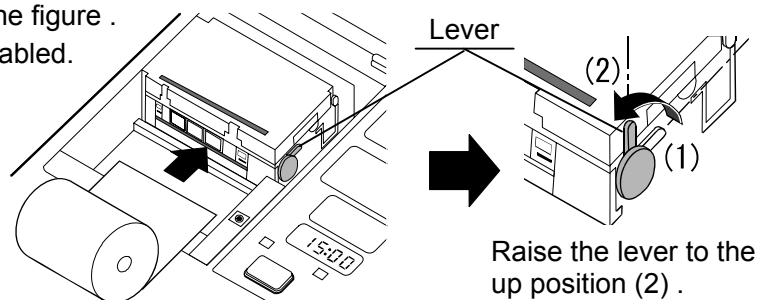

4. Insert the printer paper into the paper feed slot as shown. The paper is fed automatically.

Paper feed slot

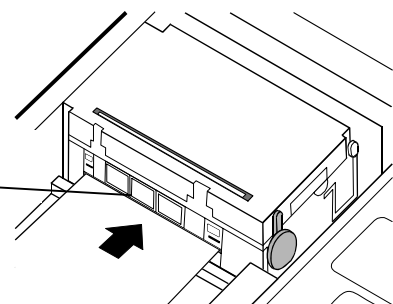

5. Press the PAPER FEED switch to feed the paper by about 10 cm. Confirm that the paper is fed straight. If not, re-install the paper because it may cause a paper jam.

PAPER FEED switch

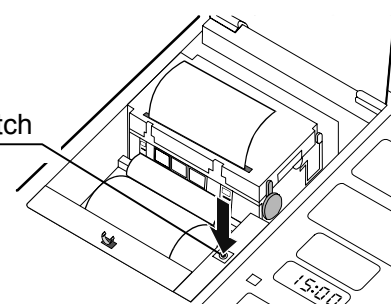

- Lower the lever to the down position (1) .  
Press the PAPER FEED switch again, and confirm that the paper is cut automatically.

**Note**

- Lower the lever for cutting the paper.
- Lower the lever for printing the measurement data.

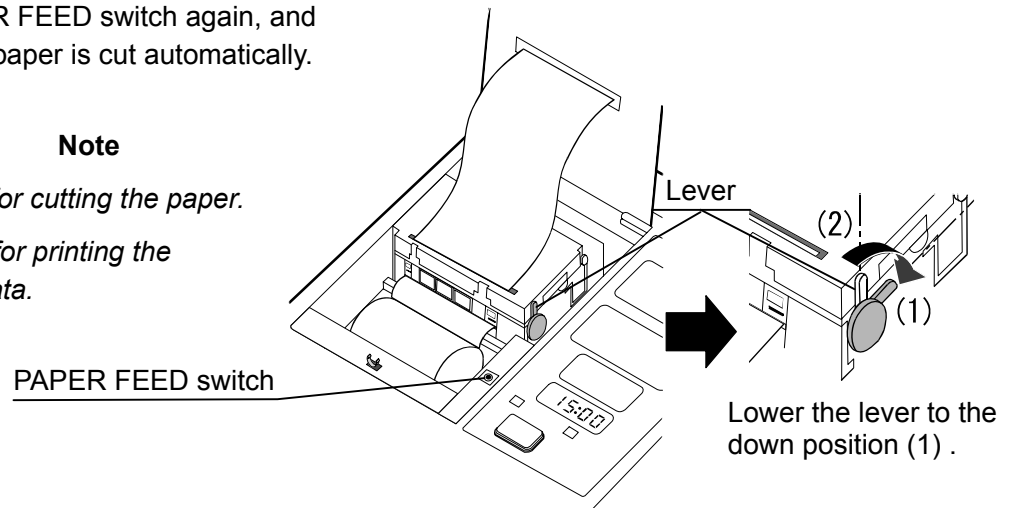

- Remove the printer paper from the paper outlet, and close the cover.  
Press lightly on the center of the printer cover to secure it in position.

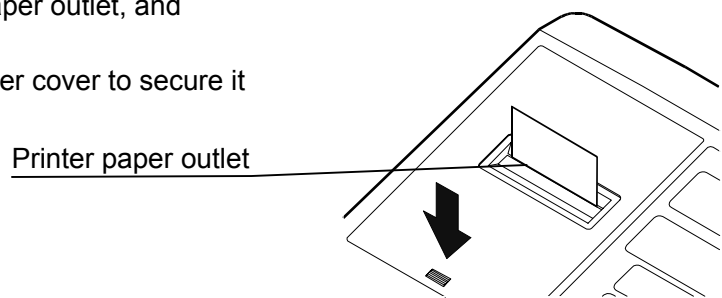

**Note**

- With high-speed printing, about 700 printings can be performed.  
With four-line printing, about 500 printings.
- Replace the printer paper when the red end is reached.
- Use the specified thermal paper, which is sold separately.

Fig.11 Paper installation procedure

# 7. SETTING THE FUNCTIONS

## 7-1 Function Setting Mode

The TM-2655/TM-2655P is provided with various functions, which allow the user to set the device to suit the user's requirements. The functions are set in the function setting mode. The function setting mode display and switches used are as shown below:

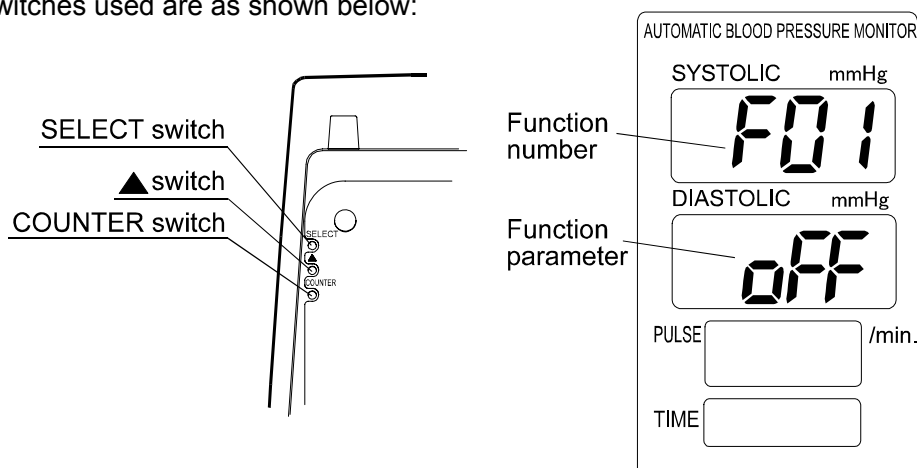

Fig.12 Switches for setting the function and the function setting mode display

Table 4 Switches for setting the functions

▲ switch and SELECT switch	Hold down the ▲ switch and press the SELECT switch to enter the function setting mode.
COUNTER switch	Press to select the function to set.
▲ switch	Press to select the function parameter.

1. Hold down the ▲ switch and press the SELECT switch. "F01" appears in the SYSTOLIC pressure display. This indicates that the monitor is now in the function setting mode.
2. Press the COUNTER switch to select the function number to set. Each time the switch is pressed, the function number changes: from "F01" to "F02" to "F03".
3. Press the ▲ switch to select the function parameter.
4. When the settings are complete, turn the power off and turn it on again. The settings are saved.

## 7-2 Description of the Functions

Table 5 Functions

No.	Function	SYSTOLIC display	DIASTOLIC display	Description
F01	—————	<i>F01</i>	<i>oFF</i>	Not available.
F02	Printer setting (See “7-3 Printing Samples” for what each method printing looks like.)	<i>F02</i>	<i>oFF</i>	No printing
			<i>1</i>	High-speed printing
			<i>2</i>	4-line printing
			<i>3</i>	4-line printing
			<i>4</i>	Graph printing
F03	TM-2655P only	<i>F03</i>	<i>oFF</i>	No bit pattern printing
			<i>oN</i>	Bit pattern printing
F04	Displaying time	<i>F04</i>	<i>999</i>	The results remain in the display unless another operation is performed.
			<i>5</i>	Displays the results for 5 seconds.
			<i>10</i>	Displays the results for 10 seconds.
			<i>20</i>	Displays the results for 20 seconds.
F05	External connection	<i>F05</i>	<i>1</i>	Terminals 1 and 2 to a PC
			<i>2</i>	Terminal 1 to a PC Terminal 2 to a card reader
			<i>3</i>	Terminal 1 to a scale Terminal 2 to a PC
			<i>4</i>	N.A.
F06	Pressurization	<i>F06</i>	<i>Auto</i>	Automatic pressurization
			<i>160</i>	Pressurizes the cuff up to 160 mmHg.
			<i>180</i>	Pressurizes the cuff up to 180 mmHg.
			<i>200</i>	Pressurizes the cuff up to 200 mmHg.
F07	Channel 1 baud rate	<i>F07</i>	<i>120</i>	1200 bps
			<i>240</i>	2400 bps
			<i>480</i>	4800 bps
			<i>960</i>	9600 bps
F08	Channel 2 baud rate	<i>F08</i>	<i>120</i>	1200 bps
			<i>240</i>	2400 bps
			<i>480</i>	4800 bps
			<i>960</i>	9600 bps
F09	—————	<i>F09</i>	<i>H9</i>	Not available.
F10	Human sensor	<i>F10</i>	<i>oFF</i>	Does not detect a human presence.
			<i>oN</i>	Detects a human presence.
F11	Automatic external output	<i>F11</i>	<i>oFF</i>	Does not output the results automatically.
			<i>oN</i>	Outputs the results automatically.

## 7-3 Printing Samples

### High-speed printing

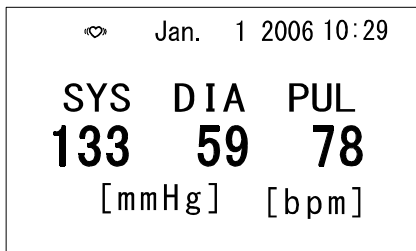

### Graph printing

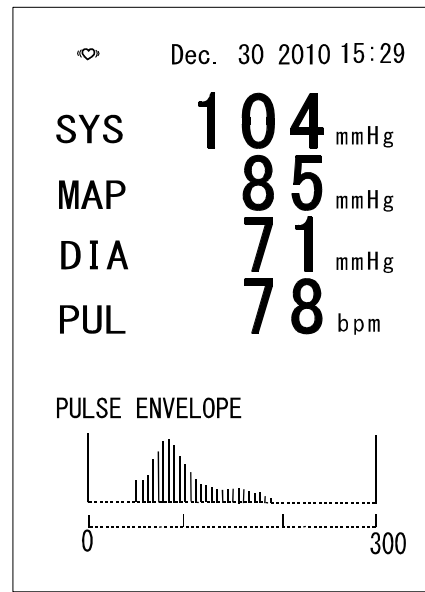

### 4-line printing

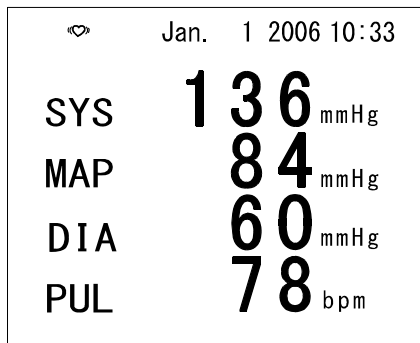

### Table printing

No.	TIME	SYS [mmHg]	DIA [mmHg]	PUL [bpm]
00001	10:49	129	65	78
00002	10:50	135	61	78
00003	10:51	132	61	77

### Bit pattern printing

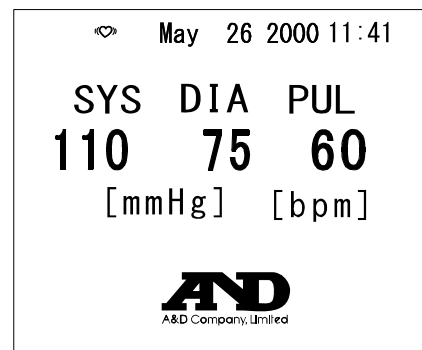

Fig.13 Printing samples

### Note

*Bit pattern printing is available only for the TM-2655P. With this format, some items such as the company name can be printed. For details, contact your nearest dealer.*

*When detecting an irregular heart beat(I.H.B), "♥" is printed.*



# 8. COMMUNICATION SPECIFICATIONS

The TM-2655/TM-2655P is equipped with two RS-232C channels. Various settings for each channel are available in the function setting mode. Refer to “7-2 Description of the Functions” for details.

## 8-1 Channel 1 : Miniature 8-pin DIN

### CAUTION

- The personal computer and medical equipment connected to the device are not allowed to be in the patient area.
- The personal computer used must conform to IEC60950

### Specifications

Table 6 Channel 1 specifications

Standard	Conforms to EIA RS-232C
Transmission	Asynchronous, half-duplex
Baud rate	1200, 2400, 4800, 9600 bps (Can be changed in the function setting mode “F07”.)
Data bits	8 bits
Parity bit	None
Stop bits	1 bit
Code	ASCII

### Equipment available for connection

- Channel 1: Scales, and automatic weight and height scales manufactured by A&D  
 Channel 2: Personal computer

### Pin assignment

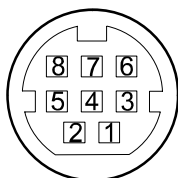

Pin No.	Signal name	Description
1	TXD	Send data
2	RXD	Receive data
3	RTS	Ready to send
4	-	Used internally
5	CTS	Clear to send
6	GND	Signal ground
7	-	Used internally
8	-	Used internally

### Note

Do not use pins 4, 7, and 8.  
They are used by the device.

Fig.14 Pin assignment

### Cable connection between the device and a personal computer

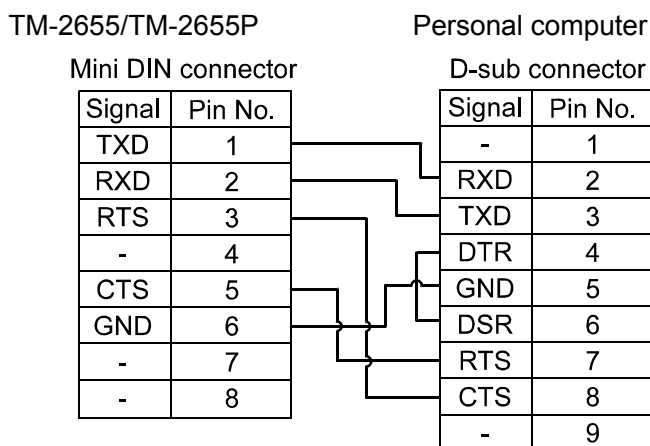

Fig.15 Cable connection diagram

## 8-2 Channel 2: D-sub 9-pin

 **CAUTION**

- The personal computer and medical equipment connected to the device are not allowed to be in the patient area.
- The personal computer used must conform to IEC60950

### Specifications

*Table 7 Channel 2 specifications*

Standard	Conforms to EIA RS-232C
Transmission	Asynchronous, half-duplex
Baud rate	1200, 2400, 4800, 9600 bps (Can be changed in the function setting mode "F08".)
Data bits	8 bits
Parity bit	None
Stop bits	1 bit
Code	ASCII

### Equipment available for connection

Channel 1: Personal computer  
 Channel 2: Card reader

### Pin assignment

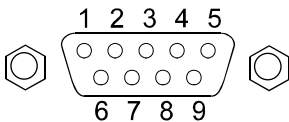

Pin No.	Signal name	Direction	Description
1	-	-	-
2	RXD	In	Receive data
3	TXD	Out	Send data
4	DTR	Out	Data terminal ready
5	GND	-	Signal ground
6	DSR	In	Data set ready
7	RTS	Out	Ready to send
8	CTS	In	Clear to send
9	-	-	-

**Note**  
*The protocol depends on the equipment connected.*

*Fig.16 Pin assignment*

### Cable connection between the device and a personal computer

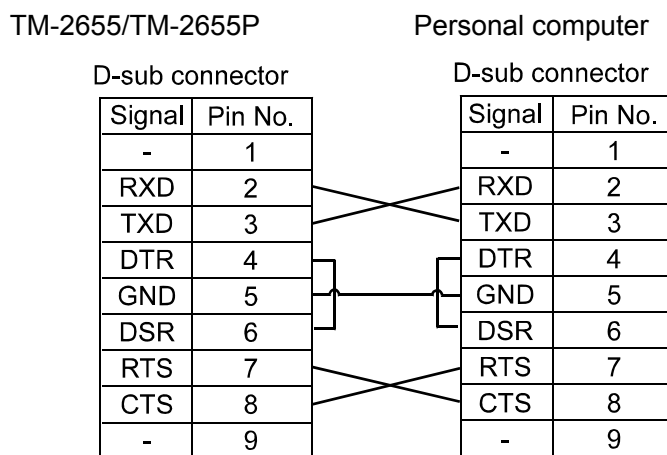

*Fig.17 Cable connection diagram*

# 9. MAINTENANCE

## 9-1 Replacing the Arm Cuff Cover

Replace the arm cuff cover as follows:

1. Locate the cover at the bottom of the arm insertion section. Slide the cover downward to open it. A screw is exposed.

Using the screwdriver, loosen the screw and remove the front frame.

2. Remove the four screws on the rear panel to remove the armrest and the rear panel.

3. Remove the front vinyl ring of the arm cuff cover from the groove. Remove the rear vinyl ring of the arm cuff cover from the groove. Pull out the arm cuff cover.

**Note**

*The vinyl rings will be used to support the new arm cuff cover.*

4. Place a new arm cuff cover in the arm cuff area. Secure the front and rear vinyl rings of the arm cuff cover in the groove. Smooth the cover cloth near the grooves.

5. Replace the rear panel, the armrest, and the front frame in the reversed order of removal. Slide the cover upward to secure it in position.

**Note**

*The arm cuff cover is a consumable. Purchase it separately. Remove the vinyl rings from the old arm cuff and install them in the new arm cuff cover. The vinyl rings are not included with the optional arm cuff cover.*

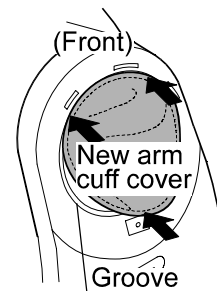
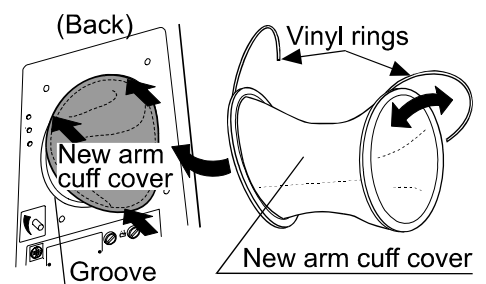
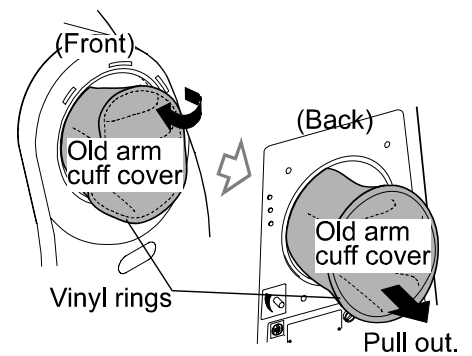
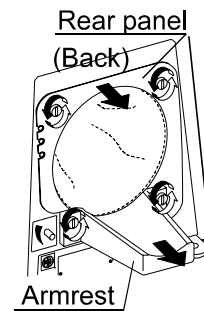
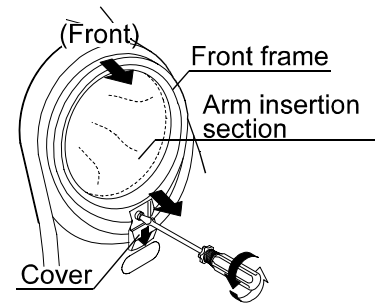

Fig.18 Arm cuff replacing procedure

## 9-2 Replacing the Fuses

Replace the fuses as follows:

1. Remove the caps of both fuse holders located on the rear panel.
2. Replace both fuses with new ones.
3. Re-install the fuse holder caps.

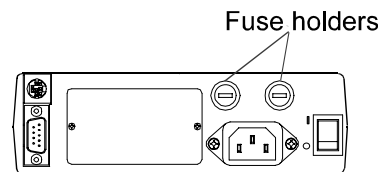

Fig.19 Fuse holders

### Note

Use only fuses of the proper type, voltage and current rating as specified on the rear panel, and that conform to IEC60127.

## 9-3 Checking the Counter

The TM-2655/TM-2655P is equipped with a counter function, which indicates how many times the device has measured blood pressure. The counter data remains in memory even after the power is turned off. Use the counter function to check the frequency of the device use or as the guideline for a periodic cleaning

### Displaying the counter

Press the COUNTER switch. The counter data appears in the SYSTOLIC and DIASTOLIC displays for about 5 seconds.

COUNTER switch

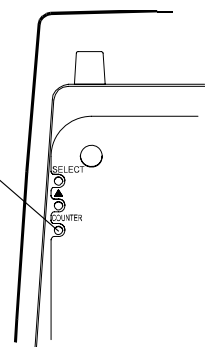

### Note

Do not keep the COUNTER switch pressed. It will reset the counter data to zero.

Ex. The measurement count at the figure is 2382 times.

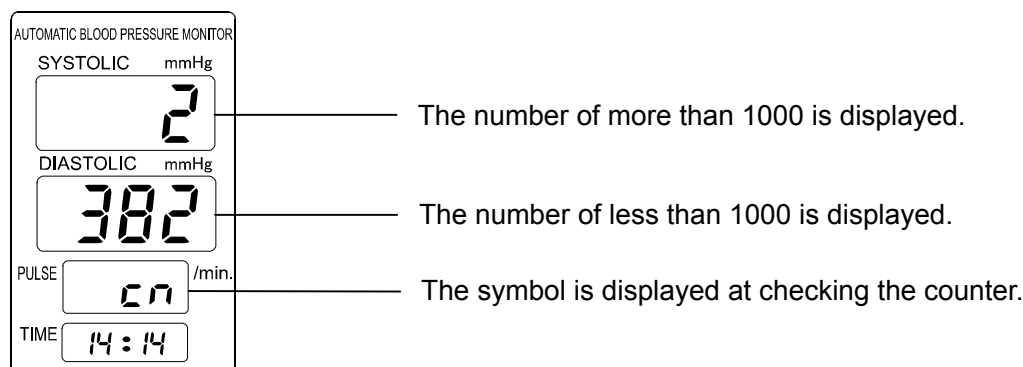

## Resetting the counter

Hold down the COUNTER switch for 4 seconds or more.

The counter data will be reset to zero.

Fig.20 COUNTER switch

## Printing the counter graph

Press and hold the COUNTER switch, press the PAPER FEED switch to display the current measurement count.

Total : The total measurement count of the product.

Weekly Count : The count for last one week.

Monthly Count : The count for last one year.

**Note1:** The Total can not be reset by pressing the COUNTER switch.

**Note2:** When the print selection is "OFF", the counter graph is not printed.

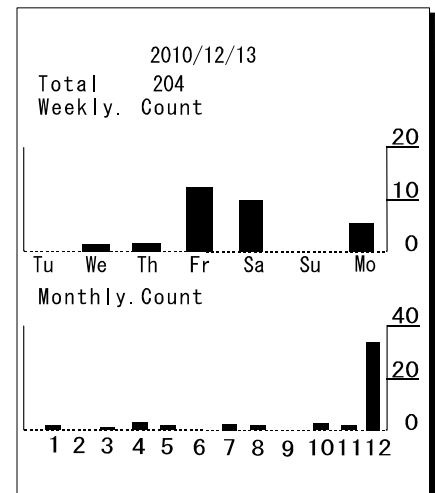

## 9-4 Error Codes

Table 9 Error codes

Error code	Description
PE	The printer paper has run out. Install a new roll of printer paper.
HU	The printer head is up. Lower the lever and lock the printer paper in position.
Err	A measurement error has occurred. Refer to "10. Troubleshooting".

## 9-5 Maintenance

Do not open the device. It uses delicate electronic components and an intricate air unit that could be damaged. If you can not fix the problem using the troubleshooting instructions, request service from your supplier or from the A&D service group. The A&D service group will provide technical information, spare parts and units to authorized suppliers.

The technical testing procedures, which should be done at least every two years, can be performed either by the manufacturer or by an authorized repair service in accordance with the regulations governing manufacturing of medical products.

## 9-6 Cleaning



### CAUTION

- Never immerse the TM-2655/TM-2655P in water for cleaning, that may damage the electronic parts inside.
- Never use thinner or a strong detergent for cleaning, that may discolor or deform the plastic case and display panel.

## Housing case

Clean the case gently using a soft cloth moistened with water and mild detergent or alcohol.

## Display panel

Clean the display gently so as not to scratch the panel surface. Use a soft cloth moistened with water.

## Arm cuff cover

When the arm cuff cover becomes dirty or it is worn out, replace with a new one. Refer to "9-1 Replacing the Arm Cuff Cover".

### Note

*If the cover is not installed properly, it may cause problems in operation.*

## 9-7 Options and Consumables

---

Options and consumables available for the TM-2655/TM-2655P are shown below. Order them from the nearest dealer. Use the part numbers when ordering.

- Table .....TM-9325
- Chair without backrest (Gas shock suspension)···TM-9312A
- Chair with backrest (Gas shock suspension)·····TM-9315A
- Printer paper (5 rolls)······ AX-PP147-S
- Arm cuff cover ..... AX-133003442-S
- Power cable (cord set) ..... AX-KO243 (Type C)
- Power cable (cord set) ..... AX-KO242 (Type BF)
- Power cable (cord set) ..... AX-KO115 (Type A)

# 10. TROUBLESHOOTING

If the TM-2655/TM-2655P does not function properly or an error code appears, try the following corrective actions.

Table 10 Troubleshooting

Problem	Check this	Corrective action
Nothing appears in the display, even when the power is turned on.	Is the power cable connected properly?	Connect the power cable properly.
	Has a fuse burned out?	Replace both fuses with new ones. (Size 5x20mm. Rated voltage and current are specified on the rear panel).
"E00" appears in the display.	Does air remain in the cuff?	After releasing the air from the cuff, wait a few seconds and turn the power switch on again.
"E98" appears in the display.	_____	The cuff motor did not function, or Cuff motor malfunction. Contact the local A&D dealer to repair the device.
"E99" appears in the display.	_____	The home position of the cuff cannot be detected. Turn on the power switch again.
The cuff will not inflate.	Is the arm cuff cover installed with high tension (too tight)?	Refer to "9-1 Replacing the Arm Cuff Cover" to re-install the cover.
The device will not measure. ( <i>Err</i> appears.)	Is your posture proper?	Place your arm at your heart level, relax and remain still during the measurement.
	Do you remain still?	Do not move your arm during the measurement. Relax and remain still.
	_____	Wearing a thick jacket may cause a faint pulse, and result in a measurement error. Take off the jacket.
	_____	This device bases its measurements on the heartbeat. If you have a very weak or irregular heartbeat, the device may have difficulty determining your blood pressure.
The printer does not print.	Is the printer paper installed? ( <i>PE</i> appears.)	Refer to "6. INSTALLING THE PRINTER PAPER" to install the printer paper.
	Is the printer head up? ( <i>HU</i> appears.)	Lower the lever and lock the printer paper in position
	Is the printer paper inserted straight or is the printer paper jammed?	Refer to "6. INSTALLING THE PRINTER PAPER" to re-install the printer paper.
	Is the printer setting correct?	Refer to "7-2 Description of the Functions" to select the correct printer setting.

**Note**

*If the actions described above do not solve the problem, contact the dealer. Do not attempt to repair the device yourself.*

# 11. EXTERNAL DIMENSIONS

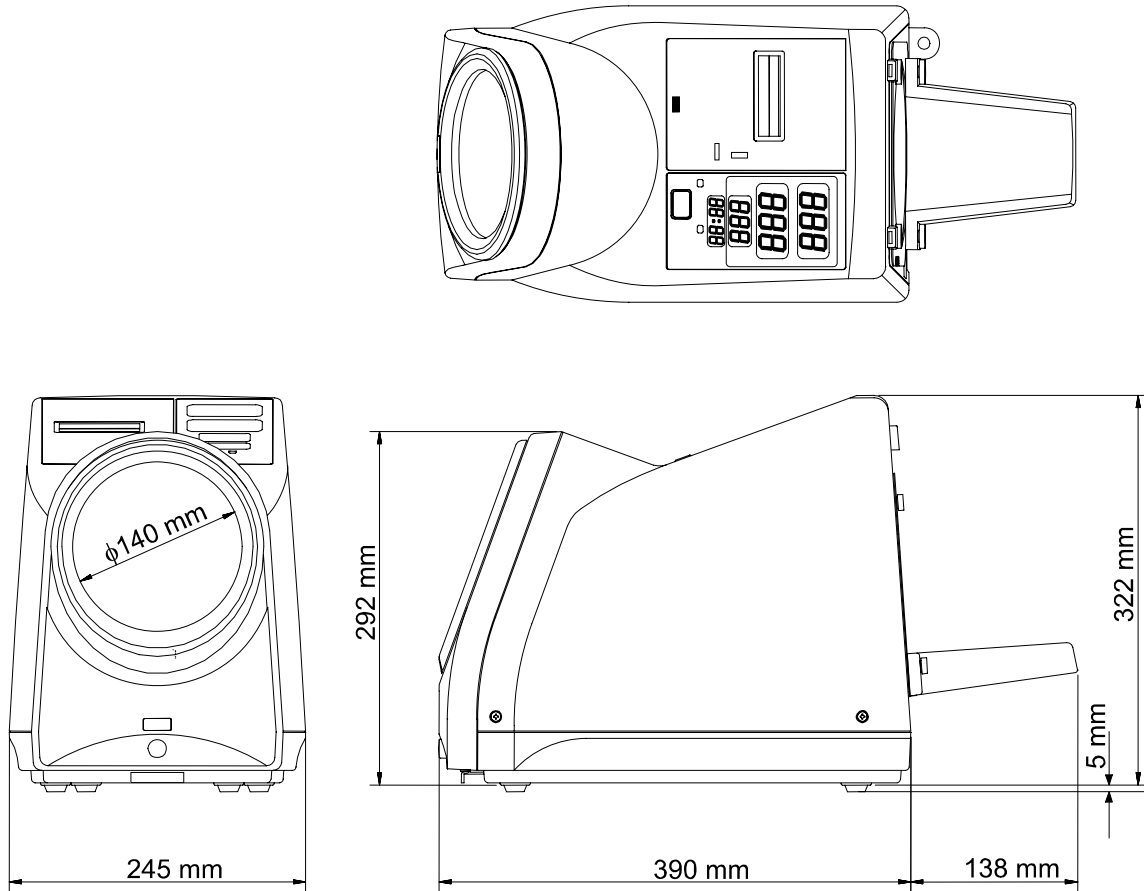

Fig.20 External dimensions

## Note

The illustration above indicates the TM-2655P with the printer unit. The dimensions are the same for the TM-2655 and TM-2655P.



## APPENDIX: EMC INFORMATION

Medical Electrical Equipment needs special precautions regarding EMC and needs to be installed and put into service according to the EMC information provided in the following.

Portable and mobile RF communication equipment (e.g. cell phones) can affect Medical Electrical Equipment.

The use of accessories and cables other than those specified (other than A&D original parts) may result in increased emissions or decreased immunity of the unit.

<b>Guidance and manufacturer's declaration – electromagnetic emissions</b>		
The A&D unit is intended for use in the electromagnetic environment specified below. The customer or the user of the A&D unit should assure that it is used in such an environment.		
<b>Emissions test</b>	<b>Compliance</b>	<b>Electromagnetic environment – guidance</b>
RF emissions CISPR 11	Group 1	The A&D unit uses RF energy only for its internal function. Therefore, its RF emissions are very low and are not likely to cause any interference in nearby electronic equipment.
RF emissions CISPR 11	Class A	The A&D unit is suitable for use in all establishments, including domestic establishments and those directly connected to the public low-voltage power supply network that supplies buildings used for domestic purposes.
Harmonic emissions IEC 61000-3-2	Class A	
Voltage fluctuations/flicker emissions IEC 61000-3-3	Complies	

<b>Recommended separation distances between portable and mobile RF communications equipment and the A&amp;D unit</b>			
The A&D unit is intended for use in an electromagnetic environment in which radiated RF disturbances are controlled. The customer or the user of the A&D unit can help prevent electromagnetic interference by maintaining a minimum distance between portable and mobile RF communications equipment (transmitters) and the A&D unit as recommended below, according to the maximum output power of the communications equipment.			
<b>Rated maximum output power of transmitter</b>	<b>Separation distance according to frequency of transmitter</b>		
	<b>m</b>		
W	<b>150 kHz to 80 MHz</b> $d = 1.2\sqrt{P}$	<b>80 MHz to 800 MHz</b> $d = 1.2\sqrt{P}$	<b>800 MHz to 2.5 GHz</b> $d = 2.3\sqrt{P}$
0.01	0.12	0.12	0.23
0.1	0.38	0.38	0.73
1	1.2	1.2	2.3
10	3.8	3.8	7.3
100	12	12	23
For transmitters rated at a maximum output power not listed above, the recommended separation distance $d$ in metres (m) can be estimated using the equation applicable to the frequency of the transmitter, where $p$ is the maximum output power rating of the transmitter in watts (W) according to the transmitter manufacturer.			
NOTE 1 At 80 MHz and 800 MHz, the separation distance for the higher frequency range applies.			
NOTE 2 These guidelines may not apply in all situations. Electromagnetic propagation is affected by absorption and reflection from structures, objects and people.			

**Guidance and manufacturer's declaration – electromagnetic immunity**

The A&D unit is intended for use in the electromagnetic environment specified below. The customer or the user of the A&D unit should assure that it is used in such an environment.

Immunity test	IEC 60601 test level	Compliance level	Electromagnetic environment – guidance
<p>Conducted RF IEC 61000-4-6</p> <p>Radiated RF IEC 61000-4-3</p>	<p>3 V<sub>rms</sub> 150 kHz to 80 MHz</p> <p>3 V/m 80 MHz to 2,5 GHz</p>	<p>3 V<sub>rms</sub></p> <p>3 V/m</p>	<p>Portable and mobile RF communications equipment should be used no closer to any part of the A&amp;D unit, including cables, than the recommended separation distance calculated from the equation applicable to the frequency of the transmitter.</p> <p><b>Recommended separation distance:</b></p> $d = 1.2 \sqrt{P}$ $d = 1.2 \sqrt{P} \quad 80 \text{ MHz to } 800 \text{ MHz}$ $d = 2.3 \sqrt{P} \quad 800 \text{ MHz to } 2,5 \text{ GHz}$ <p>where <i>P</i> is the maximum output power rating of the transmitter in watts (W) according to the transmitter manufacturer and <i>d</i> is the recommended separation distance in metres (m).</p> <p>Field strengths from fixed RF transmitters, as determined by an electromagnetic site survey,<sup>a</sup> should be less than the compliance level in each frequency range.<sup>b</sup></p> <p>Interference may occur in the vicinity of equipment marked with the following symbol: </p>

NOTE 1 At 80 MHz and 800 MHz, the higher frequency range applies.

NOTE 2 These guidelines may not apply in all situations. Electromagnetic propagation is affected by absorption and reflection from structures, objects and people.

<sup>a</sup> Field strengths from fixed transmitters, such as base stations for radio (cellular/cordless) telephones and land mobile radios, amateur radio, AM and FM radio broadcast and TV broadcast cannot be predicted theoretically with accuracy. To assess the electromagnetic environment due to fixed RF transmitters, an electromagnetic site survey should be considered. If the measured field strength in the location in which the A&D unit is used exceeds the applicable RF compliance level above, the A&D unit should be observed to verify normal operation. If abnormal performance is observed, additional measures may be necessary, such as re-orienting or relocating the A&D unit.

<sup>b</sup> Over the frequency range 150 kHz to 80 MHz, field strengths should be less than 3 V/m.

**Guidance and manufacturer's declaration – electromagnetic immunity**

The A&D unit is intended for use in the electromagnetic environment specified below. The customer or the user of the A&D unit should assure that it is used in such an environment.

<b>Immunity test</b>	<b>IEC 60601 test level</b>	<b>Compliance level</b>	<b>Electromagnetic environment – guidance</b>
Electrostatic discharge (ESD) IEC 61000-4-2	± 6 kV contact  ± 8 kV air	± 6 kV contact  ± 8 kV air	Floors should be wood, concrete or ceramic tile. If floors are covered with synthetic material, the relative humidity should be at least 30%.
Electrical fast transient/burst IEC 61000-4-4	± 2 kV for power supply lines  ± 1 kV for input/output lines	± 2 kV for power supply lines  ± 1 kV for input/output lines	Mains power quality should be that of a typical commercial or hospital environment.
Surge IEC 61000-4-5	± 1 kV line to line  ±2 kV line to earth	± 1 kV line to line  ±2 kV line to earth	Mains power quality should be that of a typical commercial or hospital environment.
Voltage dips, short interruptions and voltage variations on power supply input lines IEC 61000-4-11	< 5% $U_T$ (> 95% dip in $U_T$ ) for 0.5 cycle  40% $U_T$ (60% dip in $U_T$ ) for 5 cycles  70% $U_T$ (30% dip in $U_T$ ) for 25 cycles  < 5% $U_T$ (> 95% dip in $U_T$ ) for 5 s	< 5% $U_T$ (> 95% dip in $U_T$ ) for 0.5 cycle  40% $U_T$ (60% dip in $U_T$ ) for 5 cycles  70% $U_T$ (30% dip in $U_T$ ) for 25 cycles  < 5% $U_T$ (> 95% dip in $U_T$ ) for 5 s	Mains power quality should be that of a typical commercial or hospital environment. If the user of the A&D unit requires continued operation during power mains interruptions, it is recommended that the A&D unit be powered from an uninterruptible power supply or a battery.
Power frequency (50/60 Hz) magnetic field IEC 61000-4-8	3 A/m	3 A/m	Power frequency magnetic fields should be at levels characteristic of a typical location in a typical commercial or hospital environment.

NOTE :  $U_T$  is the AC mains voltage prior to application of the test level.











 **A&D Company, Limited**

1-243 Asahi , Kitamoto-shi, Saitama 364-8585, JAPAN  
Telephone: [81] (48) 593-1111 Fax: [81] (48) 593-1119

 **A&D INSTRUMENTS LIMITED**

Unit 24/26 Blacklands Way, Abingdon Business Park, Abingdon, Oxfordshire OX14 1DY United Kingdom  
Telephone: [44] (1235) 550420 Fax: [44] (1235) 550485

**A&D ENGINEERING, INC.**

1756 Automation Parkway, San Jose, California 95131, U.S.A.  
Telephone: [1] (408) 263-5333 Fax: [1] (408)263-0119

**A&D AUSTRALASIA PTY LTD**

32 Dew Street, Thebarton, South Australia 5031, AUSTRALIA  
Telephone: [61] (8) 8301-8100 Fax: [61] (8) 8352-7409

**ООО A&D RUS**

**ООО "ЭЙ энд ДИ РУС"**

121357, Российская Федерация, г.Москва, ул. Верейская, дом 17  
( Business-Center "Vereyskaya Plaza-2" 121357, Russian Federation, Moscow, Vereyskaya Street 17 )  
тел.: [7] (495) 937-33-44 факс: [7] (495) 937-55-66

**A&D Technology Trading(Shanghai) Co. Ltd**

**爱安德技研贸易(上海)有限公司**

中国 上海市浦东新区浦东大道138号永华大厦21楼A室 邮编200120  
( 21F Room A, Majesty Building, No.138 Pudong Avenue, Pudong New Area, Shanghai, 200120, China )  
电话: [86] (21) 3393-2340 传真: [86] (21) 3393-2347