

TM-2480

TM-2481

INSTRUCTION MANUAL

Printer Terminal

AND

A&D Company, Limited



This is a hazard alert mark.



This mark informs you about the operation of the product.

Note This manual is subject to change without notice at any time to improve the product. No part of this manual may be photocopied, reproduced, or translated into another language without the prior written consent of the A&D Company.

Product specifications are subject to change without any obligation on the part of the manufacture.









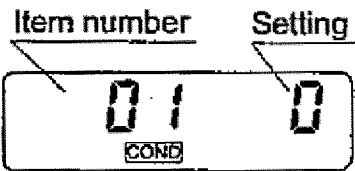
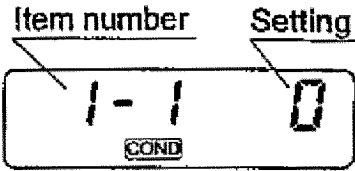
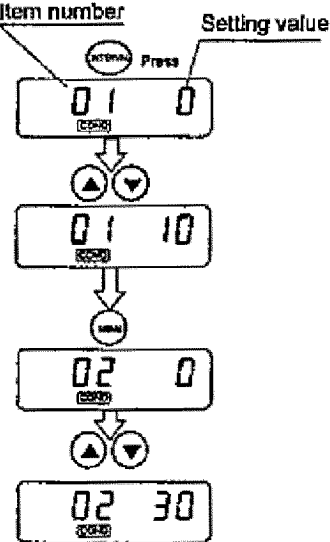
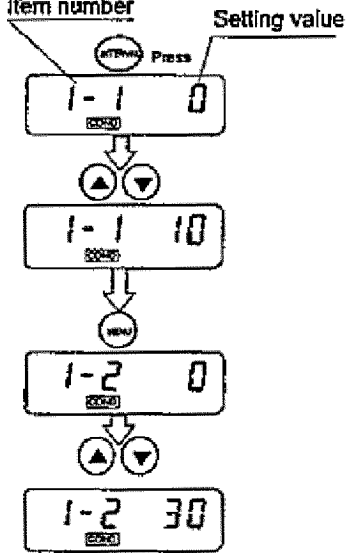















Copyright©1999 A&D Company, Limited

Windows and EXCEL are registered trademarks of Microsoft Corporation.
Macintosh is registered trademarks of Apple Computer, Inc. .
UNIX is registered trademarks of Sun Microsystems, Inc. .

Correction Sheet

This is correction sheet for the printer terminal instruction manual of TM-2480 and TM-2481, version 1600-1A-IE.

Page	Incorrect	Correct																										
42	<p>10.3.4 Alarm Setting for Measurement Time</p> 	<p>10.3.4 Alarm Setting for Measurement Time</p> 																										
42	<table border="1" data-bbox="459 825 683 1300"> <thead> <tr> <th>Item number</th> </tr> </thead> <tbody> <tr><td>01</td></tr> <tr><td>02</td></tr> <tr><td>03</td></tr> <tr><td>04</td></tr> <tr><td>05</td></tr> <tr><td>06</td></tr> <tr><td>07</td></tr> <tr><td>08</td></tr> <tr><td>09</td></tr> <tr><td>10</td></tr> <tr><td>11</td></tr> <tr><td>12</td></tr> </tbody> </table>	Item number	01	02	03	04	05	06	07	08	09	10	11	12	<table border="1" data-bbox="962 825 1177 1300"> <thead> <tr> <th>Item number</th> </tr> </thead> <tbody> <tr><td>1-1</td></tr> <tr><td>1-2</td></tr> <tr><td>2-1</td></tr> <tr><td>2-2</td></tr> <tr><td>3-1</td></tr> <tr><td>3-2</td></tr> <tr><td>4-1</td></tr> <tr><td>4-2</td></tr> <tr><td>5-1</td></tr> <tr><td>5-2</td></tr> <tr><td>6-1</td></tr> <tr><td>6-2</td></tr> </tbody> </table>	Item number	1-1	1-2	2-1	2-2	3-1	3-2	4-1	4-2	5-1	5-2	6-1	6-2
Item number																												
01																												
02																												
03																												
04																												
05																												
06																												
07																												
08																												
09																												
10																												
11																												
12																												
Item number																												
1-1																												
1-2																												
2-1																												
2-2																												
3-1																												
3-2																												
4-1																												
4-2																												
5-1																												
5-2																												
6-1																												
6-2																												
43																												

Page	Incorrect	Correct																
9		<p>Symbols</p> <table border="1"> <tr> <td data-bbox="870 556 980 628"></td> <td data-bbox="980 556 1398 628">Turning on / off the recorder.</td> </tr> <tr> <td data-bbox="870 628 980 701"></td> <td data-bbox="980 628 1398 701">Direct current.</td> </tr> <tr> <td data-bbox="870 701 980 773"></td> <td data-bbox="980 701 1398 773">Alternating current.</td> </tr> <tr> <td data-bbox="870 773 980 845"></td> <td data-bbox="980 773 1398 845">Date of manufacture.</td> </tr> <tr> <td data-bbox="870 845 980 917"></td> <td data-bbox="980 845 1398 917">Attention symbol. "See instruction for use".</td> </tr> <tr> <td data-bbox="870 917 980 989"></td> <td data-bbox="980 917 1398 989">Class II equipment.</td> </tr> <tr> <td data-bbox="870 989 980 1061"></td> <td data-bbox="980 989 1398 1061">CE marking.</td> </tr> <tr> <td data-bbox="870 1061 980 1133"></td> <td data-bbox="980 1061 1398 1133">Serial number.</td> </tr> </table>		Turning on / off the recorder.		Direct current.		Alternating current.		Date of manufacture.		Attention symbol. "See instruction for use".		Class II equipment.		CE marking.		Serial number.
	Turning on / off the recorder.																	
	Direct current.																	
	Alternating current.																	
	Date of manufacture.																	
	Attention symbol. "See instruction for use".																	
	Class II equipment.																	
	CE marking.																	
	Serial number.																	

Note:

The following function is disabled on the TM-2480/TM-2481 Printer Terminal.

On the UA PC series (MODEL 2), the alarm setting function is disabled.

Related pages :

Chap. 10.3 Model 2, Operation and Setting – page 37 (shown below)

Chap. 10.3.4 Alarm Settings for Measurement Time – page 42

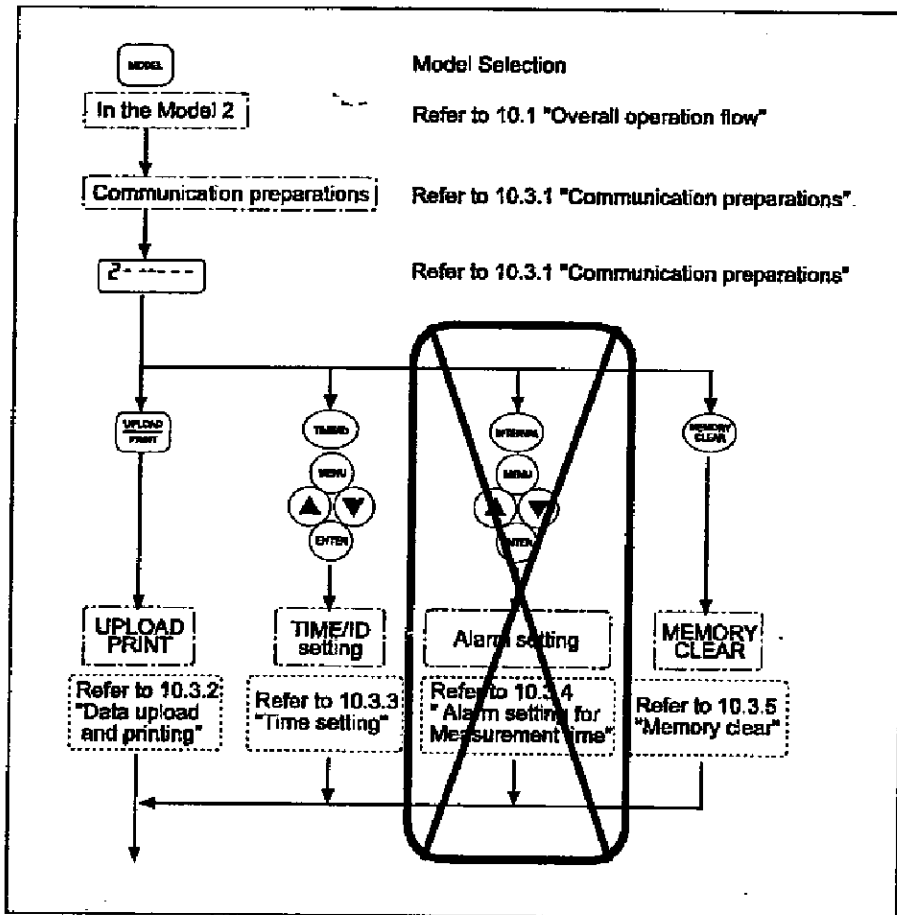

Contents

1.	Compliance	3
1.1.	Compliance with European Directive 93/42 EEC for Medical Product ...	3
1.2.	Compliance with FCC Rules	3
2.	Safety	3
3.	Packing list	4
4.	Introduction	5
5.	Features	5
6.	Specifications	7
7.	Part Names	8
8.	Explanation of Key Switches	10
9.	Preparation	11
9.1.	Cable Connection	11
9.2.	Power (AC adapter or batteries)	11
9.3.	Printer Paper Installation (Replacement)	12
10.	The Whole Operation	13
10.1.	The Whole Operation	13
10.1.1.	Model Selection	16
10.2.	Model 1, Operation and Setting	18
10.2.1.	Communication Preparations	20
10.2.2.	Data Upload and Printing	22
10.2.3.	Print Format Setting	24
10.2.4.	Time/ID Setting	26
10.2.5.	Measurement Interval Setting	28
10.2.5.1.	Setting of Automatic Measurement Mode III	30
10.2.6.	Memory Clear	35
10.2.7.	Printing of Setting Content	36
10.3.	Model 2, Operation and Setting	36
10.3.1.	Communication Preparations	37
10.3.2.	Data Upload and Printing	39

10.3.3.	Time Setting	40
10.3.4.	Alarm Setting for Measurement Time	42
10.3.5.	Memory Clear	44
10.3.6.	Printing of Setting List	45
10.4.	Model 3, Operation and Setting	46
10.4.1.	Communication Preparations	47
10.4.2.	Data Upload and Printing	48
11.	Maintenance	49
11.1.	Cleaning	49
11.2.	Before Requesting Repairs	49
12.	Options	50
13.	Appendix	50
13.1.	External Diagrams	50
13.2.	Printout Examples	52

1. Compliance

1.1. Compliance with European Directive 93/42 EEC for Medical Product

The device conforms to European Directive 93/42 EEC for Medical Products. This is evidenced by the CE mark of conformity accompanied by the reference number of a designated authority.

1.2. Compliance with FCC Rules

This device complies with Part 15 of the FCC Rules. Operation is subject to the following two conditions: (1) This device may not cause harmful interference, and (2) this device must accept any interference received, including interference that may cause undesired operation. (FCC = Federal Communications Commission in the U.S.A.)

2. Safety

Caution

Printer Terminal

- Be sure to read the instruction manual of the connected blood pressure monitor before use.

Batteries

- Use alkaline batteries in the printer. Use of other types of batteries may cause reduced printer performance, damage, or fire.
- Do not mix and use old and new batteries.
- When the printer will not be used for a long period of time, remove the batteries. Batteries kept in the printer for a long period may leak and cause damage.

Storage Location

- Do not store the printer in :
- Locations where water or other fluids may get on or into the printer.
 - Locations with high temperature or humidity.
 - Locations in direct sunlight.
 - Locations where the printer will be subject to excessive vibration or shocks.
 - Locations with dust, salt, sulfur, or other contaminants.

Repair

Do not allow the case to be opened by anyone other than authorized service personnel. This will void the warranty and may cause damage to the printer or fires. When repairs are necessary, contact the retailer where you purchased this product or yours nearest A & D representative.

Cleaning

When the printer terminal requires cleaning, gently wipe with a cloth dampened with water or a neutral cleanser.

3. Packing list

Package Content

Confirm that the following items are in the package.

Printer terminal	
Thermal paper:	1 roll
Communication cable:	1
AC adapter:	1
Instruction manual:	1

4. Introduction

Thank you for purchasing the Printer Terminal (TM-2480/TM-2481) from A & D. This manual was written for the TM-2480/TM-2481. Please read the manual carefully before using the unit in order to ensure a sufficient understanding of the printer terminal and provide proper use. Store the manual in a readily available location.

5. Features

- The printer can be used both ambulatory blood pressure monitors and blood pressure monitors used in the home.
- Blood pressure measurement results can easily be printed.
- The TM-2481 has an infrared communication function.
- When an ambulatory blood pressure monitor with infrared communication functions is used, measurement data can be transferred without a cable (TM-2481 only).
- The settings of clock and automatic measurement functions can also be input in blood pressure monitors.
- Applicable blood pressure monitors of the TM-2430 series.
 - The TM-2430 series is "The portable automatic blood pressure monitors".
 - Every 24 hours the unit statistically processes blood pressure, pulse, and pressure load data and then prints the results.
 - Every 24 hours the blood pressure, pulse, and pressure load data are printed as trend graphs.
 - Statistical processing is done to calculate the average value and standard deviation for systolic pressure, diastolic pressure, and pulse rate. The results are then printed.
 - The pressure load is calculated for systolic and diastolic pressure using a surface area that exceeds a freely set value. (Units: mmHg•h)
 - The basic period for statistical processing is 24 hours. Results can also be printed for interval blocks and freely set waking and sleeping periods.

- Applicable blood pressure monitors of the TM-2431 series.
The TM-2431 is "The portable blood pressure monitor with infrared communication function".
 - Data can be read and settings made through infrared communications without a cable connection (TM-2481 only).

- Applicable blood pressure monitors of the UA PC series and UB PC series.
The UA PC series is "Principally upper arm blood pressure monitor for family use" and the UB PC series is "Wrist blood pressure monitor for family use".
 - Every month the unit statistically processes blood pressure data and pulse data and then prints the results.
 - Every month the blood pressure data and pulse data are printed as trend graphs.
 - Statistical processing is done to calculate the average value and standard deviation for systolic pressure, diastolic pressure, and pulse rate. The results are then printed.
 - The number of times the systolic/diastolic pressure exceeds 140/90 is counted. When measurement data for two months or more is present, all blood pressure data is printed. Then all blood pressure trend graphs are printed. Finally, all pulse data trend graphs are printed.

6. Specifications

Power	AC adapter or 6 x alkaline batteries (type LR6, type AA, Mignon)
Power consumption	9.6W max.
Display	LCD
Printer	Serial thermal printer
Print speed	Approx. 1line/sec.
Printer paper	50mm diameter X 58mm width
Communication functions	Serial communications: EIA RS232C standard based Infrared communications: IrDA SIR1.0 standard based (TM2481 only)
Operating temperature and humidity ranges	+10 ~ +40°C 85%RH or less (however, there must be no condensation)
Storage temperature and humidity ranges	-10 ~ +55°C 95%RH (however, there must be no condensation)
External dimensions	TM-2480: Approx. 220mm (W) X 130mm (D) X 85mm (H) TM-2481: Approx. 220mm (W) X 180mm (D) X 90mm (H)
Weight	TM-2480: 530g TM-2481: 580g
Accessories	Printer paper, communication cable, AC adapter

7. Part Names

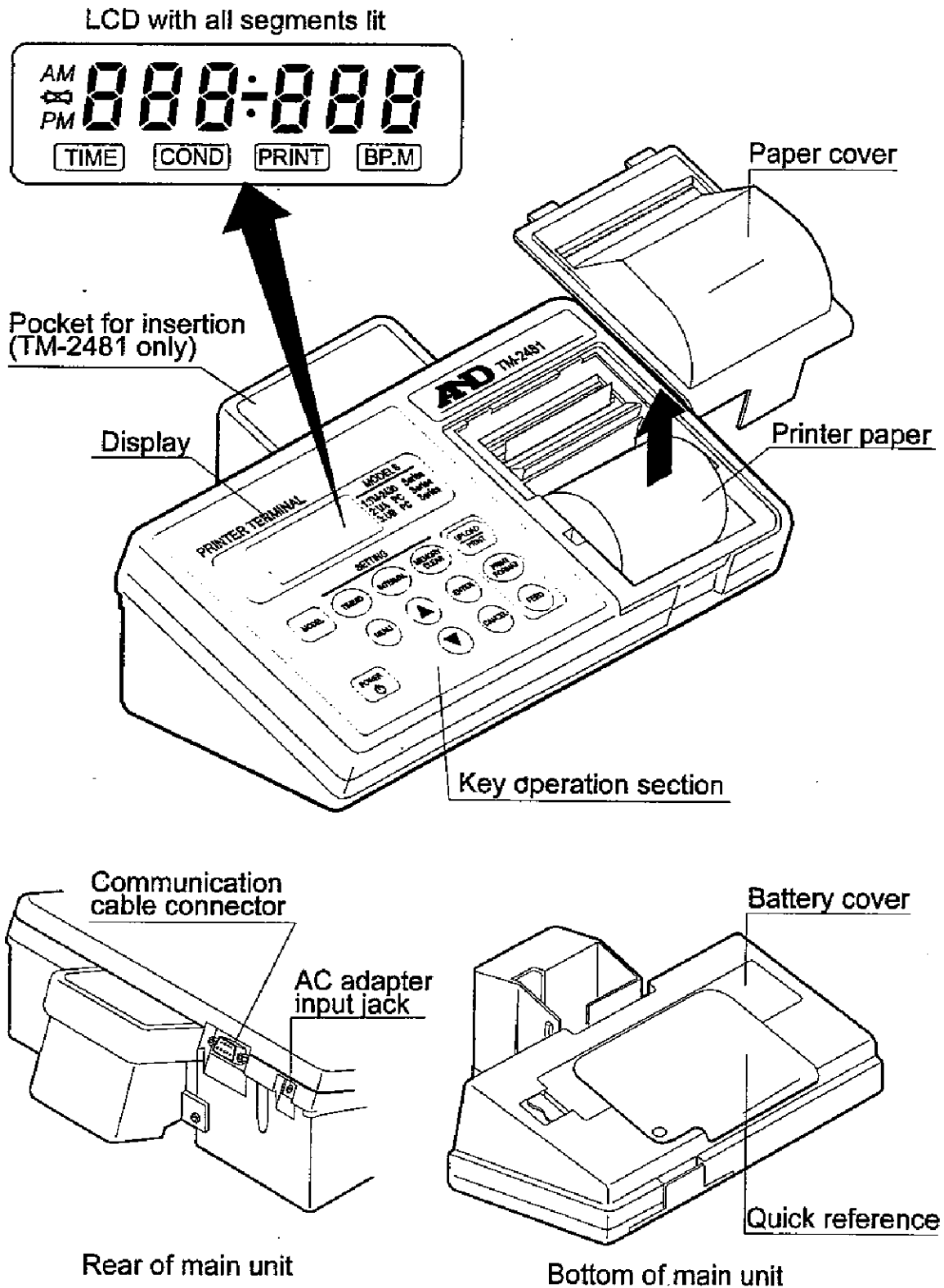

Connected Model Display

When the power switch is turned on, the LCD will blink and then enter the standard mode, as shown below. The number at the left of the LCD at this time shows the model number of the blood pressure monitor. The correlation between model numbers and model names is shown in the table below.

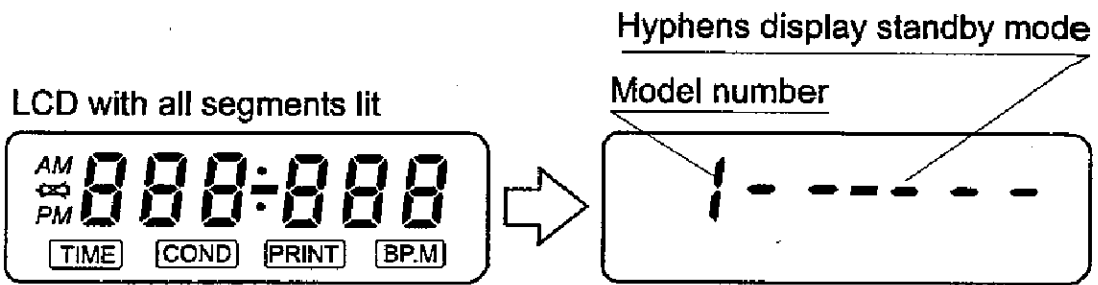

Correlation between Model Numbers and Model Names

Model number	Model name
1	TM-2430 Series
2	UA PC Series
3	UB PC Series

Explanation of Display Marks

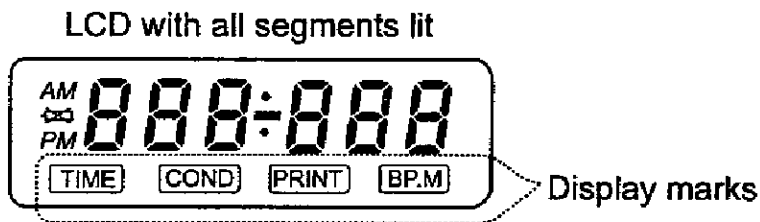

Display mark	Explanation
TIME	Displayed when setting the time or ID (applicable to model numbers 1 and 2).
COND	Displayed when setting the measurement interval (applicable to model numbers 1 and 2).
PRINT	Displayed when setting the report format (applicable to model number 1).
PRINT	Blinks during printing.
BPM	Displayed when measurement data has been uploaded.

Note: Unless this is a back light display, it can not flash.

Low Battery Indicator

When the battery voltage drops during use, the "Lb" is displayed. Replace new batteries or use the AC adapter.



8. Explanation of Key Switches

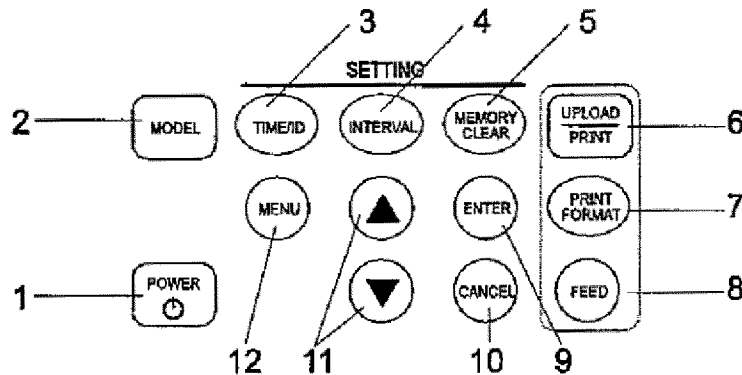

Number	Key	Explanation
1		Turns the power on and off.
2		Selects the connected blood pressure monitor model.
3		Enters the mode for setting time and ID.
4		Enters the mode for setting the measurement interval.
5		Clears the measurement data memory of the blood pressure monitor.
6		Uploads measurement data from the blood pressure monitor. Printing is then done using the report format in memory.
7		Used to enter the mode for setting the report format.
8		Feeds printer paper.
9		Inputs setting changes when in a setting mode.
10		Cancels communications, printing, or settings.
11		Changes setting values when in a setting mode.
12		Selects the item to be changed when in a setting mode.

9. Preparation

Perform the following preparations before using the printer.

9.1. Cable Connection

If you use the infrared communication, it is not necessary to connect the cable.

Step 1 Insert the communication cable into the communication cable connector on the back of the main printer unit, and secure the cable.

Notice

- When connecting the UB PC Series, the cable is different. In this case, use the special communications adapter to connect the cable.
- There are some shapes regarding the accessory cable.

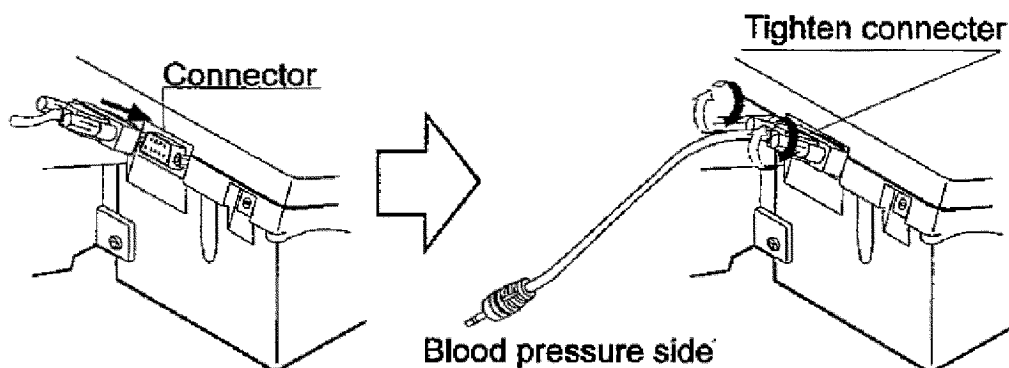

9.2. Power (AC adapter or batteries)

This printer can use batteries or the AC adapter.

Using the AC Adapter

When using the AC adapter, refer to the diagram at right and insert the accessory AC adapter into the AC adapter input jack on the back of the printer. Plug the other end of the adapter into a wall socket.

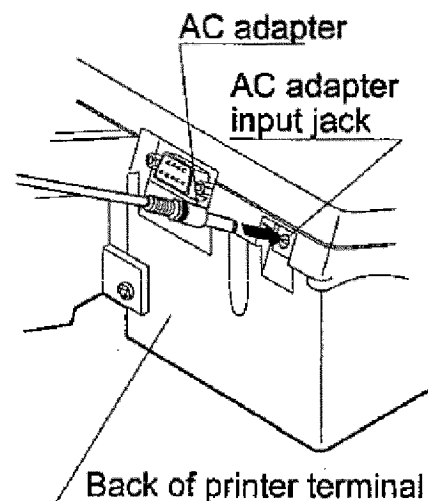

Using Batteries

When using batteries, turn the printer over, refer to the diagram at right, and remove the battery holder from the printer terminal. Follow the arrows in the diagram to put in the batteries.

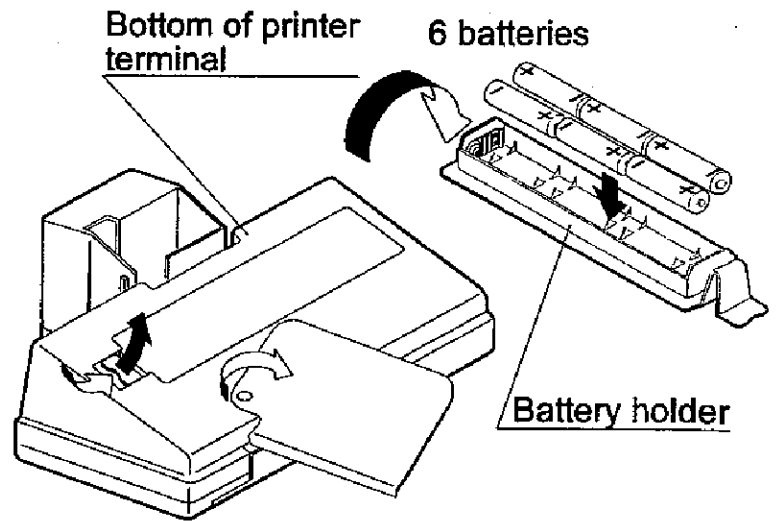

⚠ Caution!

- Put in the batteries properly according to the + and - signs displayed on the holder.
- Replace all batteries when replacement is necessary.
- Do not use different types of batteries together.
- When the printer will not be used for a long time, remove the batteries to avoid damage from leakage.
- When using batteries, the printer terminal is automatically turned off by the auto-power-off function.

9.3. Printer Paper Installation (Replacement)

Notice

- This printer uses thermal paper. Use only the specified printer paper.
- When only 60cm of paper remains, the pink end marker will appear. Replace the paper at this time.

Printer Paper Installation Method

Step 1 Remove the paper cover.

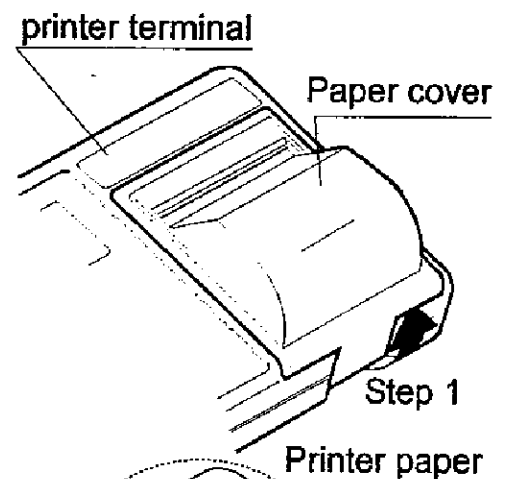

Step 2 Cut the end of the printer paper as shown in the diagram at right.

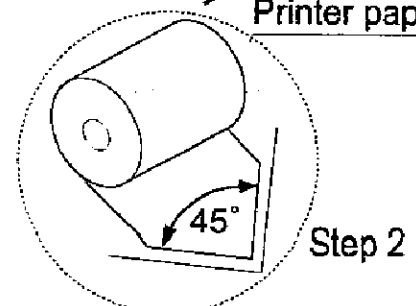

Step 3 Insert the end into the specified position.

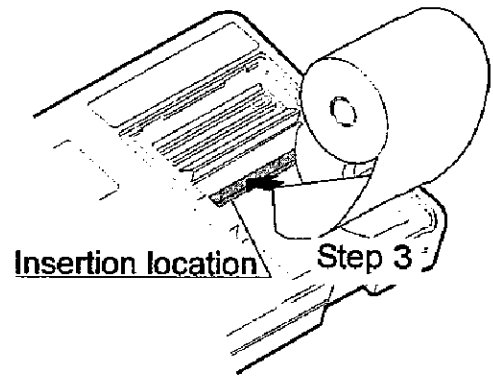

Step 4 When the end comes out of the printer, pull slowly.

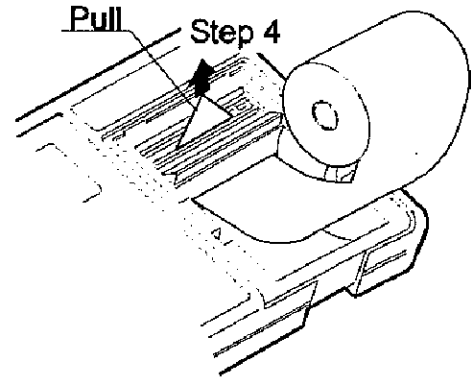

Step 5 When the entire cut portion of the end is visible, press the FEED key and confirm that the paper is fed properly. If the paper is not fed properly, repeat the process from step 2.

Step 6 If the paper feeds properly, replace the paper cover over the printer paper and secure.

10. The Whole Operation

10.1. The Whole Operation

The overall operation flow is shown here for model 1 (TM-2430 series). Be sure to properly understand this flow when using the units.

Although the flow is the same for other units, refer to the operation and setting sections for a detailed explanation.

- Step 1. Connect the cable
Refer to section 9.1 "Cable Connection".
- Step 2. Connect the AC adapter. (Or install the batteries.)
Refer to section 9.2 "Power" for details.
- Step 3. Install the printer paper
Refer to section 9.3 "Printer Paper Installation" for details.
- Step 4. Press the MODEL key and select the model being connected.

Model number	Model name
1	TM-2430 series
2	UA PC series
3	UB PC series

Refer to section 10.1.1 "Model selection" for details.

- Step 5. Press the TIME/ID key and set the time.
- Step 6. Press the TIME/ID key to set the clock. Since the time and ID can be set at the same time, it is recommended that changes be made to both values simultaneously.
Refer to section 10.2.4 "Time/ID setting" for details.
- Step 7. Press the INTERVAL key and set the automatic measurement interval for the blood pressure monitor.
Refer to section 10.2.5 "Measurement Interval Setting" for details.

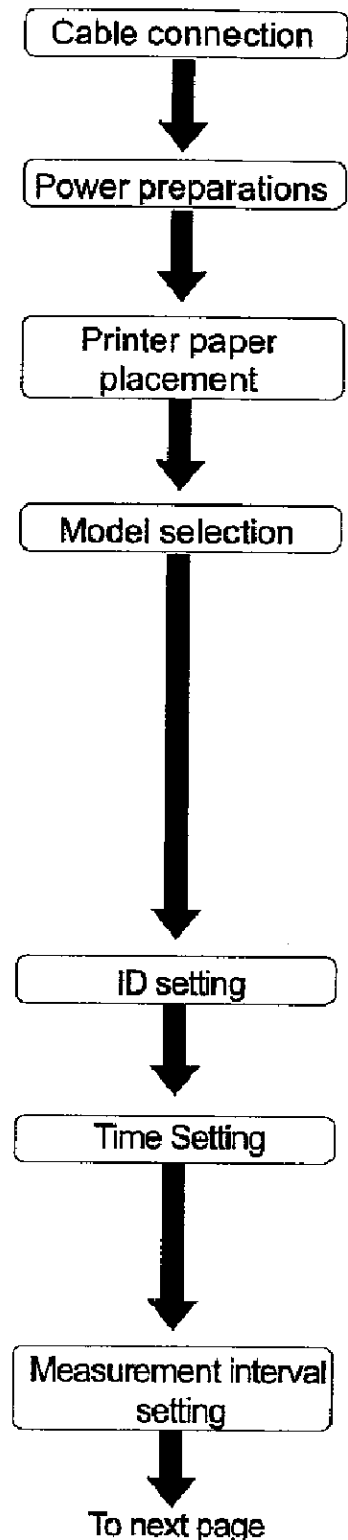

From last page

- Step 8. Press the ENTER key. Printing of the blood pressure monitor and printer terminal setting will begin. Refer to section 10.2.7 " Printing of Setting Content " for details.
- Step 9. Measure the patient's blood pressure. Refer to the operation manual of the blood pressure monitor for details.
- Step 10. Press the UPLOAD/PRINT key. The data will be uploaded and printing will automatically begin. Printing will be done using the previously set report format.
- Step 11. When the uploaded data is to be printed in a different report format, press the PRINT FORMAT key and select the desired format. Refer to section 10.2.3 " Print Format Setting " for details.
- Step 12. The data recorded in memory should be deleted in preparation for the next blood pressure measurement. Press and hold the MEMORY CLEAR key for 5 seconds or more to clear the data. Refer to section 10.2.6 " Memory Clear " for details.

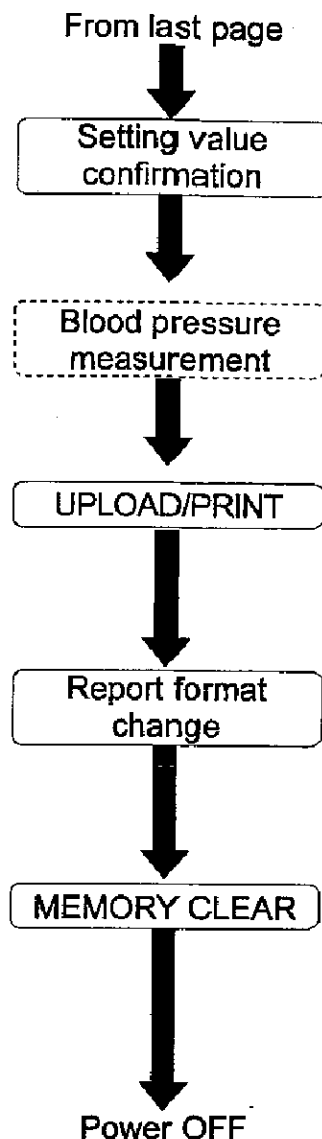

Notice

- Operation or setting that are not required can be skipped.
- When setting do not require changes, data processing is possible using only "Step 10 " and "Step 12 ".

10.1.1. Model Selection

When the overall operation flow is sufficiently understood and printer preparations are complete (items in section 9. "Preparation" are complete), first select the blood pressure monitor model to be connected.

- Step 1. Press the POWER key. When the power is turned on the unit will enter the standby mode.
- Step 2. Press the MODEL key and select the model of the connected blood pressure monitor. The relationship between model numbers and blood pressure monitor model names is shown below.

Model Number

Model number	Model name	Reference section
1	TM-2430 series	10.2 Model 1 operation and setting content
2	UA PC series	10.3 Model 2 operation and setting content
3	UB PC series	10.4 Model 3 operation

Subsequent operation

Once the model number of the connected blood pressure monitor is selected, the following operation will be executed. However, there are some differences depending on the model. Use the reference sections listed in the above table as necessary.

- Step 3. Connect the blood pressure monitor to the printer (except when using infrared communications) to prepare for communication between the units.
- Step 4. Upload measurement data, set the various setting, and select the report format.
- Step 5. When each operation is complete, the unit will return to the standby mode. The operation in step 4 may be repeated at this point if necessary.
- Step 6. When operation is complete, press the POWER key to turn the power off.

An outline of the overall operation flow is shown in the flowchart below.

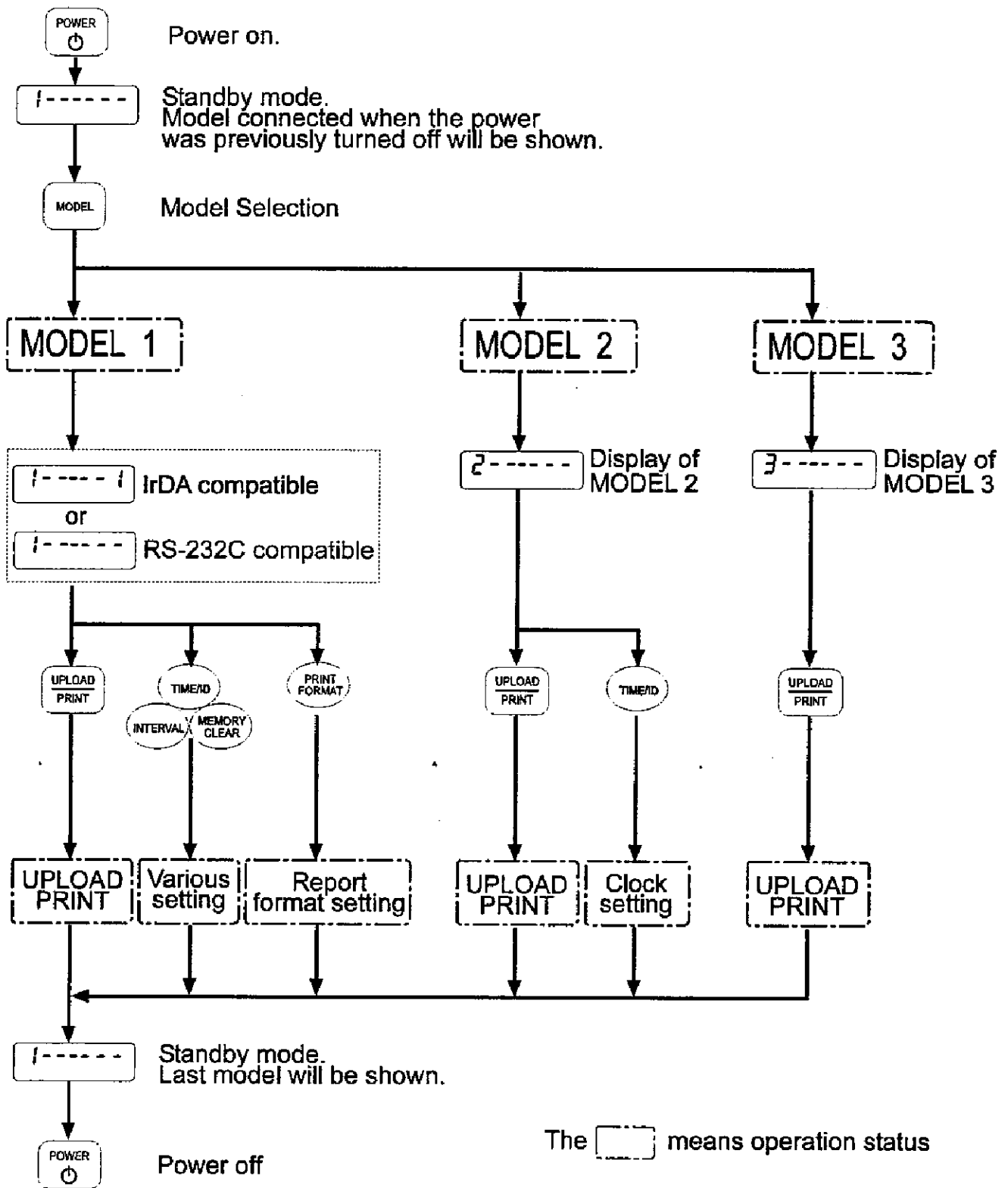

10.2. Model 1, Operation and Setting

When model 1 is selected (10.1.1 "Model selection") , operation is outlined in the following flowchart.

Model name: TM-2430 series

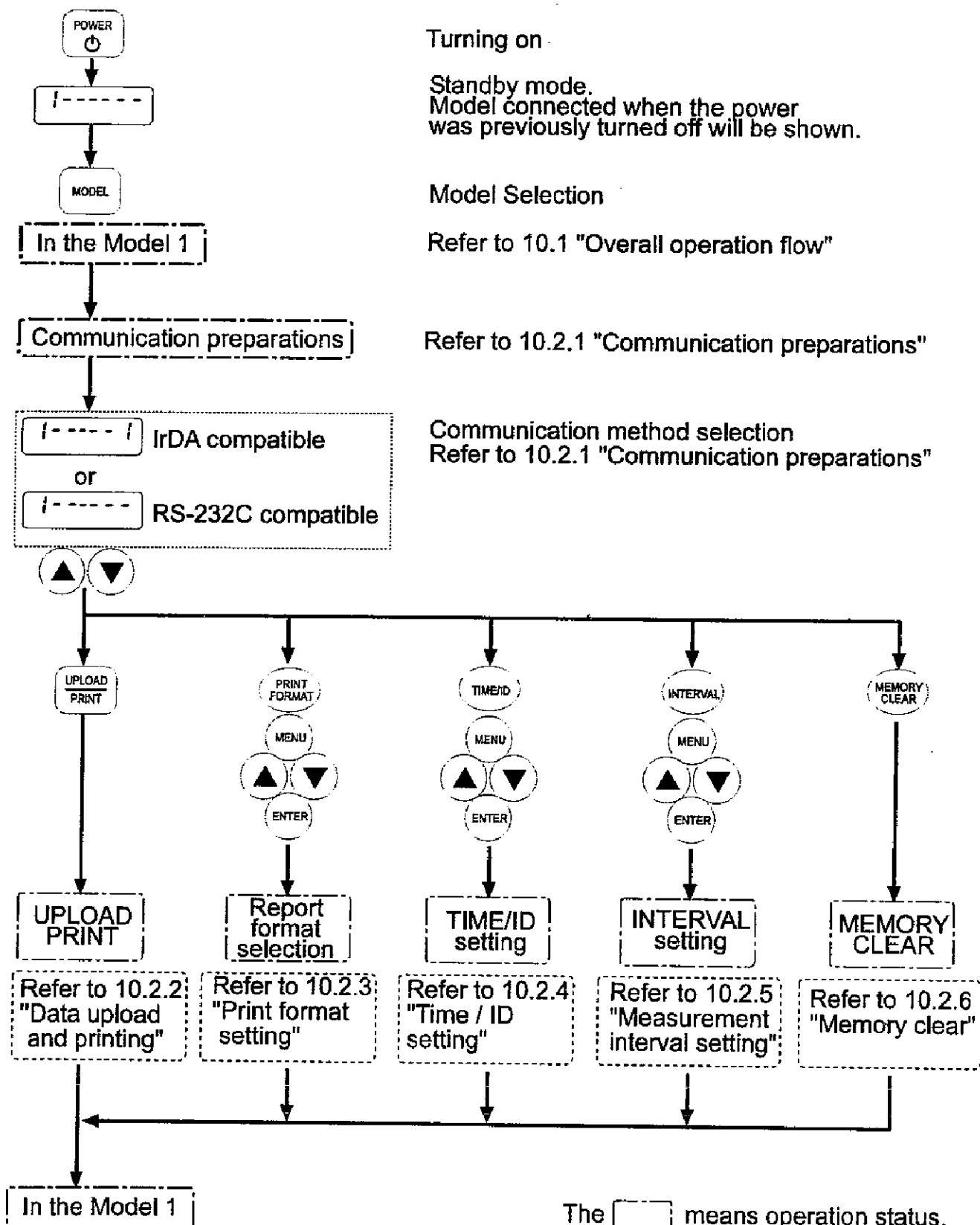

The various relevant setting used when model 1 is selected are shown below. With model 1, all of the printer terminal (TM-2480/2481) functions can be used. For a detailed description of the setting, refer to the reference section listed in the table below. In addition, with model 1 infrared (TM-2481) can be selected as the communication method. Refer to section 10.2.1 "Communication preparations" for details regarding these selections.

Function name	Content	Reference section
UPLOAD/PRINT	Used to upload and print measurement data	10.2.2 "Data upload and printing"
PRINT FORMAT setting	Sets the report format for the measurement data	10.2.3 "Print format setting"
TIME/ID setting	Sets the time and ID number. Display of the blood pressure monitor measurement result can also be turned on or off.	10.2.4 "Time / ID setting"
INTERVAL setting	Sets the interval for automatic measurement by the blood pressure monitor.	10.2.5 "Measurement interval setting"
MEMORY CLEAR	Clears the measurement data in the memory of the blood pressure monitor.	10.2.6 "Memory clear"

1 0.2.1. Communication Preparations

With model 1, cable communication or infrared communication (TM-2481 only) can be selected. A brief description of these communication methods is provided below.

Cable Communication (RS232C communication)

- Step 1. Connect the accessory communication cable to the connector on the back of the printer terminal (refer to section 9. "Preparation").
- Step 2. Press the ▲ ▼ keys to select the communication method.
When the far right digit on the LCD display is a hyphen (-), cable communication is selected.

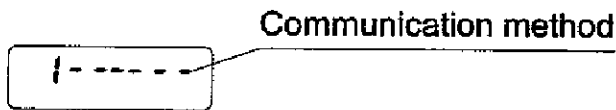

- Step 3. Connect the mini-pin jack end of the accessory communication cable to the blood pressure monitor (TM-2430 series).
The blood pressure monitor (TM-2430 series) display will change to - - - -
- Step 4. When the display changes, preparations for cable communication are complete.

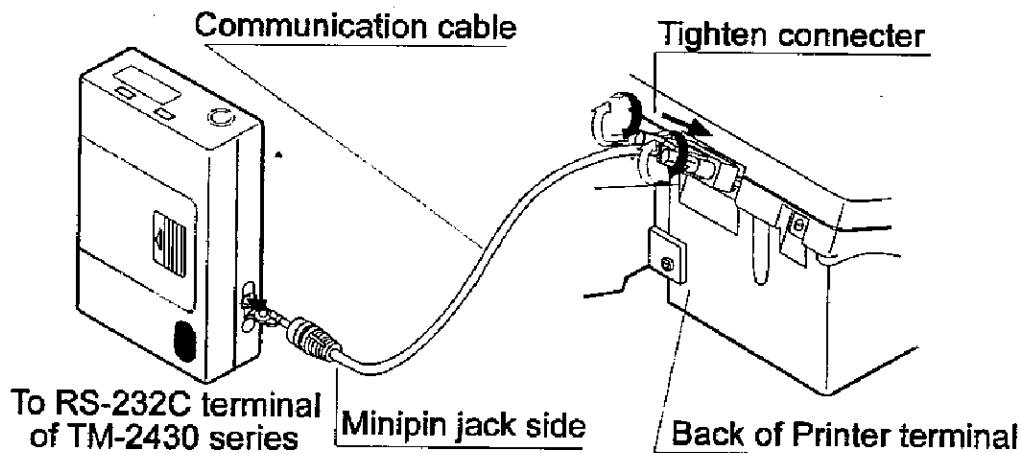

Caution!

When the unit is left with the communication cable inserted in the blood pressure monitor, the batteries will rapidly deteriorate. Therefore, when communications are complete, unplug the cable.

When the cable is unplugged the blood pressure monitor will return to the clock display.

Infrared Communications (IrDA communication) – TM-2481 only

Notice

Infrared communications are limited to use with blood pressure monitors having the infrared communication function (TM-2431).

Step 1. Switch the printer terminal to infrared communications mode.

Press the ▲▼ keys to select the communication method.

When the far right digit on the LCD display is a 1, infrared communication is selected.

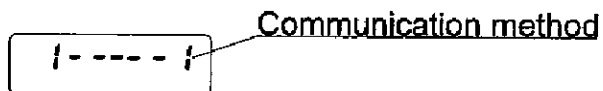

Step 2. Insert the blood pressure monitor (TM-2431) into the back panel pocket of the TM-2481.

Step 3. Changing the blood pressure monitor (TM-2431) to infrared communication mode

Press the AUTO ON/OFF switch on the blood pressure monitor (TM-2431).

Step 4. If the switch is held down the blood pressure monitor display will soon read

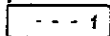

Step 5. When the display changes, preparations for infrared communications are complete.

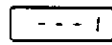

Caution!

When the blood pressure monitor is left in the infrared communications mode ( display), the batteries will rapidly deteriorate. Therefore, when communications are complete, press the AUTO ON/OFF switch to exit the infrared communication mode.

When the infrared communications mode is exited the blood pressure monitor will return to the clock display.

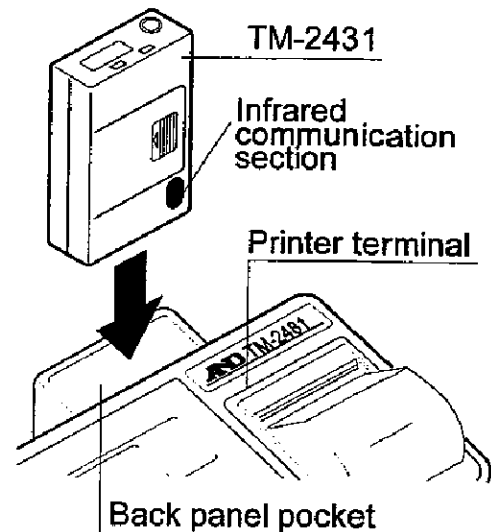

10.2.2. Data Upload and Printing

Explanation

With model 1, the print format can be selected. The various print formats are described in the table below.

Print format	Content
1	Prints a table + blood pressure graph + pulse graph + pressure load graph (refer to section 13. Appendix (TM-2430 series printout example)).
2	Prints a table + blood pressure graph + pulse graph.
3	Prints a table + pressure load graph.
4	Prints a table only.
5	Prints the blood pressure graph only.
6	Prints the pulse graph only.
7	Prints the pressure load graph only.

- The method for setting the report format, including the print formats for model 1, is described in section 10.2.3 "Print format setting."
- When the UPLOAD/PRINT key is pressed, measurement data from the blood pressure monitor is uploaded. The measurement results are then printed according to the selected report format.
- The report format is saved even when the power is turned off.
- When measurement data is uploaded, the **[BPM]** indicator is displayed. While this mark is displayed the printer will maintain the measurement data in memory. If the report format is changed while the measurement data is recorded in memory, printing will begin using the new report format.
- Uploaded measurement data will be deleted when the connected model is changed or the power is turned off.

Setting Procedure

- Step 1. Confirm that communication preparations are complete (refer to section 10.2.1 "Communication preparations").
- Step 2. Press the **UPLOAD/PRINT** key. Measurement data will be uploaded from the blood pressure monitor.
- Step 3. The **BPM** indicator is displayed when uploading is complete.
- Step 4. Printing will begin. The **PRINT** mark will blink during printing.
- Step 5. The **PRINT** indicator will go out when printing is complete.

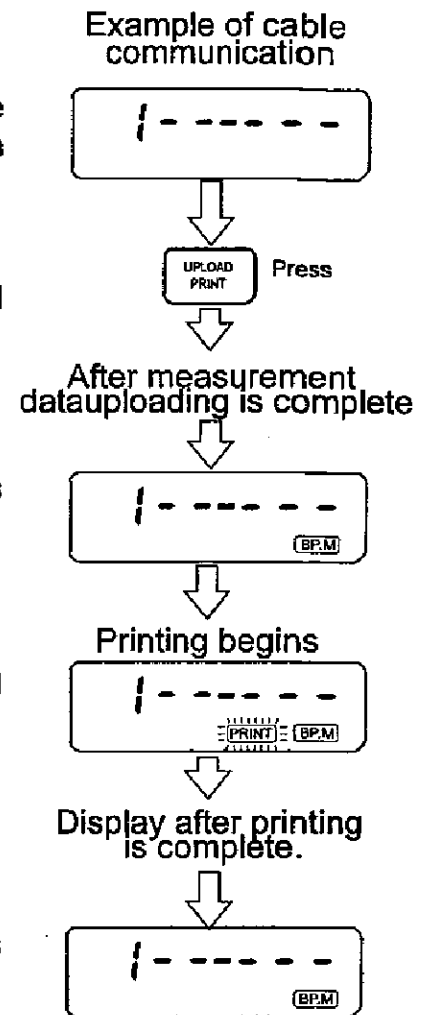

10.2.3. Print Format Setting

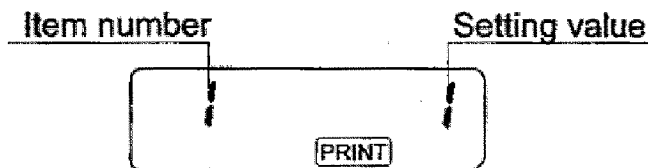

Explanation

- The report format setting is used to input various parameters into the printer terminal. This setting does not change the measurement data, time, or other setting of the blood pressure monitor.
- The above display appears when the PRINT FORMAT key is pressed.
- The **PRINT** indicator displayed during report format setting.
- When measurement data is in memory (**B.P.M** indicator is displayed), printing in the new format will begin after changes are made.
- The report format is saved in memory even when the power is turned off.
- An explanation of item numbers and setting values is provided in the table below.

Item number	Setting value range	Setting content
1	1 ~ 7	Print format 1 Table + blood pressure graph + pulse graph + pressure load graph 2 Table + blood pressure graph + pulse graph 3 Table + pressure load graph 4 Table 5 Blood pressure graph 6 Pulse graph 7 Pressurê load graph
2	AU, 0 ~ 23	Processing start time AU Time of first measurement data (automatic) 0 ~ 23 Set time
3	0 ~ 23	Sleep time
4	0 ~ 23	Awake time
5	100 ~ 180	Systolic threshold value while awake (set in 5mmHg steps)
6	50 ~ 130	Diastolic threshold value while awake (set in 5mmHg steps)
7	100 ~ 180	Systolic threshold value while a sleep (set in 5mmHg steps)
8	50 ~ 130	Diastolic threshold value while a sleep (set in 5mmHg steps)
9	—	Initial setting Print format: 1 Processing start time: AU Sleep time: 22 (10:00pm) Awake time: 7 (7:00am) Systolic threshold value while awake: 140mmHg Diastolic threshold value while awake: 90mmHg Systolic threshold value while a sleep: 140mmHg Diastolic threshold value while a sleep: 90mmHg

Setting Procedure

- Step 1.** When communication preparations are complete (refer to section 10.2.1 "Communication preparations"), press the PRINT FORMAT key.
- Step 2.** The **PRINT** indicator is displayed and item number 1 will be displayed along with the current setting value.
- Step 3.** To change the setting value, press the **▲ ▼** keys. In this example the setting value in item number 1 (print format) will be changed to 3 (table + pressure load graph).
- Step 4.** When changing the item number, press the **MENU** key. When changing the setting value, press the **▲ ▼** keys. In this example the setting value of item number 2 (processing start time) will be changed to 3 (3:00AM).
- Step 5.** When changes are necessary, repeat the same basic operations to change the setting values for each item number.
- Step 6.** When changes are complete press the **ENTER** key to confirm the new values. When measurement data is contained in memory (**B.P.M** indicator displayed), printing will begin using the new setting. When measurement data is not contained in memory, "PLEASE UPLOAD DATA" will be printed and the report format will be set.
- Step 7.** If the **CANCEL** key is pressed without pressing the **ENTER** key, report format setting will be canceled and the report format will not be changed.

Example using cable communications

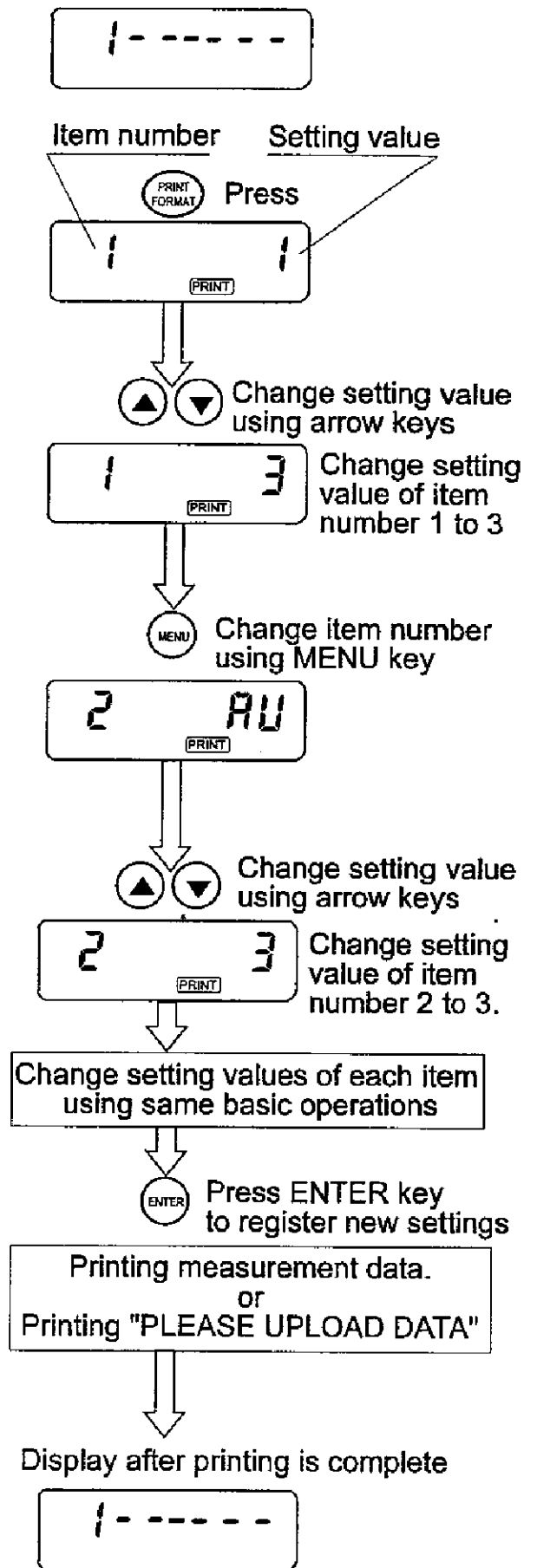

10.2.4. Time/ID Setting



Explanation

- The time/ID setting sets the various parameters in the blood pressure monitor (TM-2430 series).
- The display shown above appears when the TIME/ID key is pressed.
- The **TIME** indicator is displayed during time/ID setting operation.
- An explanation of item numbers and setting values is shown in the table below.

Item number	Setting value range	Setting content
1	0,1	Display function on/off 0: Off , 1: On
2	1 ~ 99	ID number
5	1997 ~ 2096	Year (4 digits)
6	1 ~ 12	Month
7	1 ~ 31	Day (setting range is automatically adjusted according to the year and month)
8	0 ~ 23	Hour (use 24-hour time)
9	00 ~ 59	Minutes (2 digits are always displayed)

Use the display function on/off item only after reading the operation manual of the blood pressure monitor.

Setting Procedure

- Step 1.** When communication preparations are complete (refer to section 10.2.1 "Communication preparations"), press the TIME/ID key.
- Step 2.** The TIME indicator and item number 1 will be displayed along with the setting value for the connected blood pressure monitor.
- Step 3.** To change the setting value, press the ▲ ▼ keys.
In this example the setting value in item number 1 (display function on/off) will be changed to 1 (on).
- Step 4.** When changing the item number, press the MENU key. When changing the setting value, press the ▲ ▼ keys.
In this example the setting value of item number 2 (ID number) will be changed to 90.
- Step 5.** When other changes are necessary, select each item number and repeat the same basic operations to change the setting values for year, month, day, hour, and minute.
- Step 6.** When changes are complete press the ENTER key to confirm the new values.
The new setting for the blood pressure monitor will be printed. Please check the content of the setting.
- Step 7.** If the CANCEL key is pressed without pressing the ENTER key, time/ID setting operation will be canceled and the setting of the blood pressure monitor will not be changed.

Example using cable communications

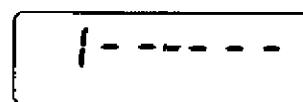

Item number Setting value

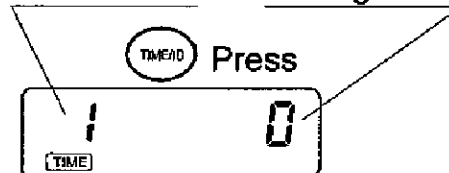

Change setting value using arrow keys



Change setting value of item number 1 to 1



Change item number using MENU key

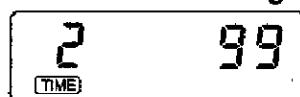

Change setting value using arrow keys



Change setting value of item number 2 to 90

Set these parameters of year, month, day, hour, and minute using same basic operations



Press ENTER key to register new settings

Setting content will be printed

Display after printing is complete

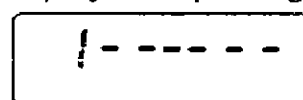

10.2.5. Measurement Interval Setting

Item number



Explanation

- The measurement interval setting sets the measurement interval to be used for automatic measurement by the blood pressure monitor (TM-2430 series).
- The above display appears when the INTERVAL key is pressed.
- The **COND** indicator is displayed during measurement interval setting.
- An explanation of the item numbers is provided in the table below.

Item number	Setting content
1	Automatic measurement mode I 07:00 ~ 21:59: 15-minute intervals 22:00 ~ 6:59: 30-minute intervals
2	Automatic measurement mode II 15-minute intervals when S is not displayed 30-minute intervals when S is displayed
3	Automatic measurement mode III Maximum of 6 blocks can be set Enter other setting routine

For details regarding the measurement interval refer to the operation manual of the blood pressure monitor (TM-2430 series).

Setting Procedure

- Step 1. When communication preparations are complete (refer to section 10.2.1 "Communication preparations"), press the INTERVAL key.
- Step 2. The **COND** indicator is displayed and the item number set in the connected blood pressure monitor will be displayed.
- Step 3. To change the item number, press the MENU key.
In this example the item number 1 (automatic measurement mode I) will be changed to 2 (automatic measurement mode II).
- Step 4. When changes are complete press, the ENTER key to confirm the new value.
(When item number 3 is selected, setting operation will continue. Refer to the next section for automatic measurement mode III setting.)
The new setting for the blood pressure monitor will be printed. Please check the content of the setting.
- Step 5. If the CANCEL key is pressed without pressing the ENTER key, the measurement interval setting operation will be canceled and the setting of the blood pressure monitor will not be changed.

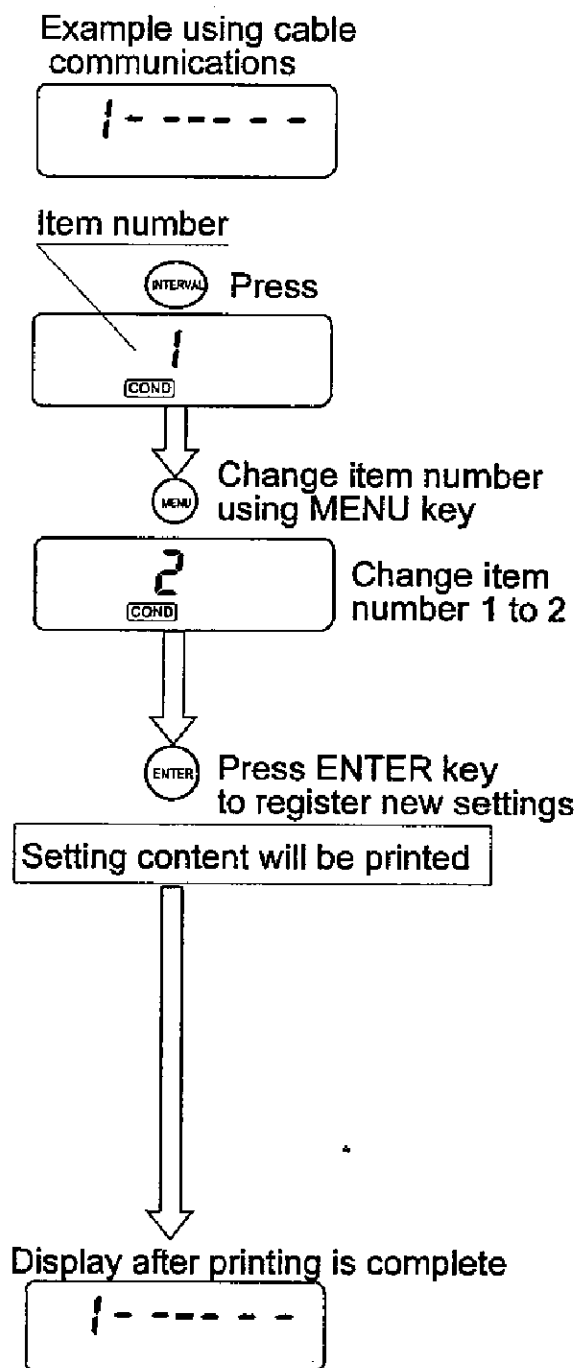

10.2.5.1. Setting of Automatic Measurement Mode III

This is automatic measurement mode III (item number 3) setting.

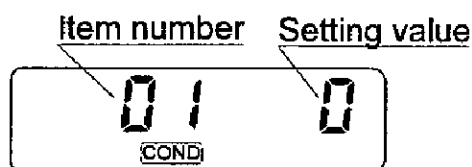

Explanation

- When automatic measurement mode III is selected as the measurement interval, the 24-hour time period in a day can be divided into up to 6 blocks and the measurement interval can be set for each block.
- The **COND** indicator will continue to be displayed and the above display will appear.
- An explanation of each item number is provided in the table below.

Item number	Setting range	Setting content
01	0 ~ 23	Block 1 start time
02	(Note 1)	Measurement interval
03	0 ~ 23	Block 1 end time (block 2 start time).
04	(Note 1)	Measurement interval
05	0 ~ 23	Block 2 end time (block 3 start time). However, a value within the previous block time cannot be set.
06	(Note 1)	Measurement interval
07	0 ~ 23	Block 3 end time (block 4 start time). However, a value within the previous block time cannot be set.
08	(Note 1)	Measurement interval
09	0 ~ 23	Block 4 end time (block 5 start time). However, a value within the previous block time cannot be set.
10	(Note 1)	Measurement interval
11	0 ~ 23	Block 5 end time (block 6 start time). However, a value within the previous block time cannot be set.
12	(Note 1)	Measurement interval
13	Block 1 start time	Block 6 end time However, the block 1 start time must be input.

Note 1: The selective range is OFF, 5, 10, 15, 20, 30, 60, and 120 in units of minute.

Setting Procedure

Step 1. Enter the mode 1 using the MODEL key from the standby mode. (Refer to section 10.2.1).

Step 2. Select item 3 as the measurement interval and press the ENTER key. Setting for automatic measurement mode III will then be possible. The setting method for block 1 start time, measurement interval, and end time will be used as an example for this explanation. The setting method for subsequent blocks is the same.

Step 3. Item number 01 (block 1 start time) will be displayed. When changing the start time setting value, press the ▲ ▼ keys. In this example the setting value of item number 01 (block 1 start time) is changed to 1 (start time of 1:00AM).

Step 4. Press the MENU key to display item number 02 (block 1 measurement interval). When changing the measurement interval setting value, press the ▲ ▼ keys. In this example the setting value of item number 02 (block 1 measurement interval) is changed to 30 (30 minutes).

Step 5. Press the MENU key to display item number 03 (block 1 end time). When changing the end time setting, press the ▲ ▼ keys. The block 1 end time automatically becomes the block 2 start time. In this example the setting value of item number 03 (block 1 end time) is changed to 22 (10:00PM).

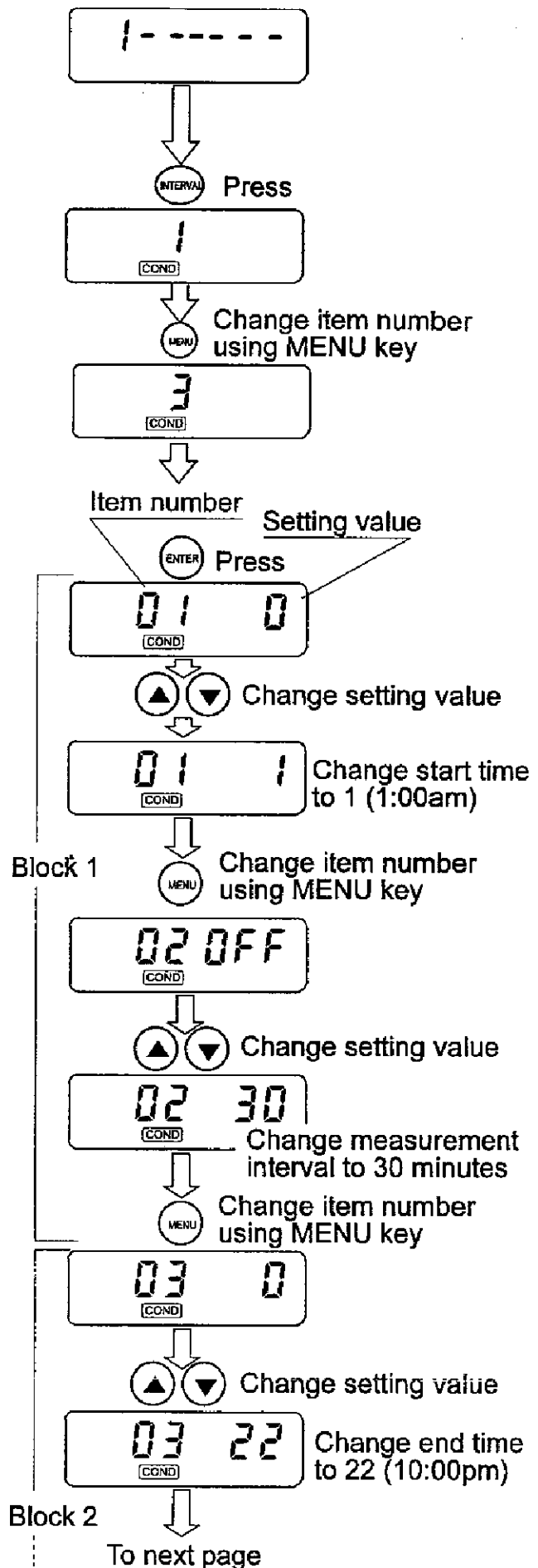

Step 6. When setting for block 2 and subsequent blocks are necessary, use the same procedure to select item numbers and change setting values. However, be sure to carefully read and understand the setting cautions described in the next section.

Step 7. When changes are complete, press the ENTER key to register the new values and exit the setting mode. The new setting for the blood pressure monitor will be printed. Please check the content of these setting.

Step 8. If the CANCEL key is pressed without pressing the ENTER key, the measurement interval setting operation will be canceled and the setting of the blood pressure monitor will not be changed.

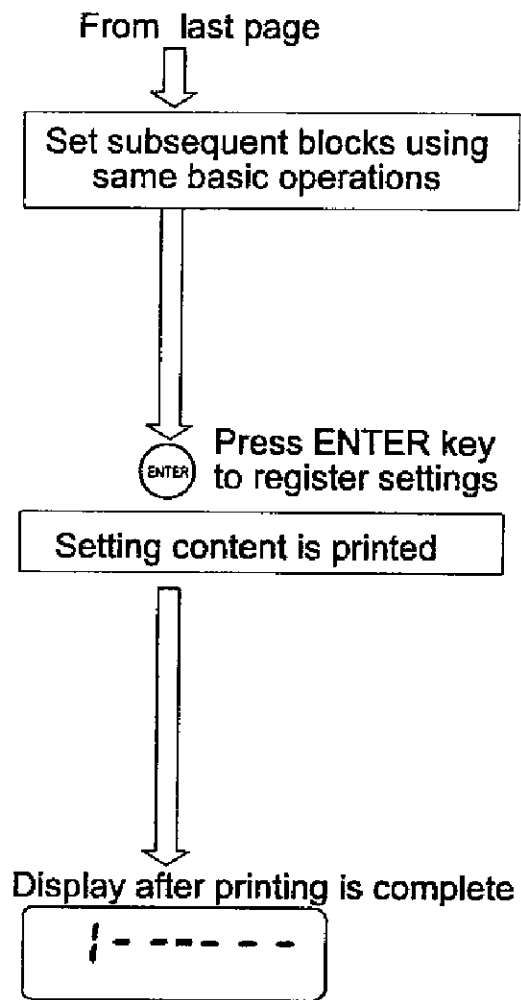

Setting Cautions

- The time range set in a previous block cannot be set in the next block.

Example

Block 1: 1 ~ 5 (1:00AM ~ 5:00AM)
 Block 2: 5 ~ 14 (5:00PM ~ 2:00PM)

In this case the setting value for block 3 end time (item number 07) must be within the 14 ~ 23, 0 ~ 1 range.

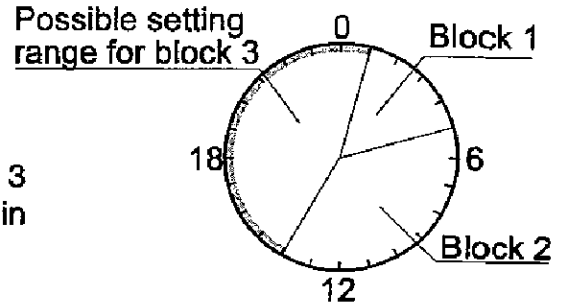

Item number	Setting range	Setting content
01	1	Block 1 start time
02	—	Measurement interval
03	5	Block 1 end time (block 2 start time)
04	—	Measurement interval
05	14	Block 2 end time (block 3 start time)
06	—	Measurement interval
07	14 ~ 23 0 ~ 1	Block 3 end time (block 4 start time). However, the time range used in previous blocks cannot be set.

- Even when a total of 6 blocks are not used, further block setting is not possible once a total of 24 hours has been used by all currently set blocks.

Example

Block 1: 1 ~ 5 (1:00AM ~ 5:00AM)
 Block 2: 5 ~ 14 (5:00AM ~ 2:00PM)
 Block 3: 14 ~ 1 (2:00PM ~ 1:00AM)

In this case the block 4 measurement interval setting (item number 08) will not appear when the menu key is pressed. Instead, item number 01 will appear.

Since there is no remaining time, block 4 cannot be set.

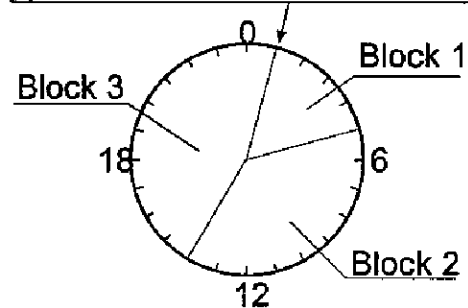

- When 120 minutes is selected as the measurement interval, the display will require an end time using 2-hour intervals.

Example

Block 1 start time: 1 (1:00AM)

Block 1 measurement interval: 120 minutes

In this case the setting values displayed for block 1 end time (item number 03) will be 1, 3, 5, 7, 9, 11, 13, 15, 17, 19, 21, and 23.

- The 120 minute measurement interval will not be displayed for final blocks containing only 1 hour of time.

A final block is defined as the next block when the total time set for previous blocks is 23 hours.

Example

Block 1 start time: 0 (12:00AM)

Block 1 measurement interval (60 minutes)

Block 1 end time 23 (11:00PM)

In this case, a setting value of 120 cannot be input for the measurement interval of block 2 (item number 04).

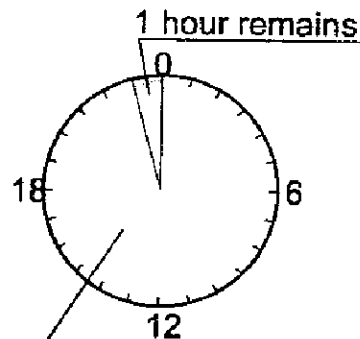

Block 1
The situation is the same when multiple blocks use this period of time.

10.2.6. Memory Clear

Explanation

The MEMORY CLEAR key is used to delete the measurement data in the blood pressure monitor (TM-2430 series).

Setting Procedure

- Step 1. When communication preparations are complete (refer to section 10.2.1 "Communication preparations"), press and hold the MEMORY CLEAR key. The buzzer will beep every second and, after 5 seconds, a long buzzer sound will be heard.

After measurement data has been cleared, the message "MEMORY CLEARED" will be printed.

When measurement data has not been cleared, the message "MEMORY CLEAR FAILED" will be printed.

- Step 2. When the MEMORY CLEAR key is not pressed and held for 5 seconds the measurement data will not be deleted. In this case no message will be printed

Caution!

Be careful when using these operations since measurement data cleared from the blood pressure monitor cannot be recovered. Be sure to execute measurement data processing before clearing the memory.

When attaching the blood pressure monitor to a new person, be sure to clear the measurement data.

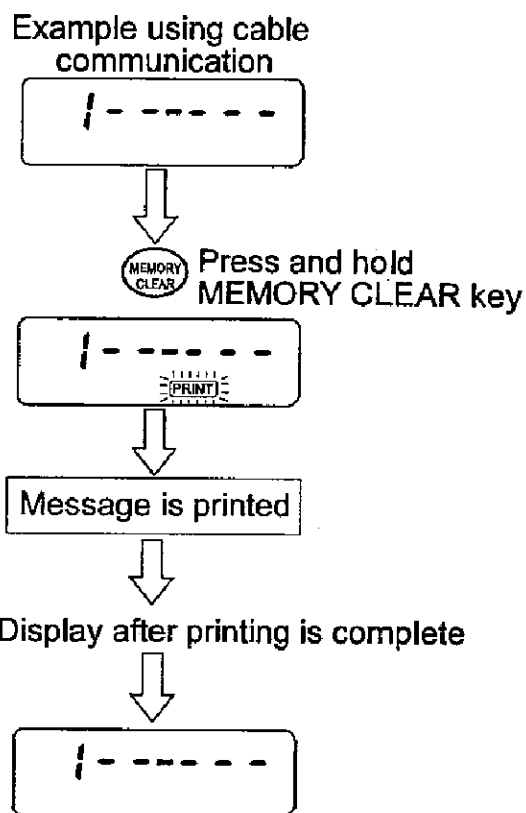

10.2.7. Printing of Setting Content

Explanation

- The time, measurement interval, ID, and other items set in the blood pressure monitor (TM-2430 series) will be printed.
- The report format set in the printer terminal (TM-2480) will also be printed.

Setting Procedure

Step 1. When communication preparations are complete (refer to section 10.2.1 "Communication preparations"), press the ENTER key. Printing will begin.

Notice

When no blood pressure monitor is connected, only the report format will be printed.

Example using cable communication

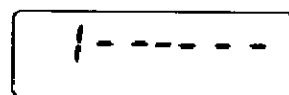

ENTER Press

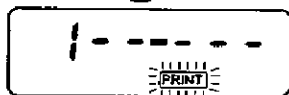

Time, measurement interval, ID, and other items are printed Report format is printed



Display after printing is complete.

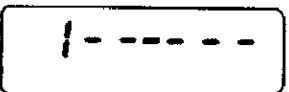

10.3. Model 2, Operation and Setting

When model 2 is selected in the overall operation flow (10.1.1 Model selection) shown in section 10.1, the subsequent operations are outlined in the following flowchart.

Model name: UA PC series

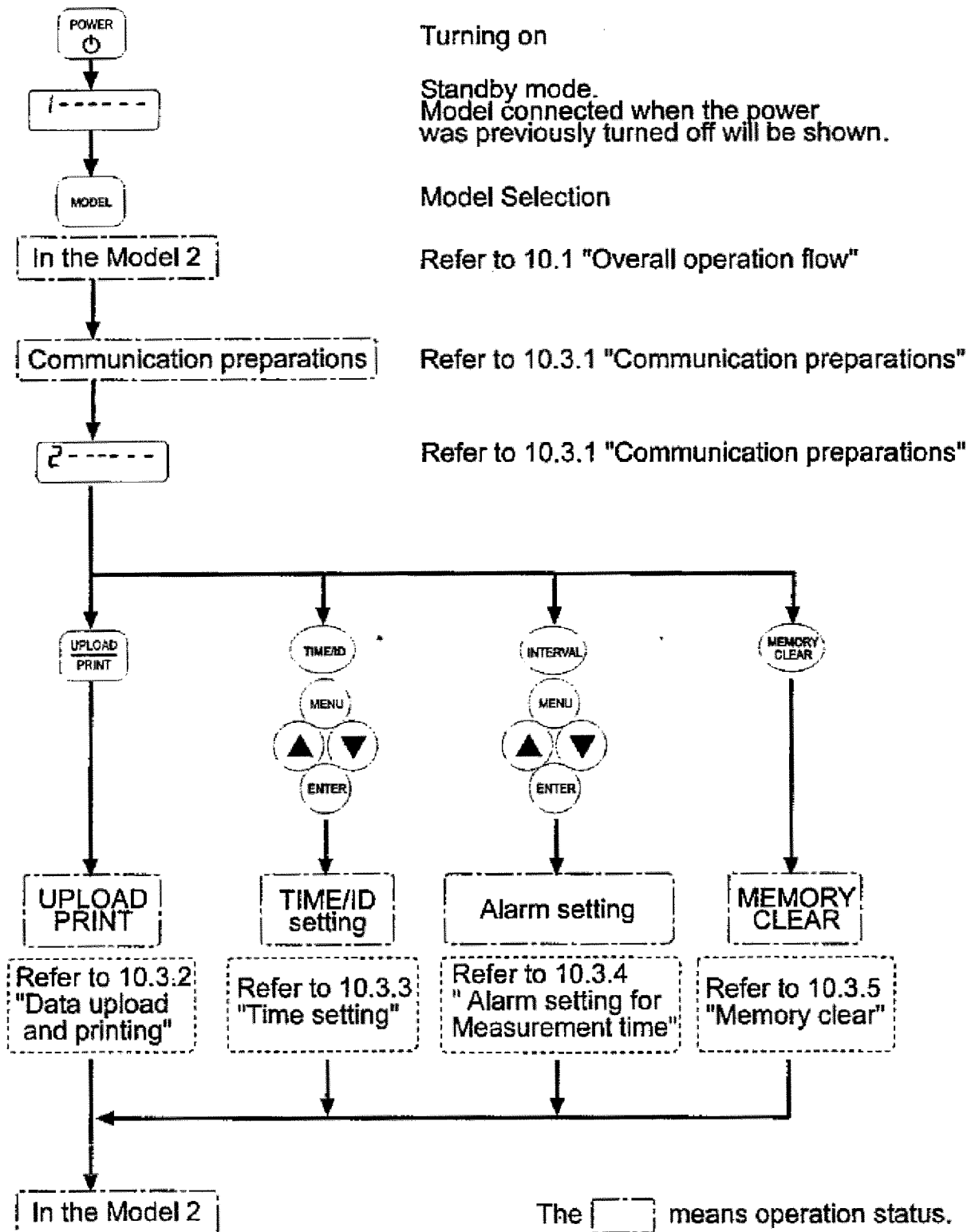

When model 2 is selected the functions that can be used with the printer terminal (TM-2480) are limited. The functions and various setting that can be used are shown in the table below. For a detailed description of the setting, refer to the reference section listed in the table below.

Function name	Content	Reference section
UPLOAD/PRINT	Used to upload and print measurement data	10.3.2 "Data Upload and Printing"
Time Setting	Sets the time	10.3.3 "Time Setting"
Alarm Setting	Sets the alarm for measurement of the blood pressure monitor	10.3.4 " Alarm Setting for Measurement Time"
Memory Clear	Clears the measurement data in the blood pressure monitor	10.3.5 "Memory Clear"

10.3.1. Communication Preparations

- Step 1. Connect the accessory communication cable to the connector on the back of the printer terminal (refer to section 9. "Preparation").
- Step 2. When the blood pressure monitor displays clock, connect the mini-pin jack of the accessory communication cable to the blood pressure monitor.

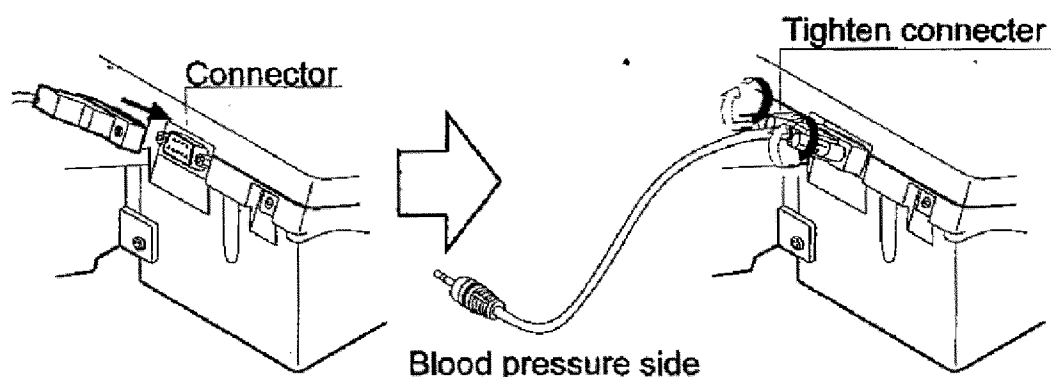

⚠ Caution!

When the unit is left with the communication cable inserted in the blood pressure monitor, the batteries will rapidly deteriorate. Therefore, when communications are complete, remove the cable. When the cable is removed, the blood pressure monitor will return to the clock display.

About several products, this connection procedure is different. Refer to the instruction manual of product you use

10.3.2. Data Upload and Printing

Explanation

- When the UPLOAD PRINT key is pressed, measurement data is uploaded from the blood pressure monitor. Measurement results are then printed using the standard report format.
With model 2, the report format cannot be selected.
- When measurement data is uploaded, the **BP.M** indicator is displayed. Measurement data uploading is complete when this indicator is displayed. The communication cable can be unplugged from the blood pressure monitor at this time.

Setting Procedure

- Step 1. Confirm that communication preparations are complete (refer to section 10.3.1 "Communication preparations").
- Step 2. Press the UPLOAD/PRINT key. Measurement data will be uploaded from the blood pressure monitor.
- Step 3. The **BP.M** indicator is displayed when uploading is complete.
- Step 4. Printing will begin. The **PRINT** indicator will blink during printing.
- Step 5. The **PRINT** indicator will go out when printing is complete.

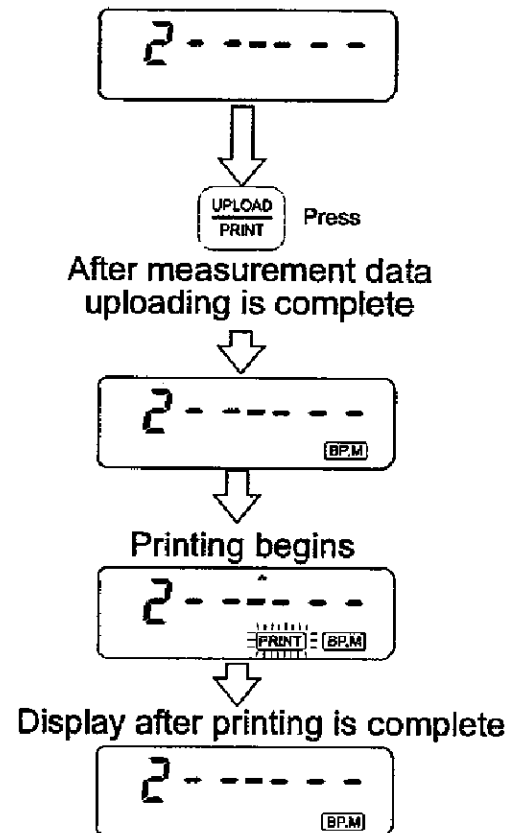

10.3.3. Time Setting

Item number Setting value

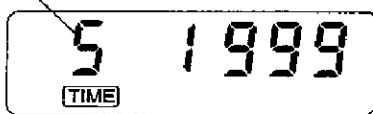

Explanation

- This setting sets the time in the blood pressure monitor (UA PC series).
- The display shown above appears when the TIME/ID key is pressed.
- The TIME indicator is displayed during time setting operation.
- An explanation of item numbers and setting values is shown in the table below.

Item number	Setting value range	Setting content
5	1997 ~ 2096	Year (4 digits)
6	1 ~ 12	Month
7	1 ~ 31	Day (setting range is automatically adjusted according to the year and month)
8	0 ~ 23	Hour (use 24-hour time)
9	00 ~ 59	Minutes (2 digits are always displayed)

Setting Procedure

- Step 1. When communication preparations are complete (refer to section 10.3.1 "Communication preparations"), press the TIME/ID key.
- Step 2. The **TIME** indicator and item number 5 will be displayed along with the setting value for the connected blood pressure monitor.
- Step 3. To change the setting value, press the **▲ ▼** keys. In this example, the setting value in item number 5 (year) will be changed to 1999.
- Step 4. When changing the item number, press the **MENU** key. When changing the setting value, press the **▲ ▼** keys. In this example, the setting value of item number 6 (month) will be changed to 4 (April).
- Step 5. When other changes (day, hour, minute) are necessary, select each item number and repeat the same basic procedure to change the setting.
- Step 6. When changes are complete press the **ENTER** key to confirm the new values. The new setting for the blood pressure monitor will be printed. Please check the content of the setting.
- Step 7. If the **CANCEL** key is pressed without pressing the **ENTER** key, the time setting operation will be canceled and the setting of the blood pressure monitor will not be changed.

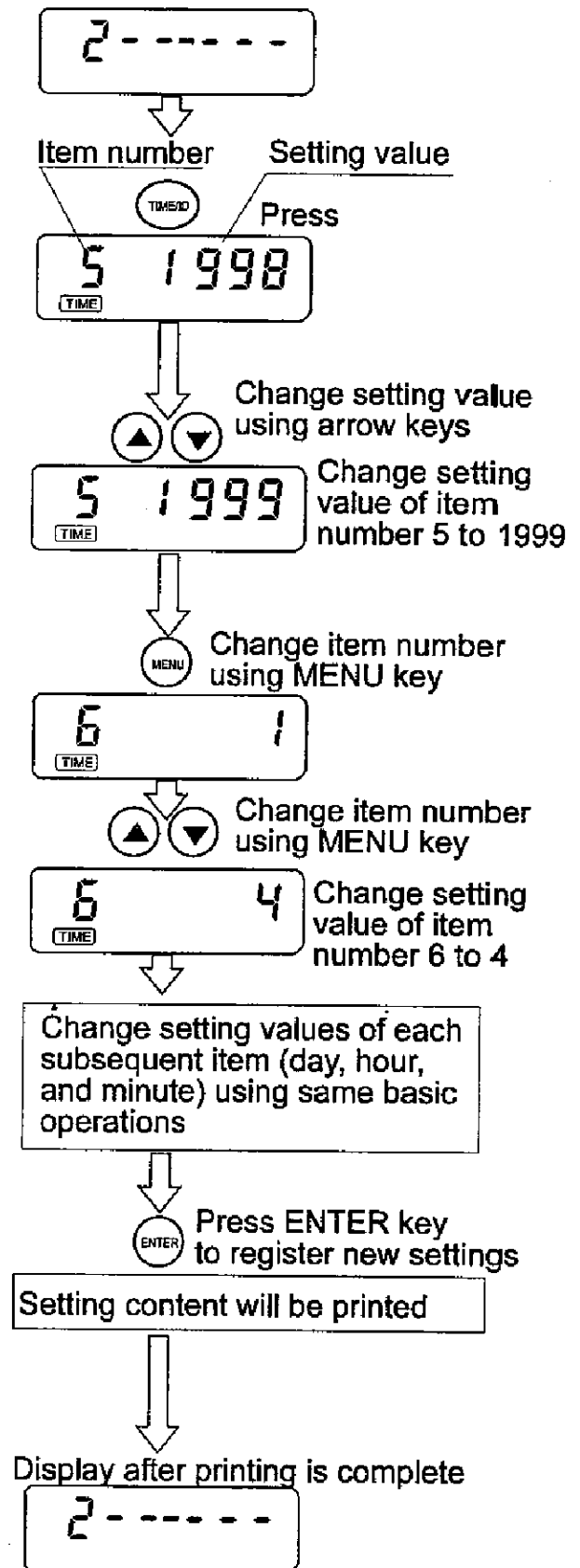

10.3.4. Alarm Setting for Measurement Time

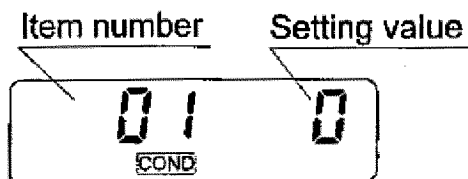

Explanation

- This function uses for the alarm at the measurement time. And it can set alarms up to six times.
- The above display appears when the INTERVAL key is pressed.
- The **COND** indicator is displayed during the operation.
- An explanation of the item numbers is provided in the table below.

Item number	Setting range	Setting content	
01	OFF, 0 ~ 23	First measurement time	(hour)
02	0 ~ 59	First measurement time	(minute)
03	OFF, 0 ~ 23	Second measurement time	(hour)
04	0 ~ 59	Second measurement time	(minute)
05	OFF, 0 ~ 23	Third measurement time	(hour)
06	0 ~ 59	Third measurement time	(minute)
07	OFF, 0 ~ 23	Fourth measurement time	(hour)
08	0 ~ 59	Fourth measurement time	(minute)
09	OFF, 0 ~ 23	Fifth measurement time	(hour)
10	0 ~ 59	Fifth measurement time	(minute)
11	OFF, 0 ~ 23	Sixth measurement time	(hour)
12	0 ~ 59	Sixth measurement time	(minute)

Refer to the operation manual of the blood pressure monitor (UA PC series) for details regarding this alarm function.

Setting Procedure

Step 1. When communication preparations are complete (refer to section 10.3.1 "Communication preparations"), press the INTERVAL key.

Step 2. The [COND] indicator will light and the time for the first alarm, set in the connected blood pressure monitor, will be displayed.

Step 3. To change the setting value, press the ▲ ▼ keys. In this example the time for item number 1 (first alarm time (hour)) will be set to 10 (10:00AM).

Step 4. Press the MENU key to change item numbers and press the ▲ ▼ keys to change setting values. In this example, the setting value in item number 2 (first alarm time (minutes)) will be set to 30 (30 minutes).

Step 5. When changes in the second alarm and subsequent alarm are required, use the same procedure to select item numbers and set the hour and minute.

Step 6. Press the ENTER key to register changes and exit the setting mode. The new setting for the blood pressure monitor will be printed. Please check the content of the setting.

Step 7. If the CANCEL key is pressed without pressing the ENTER key, the current setting will be canceled. Then the blood pressure monitor will not be changed.

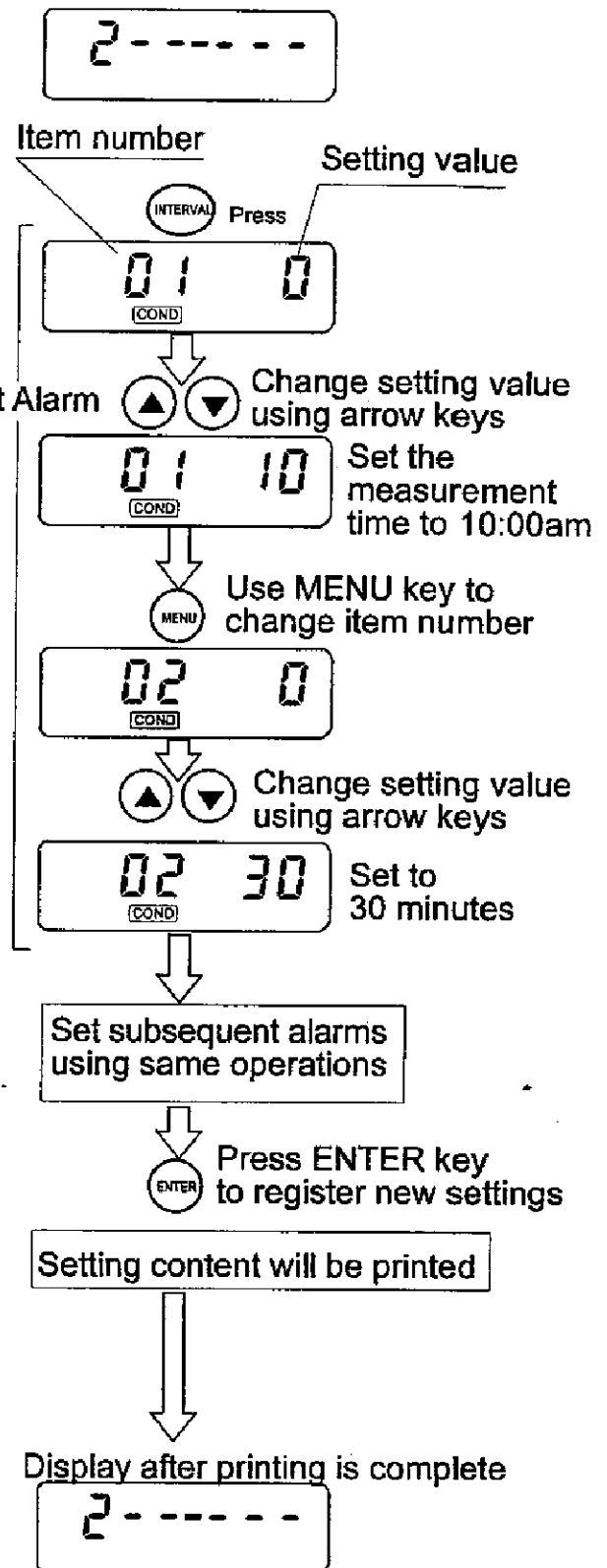

10.3.5. Memory Clear

Explanation

The MEMORY CLEAR key is used to delete measurement data in the blood pressure monitor (UA PC series).

Setting Procedure

- Step 1. When communication preparations are complete (refer to section 10.3.1 "Communication preparations"), press and hold the MEMORY CLEAR key. The buzzer will beep every second, and after 5 seconds a long buzzer sound will be heard. After measurement data has been cleared, the message "MEMORY CLEARED" will be printed. When measurement data has not been cleared, the message "MEMORY CLEAR FAILED" will be printed.
- Step 2. When the MEMORY CLEAR key is not pressed and held for 5 seconds, the measurement data will not be deleted. In this case no message will be printed.

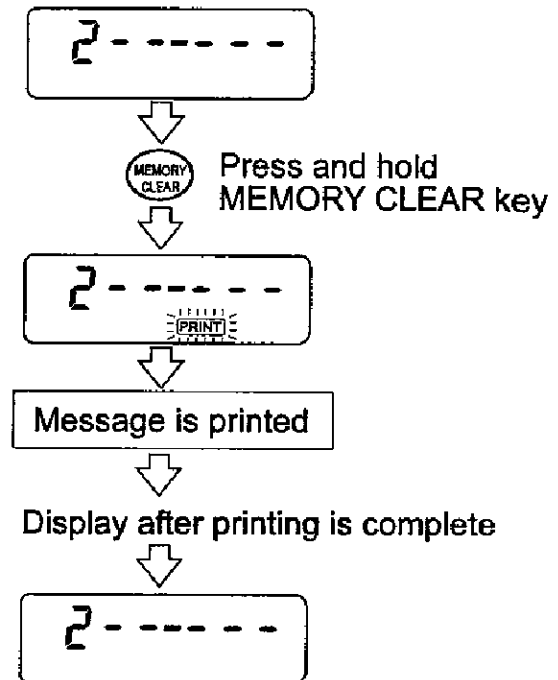

⚠ Caution!

Be careful when using these operations since measurement data cleared from the blood pressure monitor cannot be recovered. Be sure to execute measurement data processing before clearing the memory.

10.3.6. Printing of Setting List

Explanation

The alarm time set in the blood pressure monitor (UA PC series) will be printed.

Procedure

- Step 1. When communication preparations are complete (refer to section 10.3.1 "Communication preparations"), press the ENTER key. Printing will begin.

Notice

When no blood pressure monitor is connected, no printing will be done.

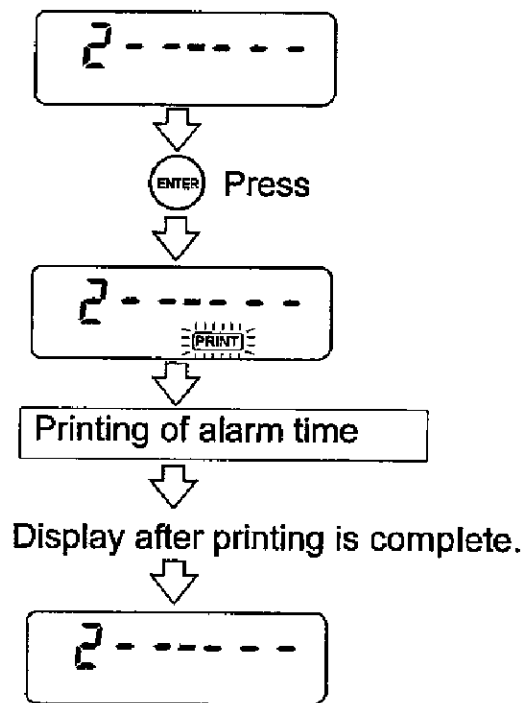

10.4. Model 3, Operation and Setting

When model 3 is selected (10.1.1 "Model selection"), operations are outlined in the following flowchart.

Model name: UB PC series

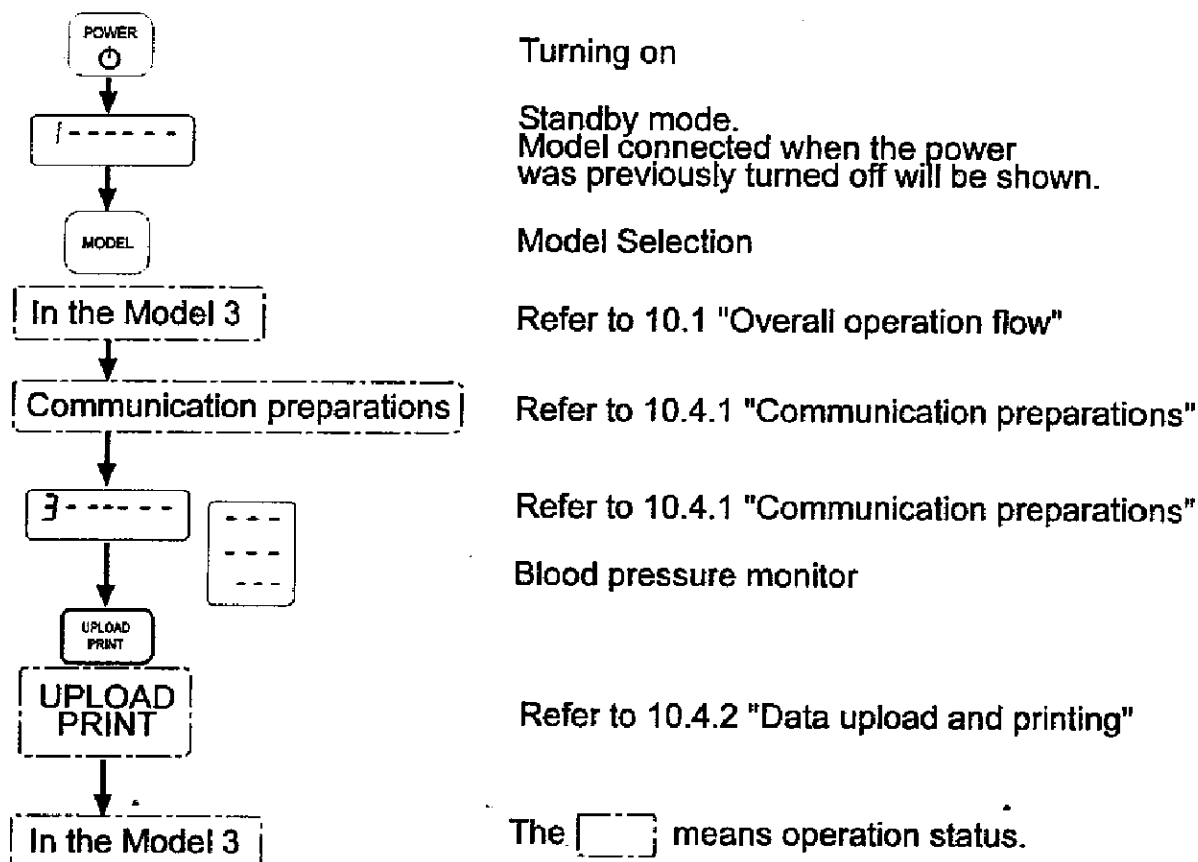

When model 3 is selected the functions that can be used with the printer terminal are limited. The functions and various setting that can be used are shown in the table below. For a detailed description of the setting methods, refer to the reference section listed in the table below.

Function name	Content	Reference section
UPLOAD/PRINT	Upload and print measurement data	10.4.2 "Data Upload Printing"

Only one-way communication functions can be used with model 3. The blood pressure monitor time setting and measurement data clearing operation are done on the blood pressure monitor side. Use the printer after reading the operation manual of the blood pressure monitor (UB PC series).

A special communications adapter, sold separately, is required with model 3.

⚠ Caution!

When the unit is left with the communication cable inserted in the blood pressure monitor, the batteries will rapidly drain. Therefore, when communications are complete, unplug the cable. When the cable is unplugged the blood pressure monitor will return to the clock display.

10.4.1. Communication Preparations

Step 1. Connect the special communications adapter, sold separately, to the connector on the back of the printer terminal (refer to section 9. "Preparation").

Step 2. Connect the mini-pin jack end of the special communications adapter to the blood pressure monitor (UB PC series).

Step 3. The blood pressure monitor display will change to



Step 4. When the display changes communication preparations are complete.

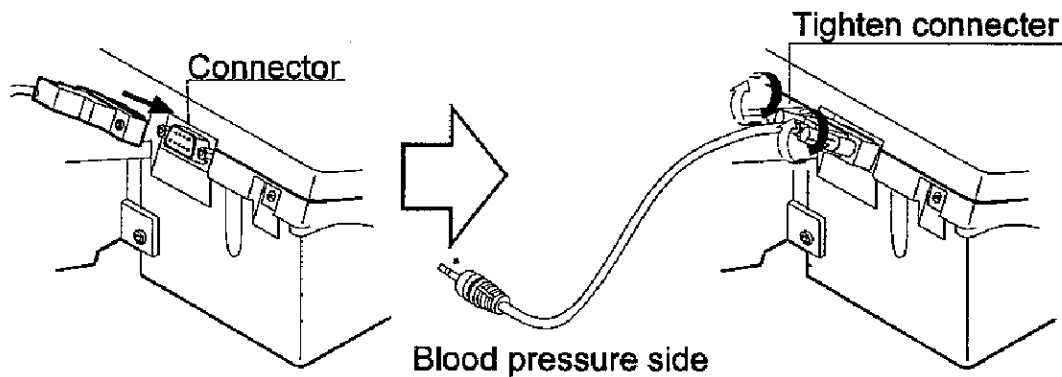

⚠ Caution!

- When the unit is left with the communication cable inserted in the blood pressure monitor, the batteries will rapidly drain. Therefore, when communications are complete, remove the cable. When the cable is removed the blood pressure monitor will return to the clock display.
- The preparation procedure is different about several blood pressure monitors. Refer to each instruction manual of the blood pressure monitor.

10.4.2. Data Upload and Printing

Explanation

- Press the UPLOAD PRINT key then immediately press the start switch on the blood pressure monitor. Measurement data will be uploaded from the blood pressure monitor. Measurement results will then be printed using the standard report format.
With model 3 the report format cannot be selected.
- When measurement data is uploaded, the **[BPM]** indicator is displayed. Measurement data uploading is complete when this indicator is displayed. The communication cable can be unplugged from the blood pressure monitor at this time.

Procedure

- Step 1. Confirm that communication preparations are complete (refer to section 10.4.1 "Communication preparations").
- Step 2. Press the UPLOAD/PRINT key. The printer will enter the communication wait mode.
- Step 3. Immediately press the start switch of the blood pressure monitor. Measurement data will be sent from the blood pressure monitor.
- Step 4. The measurement data will be uploaded to the printer and the **[BPM]** indicator is displayed when uploading is complete.
- Step 5. Next, printing will begin. The **[PRINT]** indicator will blink during printing.
- Step 6. The **[PRINT]** indicator will go out when printing is complete.

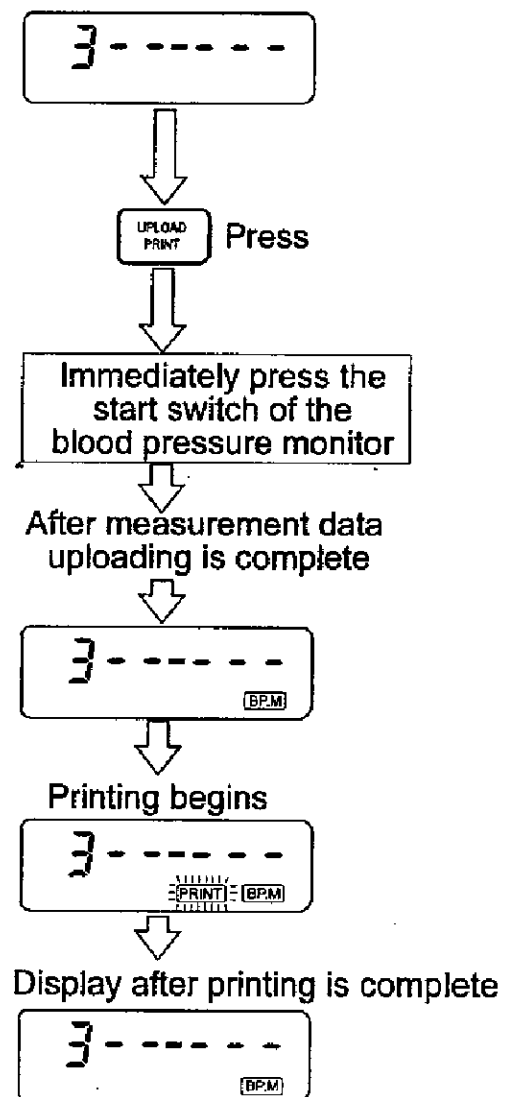

11. Maintenance

11.1. Cleaning

- When cleaning the unit, first turn the power off and unplug the AC adapter from the printer terminal. In addition, remove the batteries, if present, after the power is turned off.
- Wipe the unit with a dry cloth.
- When the printer is too dirty, clean using a well-wrung cloth wet with a neutral cleaner.
- The printer terminal is not waterproof. Do not wet the unit when cleaning.
- Do not clean using thinner or other organic solvents.

11.2. Before Requesting Repairs

- Do not open the case and do not allow anyone other than authorized personnel to repair the unit. Such repairs may cause damage or fires.
- Before assuming that the unit is broken, try solving the problem by matching the error number displayed on the LCD with the measures described below. If the problem persists, contact the nearest business representative of A & D Co., Ltd.

Notice

When an error is displayed the power must first be turned off before operation can be started again. Turn the power off, then on again.

Error number	Error content	Cause or countermeasure for problem
E01	Memory error	- Remove the AC adapter or batteries and insert again. Turn the power on. If the error re-appears, send the unit in for repair.
E02		
E11	Communication error	- Is the communication cable properly connected? - Do the connected blood pressure monitor and the selected model match? - Is the communication method correct? (when using model 1) - Have communication preparations been properly carried out? (preparations are different depending on the model)
E12	Infrared communication device error	- Remove the AC adapter or batteries and insert again. Turn the power on. If the error re-appears, send the unit in for repair.
E21	Paper jam	- Is the paper jammed?

12. Options

Part name	Order code
Printer paper (5 rolls)	AX-PP147-S
Communication cable (for models 1 and 2) The same cable as the accessory cable	AX-KO1502

13. Appendix

13.1. External Diagrams

TM-2480

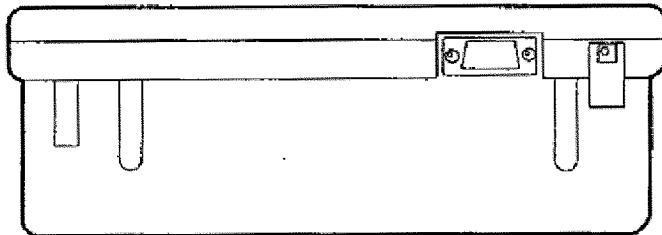

Back panel

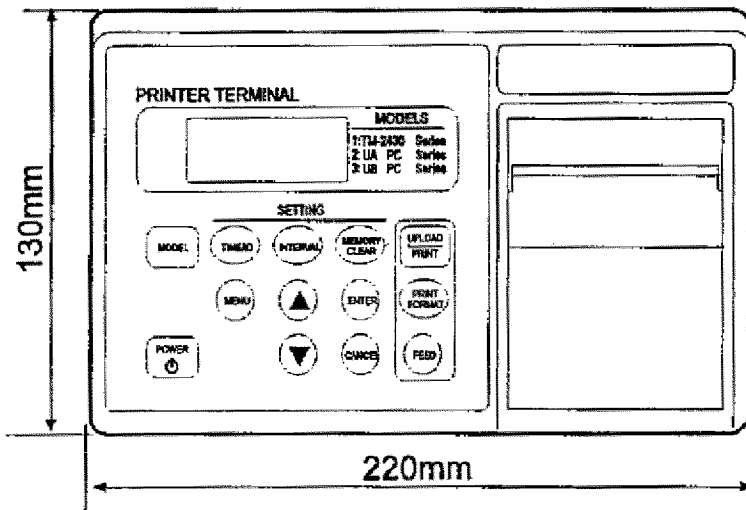

Front panel

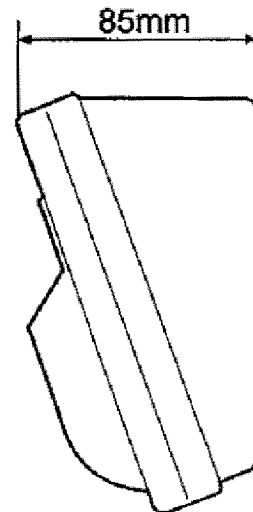

Side panel

TM-2481

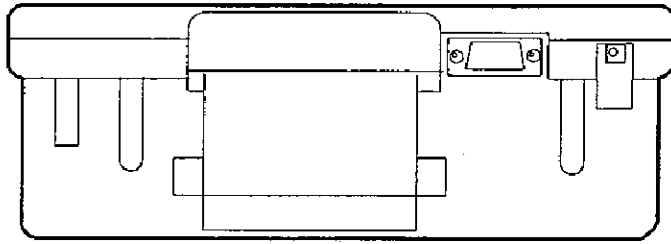

Back panel

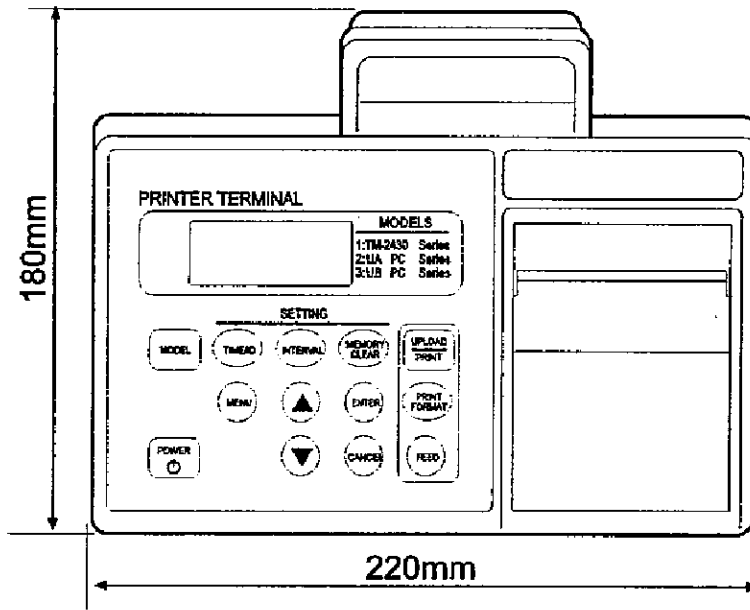

Front panel

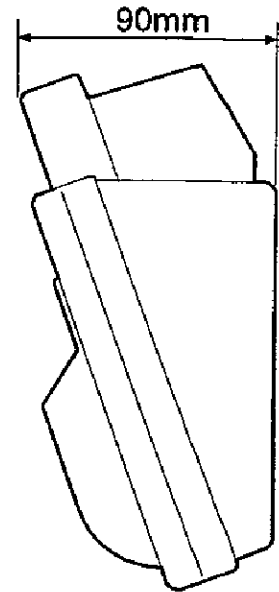

Side panel

13.2. Printout Examples

Printout example for TM-2430 series (printing is done in the sequence shown below every 24 hours)

```

TYPE: MODEL1<ABPM>
INTERVAL: MODE II
TYPE: MODEL1<ABPM>
10/22 1998 ID: 1
SYS DIA PUL [mmHg] PUL [1/min]
TIME DIA PUL PUL ERR
0:00 100 80 74 100
1:00 100 80 74 100
2:00 100 80 74 100
3:00 100 80 74 100
4:00 100 80 74 100
5:00 100 80 74 100
6:00 100 80 74 100
7:00 100 80 74 100
8:00 100 80 74 100
9:00 100 80 74 100
10:00 100 80 74 100
11:00 100 80 74 100
12:00 100 80 74 100
13:00 100 80 74 100
14:00 100 80 74 100
15:00 100 80 74 100
16:00 100 80 74 100
17:00 100 80 74 100
18:00 100 80 74 100
19:00 100 80 74 100
20:00 100 80 74 100
21:00 100 80 74 100
22:00 100 80 74 100
23:00 100 80 74 100
24:00 100 80 74 100
E07 *

```

Table

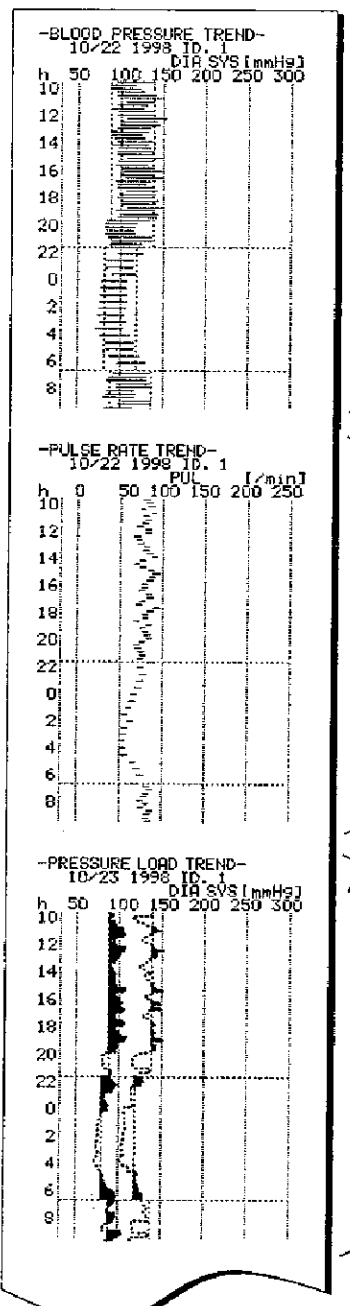

Blood pressure trend

Pulse trend

Pressure load trend

```

BLOCK1 0 TO 0 HOUR
SYS AVE=133 S.D.=12.7
DIA AVE=80 S.D.=10.0
PUL AVE=74 S.D.=9.3
PRESSURE LOAD
SYS>140/120: 67.4[mmHg-h]
DIA>90/80: 146.9[mmHg-h]
TOTAL<24H> 10 TO 10 HOUR
SYS AVE=133 S.D.=12.7
DIA AVE=80 S.D.=10.0
PUL AVE=74 S.D.=9.3
PRESSURE LOAD
SYS>140/120: 67.4[mmHg-h]
DIA>90/80: 146.9[mmHg-h]
ERR RATE : 1.21%
AWAKE 7 TO 22 HOUR
SYS AVE=133 S.D.=12.7
DIA AVE=80 S.D.=10.0
PUL AVE=74 S.D.=9.3
PRESSURE LOAD
SYS>140 : 34.8[mmHg-h]
DIA>90 : 107.0[mmHg-h]
SLEEP 22 TO 7 HOUR
SYS AVE=120 S.D.=10.0
DIA AVE=80 S.D.=9.0
PUL AVE=68 S.D.=8.0
PRESSURE LOAD
SYS>120 : 32.6[mmHg-h]
DIA>80 : 39.1[mmHg-h]

```

Statistical data printout

```

BLOCK1      0 TO 0 HOUR
            N= 79
SVS AVE=133 S.D.= 12.7
DIA AVE= 93 S.D.= 10.5
PUL AVE= 74 S.D.=  9.4
PRESSURE LOAD
SVS>140/120: 67.4[mmHg-h]
DIA> 90/ 80: 146.9[mmHg-h]

TOTAL<24H> 10 TO 10 HOUR
            N= 79
SVS AVE=133 S.D.= 12.7
DIA AVE= 93 S.D.= 10.5
PUL AVE= 74 S.D.=  9.4
PRESSURE LOAD
SVS>140/120: 67.4[mmHg-h]
DIA> 90/ 80: 146.9[mmHg-h]
ERR RATE   : 1.21%

AWAKE      7 TO 22 HOUR
            N= 60
SVS AVE=138 S.D.=  9.6
DIA AVE= 93 S.D.=  7.0
PUL AVE= 73 S.D.=  6.4
PRESSURE LOAD
SVS>140 : 34.8[mmHg-h]
DIA> 90 : 107.8[mmHg-h]

SLEEP     22 TO 7 HOUR
            N= 19
SVS AVE=120 S.D.= 10.1
DIA AVE= 81 S.D.= 10.1
PUL AVE= 64 S.D.=  9.4
PRESSURE LOAD
SVS> 120: 32.6[mmHg-h]
DIA>  80: 39.1[mmHg-h]
    
```

Printed for each measurement interval block.
 However, since measurement interval block information is uploaded simultaneously with measurement data, the blocks here do not depend on the blocks used during actual measurement.

Statistical results for 24 hour period

Statistical results while awake

Statistical results while a sleep

```

BLOCK1      6 TO 18 HOUR
            N= 49
SVS AVE=137 S.D.=  9.6
DIA AVE= 92 S.D.=  9.6
PUL AVE= 73 S.D.=  9.0
PRESSURE LOAD
SVS>140/120: 37.9[mmHg-h]
DIA> 90/ 80: 102.7[mmHg-h]

BLOCK2     18 TO 22 HOUR
            N= 16
SVS AVE=139 S.D.= 10.1
DIA AVE= 94 S.D.=  9.1
PUL AVE= 73 S.D.=  7.9
PRESSURE LOAD
SVS>140/120: 11.8[mmHg-h]
DIA> 90/ 80: 22.1[mmHg-h]

BLOCK3     22 TO 6 HOUR
            N= 17
SVS AVE=119 S.D.=  9.6
DIA AVE= 80 S.D.= 10.1
PUL AVE= 63 S.D.=  9.6
PRESSURE LOAD
SVS>140/120: 17.6[mmHg-h]
DIA> 90/ 80: 22.1[mmHg-h]

TOTAL<24H> 10 TO 10 HOUR
            N= 79
SVS AVE=133 S.D.= 12.7
DIA AVE= 93 S.D.= 10.5
PUL AVE= 74 S.D.=  9.4
PRESSURE LOAD
SVS>140/120: 67.4[mmHg-h]
DIA> 90/ 80: 146.9[mmHg-h]
ERR RATE   : 1.21%

AWAKE      7 TO 22 HOUR
            N= 60
SVS AVE=138 S.D.=  9.6
DIA AVE= 93 S.D.=  7.0
PUL AVE= 73 S.D.=  6.4
PRESSURE LOAD
SVS>140 : 34.8[mmHg-h]
DIA> 90 : 107.8[mmHg-h]

SLEEP     22 TO 7 HOUR
            N= 19
SVS AVE=120 S.D.= 10.1
DIA AVE= 81 S.D.= 10.1
PUL AVE= 64 S.D.=  9.4
PRESSURE LOAD
SVS> 120: 32.6[mmHg-h]
DIA>  80: 39.1[mmHg-h]
    
```

This example shows the printout with only the measurement interval blocks changed. The base data used to obtain the above statistical data was also used here.

Changed to 3 blocks

The method for changing the measurement interval into 3 blocks, as shown in the example at right, is shown below.

- Change method**
- Step 1. Set the blood pressure monitor to the connected mode.
 - Step 2. Change the measurement interval blocks of the blood pressure monitor (refer to section 10.2.5 "Measurement interval settings")
 - Step 3. Press the UPLOAD PRINT key.

The TOTAL (24H)/AWAKE/SLEEP content will be the same as the above printout.

Statistical data printout

```

BLOCK1 0 TO 0 HOUR
N=79
SYS AVE=133 S.D.=12.0
DIA AVE=93 S.D.=10.3
PUL AVE=74 S.D.=9.3
PRESSURE LOAD
SYS>140/120: 67.4[mmHg·h]
DIA>90/80: 146.9[mmHg·h]

TOTAL<24H> 10 TO 10 HOUR
N=79
SYS AVE=133 S.D.=12.0
DIA AVE=93 S.D.=10.3
PUL AVE=74 S.D.=9.3
PRESSURE LOAD
SYS>140/120: 67.4[mmHg·h]
DIA>90/80: 146.9[mmHg·h]
ERR RATE : 1.21%

AWAKE 7 TO 22 HOUR
N=60
SYS AVE=138 S.D.=9.0
DIA AVE=97 S.D.=10.2
PUL AVE=79 S.D.=6.4
PRESSURE LOAD
SYS>140 : 34.8[mmHg·h]
DIA>90 : 107.8[mmHg·h]

SLEEP 22 TO 7 HOUR
N=19
SYS AVE=120 S.D.=10.2
DIA AVE=81 S.D.=10.5
PUL AVE=64 S.D.=9.3
PRESSURE LOAD
SYS>120: 32.6[mmHg·h]
DIA>80: 39.1[mmHg·h]
    
```

Block time zone
 Number of data points within this time zone
 Average (AVE) SYS/DIA/PUL values and standard deviation (S.D.)
 Pressure load

Threshold systolic pressure during awake time
 Threshold systolic pressure during sleep time
 SYS>140/120: 67.4[mmHg·h]
 Total surface area under measurements exceeding the threshold value (darkened area)

SYS: Systolic blood pressure
 DIA: Diastolic blood pressure

Pressure load trend

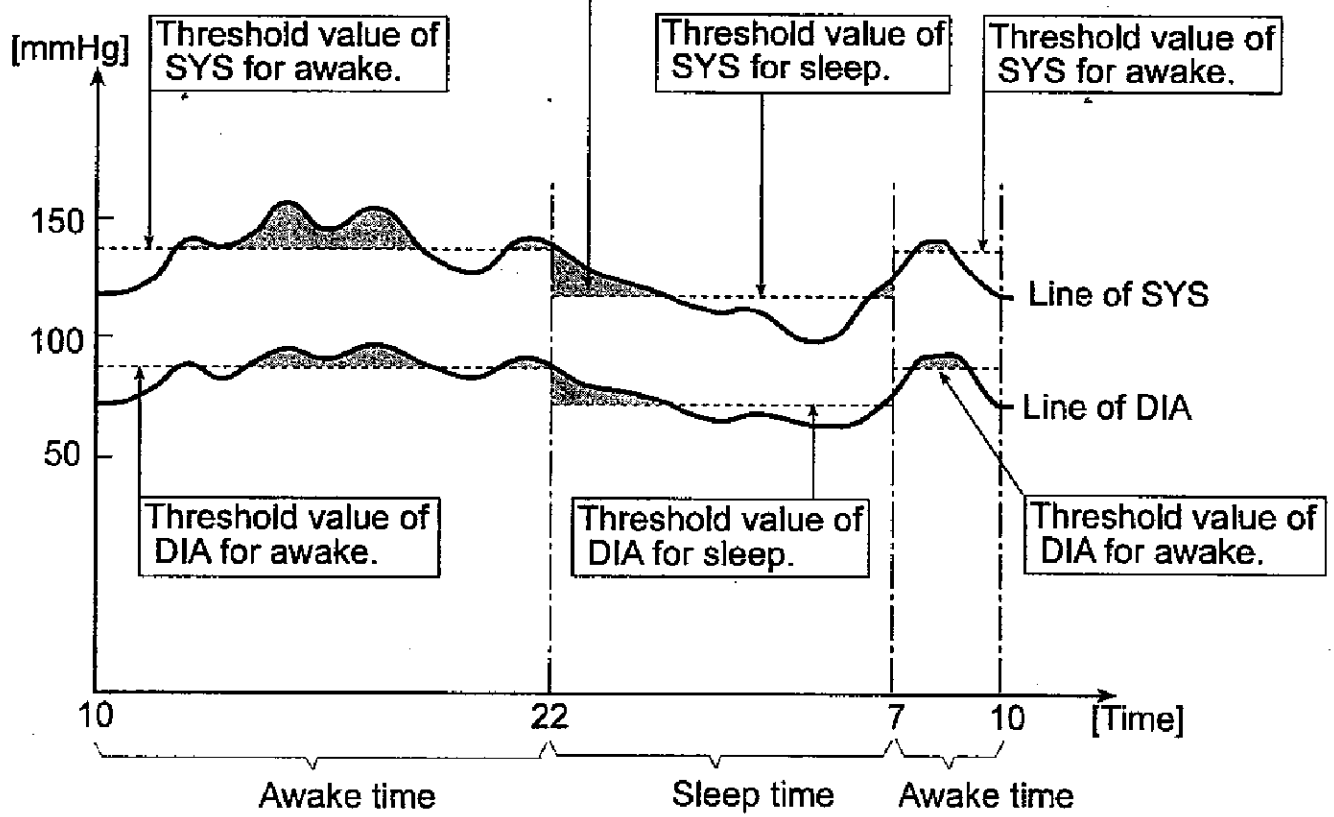

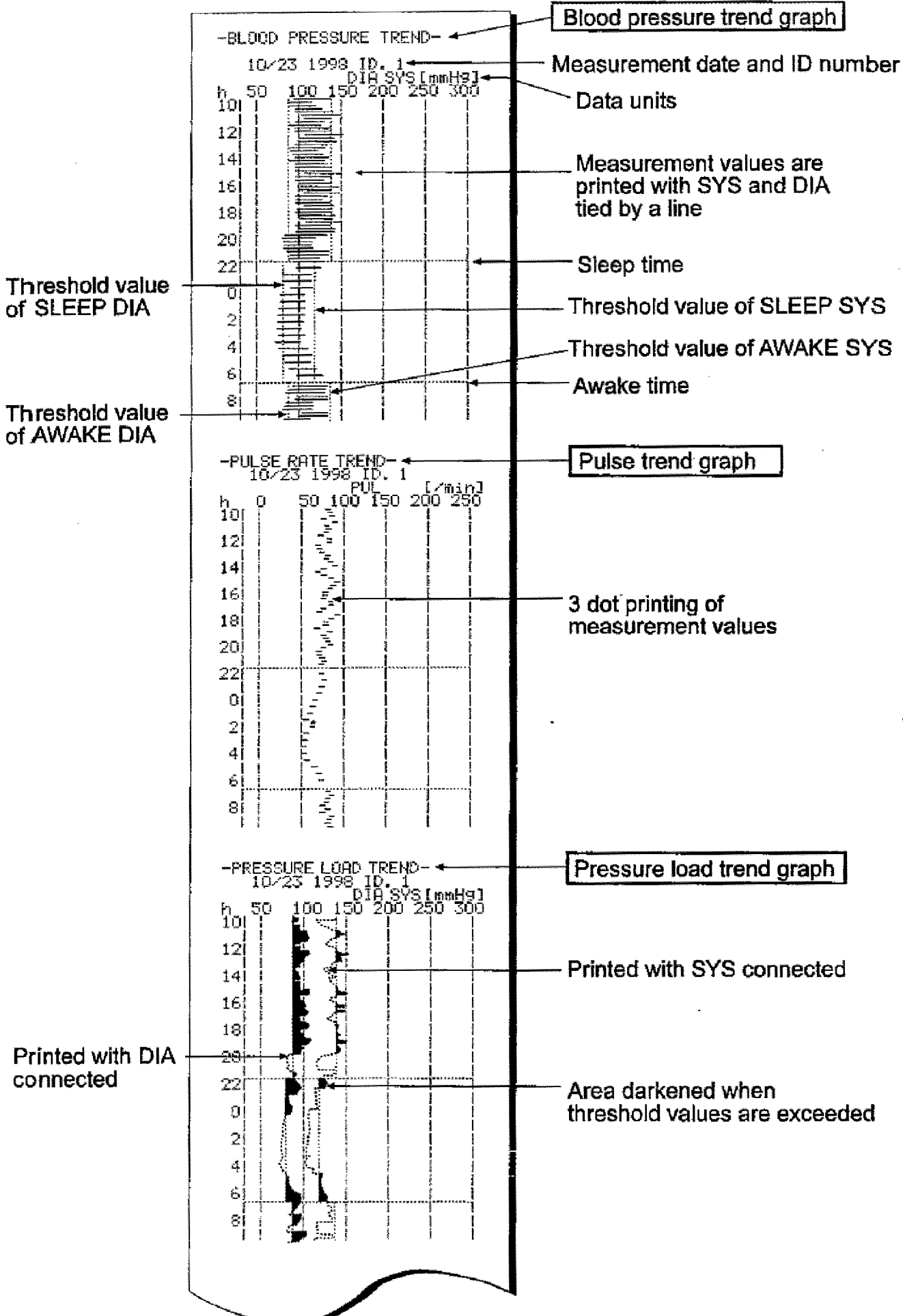

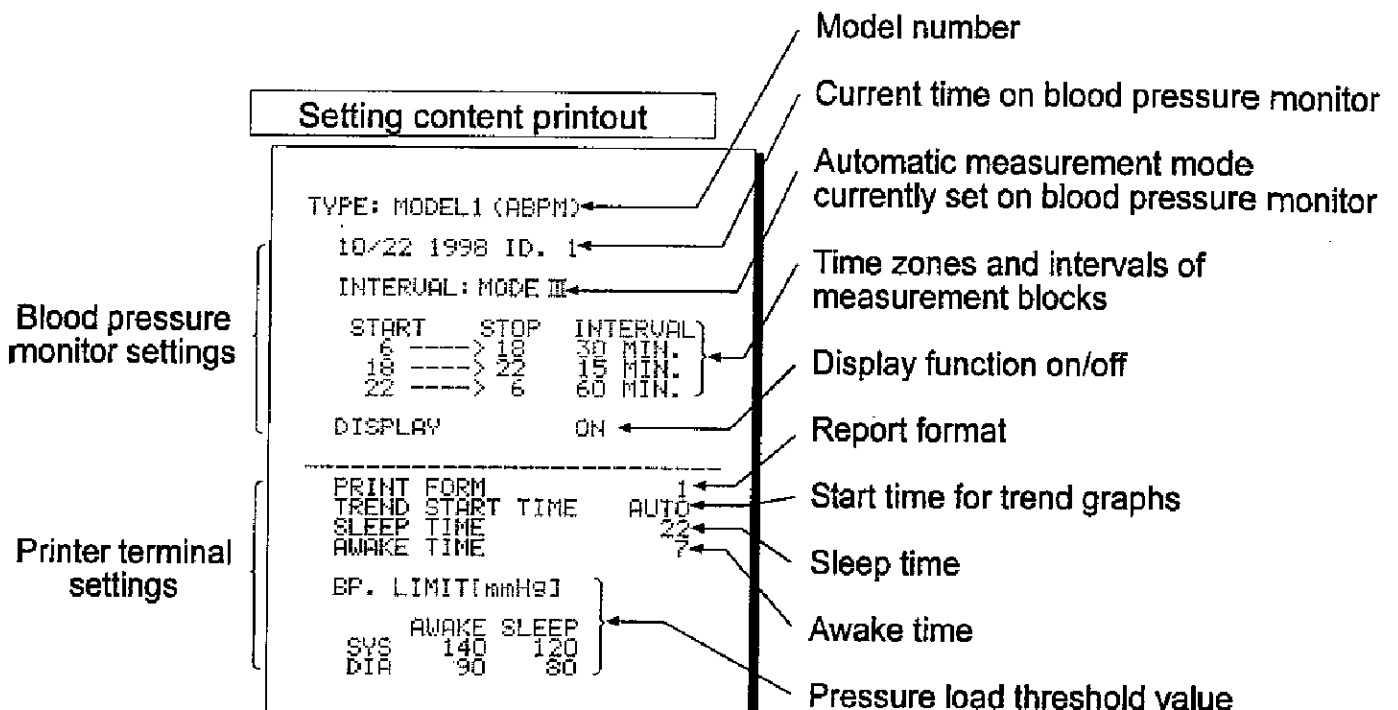

```

Setting content printout
TYPE: MODEL1 (ABPM)
10/22 1998 ID. 1
INTERVAL: MODE III
  START   STOP   INTERVAL
  6 -----> 18   30 MIN.
  18 -----> 22   15 MIN.
  22 -----> 6    60 MIN.
DISPLAY      ON
-----
PRINT FORM   1
TREND START TIME AUTO
SLEEP TIME   22
AWAKE TIME   7
BP. LIMIT [mmHg]
  SYS  AWAKE SLEEP
  DIA   90  120  80
  
```

Printout when TIME/ID setting is complete

```

TYPE: MODEL1 (ABPM)
1 DISPLAY      ON
2 I.D. NO.     1
3 YEAR        1998
4 MONTH       10
5 DAY         22
6 HOUR        10
7 MINUTES     3
  
```

Printout when INTERVAL setting is complete

```

TYPE: MODEL1 (ABPM)
INTERVAL: MODE I
  START   STOP   INTERVAL
  7 -----> 22   15 MIN.
  22 -----> 7    30 MIN.
TYPE: MODEL1 (ABPM)
INTERVAL: MODE II
  DURING   INTERVAL
  ISJMARK OFF 15 MIN.
  ISJMARK ON  30 MIN.
TYPE: MODEL1 (ABPM)
INTERVAL: MODE III
  START   STOP   INTERVAL
  6 -----> 18   30 MIN.
  18 -----> 22   15 MIN.
  22 -----> 6    60 MIN.
  
```

- Model number
- Example for automatic measurement mode I Fixed
- Example for automatic measurement mode II Fixed
- Example for automatic measurement mode III
- Block 1
- Block 2
- Block 3
- This is only an example. The newly input settings are printed.

TYPE: MODEL2 (B CBPM)

1998

DATE	TIME	SYS [mmHg]	DIA [mmHg]	PUL [1/min]
11/01	11:11	111	74	111
11/02	11:11	111	74	111
11/03	11:11	111	74	111
11/04	11:11	111	74	111
11/05	11:11	111	74	111
11/06	11:11	111	74	111
11/07	11:11	111	74	111
11/08	11:11	111	74	111
11/09	11:11	111	74	111
11/10	11:11	111	74	111
11/11	11:11	111	74	111
11/12	11:11	111	74	111
11/13	11:11	111	74	111
11/14	11:11	111	74	111
11/15	11:11	111	74	111
11/16	11:11	111	74	111
11/17	11:11	111	74	111
11/18	11:11	111	74	111
11/19	11:11	111	74	111
11/20	11:11	111	74	111
11/21	11:11	111	74	111
11/22	11:11	111	74	111
11/23	11:11	111	74	111
11/24	11:11	111	74	111
11/25	11:11	111	74	111
11/26	11:11	111	74	111
11/27	11:11	111	74	111
11/28	11:11	111	74	111
11/29	11:11	111	74	111
11/30	11:11	111	74	111
12/01	11:11	111	74	111
12/02	11:11	111	74	111
12/03	11:11	111	74	111
12/04	11:11	111	74	111
12/05	11:11	111	74	111
12/06	11:11	111	74	111
12/07	11:11	111	74	111
12/08	11:11	111	74	111
12/09	11:11	111	74	111
12/10	11:11	111	74	111
12/11	11:11	111	74	111
12/12	11:11	111	74	111
12/13	11:11	111	74	111
12/14	11:11	111	74	111
12/15	11:11	111	74	111
12/16	11:11	111	74	111
12/17	11:11	111	74	111
12/18	11:11	111	74	111
12/19	11:11	111	74	111
12/20	11:11	111	74	111
12/21	11:11	111	74	111
12/22	11:11	111	74	111
12/23	11:11	111	74	111
12/24	11:11	111	74	111
12/25	11:11	111	74	111
12/26	11:11	111	74	111
12/27	11:11	111	74	111
12/28	11:11	111	74	111
12/29	11:11	111	74	111
12/30	11:11	111	74	111
12/31	11:11	111	74	111

NOV. 1998	PUL [1/min]
NOV 01	111
NOV 05	111
NOV 09	111
NOV 13	111
NOV 17	111
NOV 21	111
NOV 25	111
NOV 29	111

DEC. 1998	PUL [1/min]
DEC 01	111
DEC 05	111
DEC 09	111
DEC 13	111
DEC 17	111
DEC 21	111
DEC 25	111
DEC 29	111

TOTAL	PUL [1/min]
TOTAL	111

Table
All data is printed

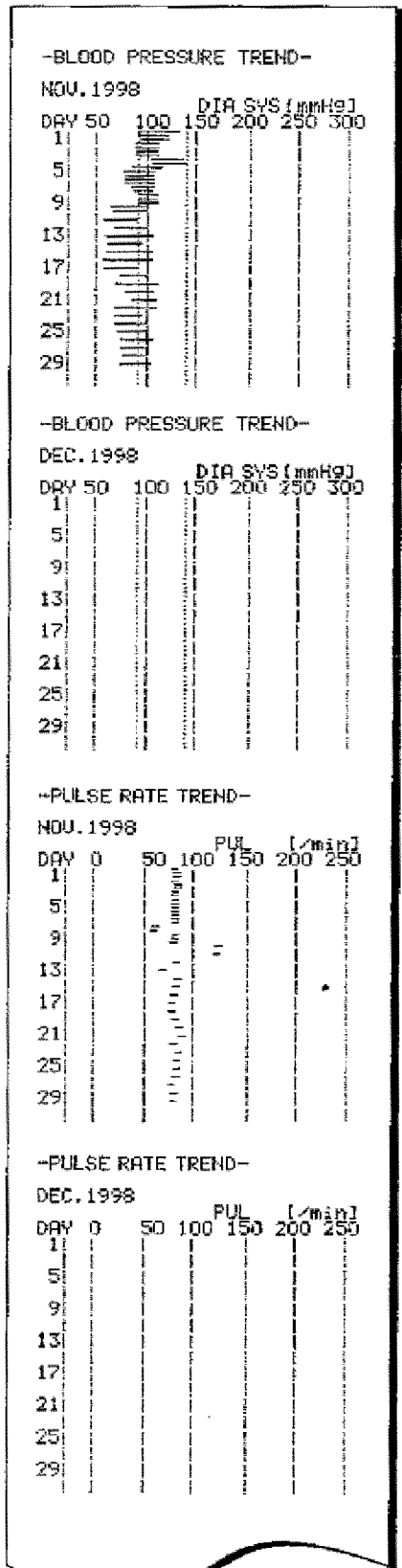

Blood pressure trend
Printed with values for each month collected together

Pulse trend
Printed with values for each month collected together

TYPE: MODEL2 (8 CBPM)

Model number
Year of measurement
Data units

1998

SYS DIA [mmHg] PUL [1/min]

DATE	TIME	SYS	DIA	PUL
11/01	10:00	120	80	70
11/02	10:00	110	75	65
11/03	10:00	125	85	75
11/04	10:00	115	78	68
11/05	10:00	120	82	72
11/06	10:00	118	80	70
11/07	10:00	122	84	74
11/08	10:00	116	79	69
11/09	10:00	124	86	76
11/10	10:00	119	81	71
11/11	10:00	121	83	73
11/12	10:00	117	80	70
11/13	10:00	123	85	75
11/14	10:00	118	80	70
11/15	10:00	120	82	72
11/16	10:00	116	78	68
11/17	10:00	122	84	74
11/18	10:00	119	81	71
11/19	10:00	121	83	73
11/20	10:00	117	79	69
11/21	10:00	124	86	76
11/22	10:00	119	81	71
11/23	10:00	121	83	73
11/24	10:00	117	79	69
11/25	10:00	123	85	75
11/26	10:00	118	80	70
11/27	10:00	120	82	72
11/28	10:00	116	78	68
11/29	10:00	122	84	74
11/30	10:00	119	81	71

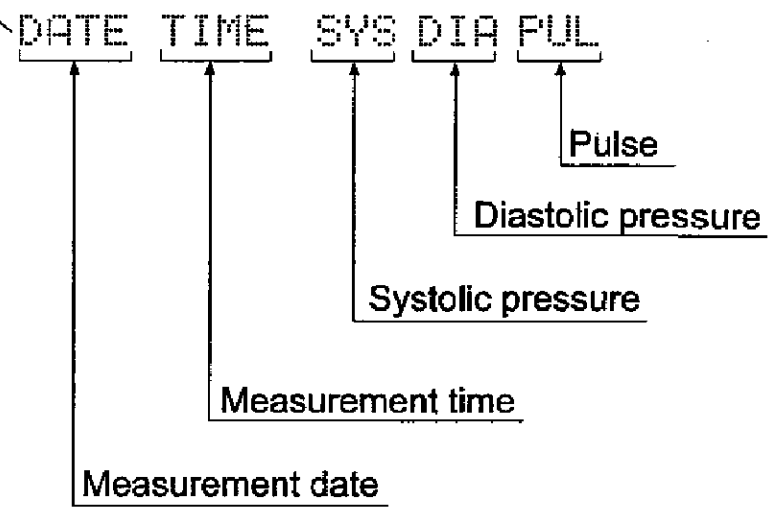

Month	SYS AVE	DIA AVE	PUL AVE	NO.
NOV. 1998	117	80	72	30
DEC. 1998	117	80	72	30
TOTAL	117	80	72	60

Statistical results for each month
Statistical results for all data

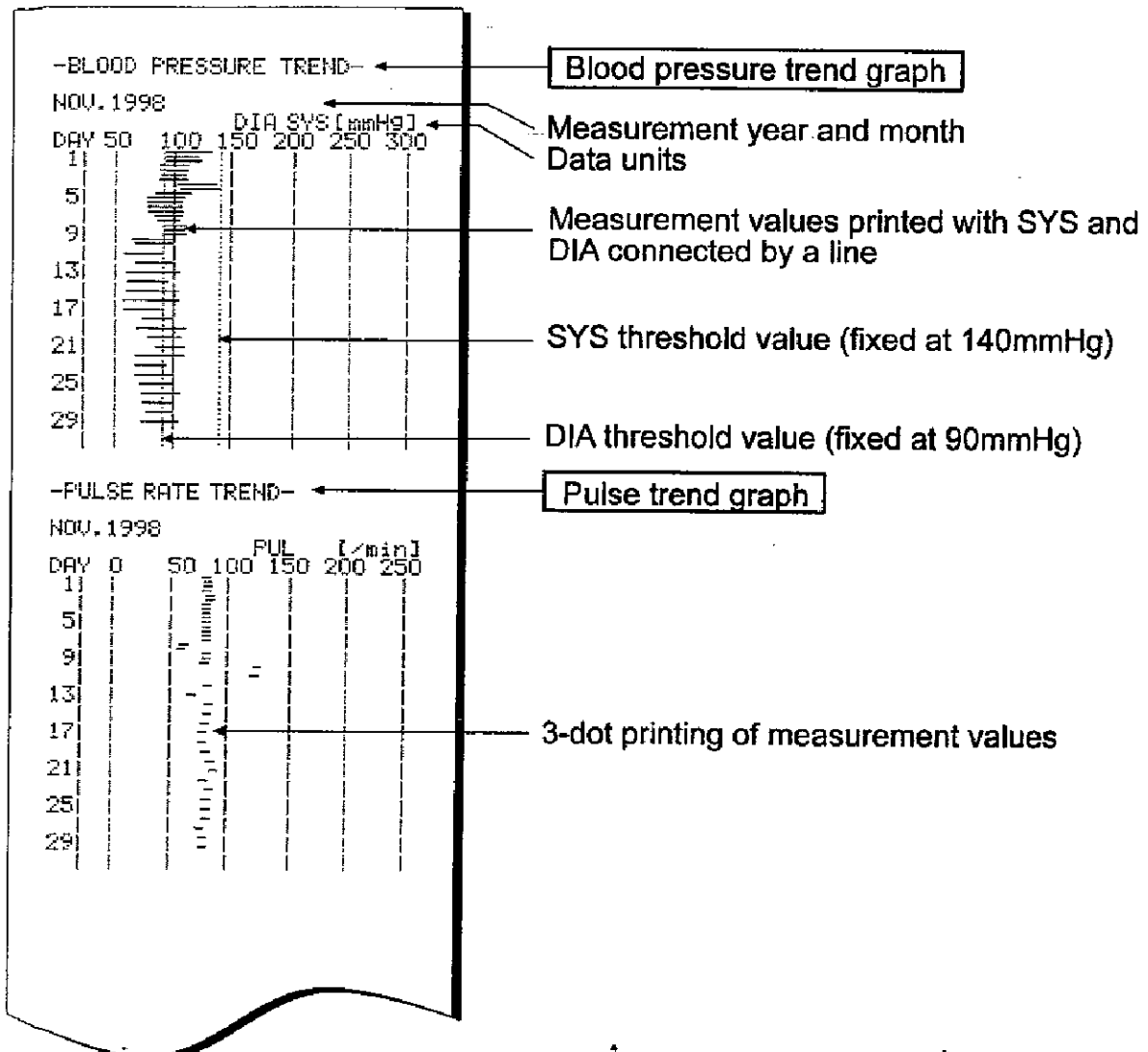

Blood pressure trend graph

Measurement year and month
Data units

Measurement values printed with SYS and DIA connected by a line

SYS threshold value (fixed at 140mmHg)

DIA threshold value (fixed at 90mmHg)

Pulse trend graph

3-dot printing of measurement values

UA PC Series

TYPE: MODEL2 (8 CBPM)

MEASUREMENT TIME

1	10:00
2	12:30
3	16:00
4	20:00
5	22:00
6	6:30

TYPE: MODEL2 (8 CBPM)

5	YEAR	1999
6	MONTH	11
7	DAY	10
8	HOUR	10
9	MINUTES	13

Model number

Alarm settings

Internal clock setting

AND

A&D Co., LTD.

1-243 Asahi, Kitamoto-shi, Saitama, 364-8585 JAPAN
Telephone: [81] (485) 93-1111 Fax: [81] (485) 93-1119

A&D INSTRUMENTS LTD.

<Authorized Representative Established in the European Community>
Abingdon Science Park, Abingdon, Oxford OX14 3YS ENGLAND
Telephone: [44] (1235) 550420 Fax: [44] (1235) 550485