

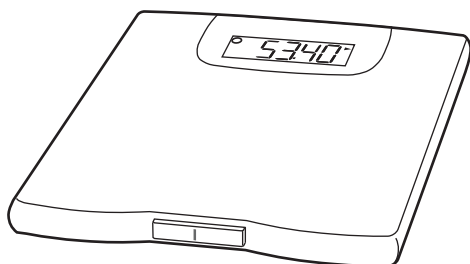

Instruction Manual

Precision Health Scale Model UC-321



Before Use

Precautions	1
Scale Components	2
Display Symbols	3
Installing (or Replacing) Batteries ..	3

Operations

Basic Measurement	4
Memory Function	6
Target Function	8
BMI Indication	10
Measuring Your Weight on a Carpet ..	12

References

Specifications	13
Maintaining the Scale	13
Before Requesting Service	13

Precautions

- Please read this booklet before using your scale.
- Place your scale on a solid level surface, such as tile, wood, or laminate flooring.
- Do not place your scale on a soft, wet or slippery floor. If the scale must be used on a carpet, be sure to attach the plastic add-on feet as shown on page 12.
- Your scale contains delicate, high-precision parts. Avoid extremes in temperature, humidity, direct sunlight, shock, moisture and dust.
- Do not step on your scale with your feet wet. Be sure that your feet are dry to prevent slipping and serious injury.
- Step on the center portion of your scale gently.
- Do not step on the display window.
- Do not open the case of the scale.
- Holding the measurement switch for extended periods will shorten battery life.



Indications for Use

- The UC-321 is designed for adult use at home.

Scale Components

Display

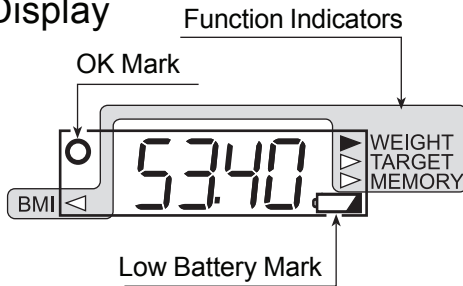

Front

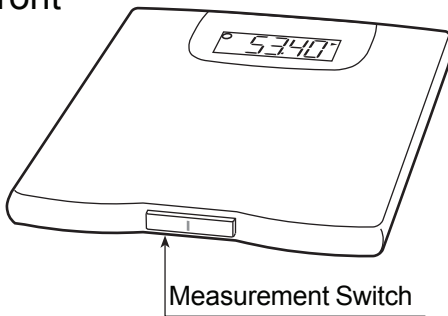

Back

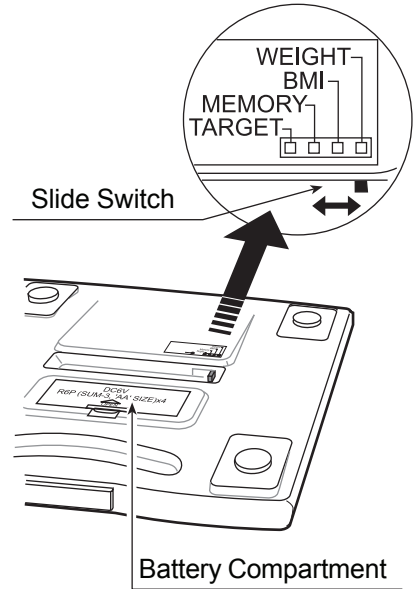

Function

□ The following four measurements can be selected by the **slide switch**.

WEIGHT	Refer to “Basic Measurement” and “Measuring a Baby or an Animal”. The function to measure your weight, the weight of a baby or animal.
BMI	Refer to “BMI Indication”. The BMI is a helpful indicator of body weight condition, in adults.
MEMORY	Refer to “Memory Function”. Up to 31 weight data can be stored in memory. The difference from the previous result is displayed automatically.
TARGET	Refer to “Target Function”. The difference between the preset target weight and the current weight can be displayed.



□ The scale has an “**automatic-power-off**” function to turn the scale off after ten seconds of non-operation. Therefore, the scale has no off switch.

Display Symbols

○	OK mark. This mark is displayed when measurement display is stable.
	Low battery mark. If this mark is displayed, replace all four batteries with new ones.
◀, ▶	Function indicators. The current function is indicated.

Installing (or Replacing) Batteries

Caution

- ❑ Insert each battery with its positive (+) and negative (-) terminals properly aligned with the corresponding marks in the battery compartment.
- ❑ Improper installation of the batteries may cause battery leakage.
- ❑ Replace all four batteries with new ones, when the  mark is displayed.
- ❑ Do not mix new and used batteries. It may cause damage to the scale or shorten battery life.
- ❑ When batteries are completely drained, the  mark is not displayed.
- ❑ The battery life is dependant upon the environmental temperature, battery type and usage.
- ❑ Remove the batteries from the battery compartment, when the scale is not to be used for a long time. They may leak and damage your scale.
- ❑ The accessory batteries may have a shorter life than new ones.

Steps for Installing (or Replacing) Batteries

- 1 Remove the battery compartment cover on the underside of the scale by gently pushing on the arrow and lifting the cover backward.
- 2 Install four new batteries with the positive (+) and negative (-) terminals properly aligned with the corresponding marks in the battery compartment.
- 3 Replace the cover by sliding it into the compartment and gently pressing into place.

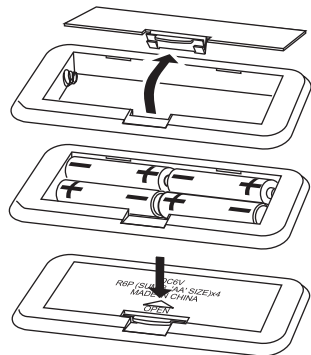

Basic Measurement

Measuring Your Weight

1 Set the slide switch to "WEIGHT".

2 Press the measurement switch gently.

All display segments are indicated for several seconds. Then, 0.00 kg and the ○ mark are displayed.

3 Step on your scale.

Step on your scale gently. When the ○ mark disappears, the measurement is started. Remain still during the measurement.

If 0.00 kg is displayed for approximately ten seconds, the scale is automatically turned off.

4 Your weight can be read after the ○ mark is displayed.

The scale is turned off automatically after approximately five seconds.

5 Step off the scale.

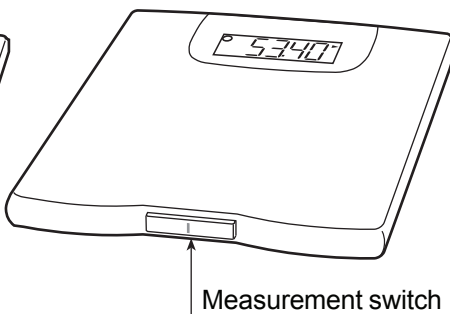
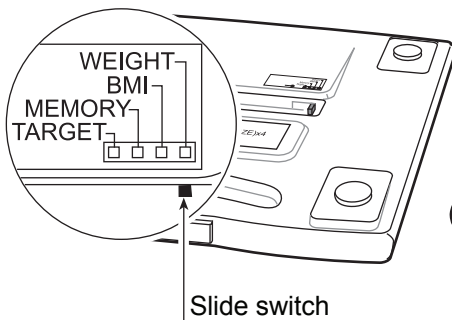
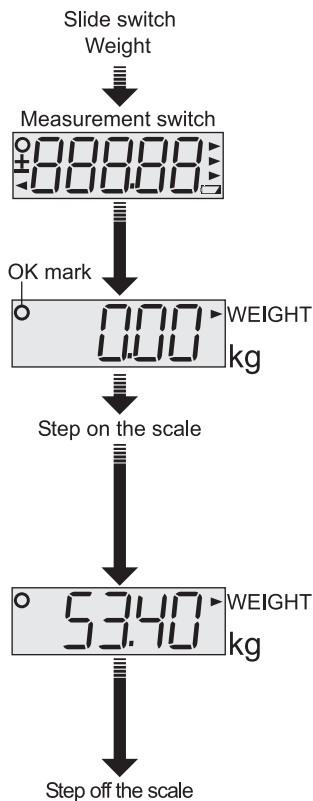

Measuring a Baby or an Animal

1 Set the slide switch to “WEIGHT”.

2 Press the measurement switch gently and immediately step on your scale.

With all of the display segments indicated (several seconds) and before 0.00 kg appears, step on the scale without any baby or animal in your hands. Wait for 0.00 kg to appear.

3 Step off the scale and pick up the baby or animal, then step on the scale again.

Within ten seconds after 0.00 kg and the ○ mark are displayed, step on your scale with the baby or animal. Remain still during the measurement until the ○ mark is displayed.

4 The weight of the baby or animal can be read after the ○ mark is displayed.

The scale is turned off automatically after approximately five seconds.

5 Step off the scale.

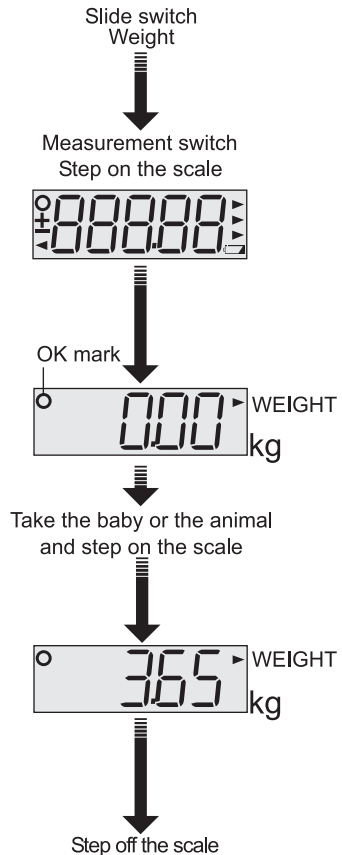

Memory Function

Up to 31 weight data can be stored in memory. The 32nd data is stored by deleting the oldest stored data. The difference from the previous result is displayed automatically.



Storing a Current Weight.

1 **Set the slide switch to “MEMORY”.**

2 **Press the measurement switch gently.**

The last weight is displayed.

3 **Step on your scale.**

When 0.00 kg and the  mark are displayed, step on your scale gently. The measurement is started when the  mark disappears. Remain still during the measurement. If 0.00 kg is displayed for approximately ten seconds, the scale is automatically turned off.

4 **The weight can be read after the  mark is displayed.**

5 **Step off the scale.**

6 **The weight is stored in memory and the difference from the last weight is displayed.**

The weight data is stored in memory and the difference from the previous result is displayed for approximately five seconds. And, the scale is automatically turned off.

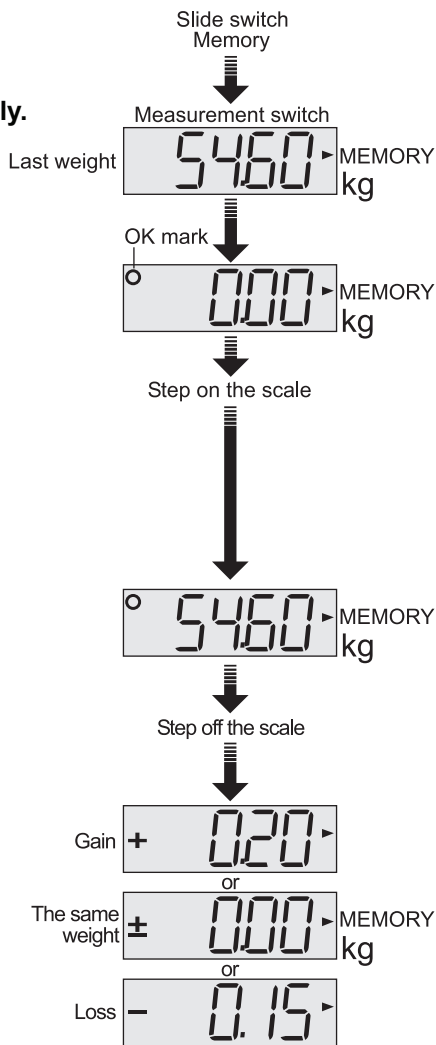

Displaying the Weight Data Stored in the Scale

The stored measurement data is displayed in order, beginning with the most recent measurement.

1 Set the slide switch to “MEMORY”.

Slide switch
Memory



2 With the scale turned off, press and hold the measurement switch gently.

Press and hold
measurement switch



The weight data are displayed in order from the last result. The scale is automatically turned off. If you want to stop displaying the data, press the measurement switch.

From last result in order

57.00 MEMORY
kg



53.55 MEMORY
kg

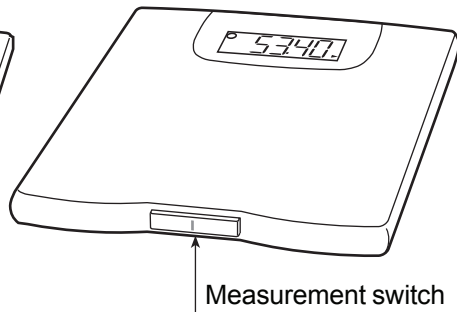
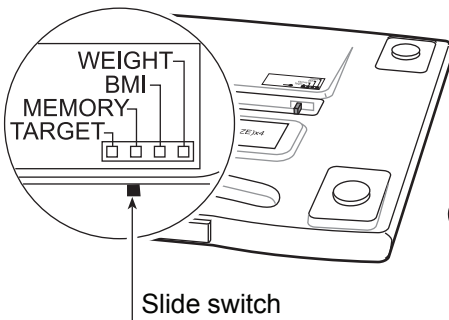

Target Function

The difference between the preset target weight and the current weight can be displayed.

Presetting a New Target Weight

1 **Set the slide switch to “TARGET”.**

2 **With the scale turned off, press and hold the measurement switch gently.**

The preset target weight is displayed.

3 **Using the measurement switch, set a new target weight.**

Press and release the measurement switch to increase the value in increments of 0.1.

Press and hold the measurement switch to increase the value continuously.

4 **When the desired value is displayed, release the measurement switch to store it.**

The scale is automatically turned off after the new target weight is displayed for approximately five seconds.

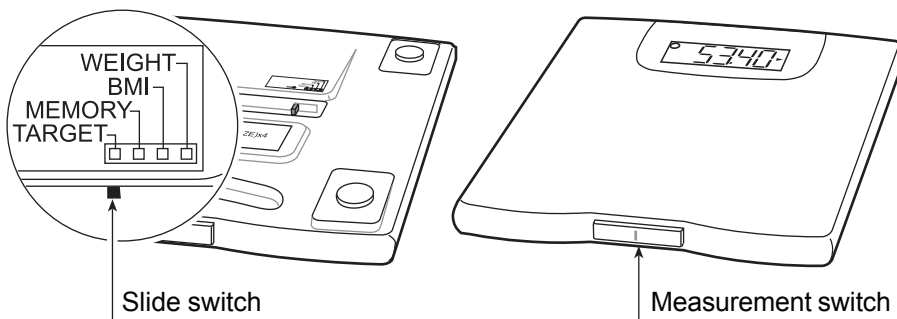
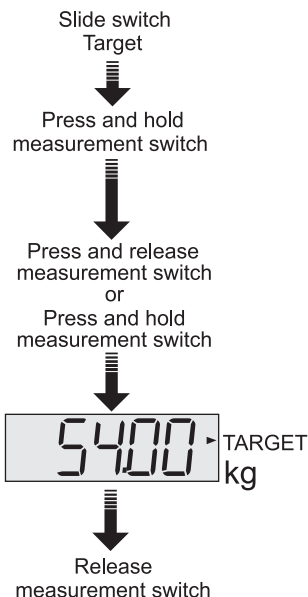

Comparing a Current Weight with a Preset Target Weight

1 Set the slide switch to “TARGET”.

Slide switch
Target

2 Press the measurement switch gently.

The stored target weight is displayed.

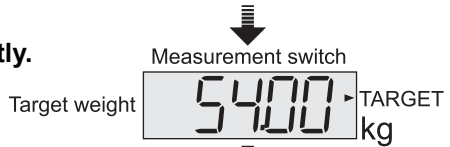

3 Step on the scale.

When 0.00 kg and the **O** mark are displayed, step on your scale gently.

The measurement is started when the **O** mark disappears. Remain still during the measurement.

If 0.00 kg is displayed for approximately ten seconds, the scale is automatically turned off.



Step on the scale

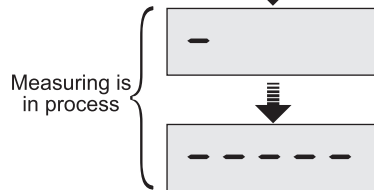

4 The difference between the preset target weight and the current weight is displayed.

The scale is automatically turned off after the difference is displayed for approximately five seconds.

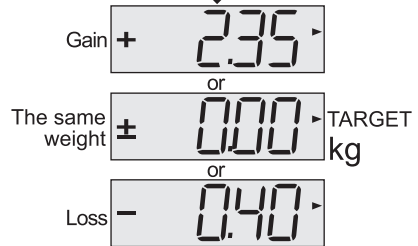

5 Step off the scale.

Step off the scale

BMI Indication

BMI

Body Mass Index or BMI (kg/m^2), based on an individual's height and weight, is a helpful indicator of underweight, overweight or obesity, in adults.

According to the new NHLBI (National Institutes of Health) guidelines, the BMI score is as indicated in the list.

Underweight	Below 18.5
Normal	18.5 to 24.9
Overweight	25.0 to 29.9
Obesity	30.0 and Above

$$\text{BMI} = \frac{\text{Weight (kg)}}{\text{Height (m)} \times \text{Height (m)}}$$

Presetting Your Height

Store your height before measuring your weight to calculate the BMI.

The scale can store a height between 30 cm and 220 cm in increments of 0.1 cm.

- 1 Set the slide switch to "BMI".**
- 2 With the scale turned off, press and hold the measurement switch gently.**
The preset height is displayed.
- 3 Using the measurement switch, set a new height.**
Press and release the measurement switch to increase the value in increments of 0.1.
Press and hold the measurement switch to increase the value continuously.
- 4 When the desired value is displayed, release the measurement switch to store it.**
The scale is automatically turned off after the new height is displayed for approximately five seconds.

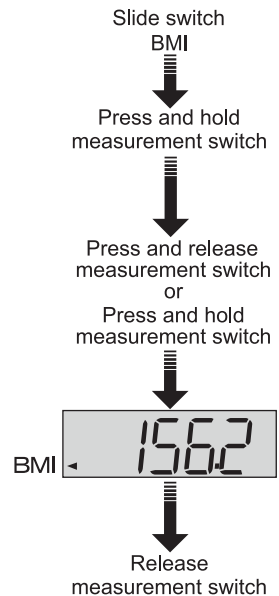



Displaying the BMI Score

1 **Set the slide switch to “BMI”.**

2 **Press the measurement switch gently.**

The preset height is displayed.

3 **Step on the scale.**

When 0.00 kg and the  mark are displayed, step on your scale gently. The measurement is started when the  mark disappears. Remain still during the measurement.

If 0.00 kg is displayed for approximately ten seconds, the scale is automatically turned off.

4 **The preset height and calculated BMI score are displayed alternately.**

The scale is automatically turned off after the preset height and calculated BMI score are displayed for approximately ten seconds.

5 **Step off the scale.**

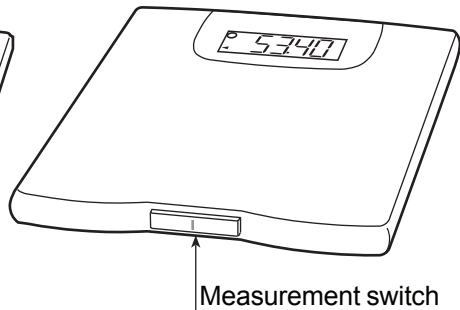
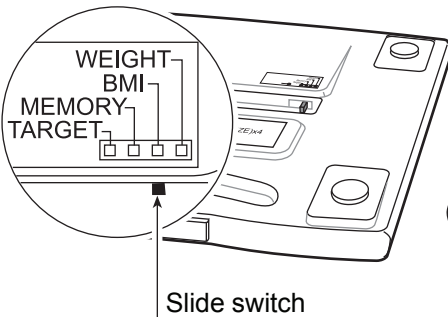
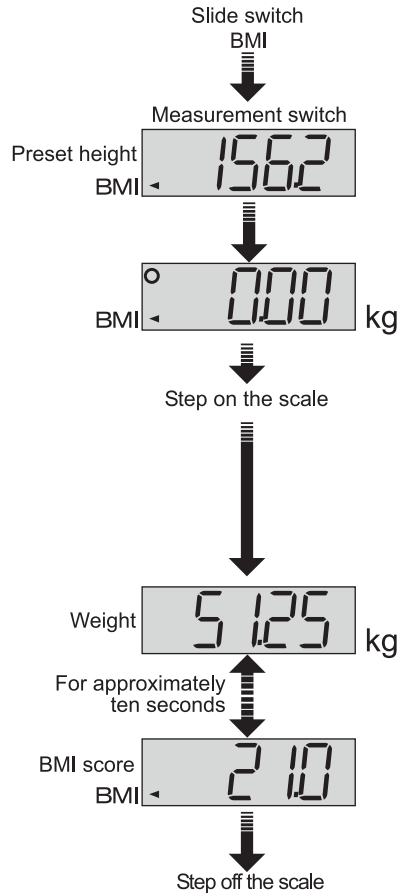

Measuring Your Weight on a Carpet

Place the scale on a solid level surface, such as tile, wood, or laminate flooring. If the scale must be used on a carpet, be sure to attach the plastic add-on feet.

Steps for Attaching the Add-on Feet

- 1 Each add-on foot has two pins. Match those pins to the holes on the scale leg and insert firmly.
- 2 Attach add-on feet to all four legs.

Notes

- Please be careful not to fall when using the add-on feet.
- We recommend using this scale on a solid and level surface.

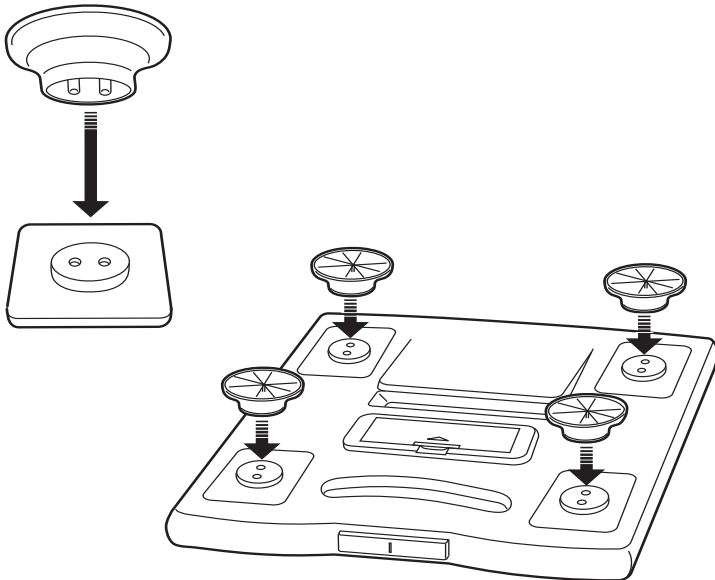

Specifications

Digital display	Liquid crystal display, 25 mm character height
Maximum capacity	150 kg
Minimum display	0.05 kg
Power source	Four type AA batteries (R6P, 1.5 volt x 4)
Battery life	Approximately 2000 measurements
Accessories	Instruction manual, Add-on feet (4), Batteries (4)

Specifications are subject to change without prior notice and any obligation on the part of the manufacturer.

Maintaining the Scale

- Clean the scale with a dry, soft cloth or a cloth moistened with water and a mild detergent. Never use alcohol, benzene, thinner or other harsh chemicals to clean the scale.
- Remove the batteries, if the scale is not going to be used for a long time.

Before Requesting Service

If this happens	Please do this
Nothing is displayed by pressing the measurement switch.	Check the battery installation. Replace with four new batteries.
The indication is fixed to <i>88888</i> . <i>H</i> or <i>L</i> is displayed.	Remove and reinstall the batteries.
The difference between an estimated weight and a measured weight is bigger.	Move your scale to a flat, solid surface. Does the scale bottom touch the floor?
<i>E - 0</i> is displayed.	Replace batteries and try again.

If you can not locate and fix the problem, contact your supplier, or the A&D service group. The A&D service group will support authorized suppliers about technical information, spare parts and units.



A&D Company, Limited

1-243 Asahi , Kitamoto-shi, Saitama 364-8585, JAPAN
Telephone: [81] (48) 593-1111 Fax: [81] (48) 593-1119

A&D INSTRUMENTS LIMITED

Unit 24/26 Blacklands Way, Abingdon Business Park, Abingdon, Oxfordshire OX14 1DY United Kingdom
Telephone: [44] (1235) 550420 Fax: [44] (1235) 550485

A&D ENGINEERING, INC.

1756 Automation Parkway, San Jose, California 95131, U.S.A.
Telephone: [1] (408) 263-5333 Fax: [1] (408)263-0119

A&D AUSTRALASIA PTY LTD

32 Dew Street, Thebarton, South Australia 5031, AUSTRALIA
Telephone: [61] (8) 8301-8100 Fax: [61] (8) 8352-7409

A&D KOREA Limited

한국에이.엔.디(주)
서울특별시 영등포구 국제금융로6길33 (여의도동) 맨하탄빌딩 817 우편 번호 07331
(817, Manhattan Bldg., 33. Gukjegeumyung-ro 6-gil, Yeongdeungpo-gu, Seoul, 07331 Korea)
전화: [82] (2) 780-4101 팩스: [82] (2) 782-4264

ООО A&D RUS

ООО "Эй энд Ди Рус"
121357, Российская Федерация, г.Москва, ул. Верейская, дом 17
(Business-Center "Vereyskaya Plaza-2" 121357, Russian Federation, Moscow, Vereyskaya Street 17)
тел.: [7] (495) 937-33-44 факс: [7] (495) 937-55-66

爱安德技研贸易(上海)有限公司

A&D Technology Trading(Shanghai) Co. Ltd

中国 上海市浦东新区 浦东南路855号 世界广场 32楼CD座 邮编200120
(32CD, World Plaza, No.855 South Pudong Road, Pudong New Area, Shanghai, China 200120)
电话: [86] (21) 3393-2340 传真: [86] (21) 3393-2347

A&D INSTRUMENTS INDIA PRIVATE LIMITED

509, Udyog Vihar, Phase-V, Gurgaon - 122 016, Haryana, India
Telephone: 91-124-4715555 Fax: 91-124-4715599

A&D Instruments Canada

6695 Millcreek Drive, Unit 6, Mississauga, ON L5N 5R8, Canada
Telephone: [1](905) 814-6350 Fax: [1](905) 814-6355