

**AD-4412-CW**  
**AD-4413-CW**





**INSTRUCTION MANUAL**

---

**Weighing Indicator**

## WARNING DEFINITIONS

The warnings described in this manual have the following meanings:

 WARNING	A potentially hazardous situation which, if not avoided, could result in death or serious injury.
 CAUTION	A potentially hazardous situation which, if not avoided, may result in minor or moderate injury or damage to the instrument.
	This symbol indicates caution against electrical shock. Do not touch the part where the symbol is placed.
	This symbol indicates the ground terminal.
	This symbol indicates that an operation is prohibited.
<b>Note</b>	Information or cautions to use the device correctly.

© 2019 A&D Company, Limited. All rights reserved.

No part of this publication may be reproduced, transmitted, transcribed, or translated into any language in any form by any means without the written permission of A&D Company, Limited.

The contents of this manual and the specifications of the instrument covered by this manual are subject to change for improvement without notice.

Windows is registered trademarks of Microsoft Corporation.

Modbus protocol is registered trademarks of Modicon Inc.

Other trademarks and trade names are those of their respective owners.

# Contents

1.	Introduction .....	9
1.1.	Features .....	9
1.2.	Safety Precautions .....	10
1.3.	Compliance .....	11
2.	Parts Names.....	12
2.1.	Front Panel.....	12
2.2.	Rear Panel .....	13
3.	Installing the Weighing Indicator.....	14
3.1.	USB Flash Drive .....	14
3.1.1.	Connecting USB Flash Drive .....	14
3.1.2.	Removing USB Flash Drive .....	14
3.2.	Installing Option board.....	15
3.3.	Mounting the Weighing Indicator on Panel.....	15
3.3.1.	Panel Mount Kit ( AD-4412-10 ).....	16
3.3.2.	Attachment Kit ( AD-4412-11 ) for Indicator Stand ( AD-4402-25 ) .....	17
3.4.	Connecting Load Cell Cables.....	18
3.5.	Connecting Power Lines .....	19
4.	Operation Window .....	20
4.1.	Icon .....	20
4.2.	Numerical Input.....	20
4.3.	Pull Down Menu .....	21
4.4.	IP Address.....	21
4.5.	Alphanumeric Input .....	22
4.6.	Password Input.....	22
5.	Basic Operations.....	23
5.1.	Operation Outline.....	23
5.2.	Turning on the Power .....	24
5.3.	Turning off the Power .....	24
5.4.	Weighing Operations.....	25
5.4.1.	Changing the Indication of weighing Value .....	25
5.4.2.	Adjusting Zero point (to Display Zero) .....	26
5.4.3.	Starting and Stopping the Weighing Operation .....	26
5.5.	Managing User level for Logging in.....	27
5.5.1.	Management level of User .....	27
5.5.2.	Changing User .....	28
5.5.3.	Registering User .....	29
5.5.4.	Changing User Information .....	30
5.5.5.	Deleting User.....	31
5.6.	Selection of Products and Detection Function.....	33
5.6.1.	Registering Products .....	33
5.6.2.	Settings of Threshold Values ( Target, HiHi Limit, Hi Limit, Lo Limit, LoLo Limit ).....	35
5.6.3.	Setting Product Length and Velocity.....	36
5.6.4.	Setting the Digital Output (DO) .....	37
5.6.5.	Setting the Delay Time and Holding Time .....	38

5.6.6.	DO Test Function .....	39
5.6.7.	Setting a Tare Value .....	39
5.6.8.	The Selection of Weighing Product .....	40
5.6.9.	The Registration of Product Image .....	40
5.6.10.	Creating a Copy of Product Settings .....	41
5.6.11.	Deleting Product Settings .....	42
5.7.	Summary of Weighing Result .....	43
5.7.1.	Weighing History .....	43
5.7.2.	All Summary .....	44
5.7.3.	OK Summary .....	44
5.7.4.	Number of Samples Summary .....	45
5.7.5.	Number of OK Samples Summary .....	46
5.7.6.	Histogram .....	47
5.7.7.	$\bar{X}$ Control Chart .....	48
5.7.8.	<i>R</i> Control Chart .....	49
6.	Adjustment Operations for the Indicator .....	50
6.1.	Calibrating the Indicator using a Weight .....	50
6.2.	Settings for Date and Time .....	52
6.3.	Setting up LAN interface .....	53
7.	Output of Weighing Results and Summary .....	54
7.1.	Output to USB Flash Drive .....	54
7.1.1.	Output of Weighing History .....	54
7.1.2.	Example: Output File of Weighing History .....	55
7.1.3.	PDF output of Histogram, Control Chart and Summary .....	56
7.2.	Output to the Postscript Printer .....	57
7.2.1.	Output to Postscript Printer .....	57
7.2.2.	Printing Sample of Histogram .....	58
7.2.3.	Print Sample of Control Chart .....	59
7.2.4.	Print Sample of Summary .....	60
7.3.	Output to the Dump Printer .....	61
7.3.1.	Output to the Dump Printer .....	61
7.3.2.	Print Samples .....	62
8.	Peripherals .....	66
8.1.	Format of USB Flash Drive .....	66
8.2.	Connecting the LAN interface .....	67
8.2.1.	How to Connect to Network Using Wired LAN .....	67
8.2.2.	How to Connect to Network Using Wireless LAN .....	67
8.3.	Connecting the PostScript Printer .....	68
8.4.	Remote Monitor .....	68
8.5.	Replacing Product Using Serial Communication .....	69
9.	The Details of Settings .....	70
9.1.	Product Name and Product Code .....	74
9.1.1.	Product Name .....	74
9.1.2.	Product Code .....	74
9.2.	Detect Basis .....	74
9.2.1.	Reject Stage ( Count of Separation ) .....	74

9.2.2.	Target .....	74
9.2.3.	HiHi Limit.....	74
9.2.4.	Hi Limit .....	74
9.2.5.	Lo Limit .....	75
9.2.6.	LoLo Limit.....	75
9.2.7.	Over Weight Exception.....	75
9.2.8.	Consecutive Fail Stop.....	75
9.2.9.	Consecutive Fail Num .....	75
9.3.	Detect Parameter .....	76
9.3.1.	Product Length.....	76
9.3.2.	Speed .....	76
9.3.3.	Weighing Mode .....	76
9.3.4.	Conveyor Stop Timer.....	76
9.3.5.	Product Detection .....	77
9.3.6.	Near Zero Range.....	77
9.3.7.	Auto Mode ( to Set Parameters).....	77
9.4.	DO Map (Digital Output Map).....	78
9.4.1.	DO Map Reference .....	78
9.4.2.	Output Definition of DO Map.....	78
9.5.	Control I/O (Part of Digital Output).....	81
9.5.1.	DO Behavior.....	81
9.5.2.	Delay Time .....	81
9.5.3.	Hold Time .....	81
9.5.4.	Polarity.....	81
9.6.	Statistics .....	82
9.6.1.	Num of Samples .....	82
9.6.2.	Sub Samples.....	82
9.6.3.	$\bar{X}$ .....	82
9.6.4.	$\bar{R}$ .....	82
9.6.5.	Width of Section .....	82
9.7.	Tare.....	83
9.8.	Auto Zero.....	83
9.8.1.	Auto Zero Range .....	83
9.8.2.	Dead Zone Timer .....	83
9.8.3.	Observation Timer .....	84
9.8.4.	Averaging Time .....	84
9.8.5.	Auto Zero Sample.....	84
9.8.6.	Coe (Coefficient).....	84
9.9.	D. Comp. Value.....	84
9.10.	Feedback Control (FC).....	85
9.10.1.	Feedback Control Target .....	86
9.10.2.	Feedback Control Range .....	86
9.10.3.	Feedback Control Step : [g/sec.] or [sec./g] .....	86
9.10.4.	Feedback Control Sample .....	86
9.10.5.	Feedback Control Waiting Time.....	86
9.11.	Step Control .....	87
9.11.1.	Control Target.....	87
9.11.2.	Zone 1 to 4 of 10 Stage Control.....	88

9.11.3.	10 C Sample .....	88
9.11.4.	10 C Wait Time.....	88
9.12.	Weighing .....	89
9.12.1.	Unit.....	89
9.12.2.	Decimal Point.....	89
9.12.3.	Division .....	89
9.12.4.	Capacity.....	89
9.12.5.	Digital Filter.....	89
9.12.6.	Zero Point Range.....	89
9.12.7.	Power on Auto Zero Range.....	89
9.12.8.	Zero Tracking Time .....	90
9.12.9.	Zero Tracking Weight.....	90
9.12.10.	Stability Time .....	90
9.12.11.	Stability Weight.....	90
9.13.	Cal (Calibration) .....	91
9.13.1.	Weight.....	91
9.13.2.	Zero Point.....	91
9.13.3.	Span.....	91
9.14.	Main Unit .....	92
9.14.1.	Identification Name .....	92
9.14.2.	Start up User Level .....	92
9.14.3.	Conveyor Length .....	92
9.14.4.	Unsplit Range.....	92
9.14.5.	Conveyor Mode .....	92
9.14.6.	Connect Device Priority .....	92
9.14.7.	Curb Chattering.....	93
9.14.8.	Photo Eye Sensor Polarity .....	93
9.14.9.	Photo Eye Sensor Timeout.....	93
9.14.10.	Random Check (To input data previously).....	93
9.15.	Display.....	94
9.15.1.	Language .....	94
9.15.2.	Display Mode .....	94
9.15.3.	Negative Weight.....	94
9.15.4.	Display Data .....	94
9.15.5.	Standby Mode.....	94
9.15.6.	Brightness.....	94
9.16.	Connection.....	94
9.16.1.	Printer IP Address .....	94
9.17.	DI Map (Digital Input Map).....	95
9.18.	Control I/O (Part of Digital Input).....	95
9.18.1.	Input Trigger .....	96
9.18.2.	Configuration .....	98
9.18.3.	Delay Time .....	101
9.18.4.	Chattering.....	101
9.19.	DI Indicator .....	102
9.20.	Analog Out.....	103
9.20.1.	Data Types .....	103
9.20.2.	Output Format.....	103

9.20.3.	Low Voltage Standard .....	103
9.20.4.	High Voltage Standard.....	103
9.20.5.	Low Voltage Output .....	103
9.20.6.	High Voltage Output.....	103
9.20.7.	Low Current Standard .....	103
9.20.8.	High Current Standard.....	103
9.20.9.	Low Current Output .....	103
9.20.10.	High Current Output.....	103
9.21.	Device.....	104
9.21.1.	Model Name.....	104
9.21.2.	Serial Number .....	104
9.21.3.	GUI Software Version .....	104
9.21.4.	Weighing Software Version .....	104
9.21.5.	Option Port 1 and 2.....	104
9.22.	Date / Time .....	104
9.22.1.	Date Set.....	104
9.22.2.	Time Set .....	104
9.23.	USB Flash Drive .....	104
9.23.1.	USB Operation History .....	104
9.23.2.	USB Weighing History .....	104
9.24.	Modbus .....	105
9.24.1.	Modbus.....	105
9.24.2.	Slave Address .....	105
9.25.	Output Format.....	106
9.26.	RS-232C .....	108
9.26.1.	RS-232C Port.....	108
9.26.2.	Output Mode .....	108
9.26.3.	Baud Rate .....	108
9.26.4.	Parity .....	108
9.26.5.	Stop Bit .....	108
9.26.6.	Data Bit .....	109
9.27.	RS-485 .....	109
9.27.1.	RS-485 Port .....	109
9.27.2.	Output Mode .....	109
9.27.3.	Baud Rate .....	109
9.27.4.	Parity .....	109
9.27.5.	Stop Bit .....	109
9.27.6.	Data Bit .....	109
9.28.	LAN.....	110
9.28.1.	CL IP Address .....	110
9.28.2.	CL Subnet Mask .....	110
9.28.3.	CL Default Gateway.....	110
9.28.4.	WL Port.....	110
9.28.5.	WL IP Address.....	110
9.28.6.	WL Password .....	110
9.29.	Monitor.....	111
9.29.1.	RS-232C.....	111
9.29.2.	RS-485 .....	112

9.29.3.	Control I/O .....	112
9.29.4.	OP-02 Relay Output .....	113
9.29.5.	OP-05 Parallel I/O .....	113
9.29.6.	OP-07 Analog Output .....	114
10.	Modbus Communication .....	115
10.1.	Using Modbus RTU .....	116
10.2.	Using Modbus TCP .....	116
10.3.	Communication Command of Modbus .....	117
10.3.1.	Example of Reading Input Register .....	117
10.3.2.	Example of Writing Holding Register .....	118
10.3.3.	Example of Exception Response .....	119
10.4.	Reference Number .....	120
10.5.	Address .....	120
10.6.	Communication Command of Modbus TCP .....	144
10.6.1.	Protocol Layout .....	144
10.6.2.	Example of Reading Input Register .....	144
11.	Interface .....	145
11.1.	Control I/O .....	145
11.1.1.	Connection of Control I/O .....	145
11.2.	RS-232C .....	146
11.2.1.	Connection of RS-232C .....	146
11.3.	RS-485 .....	147
11.3.1.	Connection of RS-485 .....	147
11.4.	Photo Eye Sensor .....	148
11.4.1.	Connection of Photo Eye Sensor .....	148
11.5.	OP-02 Relay Output .....	148
11.6.	OP-05 Parallel Input / Output .....	150
11.7.	OP-07 Analog Output .....	152
11.7.1.	The Way to Set Output Current .....	153
11.8.	OP-17 Additional Analog Output Module .....	153
12.	Maintenance .....	154
12.1.	Error Messages of Indicator .....	154
12.1.1.	Error Message Table .....	154
12.2.	Backup of System Data .....	155
12.3.	Restoring System Data .....	156
12.4.	Initialization to Factory Settings .....	158
13.	Specifications .....	159
13.1.	Dimensions .....	160
13.1.1.	AD-4412-CW .....	160
13.1.2.	AD-4413-CW .....	161



# 1. Introduction

## 1.1. Features

### Note

- This instruction manual is described both weighing indicators of the AD-4412-CW and AD-4413-CW. Explanation of common part in this manual expediently uses the AD-4412-CW. Therefore if you use the AD-4413-CW, read and replace product name appropriately.
- The AD-4412-CW and AD-4413-CW are the indicator designed for classifying the weighing product on conveyor.
- Stainless steel is used to the front panel of the AD-4413-CW.

### Display Unit

- The indicator equips 7-inch sensitive touch screen considered with operability.
- The indicator realizes easy readability and operability using the touch screen.

### Dustproof & waterproof structure

- The indicator equips waterproof construction complying with IP65 when mounting on panel.

### Functions

- The indicator can store 1000 products (100 products for each 10 group) in maximum.
- The indicator can read picture from USB flash drive and display it on touch screen.
- User data can be stored, classified and managed properly using management level. Therefore, operator can perform with safety operation of weighing system.
- The indicator can perform serial communication and communicate with peripherals to support modbus using TCP/IP communication and no program.

### Output & input Interface

- General input, rejecter output, alarm output, RS-232C / RS-485 input / output and TCP/IP are equipped as standard model.

## 1.2. Safety Precautions

Read the following precautions to use the indicator safely before use surely.

### Caution

#### Hazard of rotating object

- Keep hands and fingers away from the rotating part while the indicator is running.
- If product has stayed on conveyor, fell over or spilled, stop the indicator immediately, turn the power off and take necessary actions.

#### Hazard of electrical shock

- Be sure to turn the power off before removing the display cover or control box cover for inspection.
- Keep the power turned off during the inspection.
- Turn the power on after the installation has been complete.

#### Precautions for installation

- Install the indicator on a solid surface away from sources of vibration.
- Install the indicator in a place that does not exposed to direct sunlight.
- Install the indicator in an area where it is not subject to direct flow from the window, electric fan or air conditioner.

#### Grounding

- Be sure to ground the indicator to avoid electrical shock, fire or malfunction.

#### Precautions for use

- Do not apply shock or excessive external force to the weighing conveyors.
- Do not apply a load exceeding the weighing capacity to the weighing conveyor.
- Do not modify or disassemble the indicator and conveyor. Do not change the parts.
- Install the weighing conveyor to horizontal level.
- Keep feeding of product with a constant interval.

#### Cooling the Indicator

- To avoid overheating of the indicator, make enough clearance from other devices. If the temperature surrounding the indicator exceeds the operating temperature range, use fan for forced cooling to the indicator so as not to effect to weighing.

## 1.3. Compliance

### Adaptation for local laws

The indicator has been tested and complies with Subpart J of Part 15 of FCC rules.  
(FCC = Federal Communications Commission in the U.S.A.)

The indicator equips a licensed wireless communication unit used 2.4 GHz band that specifies 2AC7Z-ESPWROOM02 to FCC ID. This license area is Japan and U.S.A. If you use other area, ask concerning of approval to local authority.

### Cautions of wireless LAN (WiFi)

If the communication function of this scale is used near a wireless device that communicates in the 2.4 GHz range, the processing speed of both devices may decrease.

The wireless band using the scale is used by microwave oven, industry, science, medical device, mobile identifier in factory and licensed radio station and radio station of no license.

- Confirm that there is no these radio stations and mobile identifier around the weighing indicator.
- If radio interference by the indicator is occurred to radio station of mobile identifier, change the frequency or stop transmission of radio wave. (Example: Use of partition. Installation to other place etc.)

#### **2.4 DS 4**

- 2.4 : Wireless equipment of 2.4 GHz band.
- DS : Modulation method is direct-sequence spread spectrum (DS-SS).
- 4 : The distance to occur radio interference is 4 m or shorter.
- — — : The whole range is used and it cannot avoid band of mobile identifier.

## 2. Parts Names

This section is described for name of each part.

### 2.1. Front Panel

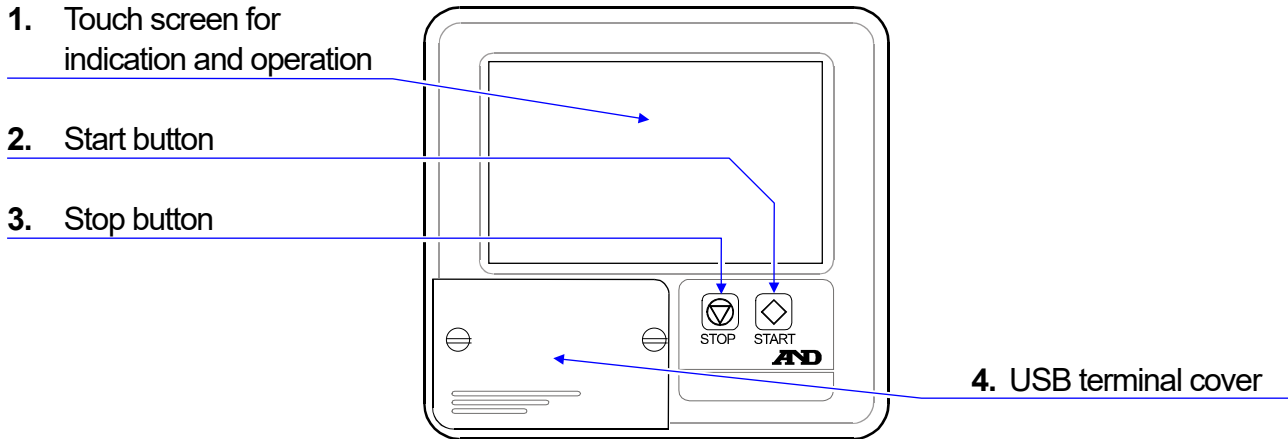

Drawing 1 Front panel of AD-4412-CW

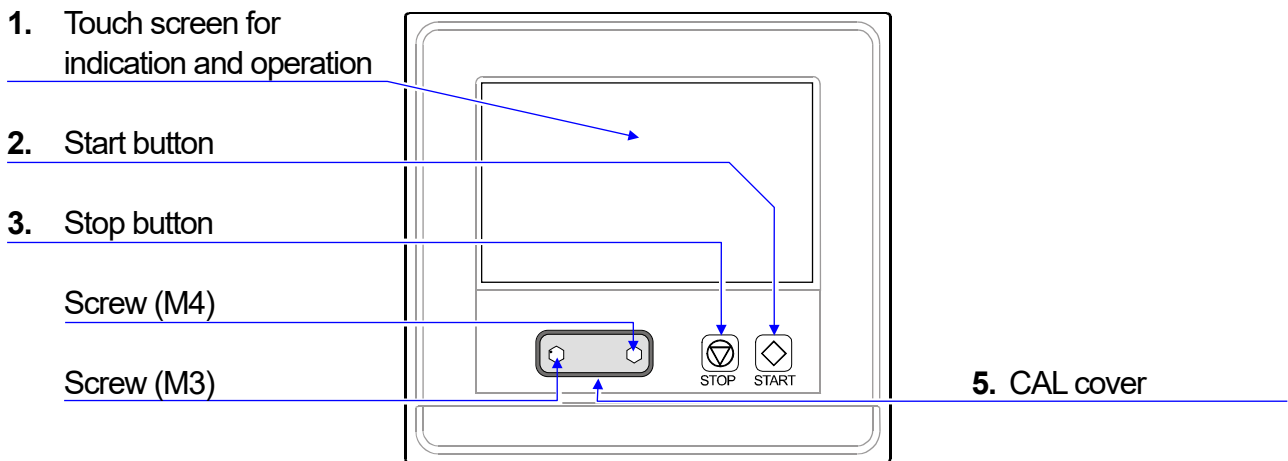

Drawing 2 Front panel of AD-4413-CW

Table 1 Names and functions of front panel

No.	Name	Description and Function
1.	Touch screen	The indication and settings of weighing can be displayed and operated.
2.	Start button	Weighing can start and conveyor can run.
3.	Stop button	Weighing and conveyor can stop.
4.	USB terminal cover	Waterproof cover for the USB terminal. A USB terminal is equipped on AD-4412-CW.
5.	CAL cover	The cover to prevent unnecessary operation of the calibration switch on AD-4413-CW.

## 2.2. Rear Panel

1. Optional ports

6. I/F terminals

3. Input terminals of load cell

7. Power switch

4. RS-232C

8. Power cord terminals

5. Control I/O

9. LAN connector

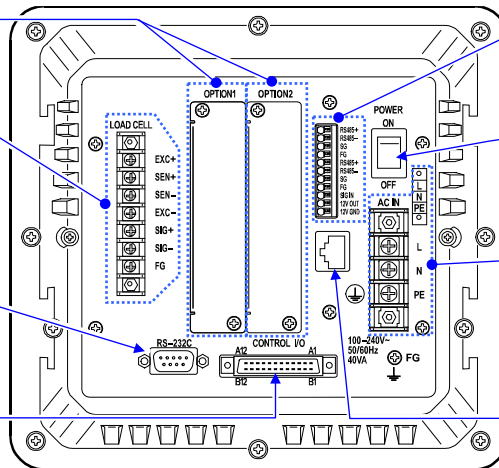

Drawing 3 Rear panel of AD-4412-CW

1. Optional ports

6. I/F terminals

2. USB terminal

7. Power switch

3. Input terminals of load cell

8. Power cord terminals

4. RS-232C

9. LAN connector

5. Control I/O

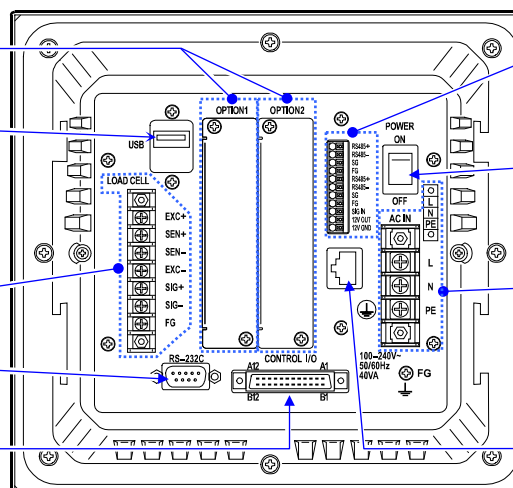

Drawing 4 Rear panel of AD-4413-CW

Table 2 Names and functions of rear panel

No.	Name	Description and Function
1.	Optional ports	Two optional boards can be installed in maximum.
2.	USB terminal	Terminal to connect USB device on AD-4413-CW.
3.	Input terminals of load cells	Four 350 Ω load cells can be connected in maximum.
4.	RS-232C	It is used to communicate printer, barcode reader and computer.
5.	Control I/O	It is used to control peripherals. Input : 11 points. Output : 11 points.
6.	I/F terminals	RS-485 and photo eye sensor terminals. It is used for stream mode and communication with PLC using Modbus RTU. It uses as power source of photo eye sensor.
7.	Power switch	It is the main power supply switch for the indicator.
8.	Power cord terminals	Power supply range : 100-240 V ~
9.	LAN connector	It is used communication using Modbus TCP and a PDF output to the printer on network.

## 3. Installing the Weighing Indicator

Procedures of installing the indicator and connecting power line are described in this chapter.

### 3.1. USB Flash Drive

#### 3.1.1. Connecting USB Flash Drive

The terminal are used when product image data is registered and output data is stored into USB flash drive.

If you use USB flash drive, open the cover and connect USB flash drive to the USB terminal. When USB flash drive is identified by the indicator, USB mark is displayed at right-upper side of the screen.



#### Caution

Use USB flash drive formatted in FAT32.

If USB flash drive of other format is used, format it in FAT32 before use.

If USB mark is not displayed after connecting USB flash drive, it may be incompatible to file system of operation system.

USB memory means USB flash drive.

Refer to "[8.1 Format of USB Flash Drive](#)" and format USB flash drive.

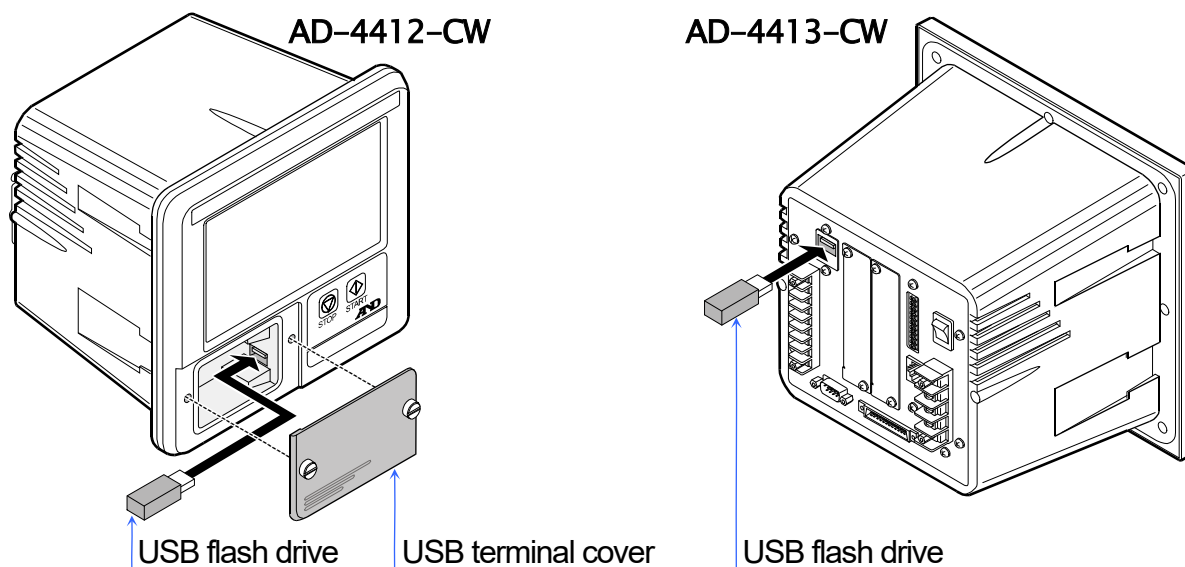

Drawing 5 USB Flash Drive

#### 3.1.2. Removing USB Flash Drive

#### Caution

If USB flash drive is removed using method without the following procedure, it may cause a failure concerning storing data file.

Step 1. Press and hold the USB mark at right-upper side of the screen when removing USB flash drive.



Step 2. After the USB mark hides, remove the USB flash drive.

## 3.2. Installing Option board

- In first, install the option board. Next, operate them.
- An option board can install to an arbitrary slot of either two slots.

### Danger

Turn off power switch and remove power lines when removing cover of option board.

### Warning

Do not touch the inside of the indicator immediately after turning off the power. It may cause catch electrical shock. Wait for 10 seconds and operate them.

### Caution

Fix screws securely and do not leave loosen screw. If a loosen screw is left, electrical circuit may short during use. It may cause malfunction due to noise.

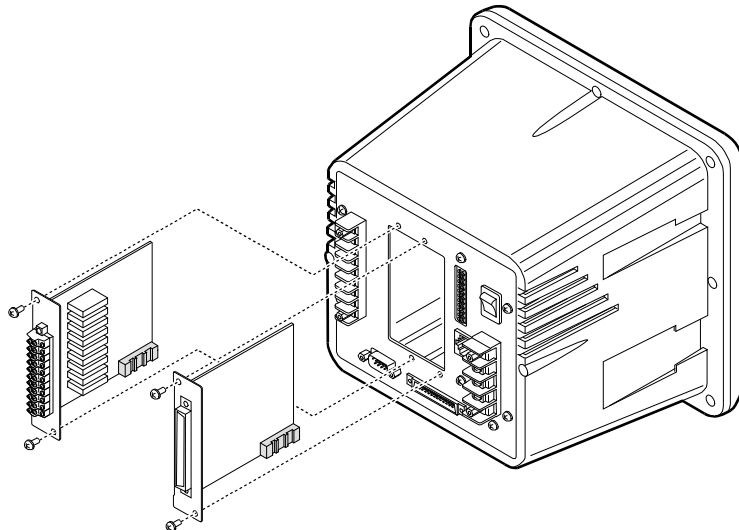

Drawing 6 Installing option bard

## 3.3. Mounting the Weighing Indicator on Panel

- The installation of the indicator is the panel mounting using slide rails. When sealing gasket for the panel mounting is used, the front panel is waterproof structure complied with IP-65.

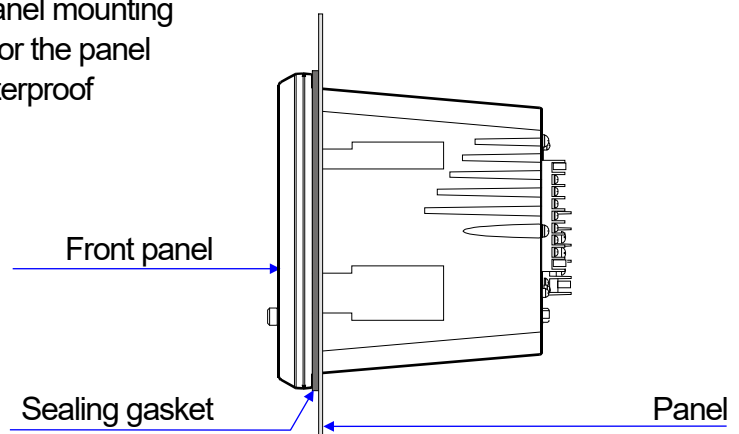

Drawing 7 Mounting weighing indicator on panel

### 3.3.1. Panel Mount Kit (AD-4412-10)

- Step 1. Attach the sealing gasket to the indicator with its correct direction.
- Step 2. Mount the indicator on the panel so as not to be kinked sealing gasket.
- Step 3. Slide attachment parts on trenches of both side. Fix the indicator using attachment parts and screws (two M4x12) to be able to protect from water.
- Step 4. Check the installation.

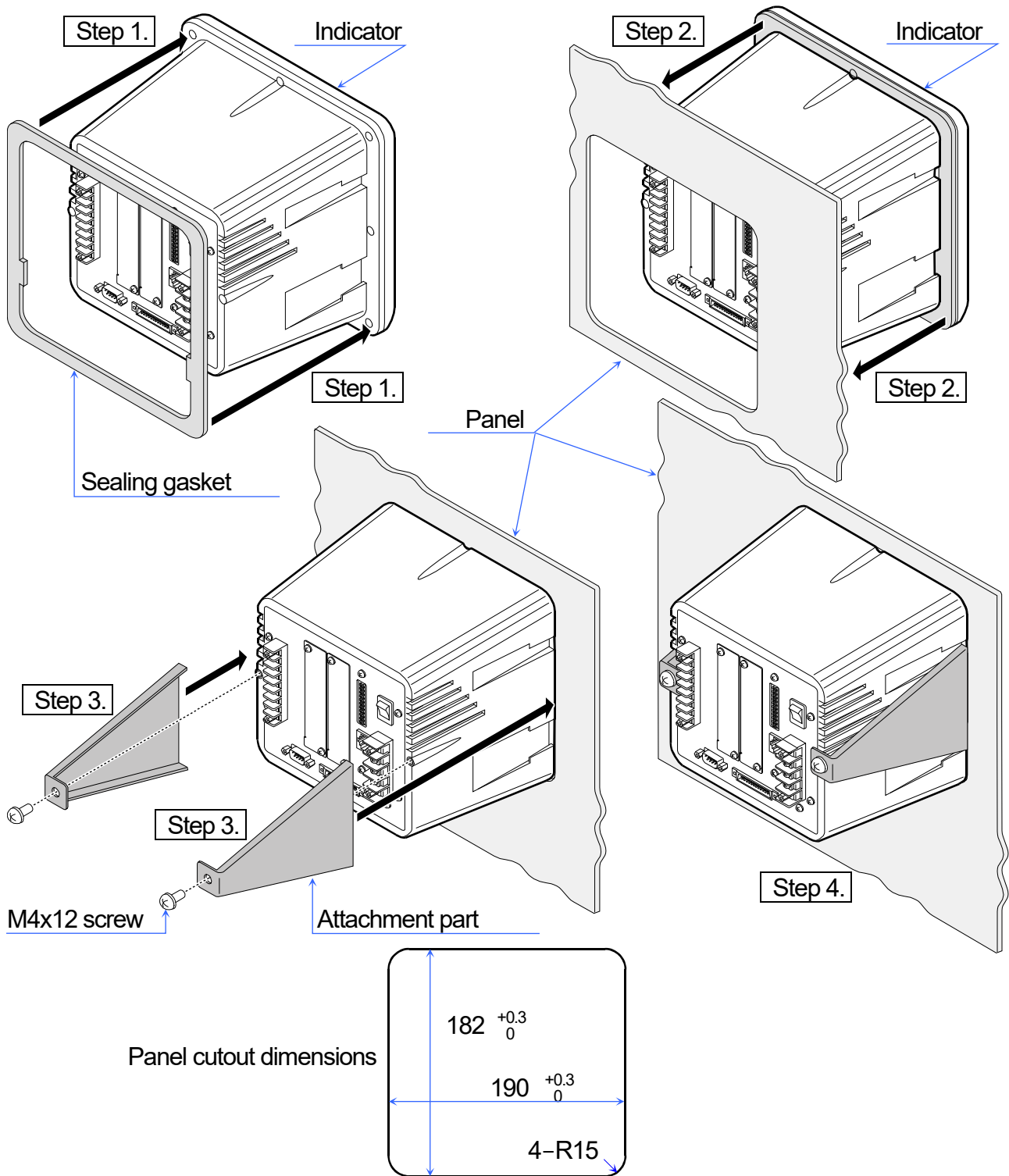

Drawing 8 Panel Mount Kit (AD-4412-10)



### 3.3.2. Attachment Kit (AD-4412-11) for Indicator Stand (AD-4402-25)

- Step 1. Remove two M3x8 screws and two M4x15 screws on the rear panel on the indicator.
- Step 2. Attach guide plates on the rear panel.  
Interpose guide plates between the rear panel and screws of step 1.  
Fix these screws and guide plates.
- Step 3. Slide the indicator along slide rails on the indicator stand.
- Step 4. Fix the indicator using two M4x8 screws included in accessory of attachment kit.
- Step 5. The angle of the indicator can arrange using two knobs.

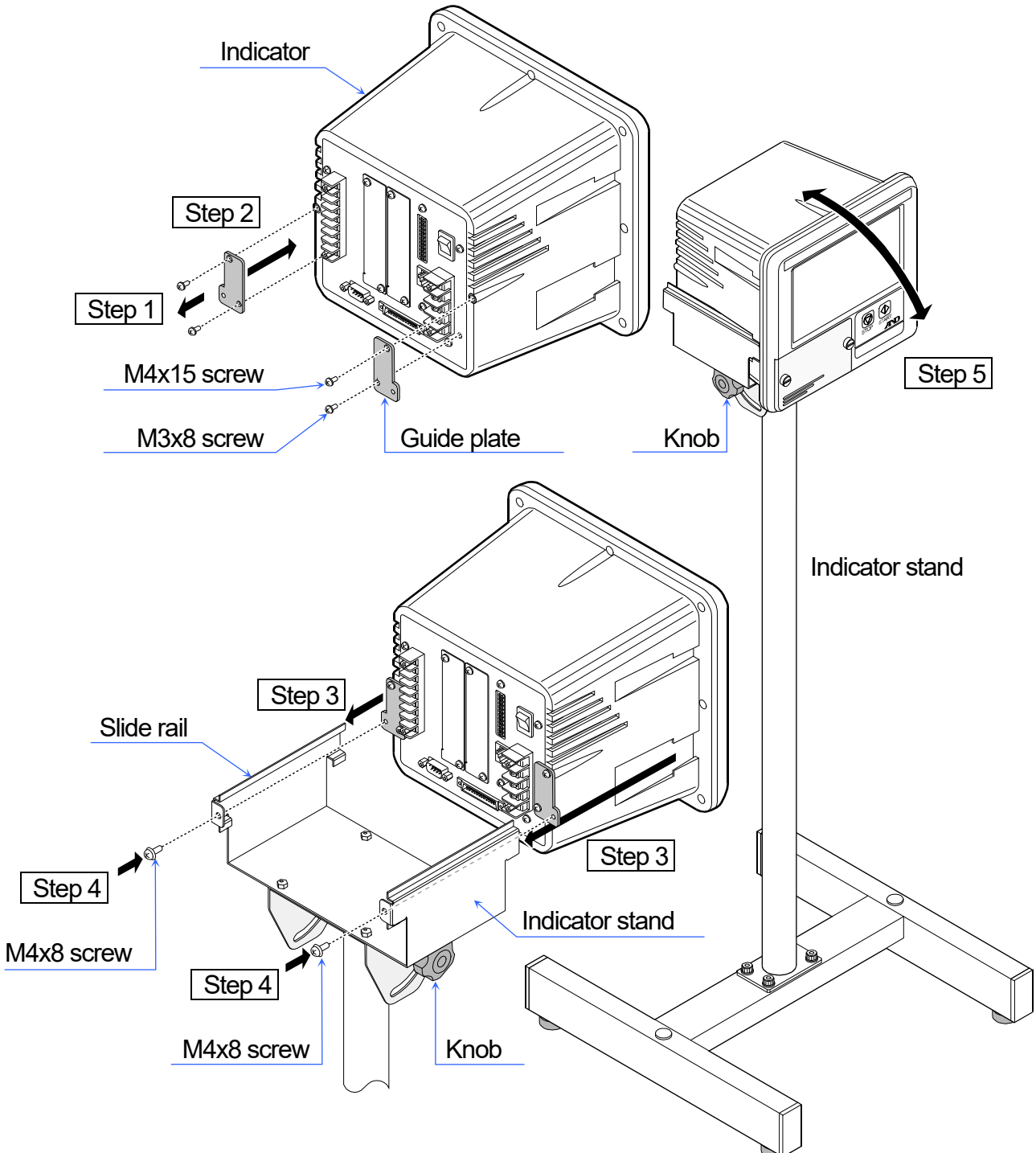

Drawing 9 Panel Mount Kit (AD-4412-11)

### 3.4. Connecting Load Cell Cables

- We recommend that you use the 6-wire shielded cable to prevent loss of weighing precision. If long load cell cables or summing box is used, use 6-wire shielded cable to prevent drift of weighing value due to temperature change. The 4-wire shielded cable (that is shorted EXC+ & SEN+ and shorted EXC- & SEN-) is able to use, but it may cause weighing error when the summing box is used for plural load cells or long cable is used.

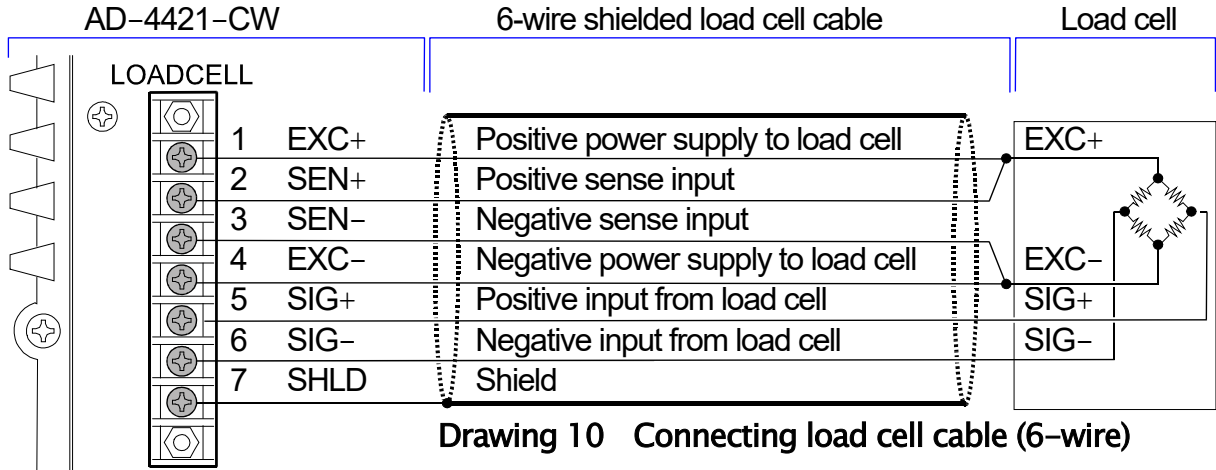

#### Compensating Voltage Output at Zero Point

- When the zero calibration is performed, if the output voltage of the load cell at the zero point is too large (the message "CERR2" is displayed) and it is too small (the message "CERR3" is displayed), the output voltage can be adjusted by adding a correction resistor as Drawing 11. Use the correction resistor of low (good) temperature coefficient.

##### In Case of Too Large Offset of Zero Point

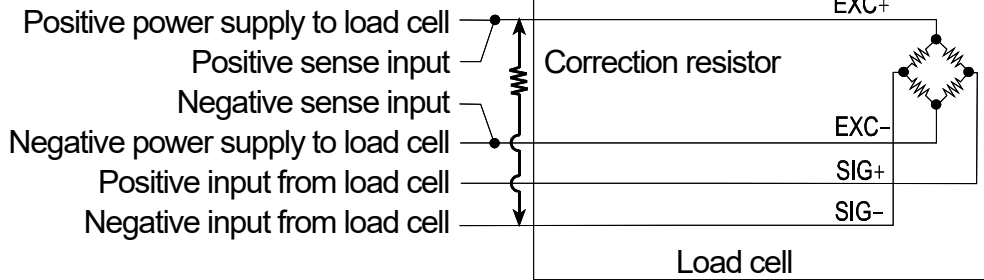

##### In Case of Too Small Offset of Zero Point

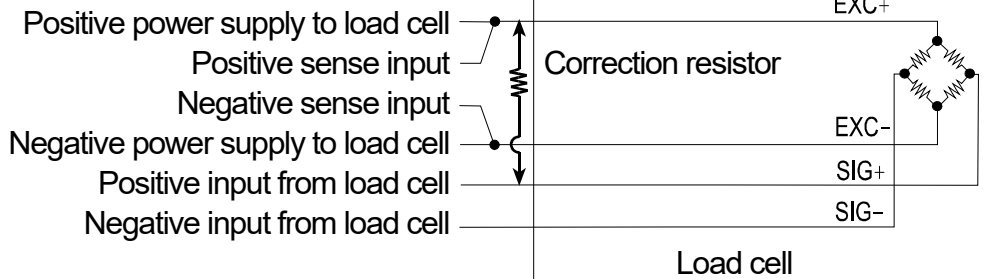

**Drawing 11 Adjusting voltage output at zero point**

#### Adaptable Compression Terminal Parts (M3)



### 3.5. Connecting Power Lines

The Indicator can connect to power line of 100-240 V ~ .

Do not share the power cord with an electric power device to avoid operation errors.

Ground the indicator certainly.

Do not use an unstable power source.

Do not share the ground wire with an electrical device that generates noise.

#### Warning

Ground the indicator to avoid an electric shock or operation error. If the indicator is not grounded, it may cause an electric shock or malfunction due to discharge of static electricity.

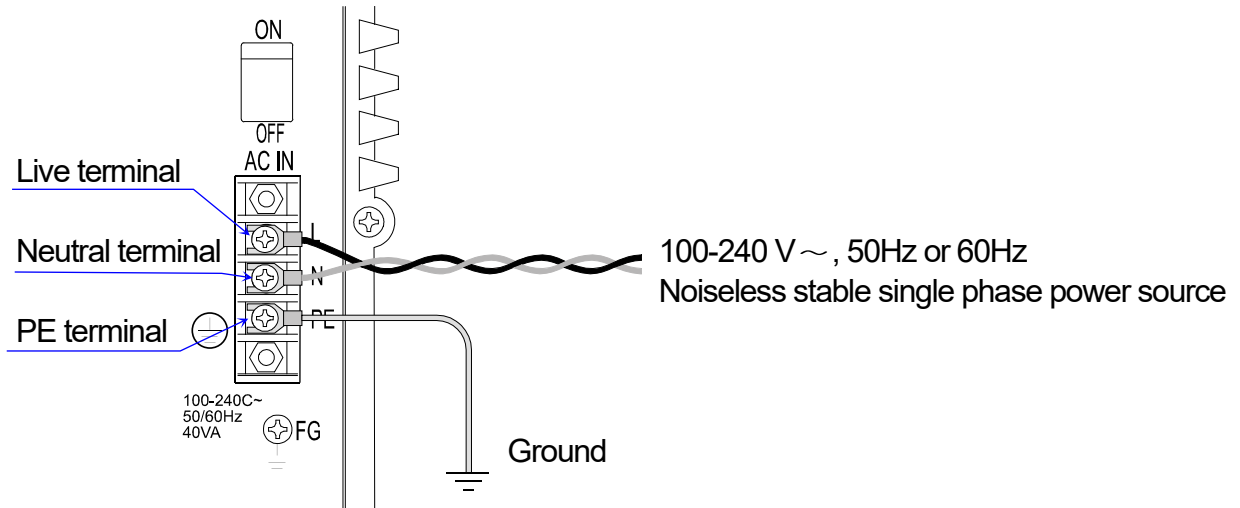

Drawing 12 Connecting Power Lines

#### Adaptable Compression Terminal Parts (M4)









## 4. Operation Window

Basic operations of the touch screen equipped in the indicator is described in this chapter.

### 4.1. Icon

This section describes the function of the common icon.  
Other icons describes at each operation.

Icon	Name	Description and Function
	Home key	The key to return to weighing display.
	Return key	The key to back to last window. If you touch the key plural times, the indicator backs to weighing display.
	Left arrow key	The key to move the cursor position of product selection, setting menu and plural pages on the display.
	Right arrow key	
	Up arrow key	
	Down arrow key	

### 4.2. Numerical Input

When numerical input is performed, the numerical dialog box is displayed.

1. The "BS" key to delete a numeric character input last. The cursor proceeds back one character.
2. The "CLR" key to delete all numeric characters.
3. When the "ESC" key is touched, the current input value is canceled and the dialog box is closed.
4. When the "ENT" key is touched, the current input value is stored and the dialog box is closed. If an input value is out of range, it does not stored.

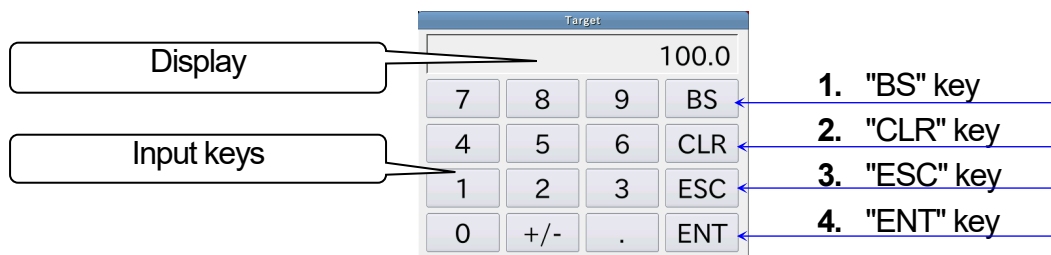

Drawing 13 The numerical dialog box

### 4.3. Pull Down Menu

When an item selection is required, the pulldown selection dialog box appears.

1. Select an item and touch the "OK" key. The selected item is confirmed.



Drawing 14 Pulldown selection dialog box

### 4.4. IP Address

The IP address dialog box is displayed when it is necessary to specify the IP address of the indicator and network printer. Input numeric value after opening the IP address dialog box.

1. The "BS" key to delete a numeric character input last. The cursor proceeds back one character.
2. The "CLR" key to delete all numeric characters.
3. When the "ESC" key is touched, the current input value is canceled and the dialog box is closed.
4. When the "ENT" key is touched after inputting IP address, the current input value is stored and the dialog box is closed.



Drawing 15 IP Address dialog box

## 4.5. Alphanumeric Input

The alphanumeric dialog box is displayed when it is necessary to input characters.

1. The alphanumeric dialog box can input alphabet of small caps and numeric characters.
2. The "MODE" key to exchange dialog box of alphabet and numeric characters.
3. The "BS" key to delete a numeric character input last. The cursor proceeds back one character.
4. The "CLR" key to delete all numeric characters.
5. When the "ESC" key is touched, the current input value is canceled and the dialog box is closed.
6. When the "ENT" key is touched, the current input value is stored and the dialog box is closed.

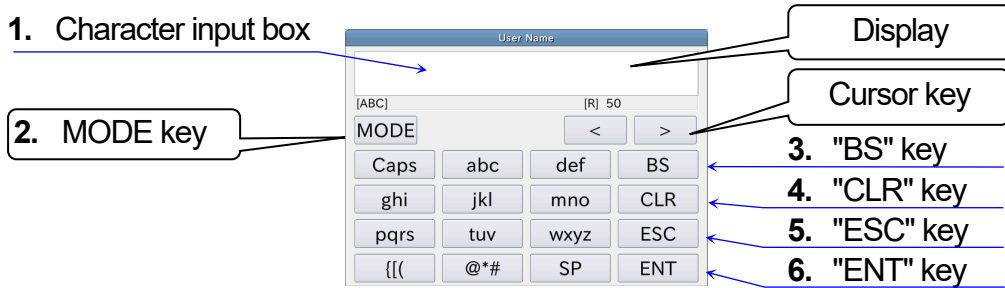

**Drawing 16 Uppercase letters**



**Drawing 17 Numerical letters**

## 4.6. Password Input

The password dialog box is displayed at login window and registration of user password.

1. The "BS" key to delete a numeric character input last. The cursor proceeds back one character.
2. The "CLR" key to delete all numeric characters.
3. When the "ESC" key is touched, the current input value is canceled and the dialog box is closed.
4. When the "ENT" key is touched, the current input value is stored and the dialog box is closed. The input password is displayed as "\*" characters.

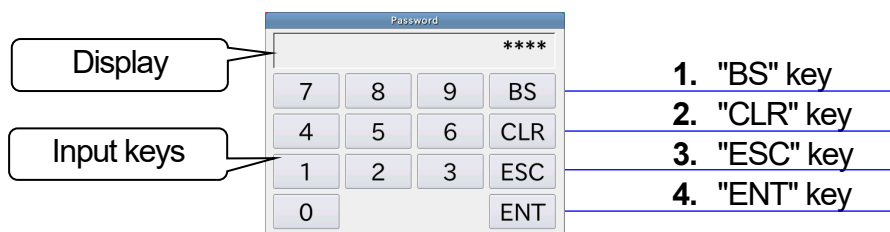

**Drawing 18 Password input dialog box**

# 5. Basic Operations

## 5.1. Operation Outline

The outline of weighing procedure and operations are described in this chapter.

An ordinary weighing operation is as follows : Refer to chapters after "5.2.Turning on the Power" in accordance with the following flowchart.

- \*1 Refer to "5.5. Managing User level for Logging in" if you need to register a user. Administrator user "Admin" is registered in factory settings.

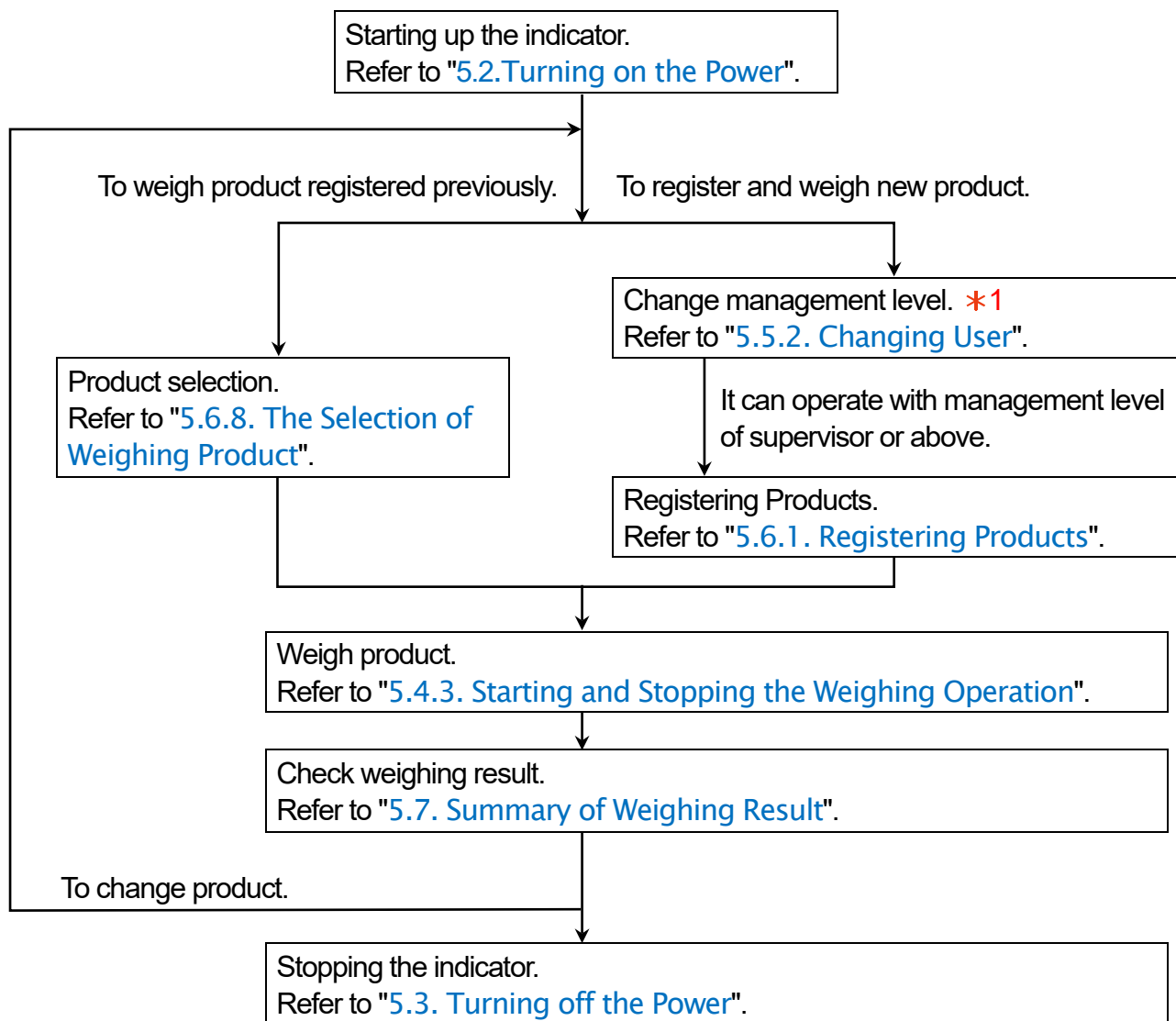

## 5.2. Turning on the Power

Step 1. Turn on the indicator when power switch turns to "ON".

Step 2. The weighing mode is displayed after turning on.

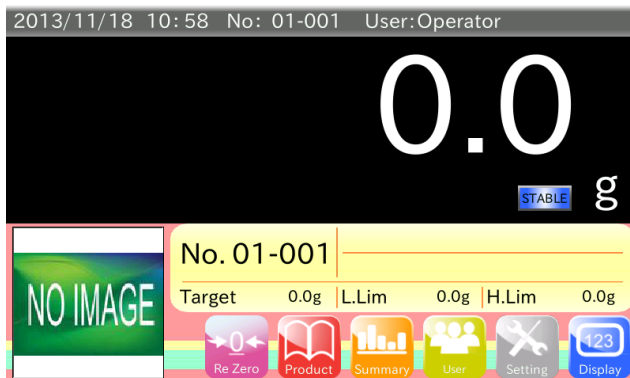

Drawing 19 Weighing window (Initial setting)

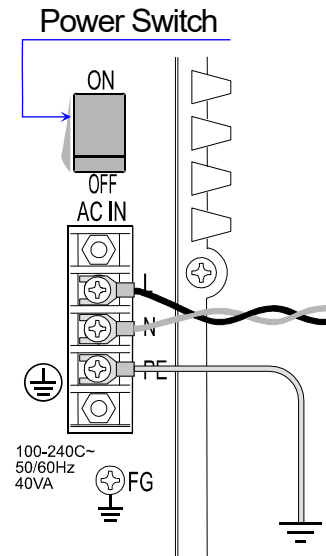

## 5.3. Turning off the Power

Step 1. When turning off power switch to "OFF", the indicator is stopped.

### Caution

- For emergency stop, perform the above operation. In that case, before turning the power ON again, be sure to resolve the cause of the stop.

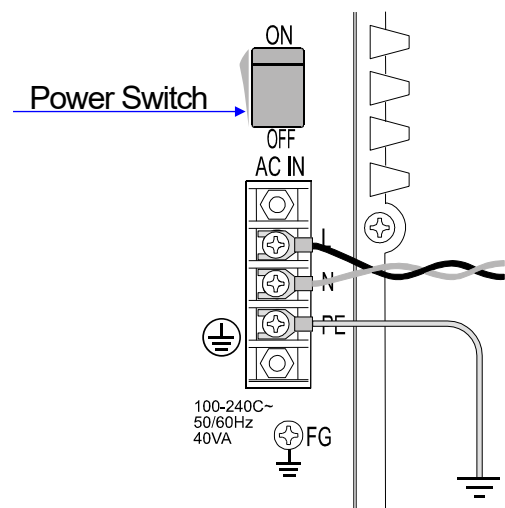



## 5.4. Weighing Operations

Weighing operations are described in this chapter.

### Note

- The description of this section assumes that the product has been registered and set beforehand.
- For details about the product registration and setting, refer to "5.6. Selection of Products and Detection Function".

### 5.4.1. Changing the Indication of weighing Value

Touch the "Display" key  on the weighing screen to change the displaying size and contents of the weighing values. The contents are two types : Regular display and display with deviation. Both display can be enlarged and reduced.

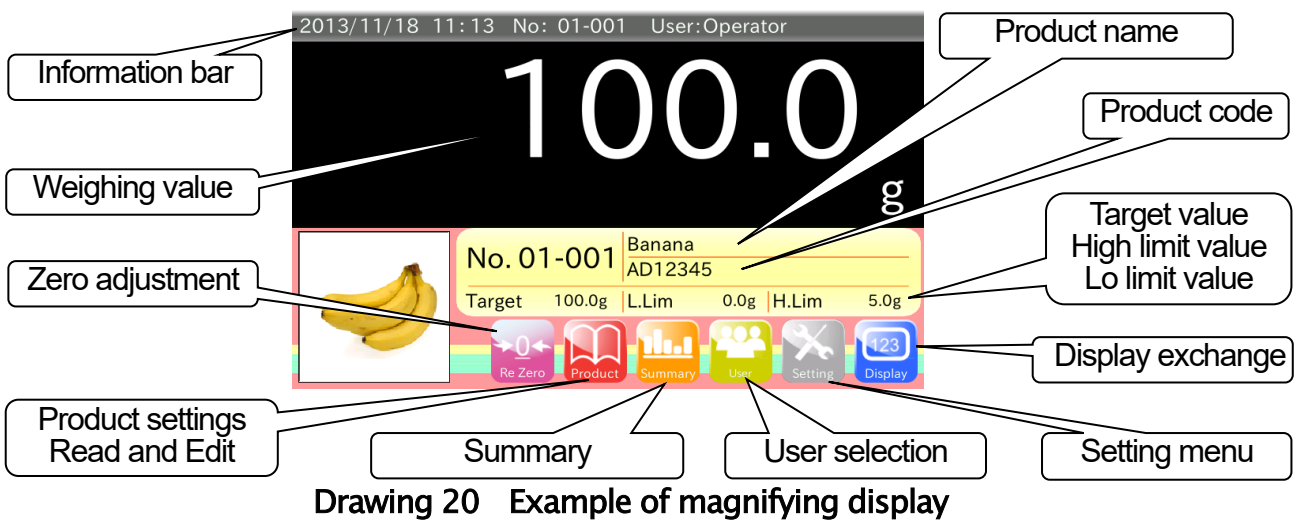

The "regular display" shows the current weighing value. If a tare value is set, net value is displayed. The "display with deviation" shows a standard value and deviation of weighing value of product. The mark  is displayed in "display with deviation".

The display sequence of the "Display" key  is as follows :

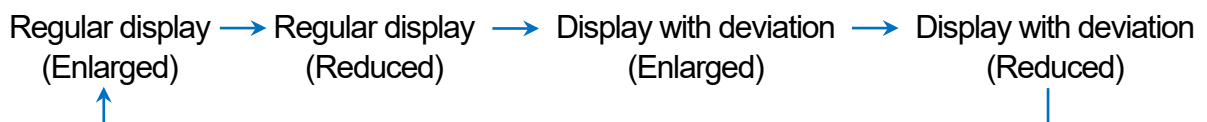

## 5.4.2. Adjusting Zero point (to Display Zero)

---

If the weighing value is not zero (0) when the conveyor is stopped, touch the "Re-Zero" key  to perform zero adjustment to set the weighing value to zero.

When the weighing value exceeds the zero adjustment range when the conveyor is stopped, zero adjustment cannot be performed.

Causes of the above situation are as follows :

- There may be foreign substances on the conveyor.
- Foreign substances are collected on the conveyor little by little. Accordingly, zero adjustment is performed each time. Now the mass value of the collected foreign substances may exceed the zero adjustment range.
- The weighing conveyor may be contacted with the infeed conveyor or reject conveyor.
- An excessive load is applied to the conveyor and the load cell is deformed.
- An upward excessive load is applied to the load cell and the load cell is deformed.

For example : To hold and rise up the conveyor.

If the weighing value is not zero even if the foreign substances are removed and zero adjustment is performed, calibrate the indicator using a weight.

When the load cell is deformed within the usable range, the calibration using a weight will set the weighing value to zero.

If the weighing value is not zero even if the calibration using a weight, replace the weighing conveyor unit.

### Note

- Refer to "[6.1. Calibration the Indicator using a Weight](#)" for the details about the calibration using a weight".

## 5.4.3. Starting and Stopping the Weighing Operation

---

Press the START button on the front panel to move the conveyor to start a weighing operation.

Press the STOP button on the front panel to stop the conveyor to finish a weighing operation.

## 5.5. Managing User level for Logging in

This indicator can register user and limit available operations in accordance with user level for management. In this chapter, the way of editing user data, managing user level and entering in the mode are described.

### Cautions

- User name "**Admin**", Password "**0000**" and management level "Administrator" are registered as default user.
- "Administrator" is required to edit user data.  
Log in as "Administrator" to edit new user unregistered.

### Note

- This management mode can perform "registration", "change" and "deletion" of user.
- This management mode can change user level to arbitrary level for management.  
Refer to "[9.14.2. Start up User Level](#)".

### 5.5.1. Management level of User

The indicator has four levels for management : "Administrator", "Supervisor", "Quality Manager" and "Operator". Refer to "**Table 3 Difference between management levels**" for details. Assign an appropriate user level for each user so as to avoid unintentional operations and be able to use the indicator safely. Management level is set "Operator" when turning on the indicator.

### Cautions

- "Operator" of management level means that is not more than "Quality Manager".  
"Operator" cannot perform "registration", "change" and "deletion" of user.

Table 3 **Difference between management levels**

Management level	Description
Operator	Starting weighing or stopping operation, display of summary and operation of selecting weighing product.
Supervisor	In addition to operations of "Operator", product settings and deletion of summary data.
Quality Manager	In addition to operations of "Supervisor", the whole system operations.
Administrator	In addition to operations of "Quality Manager", operations of user management.

## 5.5.2. Changing User

Management level is set "Operator" when turning on the indicator. It is required to log in with authorized management user when changing user.

The way to logging in with authorized management user shown below.

### Caution

- User name "**Admin**", Password "**0000**" and management level "Administrator" are registered as default user.

Step 1. Touch the "User" key  on the weighing screen to display "Login window".

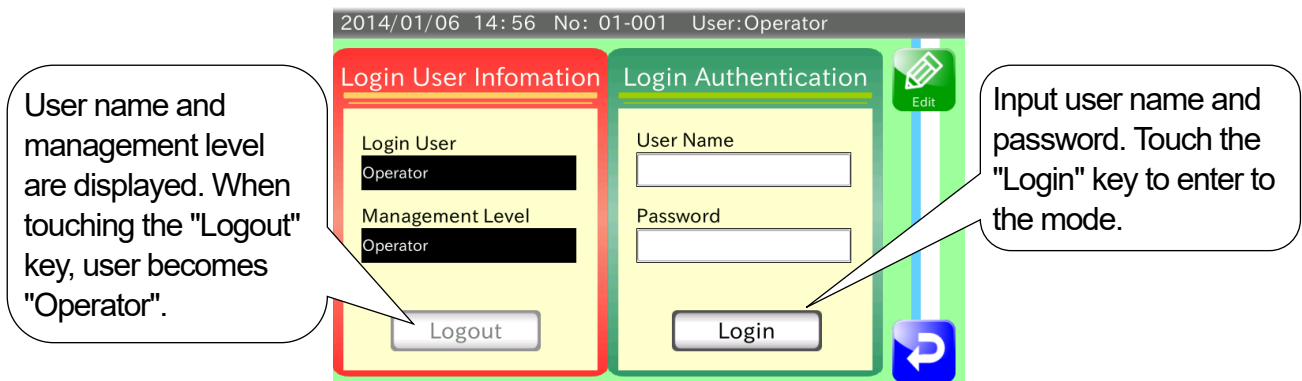

**Drawing 22. Login window**

Step 2. Input user name and password registered previously.

Step 3. Touch the "Login" key after inputting them.

Step 4. Touch the "Return" key  to proceed to the weighing mode.

### 5.5.3. Registering User

The procedure to register user is shown below.

Step 1. Touch the "Edit" key  to display "User edition window".

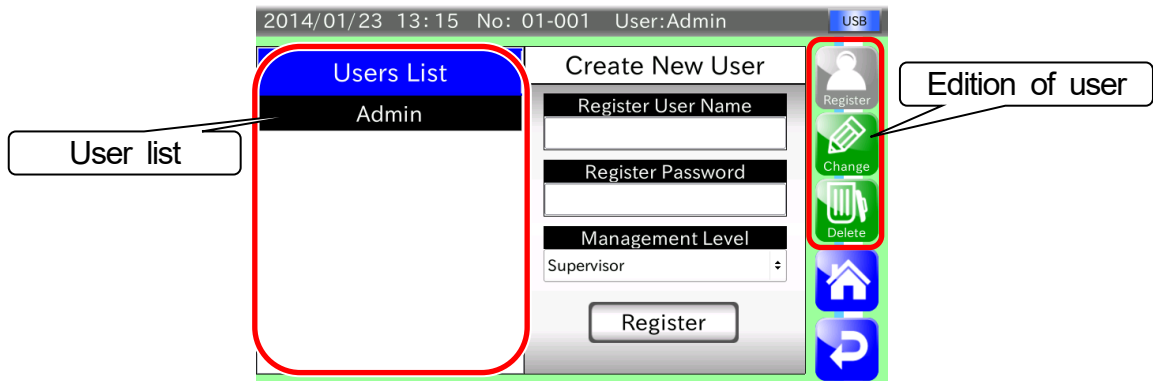

Drawing 23 User edition window

Step 2. Select a user name from user list and input user name.

Step 3. Input password. Password is four characters.

Step 4. Select a management level.

Management level is "Administrator", "Supervisor", "Quality Manager" and "Operator".

Step 5. Touch the "Register" key to display it in user list.

Step 6. Touch the "Return" key  to return the "Login window".

## 5.5.4. Changing User Information

The content of registered user can be changed using this user management mode.  
The procedure of changing user data is shown below.

Step 1. Display the "User edition window".

Step 2. Touch the "Edit" key  to display "User information window".

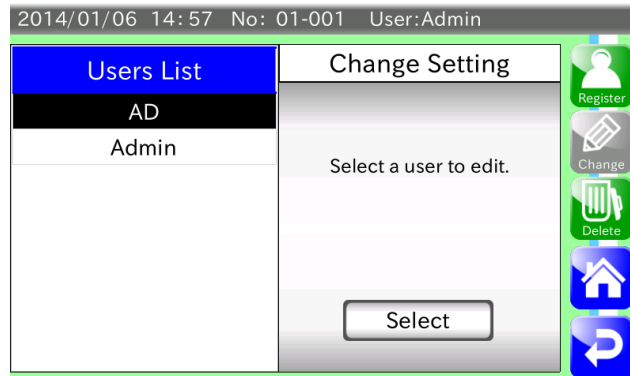

Drawing 24 User information window

Step 3. Select a user to change the data from user list.

Touch the "Select" key to display "Window to change user information".

Touch the "Right arrow" key  to return "User information window".

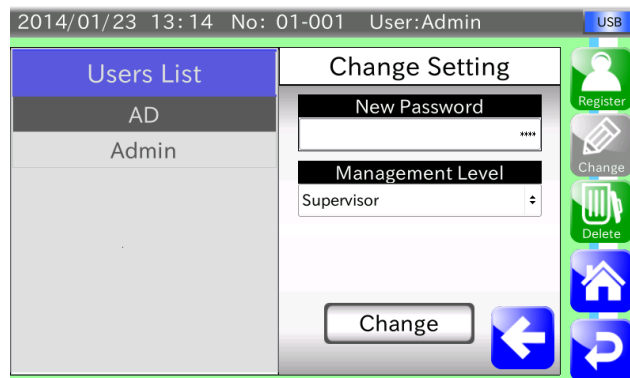

Drawing 25 Window to change user information

Step 4. Select password. Input new password of four characters.

Step 5. Select management level.

Step 6. Touch the "Change" key  to store them.

## 5.5.5. Deleting User

The user can be deleted using the user management mode.

There are two types for deletion : The way to delete a specified user and all registered users.

The procedure to delete user is shown below.

### Caution

- Default user "**Admin**" cannot be deleted.
- The current user logged in cannot be deleted.
- If user except default user "**Admin**" is logged in and all user are deleted, user is set to "Operator" automatically.

Step 1. Display the "**User edition window**".

Step 2. Touch the "Delete" key  to display the "**Window to delete user**".

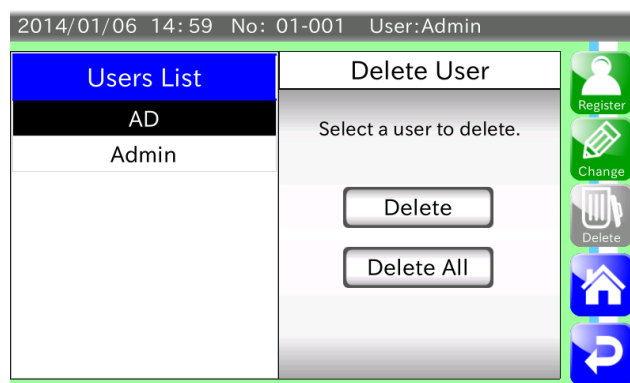

Drawing 26 Window to delete user

### Deleting Specified User

Step 1. If specified user is deleted, select a name from user list of the "**Window to delete user**".

Step 2. Touch the "Delete" key  to display the following "**Dialog box to confirm deletion**".  
Touch the "YES" key to delete user.

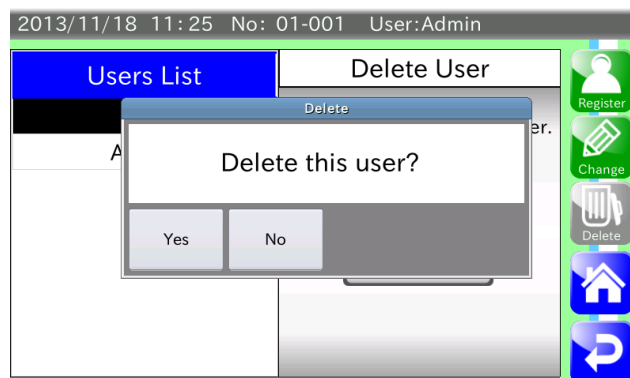

Drawing 27 Dialog box to confirm deletion

Step 3. A specified user is disappeared from user list.

### Deleting all user

Step 1. Touch the "All delete" key to display the "**Dialog box to confirm deletion**".

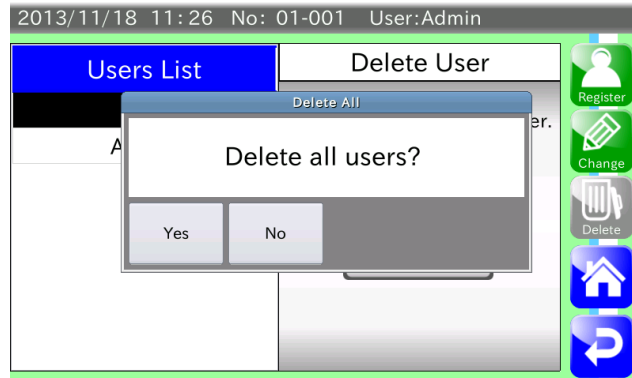

**Drawing 28** Dialog box to confirm deletion

Step 2. Touch the "YES" key to delete all user except "**Admin**".



## 5.6. Selection of Products and Detection Function

This chapter describes for the changing procedure of product selection and detection function required for weighing. If it is necessary to register product, log in "Quality Manager" or greater user in advance.

This chapter assumes that user is "Quality Manager" or greater user.

### Note

Refer to "9. The Details of Settings" concerning of other settings except settings of this chapter. The settings are stored for each changing it during the procedure.



If the "Return" key  is touched during the procedure, previous window is displayed.

### 5.6.1. Registering Products

The procedure to register product is shown below.

Step 1. Touch the "Product" key  on the "Weighing window" to display the "Window to select product."

Step 2. Input group number (Selection range : 1 to 10).

The registration page can switch using the "Left arrow" key  and "Right arrow" key . Touch the product number to register. When product number is touched, the cell changes orange and product can be edited. Product number can be edited directly, too.

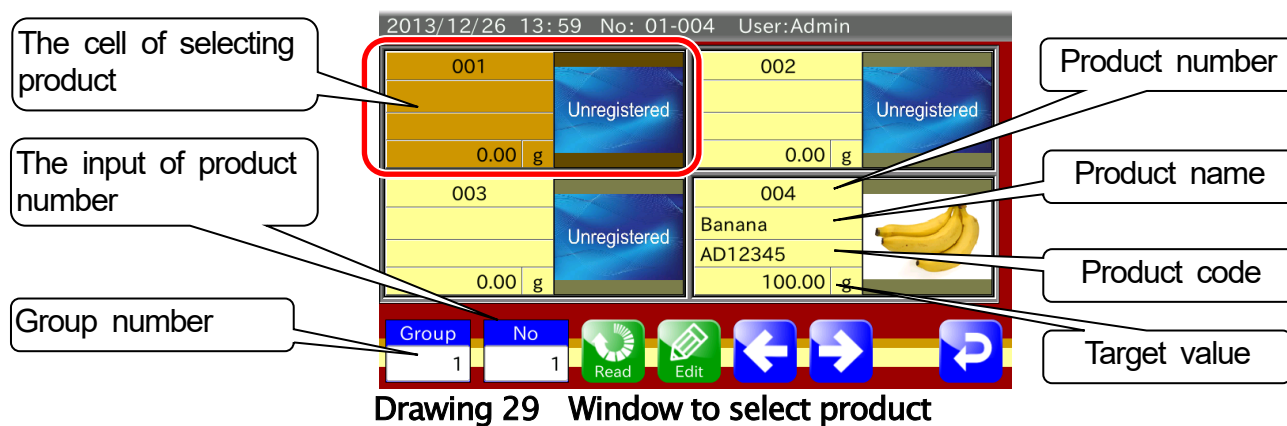

Step 3. Touch the "Edit" key  to register the product. "Product profile window" is displayed. In the window, product name, code, image can be edited and the settings can be copied or deleted.

**Note**

- ❑ The "Image" key can register product image stored in USB flash drive. Refer to "5.6.9. The Registration of Product Image".
- ❑ The "Copy" key can copy registered product settings previously to the current product number. Refer to "5.6.10. Creating a Copy of Product Settings".
- ❑ The "Delete" key can delete a registered product settings. Refer to "5.6.11. Deleting Product Settings".

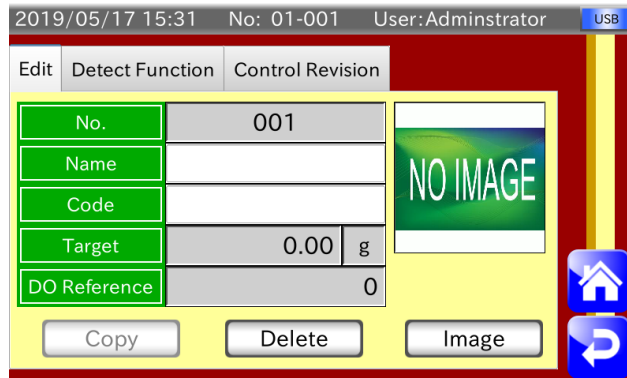

**Drawing 30 Product profile window (Edit tab)**

- Step 4. Touch the "Detect function" tab to display the product profile window. The settings of each product can edit in the product profile window. Refer to "5.6.2. Settings of Threshold Values ( Target, HiHi Limit, Hi Limit, Lo Limit, LoLo Limit )" and below.

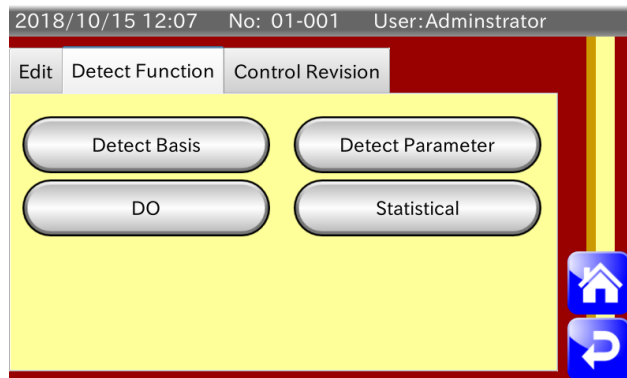

**Drawing 31 Product profile window ( Detect function tab)**

## 5.6.2. Settings of Threshold Values ( Target, HiHi Limit, Hi Limit, Lo Limit, LoLo Limit )

Standard values for detection can be specified in the "Window of threshold values".

- Step 1. Touch the "Detect basis" key in the "Detect function" tab to display the "Window of threshold values".

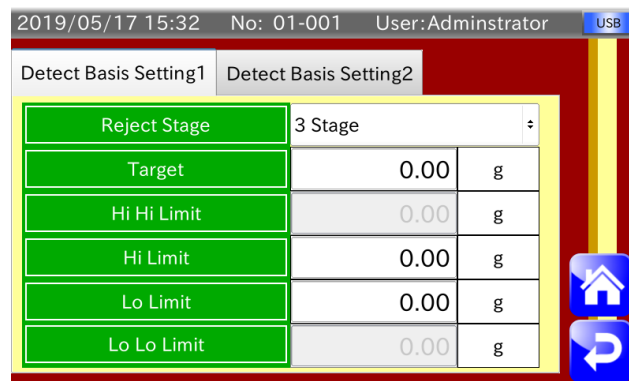

Drawing 32 Window of threshold values

- Step 2. Select separation number either the three stages or the five stages.
- Step 3. Touch the "Target" item and input mass value of target product.
- Step 4. Touch the "Hi limit" item and input Hi limit mass value of product.  
It is deviation value from target value. Input it smaller than HiHi limit value.  
Example : If target value is 100 g and tolerance value of upper side is 150 g,  
Hi limit value is 50 g.  
 $50 \text{ g} = 150 \text{ g} - 100 \text{ g}$
- Step 5. When the five stage separation is used, touch the "HiHi limit" item and input HiHi limit value.  
It is deviation value from target value. Input it bigger than Hi limit value.
- Step 6. Touch the "Lo limit" item and input Lo limit mass value of product.  
It is deviation value from target value. Input it bigger than LoLo limit value.  
Example : If target value is 100 g and tolerance value of lower side is 50 g,  
Lo limit value is 50 g.  
 $50 \text{ g} = 100 \text{ g} - 50 \text{ g}$
- Step 7. When the five stage separation is used, touch the "LoLo limit" item and input LoLo limit value. It is deviation value from target value. Input it smaller than Lo limit value.
- Step 8. Touch the "Return" key  to display the "Product profile window".

### 5.6.3. Setting Product Length and Velocity

The procedure to specify the processing performance is shown below.

- Step 1. Touch the "Detect parameter" key in the "Detect Function" tab to display the "Window to set product length and velocity".
- Step 2. Touch the "Product length" item and input product length.
- Step 3. Touch the "Speed" item and input velocity of the conveyer.
- Step 4. Touch the "Return" key  to display the "Product profile window".

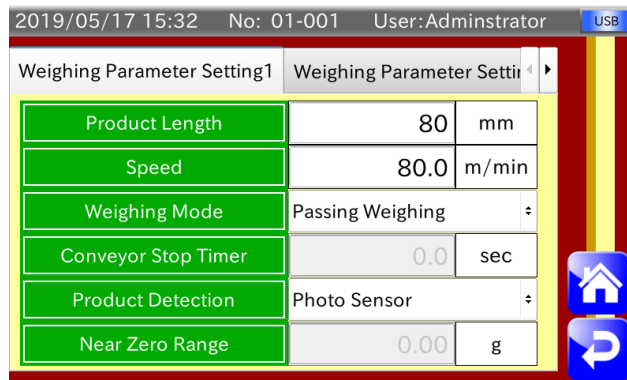

Drawing 33 Window to set product length and velocity

## 5.6.4. Setting the Digital Output (DO)

The procedure to specify the settings for each product concerning of stopping conveyor and DO (Digital Output) is shown below.

### Note

- Refer to "9.4. DO Map" for details of DO.

Step 1. Touch the "DO" key "Detect function" tab to display "DO setting window".  
Touch the "DO" key to display "Setting window of DO map".

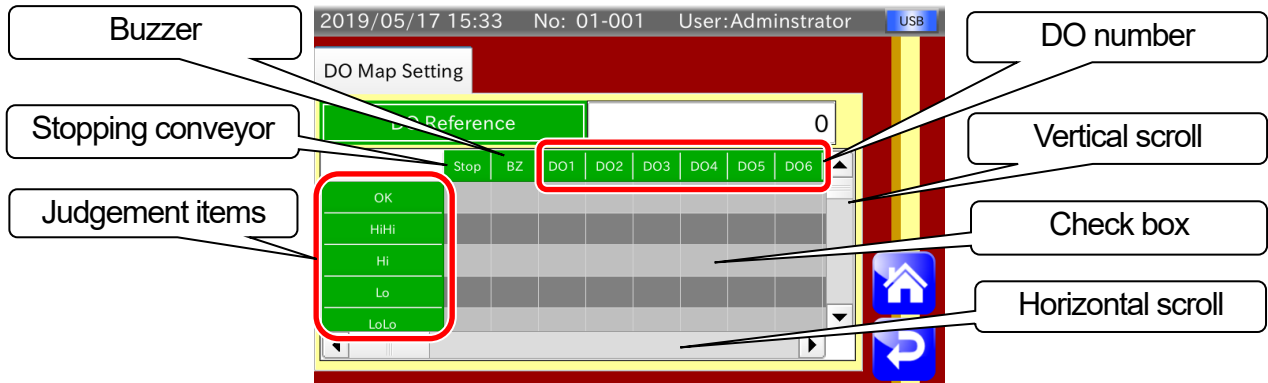

Drawing 34 Setting window of DO map

Step 2. Touch each check box to make check so that outputs each judgement. Items of judgement can be changes using vertical scroll bar. DO number can be changed using horizontal scroll bar.

Example : If judgement is "over" and you want to output a signal from DO1, touch to check box with white line. Then, check mark  is appeared.

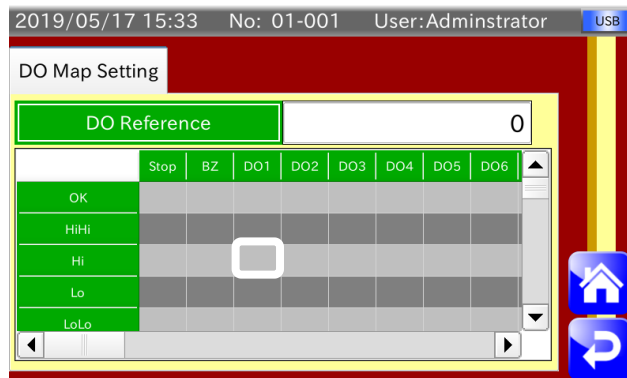

Drawing 35 Check window of DO map

Step 3. When product is weighed and is output judgement, DO outputs in accordance with settings of delay time and signal holding time of separator.

### Note

- Refer to "5.6.5. Setting the Delay Time and Holding Time" for delay time and signal holding time.

Step 4. If check mark exists in "Stop" item and applicable judgement is output, the conveyor stops.

Step 5. If check mark exists in "BZ" item and applicable judgement is output, buzzer sounds.

Step 6. Touch the "Return" key  to display the "DO setting window".

## 5.6.5. Setting the Delay Time and Holding Time

### Note

- Refer to "9.5. Control I/O". DO Action" for delay time and signal holding time.

The procedure of settings for DO behavior after judgement is shown below.

Delay time means time from judgement to output.

Signal holding time means time to maintain DO output signal.

- Step 1. Touch the "Control I/O" key on "DO setting" tab to display "The DO setting window".  
Judgement item can be changed using "Tab".

- Step 2. Touch DO and input delay time for each DO.

Example : In case that rejecter of flipper type is used.

Set the delay time that is transportation time from judgement at the end of the weighing conveyor to be fed to the rejecter. At this time, consider swing time of rejection flipper.

If distance from weighing conveyor to rejecter is 0.2 m,  
conveyor velocity is 30 m/min. and swing time of rejecter is 0.3 sec.,  
delay time is 0.1 sec =  $0.2 \text{ m} \div 30 \text{ m/min} \times 60 \text{ sec.} - 0.3 \text{ sec.}$

Additionally, swing time of the rejecter depends on the air cylinder cushion needle setting. Therefore, so further fine adjustment is required.

If a comparator light is connected, we recommend to shorten delay time and increase hold time for visual confirmation.

- Step 3. Touch the holding time and input it for each DO.

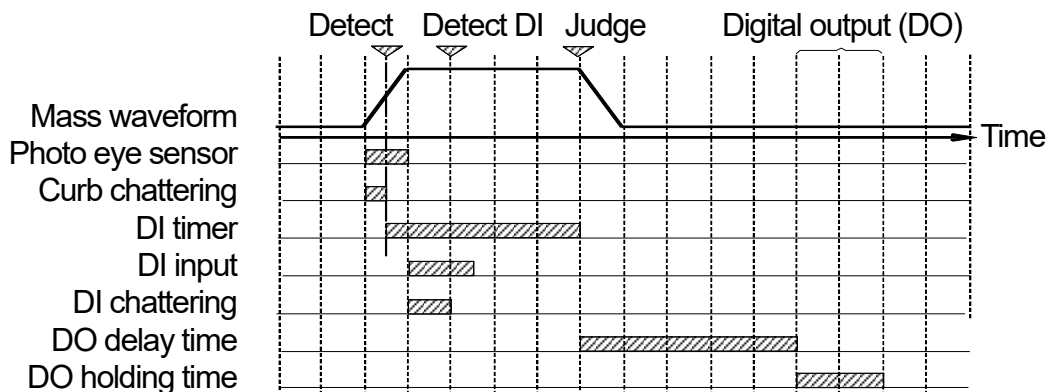

Drawing 36 Timing chart of DI/DO (Digital input / Digital output)

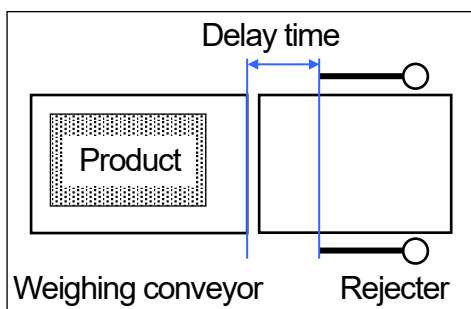

Drawing 37 Example of delay time

2018/09/14 07:06 No: ----- User: Administrator

BZ - DO3 DO4 - 7 DO8 - 11

	Time	Positive Logic
Buzzer	0.00 sec	0.00 sec
DO1	0.00 sec	0.00 sec
DO2	0.00 sec	0.00 sec
DO3	0.00 sec	0.00 sec

Drawing 38 The DO setting window

### 5.6.6. DO Test Function

The DO behavior function can use to DO test output.  
Touch DO number in "DO test function window" to test it.

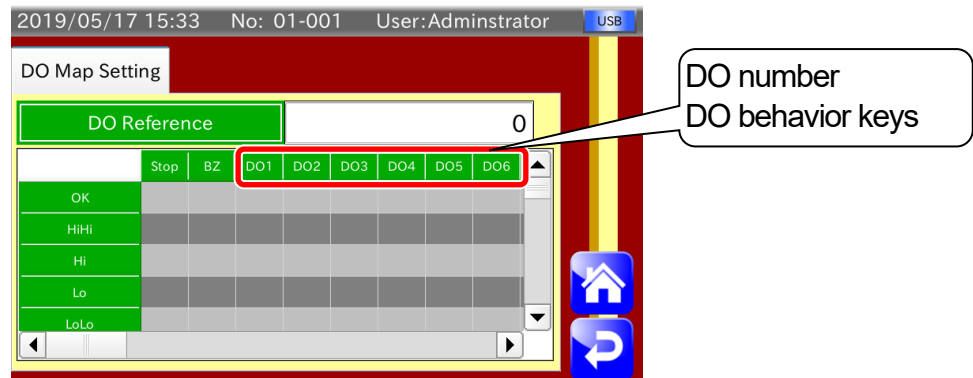

Drawing 39 DO test function window (Example : DO1, DO2)

### 5.6.7. Setting a Tare Value

Tare value can be set the following window.





- Step 1. Touch the "TARE" key on "Compensation Setting" Tab to display the window of Drawing 40.
- Step 2. Input a tare value. If it is necessary to cancel tare value, input "0.00" to tare value.  
When tare value stored in the indicator is deleted, tare value is set to "0.00".  
Tare mark **Tare** is displayed while tare value is used.
- Step 3. Touch the "Return" key  to display "Product profile window".



Drawing 40 The setting window of tare value

## 5.6.8. The Selection of Weighing Product

The procedure to select a weighing product.

- Step 1. Touch the "Product" key  on the "Weighing window" to display the "Window to select product".
- Step 2. Input a group number (Range: 1 to 10).  
The registration page can change using the "Left arrow" key  and "Right arrow" key . Touch the product number to select it. Then, the area of selected product becomes orange. Additionally, a product number can be input directly.
- Step 3. If the "Read" key  on the "Window to select product" is touched, the settings of the selected product is input.  
Otherwise, if the "START" button is pressed while displaying the "Window to select product", the "Window profile product" and each function windows, the product data can be read.

### Caution

If a selected product is same as the weighing product, the change of the product using the "START" button cannot use.

- Step 4. Touch the "Return" key  to display "Product profile window".

## 5.6.9. The Registration of Product Image

The procedure to store the product image.

### Caution

- Store product image in USB flash drive beforehand.
- The file name including space character cannot register.
- The file extension of registrable image file is ".jpg" JPEG file.

### Note

- Refer to the "[3.1.1. Connecting USB Flash Drive](#)" to connect the USB flash drive.
- Refer to the "[8.1. Format of USB Flash Drive](#)" to format the USB flash drive.
- Refer to the "[3.1.2. Removing USB Flash Drive](#)" to remove the USB flash drive.

- Step 1. Display the "Edit" tab on the "Product profile window".



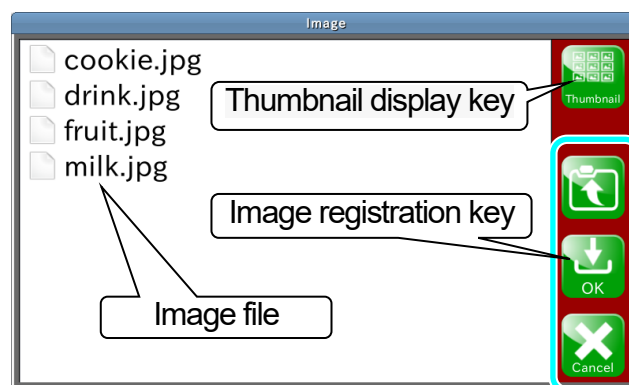

- Step 2. Connect the USB flash drive to the indicator.

- Step 3. Touch the "Image" key to display the "Image selection window".



Drawing 41 Image selection window



- Step 4. Touch the holder name to open it. If you want to move to parent directory, touch the "Return" key . If you want to finish image selection, touch the "Cancel" key . If you want to display thumbnail, touch the "Thumbnail display" key .
- Step 5. Touch the image file name to select it.
- Step 6. Touch the "OK" key . Then, the image is registered and display to "Edit" tab on the "Product profile window".

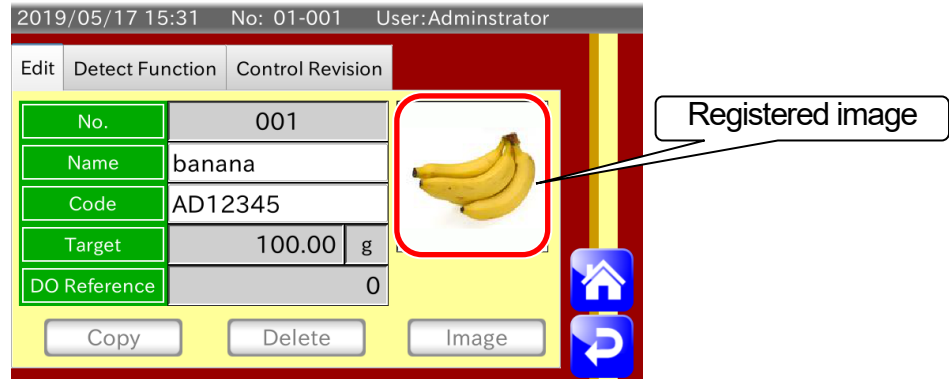

Drawing 42 Example to store product image

### 5.6.10. Creating a Copy of Product Settings

The procedure to copy the product settings.

If you want to use the product settings to another product, you can create a copy of the product settings with this procedure. This procedure is shown below.

- Step 1. Display the "Edit" tab on the "Product profile window".
- Step 2. Touch the "Copy" key.
- Step 3. The dialog box to copy the product settings is displayed.

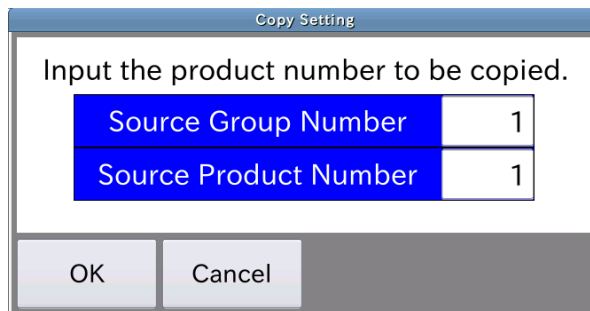

Drawing 43 Dialog box to create a copy of product settings

- Step 4. Select a source group number and input it.
- Step 5. Select a source product number and input it.
- Step 6. Touch the "OK" key.
- Step 7. The specified product settings is copied.

#### Caution

- Do not copy the product settings that is specified as source DO reference.

## 5.6.11. Deleting Product Settings

---

The procedure to delete the product settings.

The procedure is shown below.

- Step 1. Display the **"Edit"** tab on the **"Product profile window"**.
- Step 2. Touch the **"Delete"** key.
- Step 3. The dialog box to delete the product settings is displayed.  
If you want to delete it, touch the **"OK"** key.

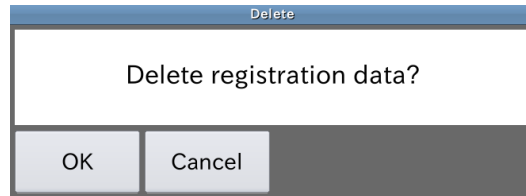

**Drawing 44** Dialog box to delete product settings

- Step 4. The product settings is deleted and becomes unregistered.

### Caution

- Do not copy the product settings that is specified as source DO reference.

## 5.7. Summary of Weighing Result

This section describes summary of data totalization of weighing result.

Touch the "Summary" key  in the "Weighing window" to display the "Weighing history window".

"Weighing history" ↔ "All summary" ↔ "OK summary" ↔

"Number of samples summary" ↔ "Number of OK samples summary" ↔

"Histogram" ↔ " $\bar{X}$  control chart" ↔ "R control chart" ↔ "Weighing history"

### Note

- Histogram, control chart and summary results can output to USB flash drive and printer. Refer to the "7. Output of Weighing Results and Summary" concerning of how to output it.
- USB flash drive of FAT32 format can use only. Refer to the "8.1. Format of USB Flash Drive" concerning of how to format it.

### 5.7.1. Weighing History

The weighing result can display last 100 data in the weighing history window in maximum.

Touch the "Update" key  to update the display to latest history.

Touch the "Up arrow" key  to move to "R control chart window".

Touch the "Down arrow" key  to move to "All summary window".

Touch the "Return" key  to return to "Weighing window".

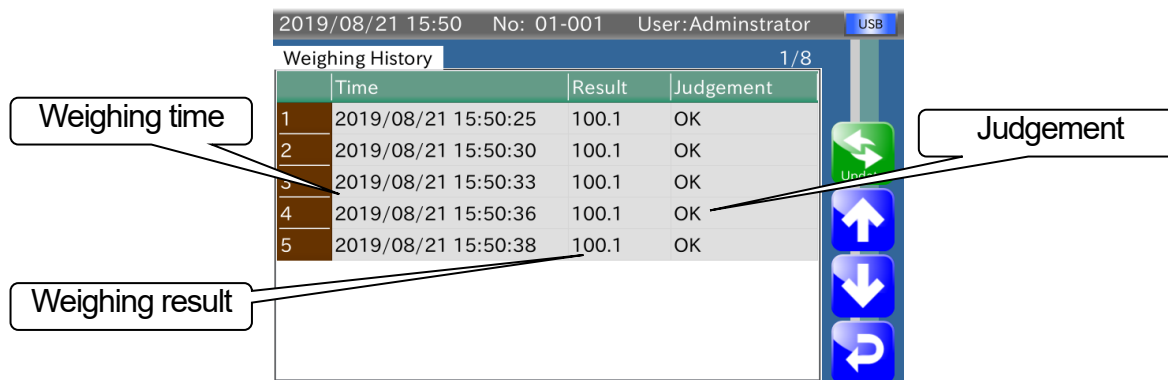

	Time	Result	Judgement
1	2019/08/21 15:50:25	100.1	OK
2	2019/08/21 15:50:30	100.1	OK
3	2019/08/21 15:50:33	100.1	OK
4	2019/08/21 15:50:36	100.1	OK
5	2019/08/21 15:50:38	100.1	OK

Drawing 45 Weighing history window

## 5.7.2. All Summary

The "All summary" means totalization of all weighing products that failed products is included.

Touch the "Clear" key  to delete "all summary" of all weighing results.

Touch the "Output" key  to display dialog box with output format of "all summary".

Summary result can be outputted, when USB flash drive is connected to USB port and the "PDF" key  is touched.

Summary result can be printed, when PostScript printer is connected to USB port and the "Print" key  is touched.

Summary result can be printed, when dump printer is connected to USB port and the "Print" key is touched.

Touch the "Up arrow" key  to move to the "Weighing history window".

Touch the "Down arrow" key  to move to the "OK summary window".

Touch the "Return" key  to return to "Weighing window".

### Note

- The summary results of "Print" and "PDF" includes all summary, OK summary, number of samples summary and number of OK samples summary.
- The summary result includes all summary, OK summary, number of samples summary and number of OK samples summary.

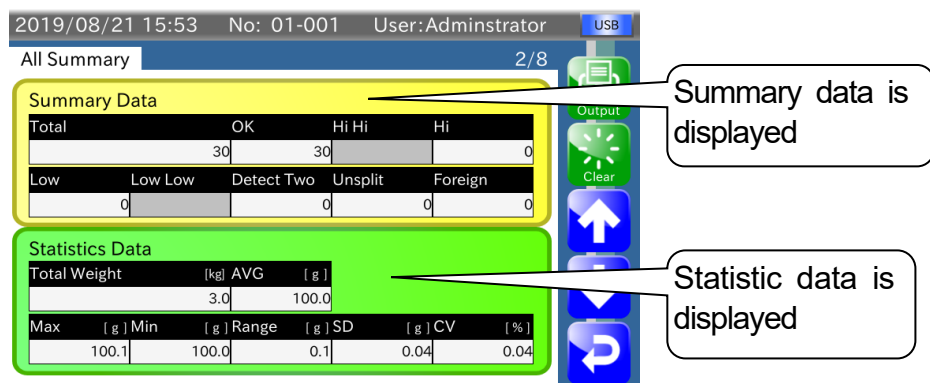

2019/08/21 15:53 No: 01-001 User:Administrator USB

All Summary 2/8

Summary Data

Total	OK	Hi Hi	Hi
30	30		0

Low Low Low Detect Two Unsplit Foreign

0		0	0
---	--	---	---

Statistics Data

Total Weight	[kg] AVG	[g]
3.0		100.0

Max	[g] Min	[g] Range	[g] SD	[g] CV	[%]
100.1		100.0	0.1	0.04	0.04

Summary data is displayed

Statistic data is displayed

Drawing 46 All summary window

## 5.7.3. OK Summary

The "OK summary" means totalization of weighing products that is passed.

Touch the "Up arrow" key  to move to the "All summary window".

Touch the "Down arrow" key  to move to the "Number of samples summary window".

Touch the "Return" key  to return to "Weighing window".

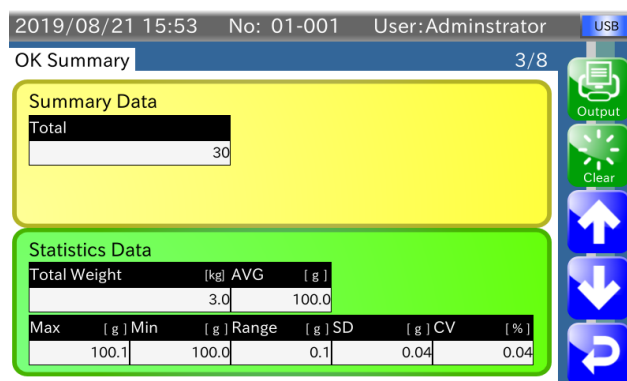

2019/08/21 15:53 No: 01-001 User:Administrator USB

OK Summary 3/8

Summary Data

Total
30

Statistics Data

Total Weight	[kg] AVG	[g]
3.0		100.0

Max	[g] Min	[g] Range	[g] SD	[g] CV	[%]
100.1		100.0	0.1	0.04	0.04

Summary data is displayed

Statistic data is displayed

Drawing 47 OK summary window

## 5.7.4. Number of Samples Summary

The "Number of samples summary" means totalization of weighing products per the specified number of samples concerning of the current product selected.

When the weighing in unit of specified number of samples is complete, the "Number of samples summary" will be reset.

The "Number of samples summary" includes failed product.

Touch the "Up arrow" key  to move to the "OK summary window".

Touch the "Down arrow" key  to move to the "Number of OK samples summary window".

Touch the "Return" key  to return to "Weighing window".

Example : In case of number of samples = 10

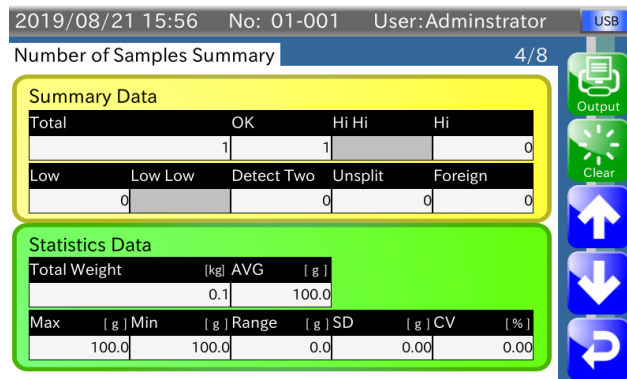
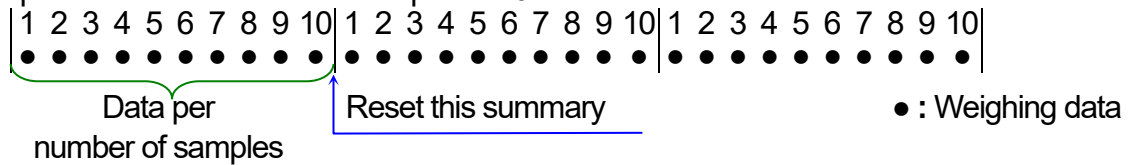



Drawing 48 Number for samples summary window

### 5.7.5. Number of OK Samples Summary

The "Number of OK samples summary" means totalization of passed weighing products per the specified number of samples concerning of the current product selected.

When the weighing of passed products in unit of specified number of samples is complete, the "Number of OK samples summary" will be reset.

Touch the "Up arrow" key  to move to the "Number of samples window".

Touch the "Down arrow" key  to move to the "Histogram window".

Touch the "Return" key  to return to "Weighing window".

Example : In case of number of samples = 10

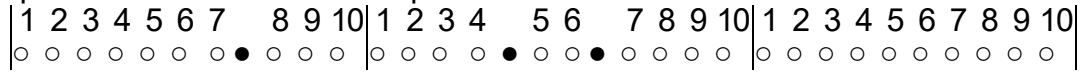

Data per number of OK samples      Reset this summary      ○ : OK product      ● : Failed product

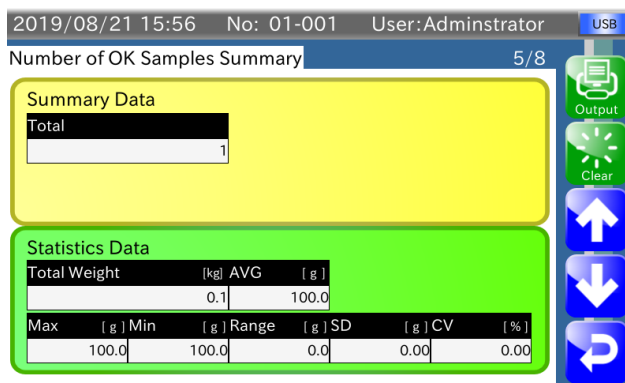

Drawing 49 Number for OK samples summary window

## 5.7.6. Histogram

A Histogram can display the frequency distribution of all summary (that includes failed products) concerning of the current product selected. Store the center value and section width of histogram for displaying and printing out in advance. The relation between the center value and section width of histogram is shown in Table 4 below. The center value is placed in section No.9 and frequency is counted for each section. The management level so as to clear a graph is required supervisor or greater user.

### Cautions



- Last center value and section width is used even if they are changed during summary processing. If the "Clear" key  is touched, the center value and section width are updated.
- When section width is changed, data of graph is deleted and section width is updated.
- Histogram excludes judgements of "Detect two", "Unsplit", "Ext 1", "Ext 2" and "Metal".

### Note

- Refer to "9.2.2. Target" and "9.6.5. Width of Section" for settings of the center value and section width of histogram. Center value : S, Section width : k



Table 4 Relation between ranges and border values

Section No.	Border value	Range
1	-	$w < W2$
2	$W2 = S - 7k$	$W2 \leq w < W3$
3	$W3 = S - 6k$	$W3 \leq w < W4$
4	$W4 = S - 5k$	$W4 \leq w < W5$
5	$W5 = S - 4k$	$W5 \leq w < W6$
6	$W6 = S - 3k$	$W6 \leq w < W7$
7	$W7 = S - 2k$	$W7 \leq w < W8$
8	$W8 = S - k$	$W8 \leq w < W9$
9	$W9 = S$	$W9 \leq w < W10$
10	$W10 = S + k$	$W10 \leq w < W11$
11	$W11 = S + 2k$	$W11 \leq w < W12$
12	$W12 = S + 3k$	$W12 \leq w < W13$
13	$W13 = S + 4k$	$W13 \leq w < W14$
14	$W14 = S + 5k$	$W14 \leq w < W15$
15	$W15 = S + 6k$	$W15 \leq w < W16$
16	$W16 = S + 7k$	$W16 \leq w$

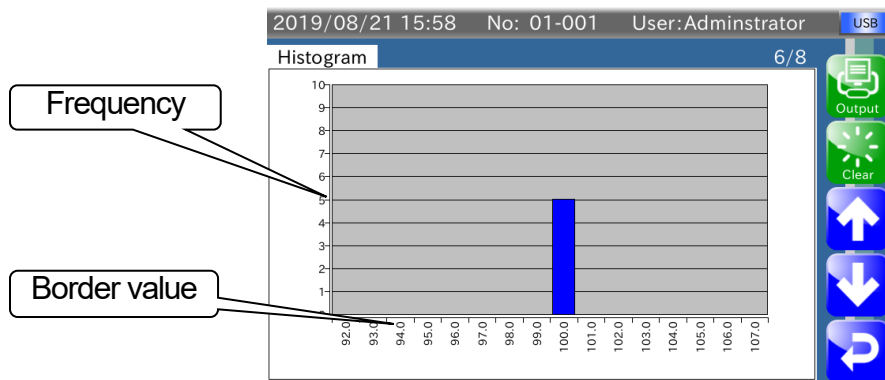
If the "Output" key  is touched, the dialog box of graph with output format is displayed. When USB flash drive is connected to USB port and the "PDF" key  is touched, graph can be outputted. When PostScript printer is connected to USB port and the "Print" key  is touched, It is printed.



Drawing 50 Histogram window

Touch the "Up arrow" key  to move to the "Number of OK samples window".  
 Touch the "Down arrow" key  to move to the " $\bar{X}$  Control Chart window".  
 Touch the "Return" key  to return to "Weighing window".

### 5.7.7. $\bar{X}$ Control Chart

The  $\bar{X}$  control chart is displayed based on number of samples, size of sample and data of  $\bar{X}$ .  
 If  $\bar{X}$  is used, graph is displayed based on  $\bar{X}$ .  
 If  $\bar{X}$  is 0,  $\bar{X}$  is calculated using weighing data inputted for control chart and graph is displayed.  
 Control chart is made using data that corresponds to size of sample per number of samples

**Note**

- Refer to "9.6.1. Num of Samples" and "9.6.2. Sub Samples" for number of sampled, size of sample.

Example : In case of number of samples = 10, size of samples = 5  
 First 5 samples (size of samples) from 10 samples are assumed as control chart data.

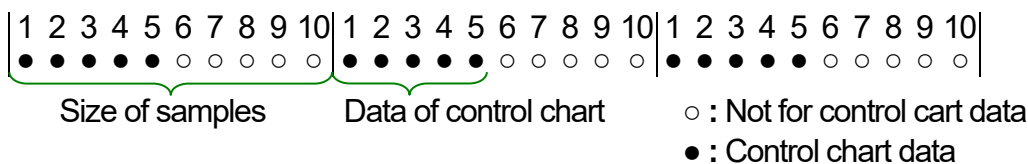



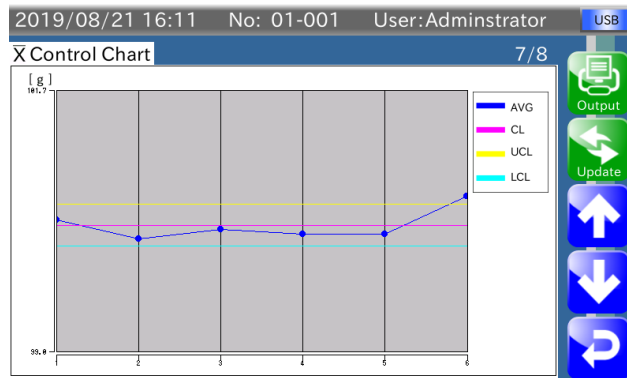

This data can be plotted like Drawing 51.  
 Touch the "Update" key  to update it.

**Note**

- $\bar{X}$  control chart and  $R$  control chart can be converted to PDF files and printing output.



**Drawing 51 Window of  $\bar{X}$  control chart**

Touch the "Output" key  to display dialog box to select output format of control chart.  
 The PDF file of control chart can be outputted, when USB flash drive is connected to USB port and the "PDF" key  is touched.  
 If postscript printer is connected to the indicator, the control chart can be printed when the "Print" key is touched.  
 Touch the "Up arrow" key  to move to the "Histogram window".  
 Touch the "Down arrow" key  to move to the " $\bar{R}$  Control Chart window".  
 Touch the "Return" key  to return to "Weighing window".



## 5.7.8. $\bar{R}$ Control Chart

The  $\bar{R}$  control chart is displayed based on number of samples, size of sample and data of  $\bar{R}$ . If  $\bar{R}$  is used, graph is displayed based on  $\bar{R}$ .

If  $\bar{R}$  is 0,  $\bar{R}$  is calculated using weighing data inputted for control chart and graph is displayed.

This data can be plotted like Drawing 52.

Touch the "Update" key  to update it.

### Note

- Refer to "9.6.4.  $\bar{R}$ " for  $\bar{R}$  settings.

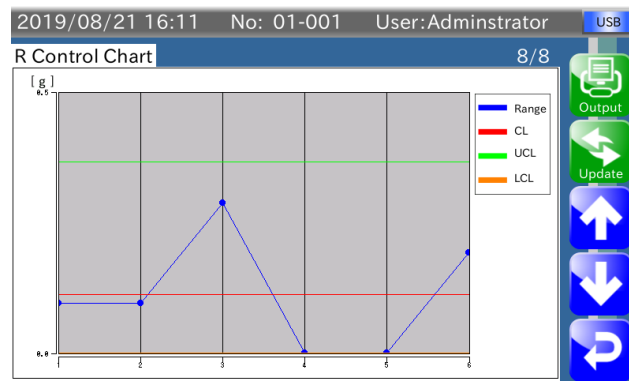

Drawing 52 Window of R control chart

Touch the "Up arrow" key  to move to the "Control chart window".

Touch the "Down arrow" key  to move to the "All summary window".

Touch the "Return" key  to return to "Weighing window".

## 6. Adjustment Operations for the Indicator

This chapter describes operations concerning of adjusting the indicator.

### 6.1. Calibrating the Indicator using a Weight

This section describes the adjustment procedure to display weighing value correctly. The procedure using calibration weight is shown below.

- Step 1. Login with "Quality Manager" or greater.
- Step 2. Touch the "Setting" key  on the "Weighing window" to display the "Common settings window".

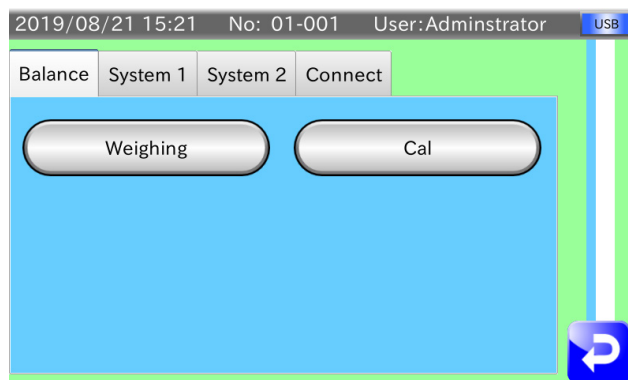

Drawing 53 Common settings window ( Balance tab)

- Step 3. Touch the "Adjust Cal" key on the "Balance" tab to display the "Cal window".

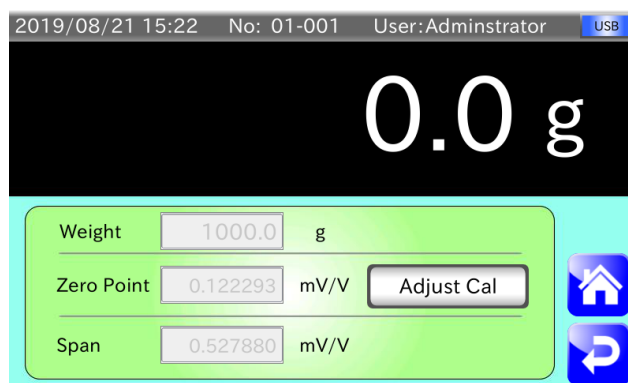

Drawing 54 Cal window

Step 4. Touch the "Adjust Cal" key to display the **"zero point calibration"** dialog box. Place nothing on the weighing conveyer and touch the "OK" key to store the zero point. If you want to cancel the current zero point calibration and to proceed to span calibration, touch the "Cancel" key.

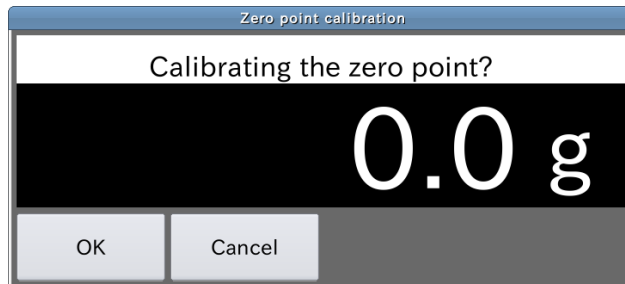

Drawing 55 Zero point calibration dialog box

Step 5. The **"span calibration"** dialog box is displayed after zero point calibration. Touch the "OK" key to display the **"weight value input dialog box"**. Input the weight value and touch the "OK" key to store it.

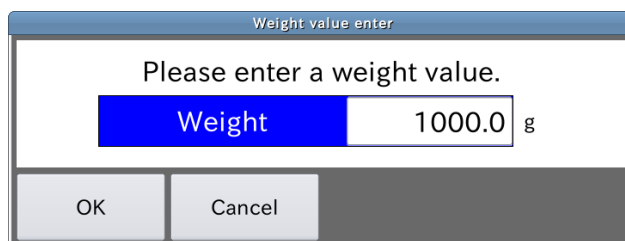

Drawing 56 Weight value input dialog box

Step 6. Touch the "OK" key to specify the calibration weight on the **"span calibration"** dialog box.



Drawing 57 Span calibration dialog box

Step 7. Touch the "Return" key  to return to the **"Common settings window"**.

## 6.2. Settings for Date and Time

This chapter describes how to set a built-in clock. The setting procedure is shown below.

- Step 1. Login with "Quality Manager" or greater.
- Step 2. Touch the "Setting" key  on the "weighing window" to display the "common settings window".
- Step 3. Select the "System setting 2" tab.  
Touch the "Date / Time" key to display to the "Date & time window".

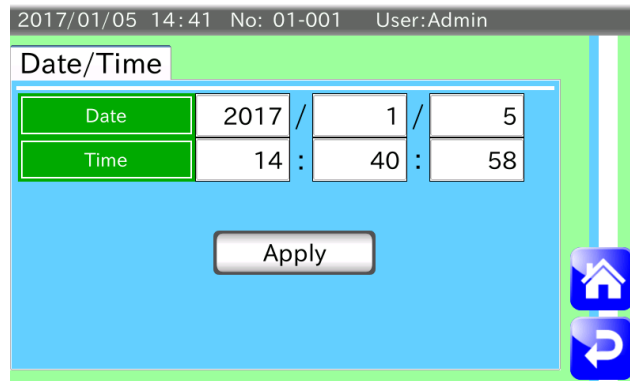

**Drawing 58** Date & time window

- Step 4. Select and input each data of year, month and date.
- Step 5. Select and input each data of hour, minute and second.
- Step 6. Touch the "Yes" key on the "New date and time" dialog box to store them.  
The clock is updated.



**Drawing 59** New date and time dialog box

- Step 7. Touch the "Return" key  to return to the "Common settings window".

## 6.3. Setting up LAN interface

This chapter describes the settings of LAN. The setting procedure is shown below.

### Cautions

- The password of factory setting is "123456789". Change the password at first use.
- Use 8 characters for the password.
- Number of connection to the indicator using LAN is 4 in maximum.

Step 1. Login with "Quality Manager" or greater.

Step 2. Touch the "Setting" key  on the "Weighing window" to display the "Common settings window".

Step 3. Select the "Connection" tab on the "Common settings window".  
Touch the "LAN" key to display the "LAN interface window".

Step 4. The indicator can use wired LAN and wireless LAN.  
These setting procedure are as follows :

### Wired LAN

Select and input each settings of IP address, subnet mask and default gateway.

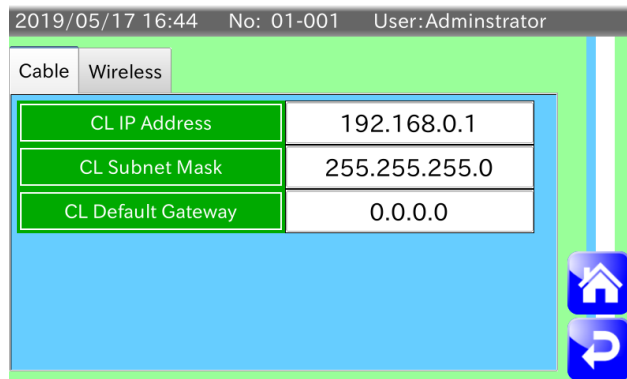

2019/05/17 16:44 No: 01-001 User:Administrator

Cable Wireless

CL IP Address	192.168.0.1
CL Subnet Mask	255.255.255.0
CL Default Gateway	0.0.0.0

Home Refresh

Drawing 60 LAN interface window (Cable tab)

### Wireless LAN

Choose use or invalid of the wireless port. Specify wireless IP address and password.

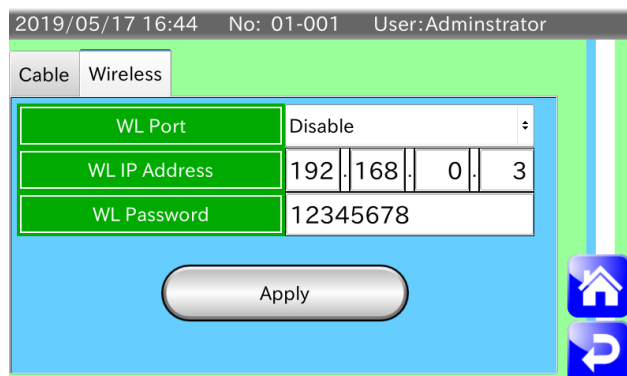

2019/05/17 16:44 No: 01-001 User:Administrator

Cable Wireless

WL Port	Disable
WL IP Address	192.168.0.3
WL Password	12345678

Apply

Home Refresh

Drawing 61 LAN interface window (Wireless tab)

Step 5. Turn the power off once and on again using the power switch.  
Then the settings of LAN has effective.

## 7. Output of Weighing Results and Summary

This indicator can output weighing data and summary of data totalization to the USB flash drive or printer. This chapter describes procedures of outputting data.

### 7.1. Output to USB Flash Drive

Weighing history, histogram, control chart and summary can be outputted.

#### Cautions

- ❑ The USB flash drive formatted in FAT32 can use.
- ❑ Do not remove the USB flash drive in accessing.

#### Note

- ❑ Refer to "[3.1.1. Connecting USB Flash Drive](#)" for the procedure to connect it.
- ❑ Refer to "[8.1. Format of USB Flash Drive](#)" for the procedure to format it.

#### 7.1.1. Output of Weighing History

This section describes the procedure to output weighing history. If weighing history is stored in the USB flash drive, file of weighing history is created with either condition below.

##### Condition to create new folder

New folder can be created in the condition that the following conditions is effective and a folder of folder name "AD4412CW\_date of folder creation" is not in root directory of the USB flash drive.

- ❑ At turning on the power.
- ❑ After connecting USB flash drive.
- ❑ After clock data is updated.

##### Condition to create new file

- ❑ When the condition of new folder is met.
- ❑ When data counts of weighing history becomes 65000 or above.
- ❑ When weighing history is stored, an error occurred.

The weighing history file with CSV format is stored into folder that is created at root of the USB flash drive.

File name stored in folder is "Date of file creation\_Time of file creation\_Weight\_Result.csv".

The procedure to output weighing history is shown below.

- Step 1. Insert the USB flash drive to USB port of the indicator.
- Step 2. When USB flash drive is connected, USB indicator is displayed at upper-right area of the display.



Confirm the connection of the USB flash drive and start weighing.

- Step 3. When weighing is performed, weighing history is stored in the USB flash drive.
- Step 4. When you want to remove the USB flash drive, remove it after touch and hold the USB indicator until it is hidden.

## 7.1.2. Example: Output File of Weighing History

The format outputted to the USB flash drive is shown below.

"Date (year / month / day), time (hour : minute : second, 10 milliseconds.),  
group number – product number, weighing result, judgement result"

Example of this format is shown to Drawing 62.

Judgement result outputted to the USB flash drive is shown below.

2018/7/12,	10:03:12,	54,	01-001,	100.5,	OK
2018/7/12,	10:03:49,	40,	01-001,	162.7,	HiHi
2018/7/12,	10:04:26,	58,	01-001,	123.9,	Hi
2018/7/12,	10:05:02,	52,	01-001,	97.1,	Lo
2018/7/12,	10:05:38,	56,	01-001,	80.1,	LoLo
2018/7/12,	10:06:00,	60,	01-001,	0.0,	Detect Two
2018/7/12,	10:06:32,	54,	01-001,	0.0,	Unsplit
2018/7/12,	10:06:59,	78,	01-001,	100.6,	Metal
2018/7/12,	10:07:29,	34,	01-001,	102.5,	Ext1
2018/7/12,	10:07:57,	80,	01-001,	98.4,	Ext2

**Drawing 62** Output sample of weighing history

**Table 5** Relation between results and meanings

Judgment results in file	Description
OK	Passed (within target weighing value)
HiHi	Weighing value is bigger than HiHi limit value.
Hi	Over weight. Weighing value is bigger than Hi limit value.
Lo	Under weight. Weighing value is smaller than Lo limit value.
LoLo	Weighing value is smaller than LoLo limit value.
Detect Two	The next product is conveyed to the weighing conveyor before the weighing value of the previous product is confirmed.
Unsplit	The product length is longer than the specified product length.
Metal	Metal detected
Ext 1	External 1
Ext 2	External 2

### 7.1.3. PDF output of Histogram, Control Chart and Summary

---

This section describes the procedure to output PDFs of histogram, control chart and summary of totalization result to the USB flash drive.

The procedure of outputting each PDF file is shown below.

#### Note

- Refer to from "7.2.2. Printing Sample of Histogram" to "7.2.4. Print Sample of Summary" concerning of histogram, control chart and summary of totalization result outputted to the USB flash drive.
- The file name of PDF outputted to the USB flash drive is "AD4412CW\_PDF\_date of folder creation".

Step 1. Insert the USB flash drive to USB port of the indicator.

Step 2. Confirm the connection of the USB flash drive. Start weighing.

Step 3. Display summary of data that must store after weighing.

Step 4. Touch the "Output" key  of the "Summary window" to display the "Output format" dialog box.

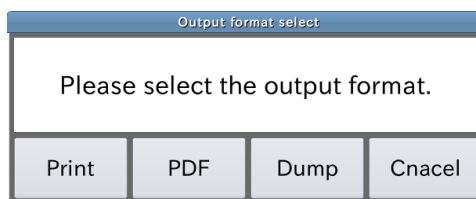

Drawing 63 Output format dialog box

Step 5. Touch the "PDF" key to display the "PDF output" dialog box.

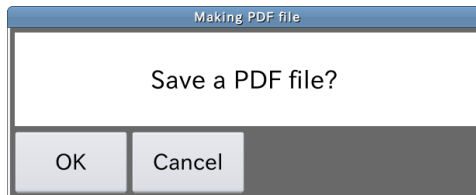

Drawing 64 PDF output dialog box

Step 6. Touch the "OK" key to output PDF file to the USB flash drive.



## 7.2. Output to the Postscript Printer

Histogram, control chart and summary of totalization data can be output to PostScript printer and PDF file.

### Cautions

- PostScript printer is required for printer output.

### Note

- Refer to "8.3. Connecting the PostScript Printer" for connecting printer.

### 7.2.1. Output to Postscript Printer

---

The procedure of printing data is shown below.

Step 1. Display the summary window to be printed after weighing.

Step 2. Touch the "Output" key  to display the "Output format" dialog box.

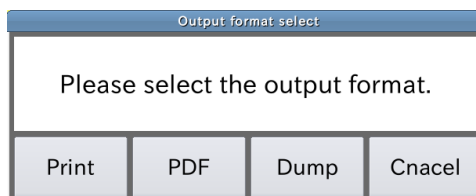

Drawing 65 Output format dialog box

Step 3. Touch the "Print" key to display the "Print setting" dialog box.

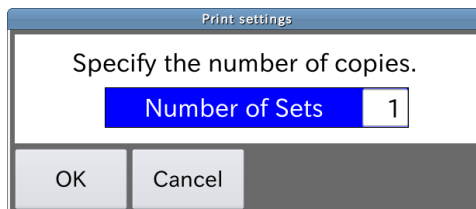

Drawing 66 Print setting dialog box

Step 4. Select and input number of printing.

Step 5. Touch the "OK" key to print them.

## 7.2.2. Printing Sample of Histogram

Printing sample of histogram is shown below.

The PDF file outputted to the USB flash drive is the same as this printing sample.

### The three stage separation

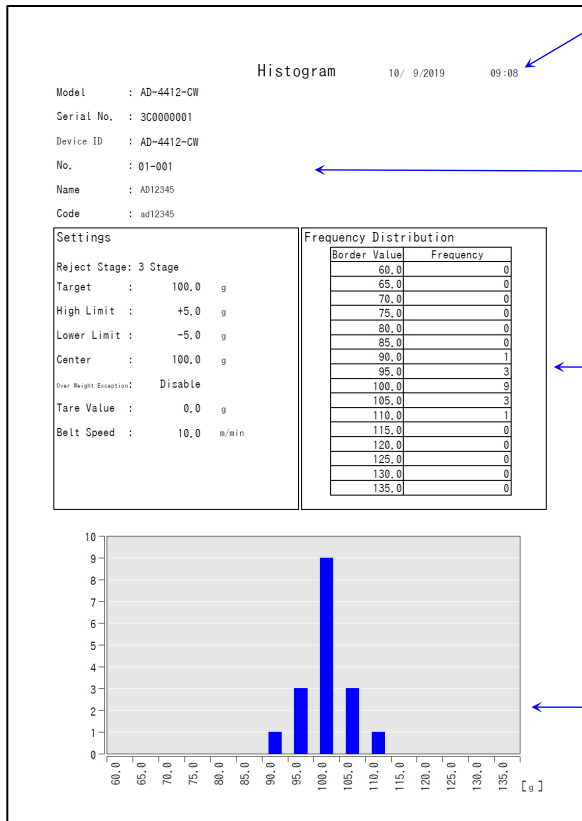

Printed date

Contents :

Product number, product name, product code, target value, high limit value, Lo limit value, center value of histogram, over weight exception, tare value, processing number, belt

Frequency distribution

The display of frequency for each section.

Frequency distribution

The display of frequency for each section.

### The five stage separation

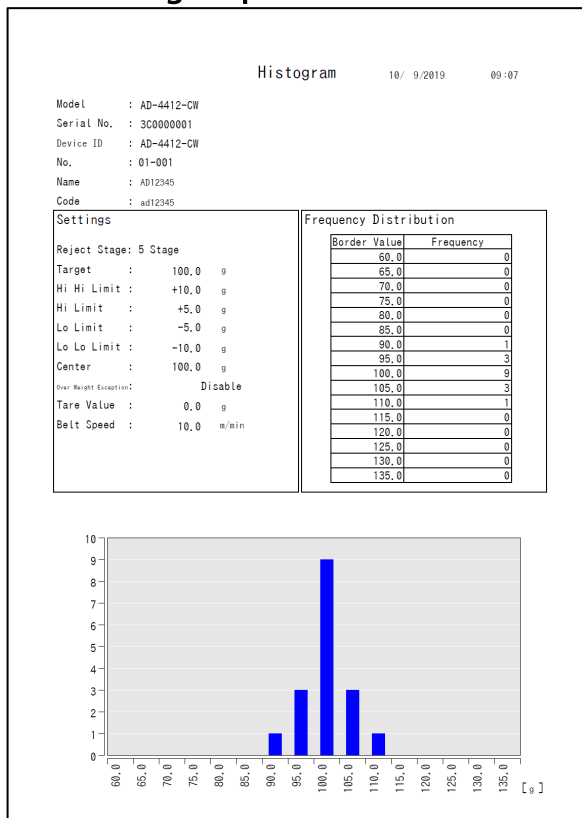

### 7.2.3. Print Sample of Control Chart

Printing sample of control chart is shown below.

The PDF file outputted to the USB flash drive is the same as this printing sample.

#### The three stage separation

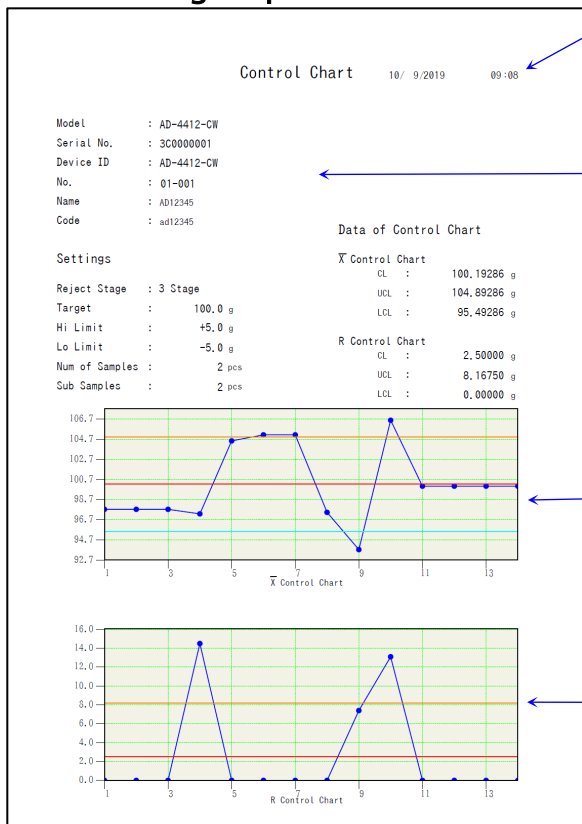

Printed date

Contents :  
 Product number, product name, product code,  
 target value, high limit value, Lo limit value,  
 number of samples, sub samples

$\bar{X}$  control chart

R control chart

#### The five stage separation

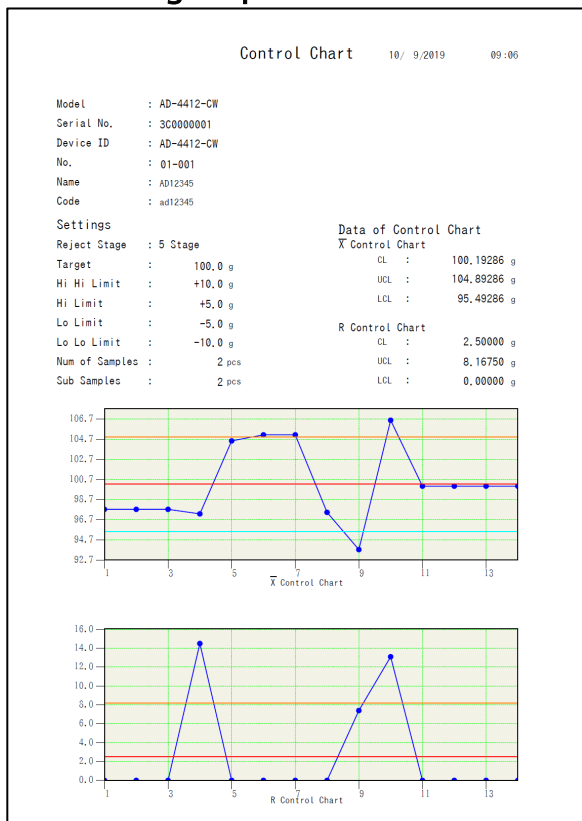

## 7.2.4. Print Sample of Summary

Printing sample of summary is shown below.

The PDF file outputted to the USB flash drive is the same as this printing sample.

### The three stage separation

Summary      10/ 9/2019      09:08

Model : AD-4412-CW  
 Serial No. : 3C0000001  
 Device ID : AD-4412-CW  
 No. : 01-001  
 Name : AD12345  
 Code : ad12345

Settings

Reject Stage : 3 Stage  
 Target : 100.0 g  
 High Limit : +5.0 g  
 Lower Limit : -5.0 g  
 Over Weight Exception : Disable  
 Tare Value : 0.0 g  
 Belt Speed : 10.0 m/min

Summary Data

	All	OK	Number of Samples	Number of OK Samples
Total	28	21	2	1
OK	21	21	2	1
Over	5		0	
Under	2		0	
Two Detect	2		0	
Unsplit	0		0	
Foreign	0		0	

Statistics Data

	All	OK	Number of Samples	Number of OK Samples
Total Weight [kg]	2.8	2.1	0.2	0.1
AWG Weight [g]	100.2	99.6	100.0	100.0
Max [g]	113.1	104.5	100.0	100.0
Min [g]	90.0	97.4	100.0	100.0
Range [g]	23.1	7.1	0.0	0.0
SD [g]	4.66	2.34	0.00	0.00
CV [%]	4.65	2.35	0.00	0.00

Printed date

Contents :

Product number, product name, product code, target value, high limit value, Lo limit value, over weight exception, tare value, number, belt speed.

### The five stage separation

Summary      10/ 9/2019      09:07

Model : AD-4412-CW  
 Serial No. : 3C0000001  
 Device ID : AD-4412-CW  
 No. : 01-001  
 Name : AD12345  
 Code : ad12345

Settings

Reject Stage : 5 Stage  
 Target : 100.0 g  
 Hi Hi Limit : +10.0 g  
 Hi Limit : +5.0 g  
 Lo Limit : -5.0 g  
 Lo Lo Limit : -10.0 g  
 Over Weight Exception : Disable  
 Tare Value : 0.0 g  
 Belt Speed : 10.0 m/min

Summary Data

	All	OK	Number of Samples	Number of OK Samples
Total	28	21	2	1
OK	21	21	2	1
Hi Hi	0		0	
Hi	0		0	
Lo	0		0	
Lo Lo	0		0	
Two Detect	2		0	
Unsplit	0		0	
Foreign	0		0	

Statistics Data

	All	OK	Number of Samples	Number of OK Samples
Total Weight [kg]	2.8	2.1	0.2	0.1
AWG Weight [g]	100.2	99.6	100.0	100.0
Max [g]	113.1	104.5	100.0	100.0
Min [g]	90.0	97.4	100.0	100.0
Range [g]	23.1	7.1	0.0	0.0
SD [g]	4.66	2.34	0.00	0.00
CV [%]	4.65	2.35	0.00	0.00

## 7.3. Output to the Dump Printer

Summary data and statistic data can be output to the dump printer such as AD-8126 that can connect to the RS-232C interface.

Dump printer can be used for printing of a summary or weighing result that is smaller than approximately 100 piece per minute or less.

RS-232C is used to the connection between this indicator and dump printer.

### Cautions

- The format of dump printer is 24 characters per line.  
Use the printer that can print 24 characters or more per line.
- Printing data are all summary, OK summary, number of samples summary and number of OK samples summary. Histogram cannot print.
- Terminator is fixed to <CR> <LF>.

### Note

- Refer to "9.25. Output Format" for data output of each weighing.
- Data can be received at the computer connected to serial interface.

### 7.3.1. Output to the Dump Printer

---

The procedure to print each data using the printer is shown below.

Step 1. Display the window ( of all summary, OK summary, number of samples summary and number of OK samples summary) to print data after weighing.

Step 2. Touch the "Output" key  to display the "Output format" dialog box.

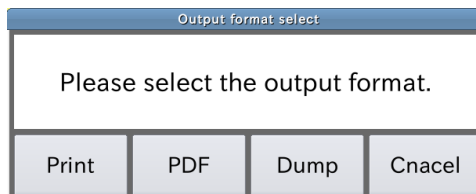

Drawing 67 Output format dialog box

Step 3. Touch the "Print" key to display the "Print output" dialog box.



Drawing 68 Printing output dialog box

Step 4. Touch the "OK" key to print them.

## 7.3.2. Print Samples

### All Summary by Data Totalization

#### The three stage separation

```
***** TOTAL *****  
Date:      2019/05/17  
Time:      13:11:02
```

```
Model:      AD-4412-CU  
Serial No:  1R0000001  
Identification Name:  
0123456789abcdefghij
```

#### SETTINGS

```
NO.          01-001  
Name  
0123456789abcde
```

```
Code  
0123456789abcdefghij
```

```
Reject Stage: 3 Stage  
Target:      +01234.56 g  
Hi Limit:   +01234.56 g  
Lo Limit:   +01234.56 g  
Reject Over: Disable  
Tare Value: +01234.56 g  
Belt Speed:  80.0m/min
```

#### SUMMARY DATA

```
Total:      12345 Pcs  
OK:         12345 Pcs  
Hi:         12345 Pcs  
Lo:         12345 Pcs  
Detect Two: 12345 Pcs  
Unsplit:    12345 Pcs  
Foreign:    12345 Pcs
```

#### STATISTICS DATA

```
Total Weight: +012345.6kg  
Average:      +01234.56 g  
Max Weight:   +01234.56 g  
Min Weight:   +01234.56 g  
Range:       +01234.56 g  
SD:          +0123.456 g  
CV:          +0123.456 %
```

#### The five stage separation

```
***** TOTAL *****  
Date:      2019/05/17  
Time:      13:11:02
```

```
Model:      AD-4412-CU  
Serial No:  1R0000001  
Identification Name:  
0123456789abcdefghij
```

#### SETTINGS

```
NO.          01-001  
Name  
0123456789abcde
```

```
Code  
0123456789abcdefghij
```

```
Reject Stage: 5 Stage  
Target:      +01234.56 g  
Hi Hi Limit: +01234.56 g  
Hi Limit:   +01234.56 g  
Lo Limit:   +01234.56 g  
Lo Lo Limit: +01234.56 g  
Reject Over: Disable  
Tare Value: +01234.56 g  
Belt Speed:  80.0m/min
```

#### SUMMARY DATA

```
Total:      12345 Pcs  
OK:         12345 Pcs  
Hi Hi:      12345 Pcs  
Hi:         12345 Pcs  
Lo:         12345 Pcs  
Lo Lo:      12345 Pcs  
Detect Two: 12345 Pcs  
Unsplit:    12345 Pcs  
Foreign:    12345 Pcs
```

#### STATISTICS DATA

```
Total Weight: +012345.6kg  
Average:      +01234.56 g  
Max Weight:   +01234.56 g  
Min Weight:   +01234.56 g  
Range:       +01234.56 g  
SD:          +0123.456 g  
CV:          +0123.456 %
```

# OK Summary by Data Totalization

## The three stage separation

```
***** OK *****
Date:      2019/05/17
Time:      13:11:02

Model:     AD-4412-CU
Serial No: 1R0000001
Identification Name:
0123456789abcdef9hij

SETTINGS

NO.        01-001
Name
0123456789abcde

Code
0123456789abcdef9hij

Reject Stage: 3 Stage
Target:      +01234.56 g
Hi Limit:   +01234.56 g
Lo Limit:   +01234.56 g
Reject Over: Disable
Tare Value: +01234.56 g
Belt Speed: 80.0m/min

SUMMARY DATA

Total:      12345 pcs
OK:        12345 pcs

STATISTICS DATA

Total Weight:
Average:    +012345.6kg
Max Weight: +01234.56 g
Min Weight: +01234.56 g
Range:     +01234.56 g
SD:        +0123.456 g
CV:        +0123.456 %
```

## The five stage separation

```
***** OK *****
Date:      2019/05/17
Time:      13:11:02

Model:     AD-4412-CU
Serial No: 1R0000001
Identification Name:
0123456789abcdef9hij

SETTINGS

NO.        01-001
Name
0123456789abcde

Code
0123456789abcdef9hij

Reject Stage: 5 Stage
Target:      +01234.56 g
Hi Hi Limit: +01234.56 g
Hi Limit:   +01234.56 g
Lo Limit:   +01234.56 g
Lo Lo Limit: +01234.56 g
Reject Over: Disable
Tare Value: +01234.56 g
Belt Speed: 80.0m/min

SUMMARY DATA

Total:      12345 pcs
OK:        12345 pcs

STATISTICS DATA

Total Weight:
Average:    +012345.6kg
Max Weight: +01234.56 g
Min Weight: +01234.56 g
Range:     +01234.56 g
SD:        +0123.456 g
CV:        +0123.456 %
```

## Number of Samples Summary by Data Totalization

### The three stage separation

```
*** Number of Samples ***
Date:      2019/05/17
Time:      13:11:02

Model:      AD-4412-CU
Serial No:  1R00000001
Identification Name:
0123456789abcdefghijklmnopqrstuvwxyz

SETTINGS

NO.          01-001
Name
0123456789abcde

Code
0123456789abcdefghijklmnopqrstuvwxyz

Reject Stage:  3 Stage
Target:        +01234.56 g
Hi Limit:      +01234.56 g
Lo Limit:      +01234.56 g
Reject Over:   Disable
Tare Value:    +01234.56 g
Belt Speed:    80.0m/min

SUMMARY DATA

Total:         12345 Pcs
OK:            12345 Pcs
Hi:            12345 Pcs
Lo:            12345 Pcs
Detect Two:    12345 Pcs
Unsplit:       12345 Pcs
Foreign:       12345 Pcs

STATISTICS DATA

Total Weight:  +012345.6kg
Average:        +01234.56 g
Max Weight:     +01234.56 g
Min Weight:     +01234.56 g
Range:          +01234.56 g
SD:             +0123.456 g
CV:             +0123.456 %
```

### The five stage separation

```
*** Number of Samples ***
Date:      2019/05/17
Time:      13:11:02

Model:      AD-4412-CU
Serial No:  1R00000001
Identification Name:
0123456789abcdefghijklmnopqrstuvwxyz

SETTINGS

NO.          01-001
Name
0123456789abcde

Code
0123456789abcdefghijklmnopqrstuvwxyz

Reject Stage:  5 Stage
Target:        +01234.56 g
Hi Hi Limit:   +01234.56 g
Hi Limit:      +01234.56 g
Lo Limit:      +01234.56 g
Lo Lo Limit:   +01234.56 g
Reject Over:   Disable
Tare Value:    +01234.56 g
Belt Speed:    80.0m/min

SUMMARY DATA

Total:         12345 Pcs
OK:            12345 Pcs
Hi Hi:         12345 Pcs
Hi:            12345 Pcs
Lo:            12345 Pcs
Lo Lo:         12345 Pcs
Detect Two:    12345 Pcs
Unsplit:       12345 Pcs
Foreign:       12345 Pcs

STATISTICS DATA

Total Weight:  +012345.6kg
Average:        +01234.56 g
Max Weight:     +01234.56 g
Min Weight:     +01234.56 g
Range:          +01234.56 g
SD:             +0123.456 g
CV:             +0123.456 %
```



# Number of OK Samples Summary by Data Totalization

## The three stage separation

```
* OK(Number of Samples)*
Date:      2019/05/17
Time:      13:11:02

Model:      AD-4412-CW
Serial No:  1R0000001
Identification Name:
0123456789abcdefghij

SETTINGS

NO.          01-001
Name
0123456789abcde

Code
0123456789abcdefghij

Reject Stage:  3 Stage
Target:        +01234.56 g
Hi Limit:      +01234.56 g
Lo Limit:      +01234.56 g
Reject Over:   Disable
Tare Value:    +01234.56 g
Belt Speed:    80.0m/min

SUMMARY DATA

Total:         12345 pcs
OK:            12345 pcs

STATISTICS DATA

Total Weight:
Average:       +012345.6kg
Max Weight:    +01234.56 g
Min Weight:    +01234.56 g
Range:         +01234.56 g
SD:            +0123.456 g
CV:            +0123.456 %
```

## The five stage separation

```
* OK(Number of Samples)*
Date:      2019/05/17
Time:      13:11:02

Model:      AD-4412-CW
Serial No:  1R0000001
Identification Name:
0123456789abcdefghij

SETTINGS

NO.          01-001
Name
0123456789abcde

Code
0123456789abcdefghij

Reject Stage:  5 Stage
Target:        +01234.56 g
Hi Hi Limit:   +01234.56 g
Hi Limit:      +01234.56 g
Lo Limit:      +01234.56 g
Lo Lo Limit:   +01234.56 g
Reject Over:   Disable
Tare Value:    +01234.56 g
Belt Speed:    80.0m/min

SUMMARY DATA

Total:         12345 pcs
OK:            12345 pcs

STATISTICS DATA

Total Weight:
Average:       +012345.6kg
Max Weight:    +01234.56 g
Min Weight:    +01234.56 g
Range:         +01234.56 g
SD:            +0123.456 g
CV:            +0123.456 %
```

## 8. Peripherals

This chapter describes operations of peripherals and the way of connecting them.

### 8.1. Format of USB Flash Drive

This section describes the procedure of formatting the USB flash drive.  
The procedure of formatting the USB flash drive is shown below.

#### Cautions

- When the USB flash drive is formatted, the whole of data stored in it is deleted.
- Make backup data in advance before formatting the USB flash drive because the deleted data cannot restore.

#### Note

- Refer to the "[3.1.2. Removing USB Flash Drive](#)" for how to remove the USB flash drive.

Step 1. Login with "Quality Manager" or greater.

Step 2. Connect the USB flash drive to the USB port on the indicator.

Step 3. When USB flash drive is connected, USB indicator is displayed at upper-right area of the display.



Step 4. Touch the "Setting" key  on the "Weighing window" to display the "Common settings window".

Step 5. Select the the "system 2" tab of the "Common settings window".  
Touch the "USB memory" key.

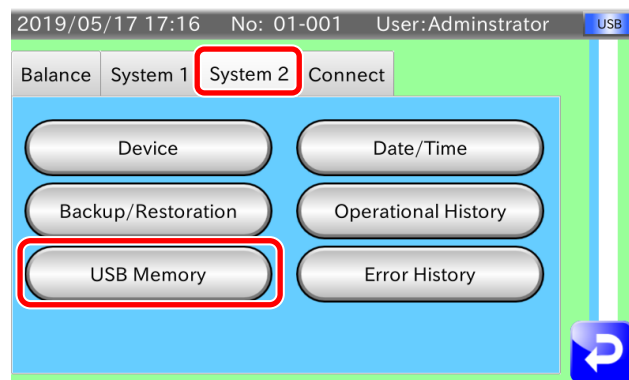

Drawing 69 Common settings window ( System tab 2)

Step 6. Confirm the USB indicator on the "USB memory window". The USB indicator is displayed when connecting the USB flash drive.

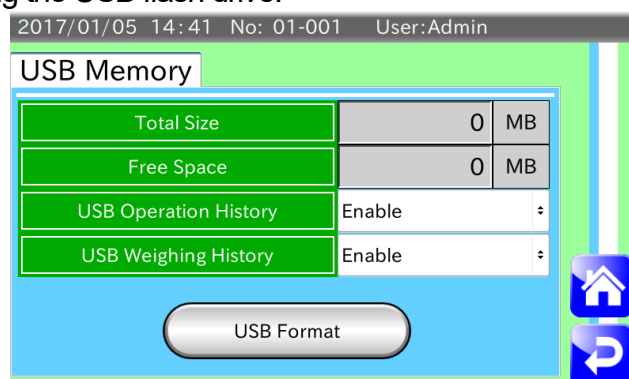

Drawing 70 USB Memory window

- Step 7. Touch the "USB format" key to display the confirmation dialog box. Touch the "OK" key to format it.
- Step 8. Wait that the formatting finishes.
- Step 9. Touch the "Return" key  to return to the "Common settings window".

## 8.2. Connecting the LAN interface

This section describes the connection of wired LAN and wireless LAN that is built in the indicator. The procedure of connecting them is shown below.

### 8.2.1. How to Connect to Network Using Wired LAN

---

The wired LAN is used when Modbus communication using "Modbus TCP" is performed. Connect the connector of LAN cable in the market to the LAN terminal on the rear panel, connect the other to LAN terminal of master device or Ethernet hub.

#### Note

- Store the settings of wired LAN in advance, if Modbus communication using "Modbus TCP" is performed.
- Refer to the "[6.3. Setting up LAN interface](#)" concerning the settings of wired LAN.

### 8.2.2. How to Connect to Network Using Wireless LAN

---

The wireless LAN is used when remote network monitoring is performed. Prepare a communication device such as personal computer, tablet or smartphone that wireless LAN is built-in.

Select this indicator from wireless network list of the communication device.

Enter SSID "AD-4412CW-xxxxxxxxxx" and password.

"xxxxxxxxxx" is serial number of the indicator.

#### Cautions

- The password of factory setting is "123456789". Change the password at first use.

#### Note

- Store the settings of wireless LAN in advance, if remote network monitoring is performed.
- Refer to the "[6.3. Setting up LAN interface](#)" concerning the settings of wireless LAN including password.

## 8.3. Connecting the PostScript Printer

PostScript printer is used printing of graph and summary result.

The connection between the indicator and printer is used wired LAN.

### Cautions

- Consult to network manager concerning connection between the indicator and printer.
- Refer to the accessory manual concerning IP address for the printer.
- Store IP address for the printer in advance, if printer is connected to wired LAN.

### Note

- Refer to the "6.3. Setting up LAN interface" concerning the settings of wired LAN.
- Refer to the "9.16.1. Printer IP Address " concerning IP address for the printer.

## 8.4. Remote Monitor

Remote network monitoring using wireless is the function that can monitor information of the indicator and statistical data etc. by external network devices in real time.

After the indicator and external device are connected to network, if you access to IP address of the indicator using web browser, monitoring window is displayed.

Example : `http:// xxx.xxx.xxx.xxx` (is preset IP address of wireless LAN)

The screenshot shows a web interface with a navigation bar at the top containing buttons for Home, Summary, Histogram, and Chart. Callout boxes point to these buttons with labels: 'To statistic window (Summary window)' for Summary, 'To histogram window' for Histogram, and 'To control chart window' for Chart.

Below the navigation bar, there are several data panels:

- Information** (red border):
 

Device ID	: AD-4412-CW-3C0000001
Serial No.	: 3C0000001
Weighing Status	: Belt Stop
Processing Number	: 0.00pcs/min
- Products** (yellow background):
 

No.	: 01-001
Name	: AD4412
Code	: ad4412
- Settings** (cyan background):
 

Target	: 100g	Reject Stage	: 5Stage
Hi Hi Target	: 10g	Hi Target	: 5g
Lo Target	: 5g	Lo Lo Target	: 10g
Over Weight Exception	: Disable	Tare	: 0g
Belt Speed	: 10.0m/min		
- Summary Data** (yellow background):
 

Total	OK	Hi Hi	Hi
0	0	0	0
Lo	Lo Lo	Detect Two	Unsplit
0	0	0	0
Foreign			
0			
- Statistics Data** (green background):
 

Total Weight[kg]	AVG[g]
0	0
Max[g]	Min[g]
0	0
Range[g]	SD[g]
0	0.0
CV[%]	
0.0	

Drawing 71 Remote monitor (home window)

Ver.01.00.01

Information that can monitor from remote network monitor is as follows :

- Product information
- Content of product settings
- Summary of totalization data
- Statistic data
- Histogram
- Control chart

### **Cautions**

- We cannot recommend use such as continuous monitoring because wireless LAN may become unstable depended on placed environment.
- Browsers that has checked operations are Microsoft Edge, Google Chrome, Mozilla Firefox and Safari. Internet Explorer does not work properly.
- Refer to accessory manual of wireless LAN for settings of wireless LAN.

### **Note**

- Browsable information of statistical data, histogram and control chart are the same as contents of PDF and printer etc.

## **8.5. Replacing Product Using Serial Communication**

The indicator can replace product using serial communication of RS-232C interface.

The procedure of replacement of product is as follows :

The indicator is receives product code form peripherals of bar code reader or PLC etc. and searches product code from product group. The replacement is performed.

### **Cautions**

- Product code received during replacement is ignored.

### **Note**

- The settings of RS-232C needs if the replacement using serial communication is performed.
- Refer to the "[9.26. RS-232C](#)" for the settings of RS-232C.

# 9. The Details of Settings

Details of settings for the weighing indicator are described in this chapter. Refer to "Table 6 of setting list according to product" and "Table 7 of common settings list" for windows and settings of the indicator.

Part 1 / 2 of Setting List

Table 6 of setting list according to product

Product setting window	Edit tab	Product name		
		Product code		
	Detect function tab	Detect basis	Reject stage	
			Target	
			Hi Hi limit	
			Hi limit	
			Lo limit	
			Lo Lo limit	
			Over weight exception	
			Consecutive fail stop	
			Consecutive fail num	
		Detect Parameter	Product length	
			Speed	
			Weighing mode	
			Conveyor stop timer	
			Product detection	
			Near zero range	
			Auto mode	
			Filter	
			Judge timer	
			Average timer	
	DO	DO map	Reference	
			OK	
			HiHi	
			Hi	
			Lo	
			LoLo	
			Detect two	
			Unsplit	
			Metal	
			Ext 1	
			Ext 2	
			Belt running	
Belt stop				
Consecutive fail				
Emergency stop on				
Weighing error				
Photo eye sensor error				
Bin full				
Air pressure				
Total number count				
OK item count				
Reject confirmation				
Reject photo eye sensor				

Part 2/2 of Setting List

Product setting window	Detect function tab	DO	DO map	FC+	
				FC-	
				+Zone 1	
				+Zone 2	
				+Zone 3	
				+Zone 4	
				+Zone 5	
				-Zone 1	
				-Zone 2	
				-Zone 3	
				-Zone 4	
				-Zone 5	
				Main unit DO behavior	Behavior
					Delay time
					Hold time
		Option port 1 DO behavior	Polarity		
			Behavior		
	Delay time				
	Option port 2 DO behavior	Hold time			
		Polarity			
		Behavior			
	Statistical	Delay time			
		Hold time			
		Polarity			
		Num of samples			
		Sub samples			
	Control revision tab	Tare Auto zero	$\bar{X}$		
			$\bar{R}$		
			Width of section		
			Tare		
			Auto zero range		
			Dead zone timer		
			Observation timer		
		Dynamic compensation	Averaging time		
			Auto zero sample		
		Feedback control	Coe		
			D. comp value (Dynamic compensation value)		
			Feedback control target		
			Feedback control range		
			Feedback control step [ g/sec ]		
			Feedback control step [ sec/g ]		
		Step control	Feedback control sample		
			Feedback control wait time		
	Control target				
	Zone 1				
	Zone 2				
	Zone 3				
Zone 4					
10C sample					
10C wait time					

Common setting window	Balance tab	Weighing	Unit	g	
			Decimal point	0	
			Division	1	
			Capacity	3000 g	
			Digital filter	0 %	
			Zero point range	7 Hz	
			Power on auto zero range	10 %	
			Zero tracking time	1 sec.	
			Zero tracking weight	0.5 digit	
			Stability time	1.0 sec.	
			Stability weight	2 digit	
			Cal	Cal weight	
				Zero point	
		Span			
	System 1 tab	Main unit	Identification name		
			Startup user level	operator	
			Conveyer length		
			Unsplit range	20 %	
			Conveyor mode	Invalid	
			Connect device priority	Invalid	
			Curb chattering	0 sec.	
			Photo eye sensor polarity	True	
			Photo eye sensor time out	30 sec.	
			Random check	Invalid	
		Display	Language	English	
			Display mode	Weighing result	
			Negative weight	Display	
			Display data	Display data weight	
			Standby mode	0 sec.	
			Brightness		
		DI	DI map	OK	
				HiHi	
				Hi	
				Lo	
				LoLo	
				Detect two	
				Unsplit	
				Material	
				Ext 1	
				Ext 2	
			Main unit DI behavior	Input trigger	
Configuration					
Delay time					
Chattering					
Option port 1 DI behavior	Input trigger				
	Configuration				
	Delay time				
	Chattering				
Option port 2 DI behavior	Input trigger				
	Configuration				
	Delay time				
	Chattering				
DI indicator					



Part 2/3 of Common Settings List

Common setting window	System 1 tab	Analog out	Analog out 1	Data types
				Output format
				Low voltage standard
				High voltage standard
				Low voltage output
				High voltage output
				Low current standard
			High current standard	
			Low current output	
			High current output	
			Analog out 2	Data types
				Output format
				Low voltage standard
				High voltage standard
	Low voltage output			
	High voltage output			
	Low current standard			
	High current standard			
	Low current output			
	High current output			
	System 2 tab	Device	Model name	
			Serial number	
			Display soft version	
			Weighing soft version	
			Option port 1	
			Option port 2	
		Date / time	Date set	
			Time set	
		Backup / restoration		
		Operational history		
		USB flash drive	USB operation history	
	USB weighing history			
	Error history			
Connect tab	Modbus	Modbus	Invalid	
		Slave Address	1	
	RS232C	RS-232C port	Invalid	
		RS-232C output format	Cyclic print	
		RS-232C baud rate	2400	
		RS-232C parity	Non	
		RS-232C stop bit	1 bit	
		RS-232C data bit	7 bit	
	RS485	RS-485 port	Invalid	
		RS-485 output format	Cyclic print	
		RS-485 baud rate	2400	
		RS-485 parity	Non	
		RS-485 stop bit	1 bit	
		RS-485 data bit	7 bit	
	LAN	CL IP address		
		CL subnet mask		
		CL default gateway		
WL port		Invalid		
WL IP address				
WL password				
Connection	Printer IP address			

## Part 3/3 of Common Settings List

Common setting window	Connect tab	Monitor	RS-232C	
			RS-485	
			Control I/O	
			Relay out	
			Parallel I/O 1	
			Parallel I/O 2	
			Analog out	

## 9.1. Product Name and Product Code

### 9.1.1. Product Name

---

Input the product name displayed at the **"Weighing window"** and **"Window to select product"**. The product name can input 40 characters in maximum.

### 9.1.2. Product Code

---

Input the product code displayed at the **"Weighing window"** and **"Window to select product"**. The product code can input 40 characters in maximum.

## 9.2. Detect Basis

### 9.2.1. Reject Stage ( Count of Separation )

---

Select 3 stage or 5 stage to the reject stage to classify product.

### 9.2.2. Target

---

Input weight value to the "target value" as standard value of the product.

Refer to the ["5.6.2. Settings of Threshold Values \( Target, HiHi Limit, Hi Limit, Lo Limit, LoLo Limit \)"](#) for the settings.

### 9.2.3. HiHi Limit

---

Input the "HiHi limit value" of the product.

Refer to the ["5.6.2. Settings of Threshold Values \( Target, HiHi Limit, Hi Limit, Lo Limit, LoLo Limit \)"](#) for the settings.

### 9.2.4. Hi Limit

---

Input the "Hi limit value" of the product.

Refer to the ["5.6.2. Settings of Threshold Values \( Target, HiHi Limit, Hi Limit, Lo Limit, LoLo Limit \)"](#) for the settings.

### 9.2.5. Lo Limit

---

Input the "Lo limit value" of the product.

Refer to the "[5.6.2. Settings of Threshold Values \( Target, HiHi Limit, Hi Limit, Lo Limit, LoLo Limit \)](#)" for the settings.

### 9.2.6. LoLo Limit

---

Input the "LoLo limit value" of the product.

Refer to the "[5.6.2. Settings of Threshold Values \( Target, HiHi Limit, Hi Limit, Lo Limit, LoLo Limit \)](#)" for the settings.

### 9.2.7. Over Weight Exception

---

Input value that assumes the product of the "over weight exception" as OK product.

If the "over weight exception" is "effectiveness" and this applicable product is detected, the "over weight exception" indicator  is displayed in the "**Weighing window**".

### 9.2.8. Consecutive Fail Stop

---

The "consecutive fail" is the settings to detect that consecutive defective products occur more than preset count of failed product (of Lo limit, LoLo limit, Hi limit and HiHi limit).

If the settings of consecutive fail is "effectiveness", it can detect.

Refer to the "[9.2.9. Consecutive Fail Num](#)" for count of consecutive defective products.

### 9.2.9. Consecutive Fail Num

---

The "count of consecutive fail" is the settings to input the count of consecutive failed product (of Lo limit, LoLo limit, Hi limit and HiHi limit) that is used to detect consecutive defective products.

## 9.3. Detect Parameter

### 9.3.1. Product Length

---

The "product length" of length of the weighing product is used for detection of "unsplit judge".

### 9.3.2. Speed

---

Input a velocity of the conveyor to the "speed".

### 9.3.3. Weighing Mode

---

The weighing mode can be selected from "passing weighing", "stop weighing" and "static weighing".

#### 1. Passing weighing

The judgement is performed using the "Judge timer" and "Average timer" during a weighing product is passing on the conveyor.

#### 2. Stop weighing

The judgement is performed using the "Judge timer" and "Average timer" after the conveyor is stopped using the "Conveyor stop timer" when the indicator detects that a weighing product is entered on the conveyor. This mode performs judgement of "Two put" and "Unsplit", too.

#### 3. Static weighing

The conveyor is stopped using the "Conveyor stop timer" when the indicator detects that a weighing product is entered on the conveyor. The judgement is performed after the indicator detects stability of a weighing product. This mode performs judgement of "Two put" and "Unsplit", too.

### 9.3.4. Conveyor Stop Timer

---

The "Conveyor stop timer" for the weighing product stores a time from entering on the conveyor to stopping when the "Stop weighing" or "Static weighing" is used.

$$0 < \text{Conveyor stop timer (sec.)} < \frac{\text{Length of conveyor (mm)} - \text{Length of weighing product (mm)}}{\text{Velocity of conveyor (m/min)}}$$

### 9.3.5. Product Detection

---

The "Product detection" specifies a method of the detection.  
Choose a method from "Photo eye sensor" and "Near zero".

#### 1. Photo eye sensor

When the weighing product enters on the conveyor and the photo eye sensor is shaded, it regards as a weighing product is detected.

#### 2. Near zero

When the weighing product enters on the conveyor and the weighing value rises above threshold value of zero point range, it regards as a weighing product is detected.

#### Cautions

- The "Unsplit" cannot judge because the product length cannot identify.
- It is necessary that displays once the weighing value within near zero so as to detect next weighing product after last weighing product enters on the conveyor.
- "Two put" may judge correctly. ( Next weighing product cannot detect during last weighing product leaves on the conveyor. When the weighing value is decided and the detection can be effectiveness, if the vibration of releasing the product from the conveyor is above the threshold value, detection error occurs. etc. )
- Processing rate of the "Near zero" is smaller than "Photo eye sensor".

### 9.3.6. Near Zero Range

---

The "Near zero range" stores a threshold value that weighing value regards as nearly-zero.  
When the weighing value becomes above the threshold value, it means "The start time that weighing product enters on the conveyor".

When the weighing value becomes under the threshold value, it means "The end time that weighing product releases from the conveyor".

### 9.3.7. Auto Mode ( to Set Parameters)

---

The "Auto mode" stores parameters that is automatically calculated when "Filter", "Judge timer" and "Average timer" are effectiveness.

Do not change these parameters except authorized persons.

## 9.4. DO Map (Digital Output Map)

DO map specifies whether stops the conveyor or not in each judgement result. And DO map stores the settings concerning DO output.

Refer to the "5.6.4. Setting the Digital Output (DO)" to how to store the settings of DO map. The output circuit cannot use by the settings of DO map only. Store the settings of the "9.5. Control I/O".

### 9.4.1. DO Map Reference

---

The product number of the same group can be referred concerning the content of DO map and DO behavior. Input a product number of the same group as target of reference. If "0" is inputted, specified reference becomes invalid.

#### Cautions

- Just product number 1 of each group cannot use the function of DO map reference. Additionally, it cannot delete and copy product settings.
- This function is can specify just invalid reference as target of reference. If target product refers other product and/or is not registration, it cannot refer.

### 9.4.2. Output Definition of DO Map

---

OK : It is outputted when last weighing result is within target value.

HiHi : It is outputted when last weighing result is within HiHi limit.

Hi : It is outputted when last weighing result is within Hi limit.

Lo : It is outputted when last weighing result is within Lo limit.

LoLo : It is outputted when last weighing result is within LoLo limit.

Detect Two : It is outputted when next product is entered on the conveyor before last product released from the conveyor.

Unsplit : It is outputted when product length is longer than preset product length.

Metal : It is outputted when DI assigned to metal detection is active.

Ext 1 : It is outputted when DI assigned to external 1 is active.

Ext 2 : It is outputted when DI assigned to external 2 is active.

Belt Running : It is outputted when the conveyor is moving.

Belt Stop : It is outputted when the conveyor is stopped.

Consecutive Fail : It is outputted when an error of consecutive defective products occurs.

Emergency Stop On : It is outputted when DI assigned to emergency stop is active.

Weighing Error : It is outputted when last weighing result is value above capacity (+over) or negative value (-over).

Photo Eye Sensor Error : It is outputted when an error occurs to photo eye sensor.

Bin Full : It is outputted when full capacity is detected.

Air Pressure : It is outputted when DI assigned to air pressure error is active.

Total Num Count : Total number count is outputted when total number in the number of samples summary reaches to preset number.

OK Item Count : Confirmation item count is outputted when total number in the number of OK samples summary reaches to preset number.

Reject Confirmation : It is outputted when an error occurs at confirmation to release product from the conveyor.

Reject Photo Eye Sensor : It is outputted when an error occurs to photo eye sensor used for confirmation to release product from the conveyor.

FC+ : It is outputted when pulse width of feedback control (FC) is positive.

FC- : It is outputted when pulse width of feedback control (FC) is negative.

+zone 1 : It is outputted when the average weighing value calculated with the 10 stage control function is within +zone 1.

+zone 2 : It is outputted when the average weighing value calculated with the 10 stage control function is within +zone 2.

+zone 3 : It is outputted when the average weighing value calculated with the 10 stage control function is within +zone 3.

+zone 4 : It is outputted when the average weighing value calculated with the 10 stage control function is within +zone 4.

+zone 5 : It is outputted when the average weighing value calculated with the 10 stage control function is within +zone 5.

-zone 1 : It is outputted when the average weighing value calculated with the 10 stage control function is within -zone 1.

-zone 2 : It is outputted when the average weighing value calculated with the 10 stage control function is within -zone 2.

-zone 3 : It is outputted when the average weighing value calculated with the 10 stage control function is within -zone 3.

-zone 4 : It is outputted when the average weighing value calculated with the 10 stage control function is within -zone 4.

-zone 5 : It is outputted when the average weighing value calculated with the 10 stage control function is within -zone 5.

### Cautions

- The judgement of highest priority is applied for each weighing.

Example : When "Detect two", "Metal" and "Lo" is occurred at the same time, judgement is applicable as "Detect two" if the priority of the external input is invalid or as "Metal" if the priority is effectiveness, either judgement is outputted. Additionally, the output of "Metal" is continued until "Detect tow" is cleared if the external input is effectiveness.

### Note

- The priority list of judgement are the following 2 types.
- Rank "1" is highest priority.
- Refer to "9.14.6. Connect Device Priority " to how to change priority.

Priority	The priority of the external input is "invalid".	The priority of the external input is "effectiveness"
1	Detect tow	Ext 1
2	Unsplit	Metal
3	Ext 1	Ext 2
4	Metal	Detect tow
5	Ext 2	Unsplit
6	LoLo	LoLo
7	Lo	Lo
8	HiHi	HiHi
9	Hi	Hi
10	OK	OK

- The settings of Modbus can be assigned each 8 byte (4 byte upper figures, 4 byte lower figures) as the followings. Set to "1" against to assigned bit.

Upper 4 byte		Lower 4 byte	
Bit	Description	Bit	Description
MSB 31	0	MSB 31	0
30	-zone 2	30	0
29	-zone 1	29	0
28	+zone 5	28	0
27	+zone 4	27	0
26	+zone 3	26	0
25	+zone 2	25	0
24	+zone 1	24	0
23	FC-	23	0
22	FC+	22	0
21	Reject photo eye sensor	21	0
20	Reject confirmation	20	0
19	OK item count	19	0
18	Total number count	18	0
17	Air pressure error	17	0
16	Bin full	16	0
15	Photo eye sensor error	15	0
14	Weighing error	14	0
13	Emergency stop	13	0
12	Consecutive fail	12	0
11	Belt stop	11	0
10	Belt running	10	0
9	Ext 2	9	0
8	Ext 1	8	0
7	Metal	7	0
6	Unsplit	6	0
5	Detect tow	5	0
4	LoLo	4	0
3	Lo	3	0
2	Hi	2	-zone 5
1	HiHi	1	-zone 4
LSB 0	OK	LSB 0	-zone 3

MSB : Most significant bit, High-order bit.

LSB : Least significant bit, Low-order bit.

Example : When you assign "Bet running", "Unsplit", "Detect two", "-zone 5" and "-zone 3" to DO1, the settings is shown below.

Specify  $2^{10} + 2^6 + 2^5 = 1120$  to upper 4 byte.

Specify  $2^2 + 2^0 = 5$  to lower 4 byte.

Therefore, input 1120 into address 40271 and 5 into address 40273 using each 4 byte access.



## 9.5. Control I/O (Part of Digital Output)

### 9.5.1. DO Behavior

---

This section describes the settings of DO behavior. DO : Digital Output.

#### 1. Hold Time

The "Hold time" to maintain ON or OFF state of DO can be controlled.

ON state of DO can be maintained for "Hold time" after delay time.

When "DO start flag" is turned on during last output, timer is reset and output is maintained.

When the flag is turned on during changing product and the settings of product, the output is turned OFF forcibly.

#### 2. Next Weighing

ON state of DO is maintained from turning on it to the start time of next weighing (detection of rising edge of photo eye sensor). Do not overlap the "start trigger of next weighing" with delay processing.

#### 3. Next Judgement

When DO turns to ON state, it is maintained until the end of judgement.

#### 4. Dialog Box

When DO turns to ON state, it is maintained until the indicator receives a command to turn off it.

When weighing is stopped, DO is maintained until dialog box is hidden. The output is maintained during changing product and the settings of product.

### 9.5.2. Delay Time

---

"Delay time" is time length from judgement to signal output of DO.

Refer to the "[5.6.5. Setting the Delay Time and Holding Time](#)" for the settings.

#### Cautions

- "Delay time" may include jitter of approximately 50 ms. Make enough time length.

### 9.5.3. Hold Time

---

"Hold time" is time length of outputting DO signal.

Refer to the "[5.6.5. Setting the Delay Time and Holding Time](#)" for the settings.

#### Cautions

- "Hold time" may include jitter of approximately 50 ms. Make enough time length.

### 9.5.4. Polarity

---

"Polarity" can specify either positive logic or negative logic.

Positive logic : When a signal is outputted from DO, "A-contact (arbeit contact)" of the relay makes a contact. The settings of Modbus is set to "0".

Negative logic : When a signal is outputted from DO, "B-contact (break contact)" of the relay makes a contact. The settings of Modbus is set to "1".

## 9.6. Statistics

### 9.6.1. Num of Samples

---

Number of samples is used to totalization of control chart, number of OK samples.  
Input range : 2 to 9999 (it is amount of samples or more)

### 9.6.2. Sub Samples

---

Number of averaging when control chart is created.  
Input range : 2 to 10

### 9.6.3. $\bar{\bar{X}}$

---

Center line (CL) for creating  $\bar{X}$  control chart.  
 $\bar{X}$  control chart is displayed using this value when  $\bar{\bar{X}}$  is not 0.

### 9.6.4. $\bar{R}$

---

Center line (CL) for creating  $R$  control chart.  
 $R$  control chart is displayed using this value when  $\bar{R}$  is not 0.

### 9.6.5. Width of Section

---

The range of histogram.  
It is reset when width of section is changed.

## 9.7. Tare

Tare value is used to display net value of product.

Refer to the "5.6.7. Setting a Tare Value" to set tare value.

## 9.8. Auto Zero

The automatic zero adjustment is the function to assign averaging value of weighing value for a averaging time to zero value if adapting to all conditions of "auto zero range", "dead zone timer" and "observation timer" during conveyor is moving.

When the "auto zero" function is "enable", this function is performed.

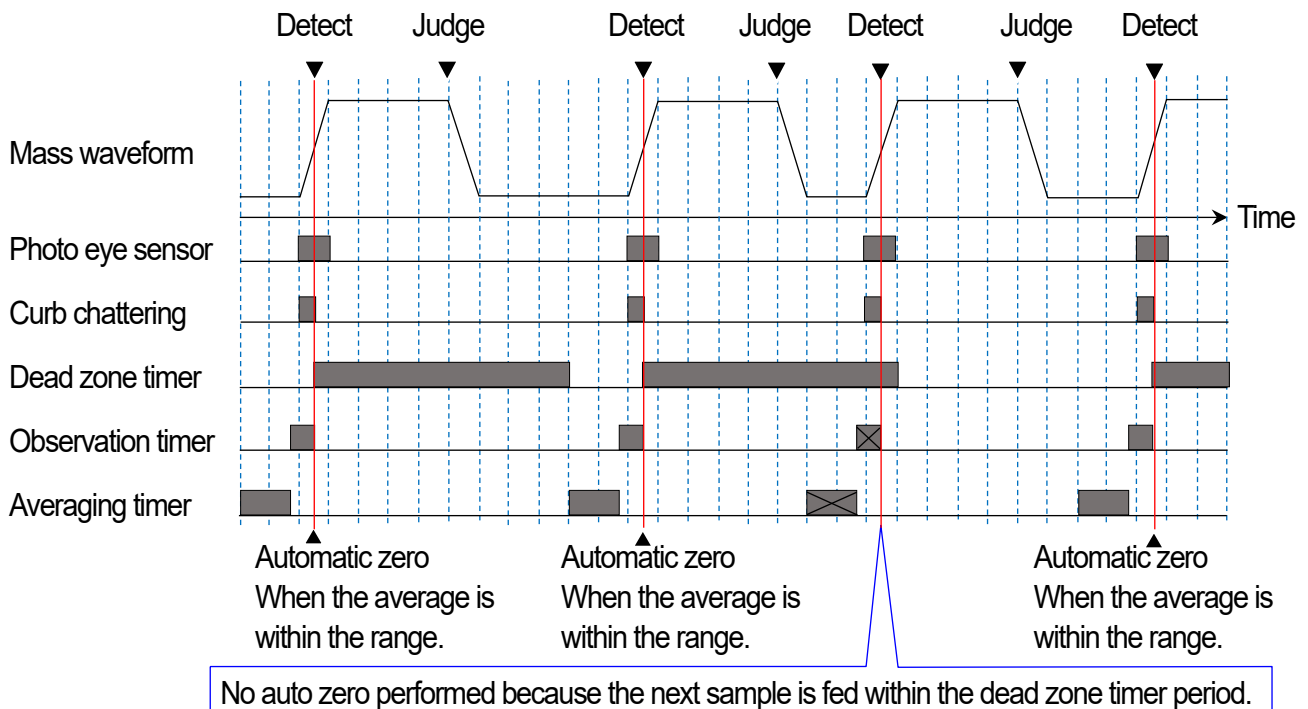

Drawing 72 Automatic zero timing chart

### 9.8.1. Auto Zero Range

The range to perform the function of automatic zero adjustment.

When the range is "0.01" or larger, the function is effective. If weighing values are within this range for averaging time, averaging value of weighing values is assigned to zero.

### 9.8.2. Dead Zone Timer

Dead zone timer store time width to inhibit automatic zero adjustment after automatic zero adjustment.

Example :

If 5 seconds is specified, automatic zero adjustment does not work for 5 second.

### 9.8.3. Observation Timer

---

The settings to inhibit automatic zero adjustment before loading product so that can perform automatic zero adjustment with stable weighing value.

**Example :**

If a timing to load on the conveyor like package is not detected clearly (like product loads on the conveyor before detection of photo eye sensor), it specifies so as not to perform automatic zero adjustment with unstable weighing value.

### 9.8.4. Averaging Time

---

The averaging time of weighing value using automatic zero adjustment.

### 9.8.5. Auto Zero Sample

---

The count to calculate average of automatic zero adjustment.

When number of automatic zero adjustment reaches this count, zero compensation value is replaced to these averaging value.

**Example :**

If count is set to 3, when each zero adjustment are 1 g, 2 g, 3 g, compensation value of zero point is  $(1 + 2 + 3)/3 = 2$  g.

### 9.8.6. Coe (Coefficient)

---

The coefficient against to compensation value at automatic zero adjustment.

Range : 1.0 to 100.0

**Example :**

If coefficient is 50 % and compensation value is 5 g, corrected compensation value is 2.5 g.

## 9.9. D. Comp. Value

The dynamic compensation value of automatic zero adjustment.

Range : 0.5 to 2.0



### 9.10.1. Feedback Control Target

---

The mass value as target value of feedback control (FC).  
When target value of feedback control is "0.01" or more, this function is effective.

### 9.10.2. Feedback Control Range

---

The range used averaging calculation of feedback control (FC).  
The center value of the range is target value of feedback control.

### 9.10.3. Feedback Control Step : [g/sec.] or [sec./g]

---

The parameter to specify pulse width in unit of [g / sec.] or [sec. / g] . If one is decided, the other is also calculated automatically.  
Range : 0.01 to 1 [sec. / g] (1 to 100 [g / sec.] )

### 9.10.4. Feedback Control Sample

---

The number of times that is used to averaging of weighing value for the judgement of this difference.  
Range : 1 to 9999 [times]

### 9.10.5. Feedback Control Waiting Time

---

Waiting time until averaging is start after feedback control is outputted.  
Range : 0 to 999 [seconds]

## 9.11. Step Control

The function of 10 stage control judges weighing value based on the settings and outputs to DO (digital output). This function is used for DO and does not affect to summary.

### Note

- Refer to "9.4. DO Map" for details of DO.
- Refer to "9.5. Control I/O" for delay time and Hold time of DO.

The procedure to use 10 stage control is as follows :

- Step 1. Specify waiting time after detecting first product on the conveyor when weighing is started.
- Step 2. Weighing value are averaged using number of times for the averaging after this detection.
- Step 3. Average weighing value is judged using threshold values, zones after averaging.
- Step 4. DO is outputted using DO delay time and hold time based on DO map.
- Step 5. Return to step 1 and repeat procedure.

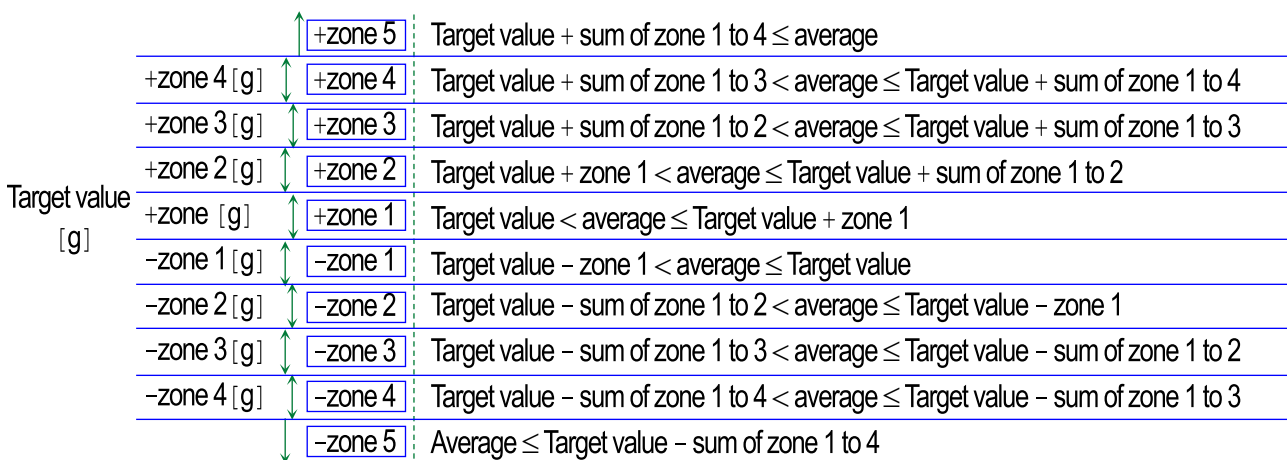

Drawing 74 10 stage control function

### 9.11.1. Control Target

The step control uses threshold values used at judgement of 10 stage control.

### 9.11.2. Zone 1 to 4 of 10 Stage Control

---

The settings of zone is used to judge weighing value on 10 stage control.  
The initial values of zone are 0 g at factory settings.  
Each total value of zone is total value from zone 1 to applicable zone.

**Example :**

If the setting value of zone 1 is 10.0 g and the setting value of zone 2 is 20.0 g,  
total value of zone 2 is 10.0 g + 20.0 = 30.0 g.

10Stage Control Setting1		10Stage Control Setting2	
Control Target		0.00	g
Zone1	Total Sum 0.00	0.00	g
Zone2	Total Sum 0.00	0.00	g
Zone3	Total Sum 0.00	0.00	g
Zone4	Total Sum 0.00	0.00	g
10C Sample		1	pcs

Drawing 75 10 stage control function window

### 9.11.3. 10 C Sample

---

The number of times to average weighing value that is used to judgement of 10 stage control.  
Range : 1 to 9999 [times]

### 9.11.4. 10 C Wait Time

---

Waiting time from DO (digital output) of 10 stage control to start time of next averaging.  
Range : 1 to 999 [seconds]



## 9.12. Weighing

### 9.12.1. Unit

---

A weighing unit can select from kg, g, lb and oz.

If the law in your area permits, you may use all of the units. lb and oz can be used in U.S.A. version.

#### Cautions

- If the current unit is changed, summary of totalization is reset.

### 9.12.2. Decimal Point

---

The position of decimal point is 0, 0.0, 0.00, 0.000 and 0.0000.

This indicator uses point (Dot) for format of decimal point.

### 9.12.3. Division

---

The readability of weighing value uses 1, 2, 5, 10, 20, and 50.

### 9.12.4. Capacity

---

The weighing capacity is maximum value that this indicator can display.

### 9.12.5. Digital Filter

---

Digital filter at stopping the conveyor uses a cutoff frequency to suppress drift of weighing value. When low frequency is used, drift decreases and response becomes slow.

Cutoff frequency : 7, 10, 14, 20, 28, 40, 56, 80, 110, None [Hz]

### 9.12.6. Zero Point Range

---

Touch the "Zero" key  on the "weighing window" to input an adjustable range of zero point using ratio against to capacity.

#### Example :

If capacity is 10000 g and range of zero point is 2 %,  $\pm 200$  g is adjustable range of zero point.

### 9.12.7. Power on Auto Zero Range

---

When indicator turns on, specify a range of automatic zero adjustment using ratio against to the capacity.

#### Example :

If capacity is 10000 g and range of zero point is 10 %,  $\pm 1000$  g is adjustable range of zero point when turning on.

### 9.12.8. Zero Tracking Time

---

The zero tracking is a function to display automatically zero while the conveyor stops. Zero tracking time is time range to perform this function. If gross weighing values are within a weighing range (zero tracking weight) during time range (zero tracking time), the zero tracking function is performed and 0 is displayed.

### 9.12.9. Zero Tracking Weight

---

The zero tracking weight specifies weighing range to perform zero tracking function.

When zero tracking weight is set to "None", the function does not perform.

If weighing value is within zero tracking weight for zero tracking time when the conveyor stops, the function is performed and 0 is displayed.

Zero tracking weight: 0.5, 1.0, 1.5, 2.0, 2.5, 3.0, 3.5, 4.0, 4.5, None [digit]

**Example :**

If zero tracking weight is 1.0 digit and zero tracking time is 3 seconds, when gross weighing value is within  $0 \pm 1.0$  digit for 3 second, the zero tracking function is performed and 0 is displayed.

### 9.12.10. Stability Time

---

Time range to be used on the stability detection function.

### 9.12.11. Stability Weight

---

Range of weighing value to be used on the stability detection function.

Zero tracking weight : 1, 2, 3, 4, 5, 6, 7, 8, 9, None [digit]

## 9.13. Cal (Calibration)

Refer to the "[6.1. Calibrating the Indicator using a Weight](#)" for adjustment procedure.

### 9.13.1. Weight

---

A value of weight used for adjustment can input value between 0 g and capacity of load cell in unit of gram.

### 9.13.2. Zero Point

---

Zero point value is a base point of weighing. Unit is mV / V.

### 9.13.3. Span

---

Value of the adjustment weight in unit of mV / V.

## 9.14. Main Unit

### 9.14.1. Identification Name

---

Identification name uses to find this indicator from multiple devices.  
Identification name can use up to 40 characters.

### 9.14.2. Start up User Level

---

Management user can specify a management level of automatic login user at turning on the indicator.

Management level of user : "Operator", "Supervisor", "Quality manager" and "Administrator"

#### Cautions

- Management level of management user needs "Administrator".
- Management user can only change management level. The settings of user cannot change.

### 9.14.3. Conveyor Length

---

This length means length of weighing conveyor.

#### Cautions

- If the length is changed, this update needs time because the whole parameters of judgement are calculated.
- When update has finished, restart of the indicator needs.

### 9.14.4. Unsplit Range

---

Tolerance value of unsplit can specify in ratio (%) against to product length.

### 9.14.5. Conveyor Mode

---

The conveyor mode moves only the conveyor without weighing.

If conveyor mode is "enable", it is performed and cannot change the settings.

### 9.14.6. Connect Device Priority

---

If an external input is specified to priority input, external signal inputted to DI has priority.

#### Note

Refer to ["9.4.2. Output Definition of DO Map"](#) for priority order of judgement.

### 9.14.7. Curb Chattering

---

Duration time can be specified to prevent curb chattering of the photo eye sensor.

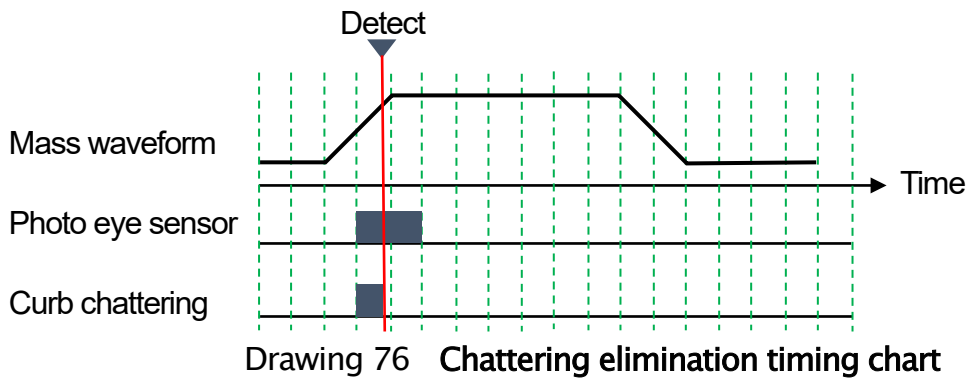

### 9.14.8. Photo Eye Sensor Polarity

---

Output of photo eye sensor can be selected either positive logic or negative logic.

### 9.14.9. Photo Eye Sensor Timeout

---

Timer to detect shading error of photo eye sensor.

If light of photo eye sensor is shaded longer than this preset time, it regards as photo eye sensor error.

Range : 0.1 to 99.0 [seconds]

### 9.14.10. Random Check (To input data previously)

---

Random check is the function that can shorten reading time by inputting product settings of the same group at turning on the indicator.

#### Cautions

- If the random check function is changed to effective, restart the indicator to use it.

## **9.15. Display**

### **9.15.1. Language**

---

Language can specify either Japanese or English.

### **9.15.2. Display Mode**

---

The display method of weighing mode is shown below.

#### **1. Weighing Result**

Weighing result is only displayed.

#### **2. The Current Weighing Value**

The current weighing value of the conveyor is displayed.

### **9.15.3. Negative Weight**

---

The selection either displaying negative weighing value or not.

If display mode of weighing value is "Current value" and "Not displayed", the display of the indicator is blank when weighing value is negative.

### **9.15.4. Display Data**

---

Data displayed on weighing monitor in the indicator can be specified. When the conveyor is moving, it cannot change.

### **9.15.5. Standby Mode**

---

The waiting mode is the function to hide the display of the indicator if operation is not during preset time of standby mode.

Store time until standby mode is started.

### **9.15.6. Brightness**

---

Specify brightness of display on the indicator.

## **9.16. Connection**

### **9.16.1. Printer IP Address**

---

Specify an IP address for the printer connecting to the indicator.

## 9.17. DI Map (Digital Input Map)

DI map is used when "Reject check", "Approve check" and "Reject + Approve" are assigned. The checked item of "Reject check" and "Approve check" can be confirmed.

In "Reject + Approve", item of "Approve check" can be confirmed when item is checked, item of "Reject check" can be confirmed when item is not checked.

Refer to the "9.18. Control I/O (Part of Digital Input)" concerning of "Reject check", "Approve check" and "Reject + Approve".

## 9.18. Control I/O (Part of Digital Input)

The timing chart of DI is shown below. DI : Digital input.

The pulse width of DI needs "duration time to prevent chattering" + 50 ms or more.

Processing of judgement is performed when sample is released from the conveyor.

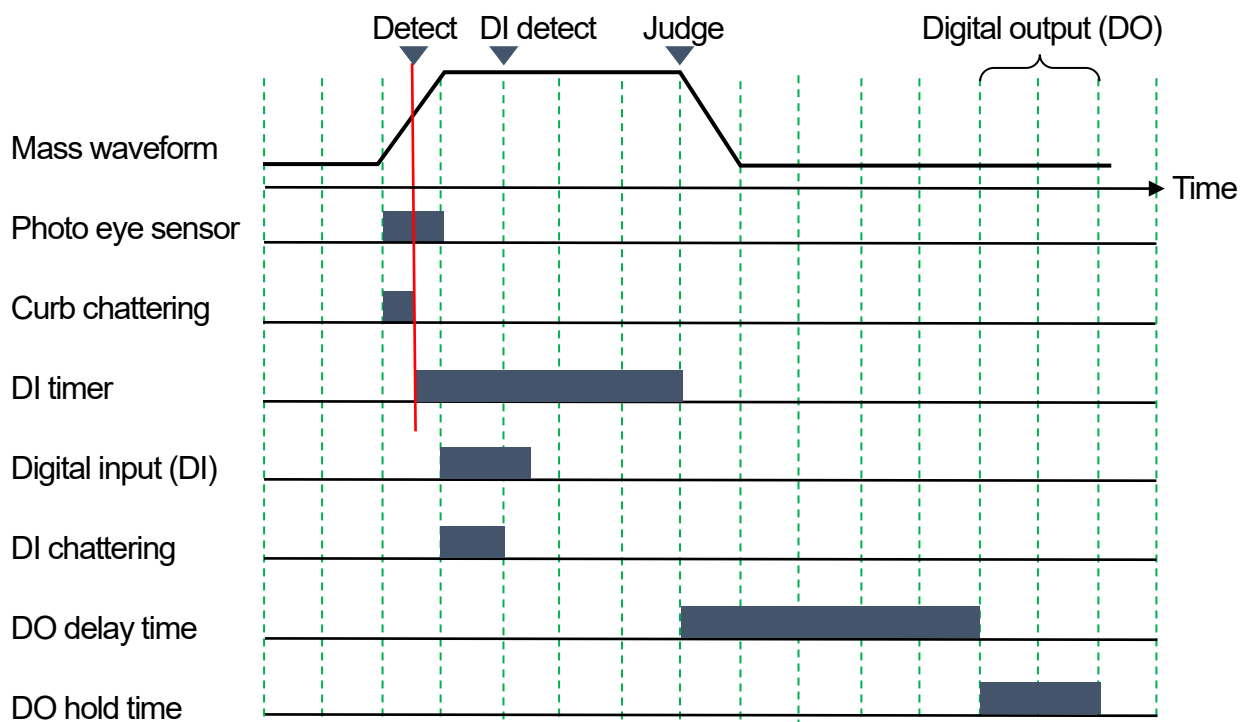

Drawing 77 DI/DO timing chart

2019/05/17 16:57 No: 01-001 User:Administrator USB

DI1-DI4	DI5-DI8	DI9-DI11
D11	Rising Edge	Disable
	0.00 sec	0.00 sec
D12	Rising Edge	Disable
	0.00 sec	0.00 sec
D13	Rising Edge	Disable
	0.00 sec	0.00 sec
D14	Rising Edge	Disable
	0.00 sec	0.00 sec

Drawing 78 DI window

## 9.18.1. Input Trigger

The input trigger can be select from "Rising edge", "Falling edge", "Both edge", "High level" and "Low level" at pull-down menu. These actions are shown below.

### 1. Rising Edge

The method to regard as input trigger when rising edge ( $0 \rightarrow 1$ ) of the input is detected. Next trigger can detect after the input becomes 0 once.

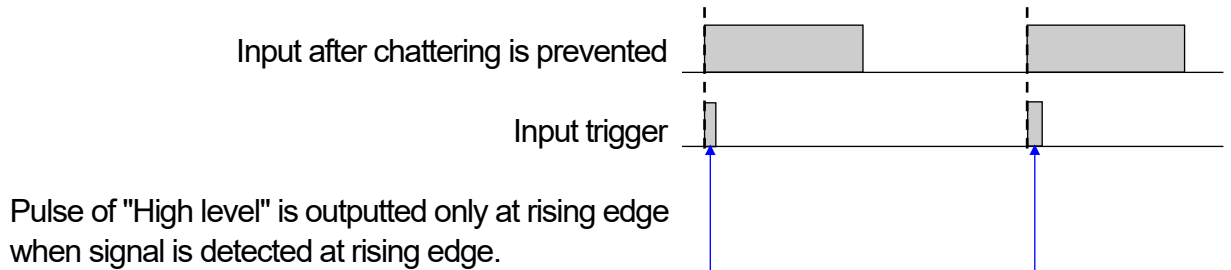

Drawing 79 Input trigger by rising edge

### 2. Falling Edge

The method to regard as input trigger when falling edge ( $1 \rightarrow 0$ ) of the input is detected. Next trigger can detect after the input becomes 1 once.

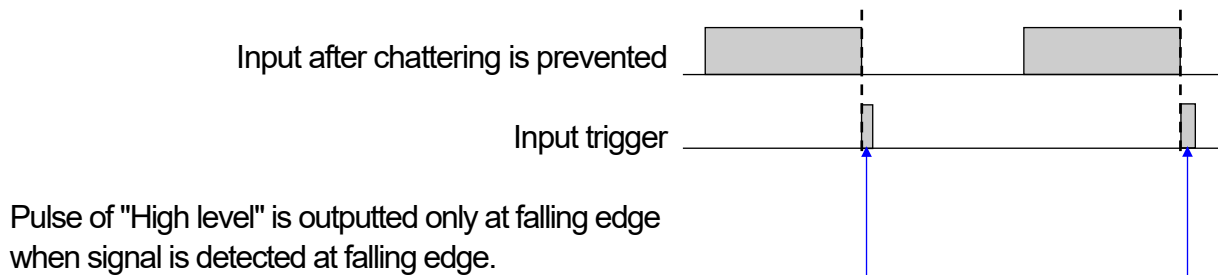

Drawing 80 Trigger input by falling edge

### 3. Both Edge ( Rising Edge and Falling Edge)

The method to regard as input trigger when both rising edge ( $0 \rightarrow 1$ ) and falling edge ( $1 \rightarrow 0$ ) of the input are detected.

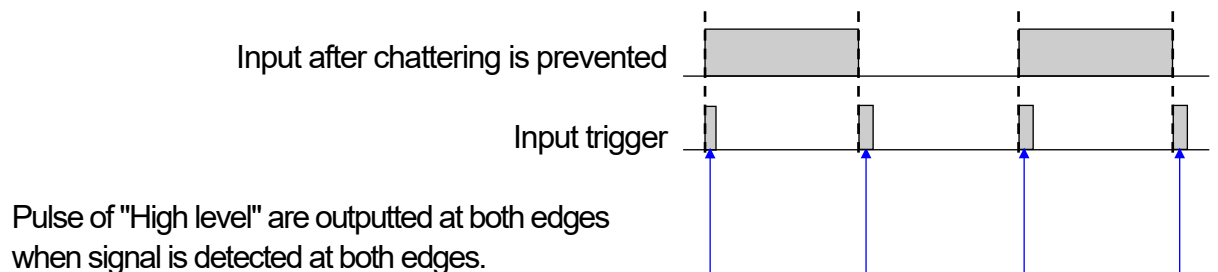

Drawing 81 Trigger input by both edge ( rising edge and falling edge)



#### 4. ON Level

The method to regard the input level from rising edge ( $0 \rightarrow 1$ ) to falling edge ( $1 \rightarrow 0$ ) as input trigger.

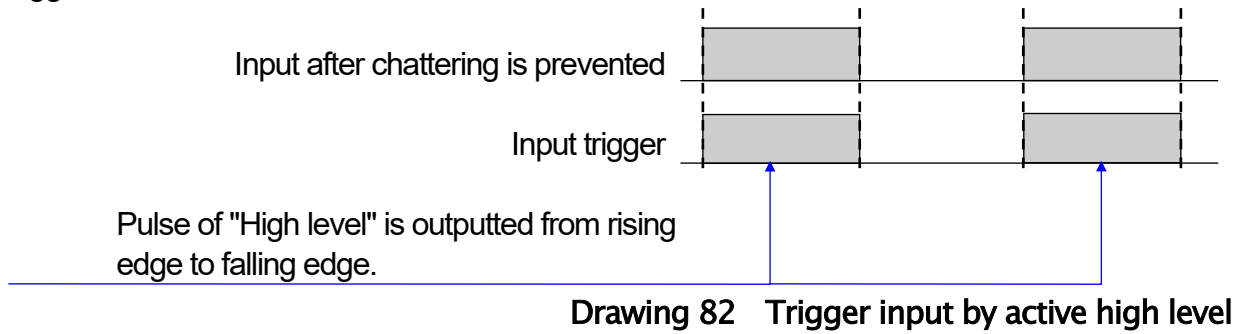

#### 5. OFF Level

The method to regard the input level from falling edge ( $1 \rightarrow 0$ ) to rising edge ( $0 \rightarrow 1$ ) as input trigger.

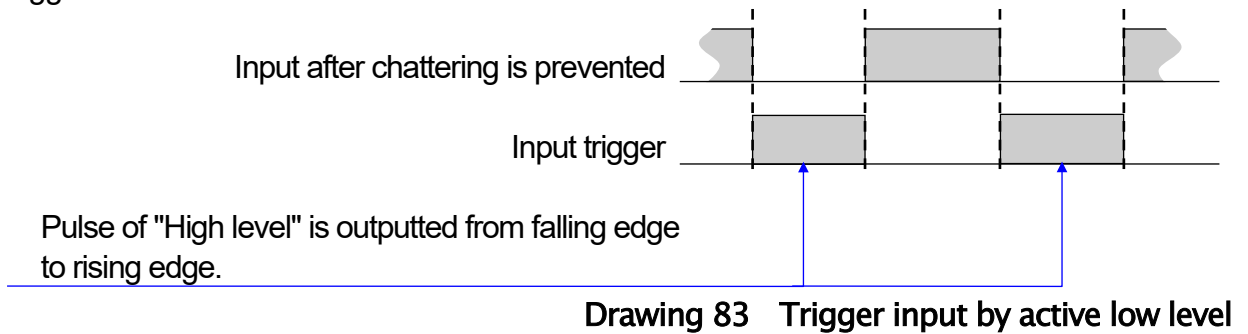

## 9.18.2. Configuration

---

The function of each DI can specify using pull-down menu.  
Available functions are shown below.

### 1. Disable

The content means "no function". The setting value of Modbus is 0.

### 2. Weighing Start

To assign a signal of weighing start. The setting value of Modbus is 1.

### 3. Weighing Stop

To assign a signal of weighing stop. The setting value of Modbus is 2.

### 4. Start/Stop

To assign a signal of weighing start and weighing stop. When this signal is high level (low level), weighing is started. When this signal is low level (high level), weighing is stopped. input trigger uses both edges always. The setting value of Modbus is 3.

### 5. Stop Release

To assign a signal to hide dialog box from peripherals if dialog box is displayed when judgement and error is detected. The setting value of Modbus is 4.

### 6. Summary Clear

To assign a signal to delete summary. The setting value of Modbus is 5.

### 7. Ext 1

To assign a signal of Ext 1. The setting value of Modbus is 6. Ext 1 : External 1.

### 8. Ext 2

To assign a signal of Ext 2. The setting value of Modbus is 7. Ext 2 : External 2.

### 9. Metal

To assign a signal of Metal detection. The setting value of Modbus is 8.

### 10. Air Pressure Error

To assign a signal of Air pressure error. The setting value of Modbus is 9.

### 11. Bin Full

To assign a signal of Bin full. Bin full is the function to inform that discharge box (like hopper) is full capacity. The setting value of Modbus is 10.

### 12. Emergency Stop

To assign a signal of Emergency stop. When a signal of emergency stop is inputted, the conveyor is stop immediately. While a signal of emergency stop is inputted, the conveyor stops. The setting value of Modbus is 11.

### 13. Reject Check

To assign a signal of "Reject check". The setting value of Modbus is 12.

"Reject check" is the function to inspect an error that weighing matter except target product passes using photo eye sensor that is placed at releasing side of the rejector on conveyor line. Timing chart of "Reject check" is shown below.

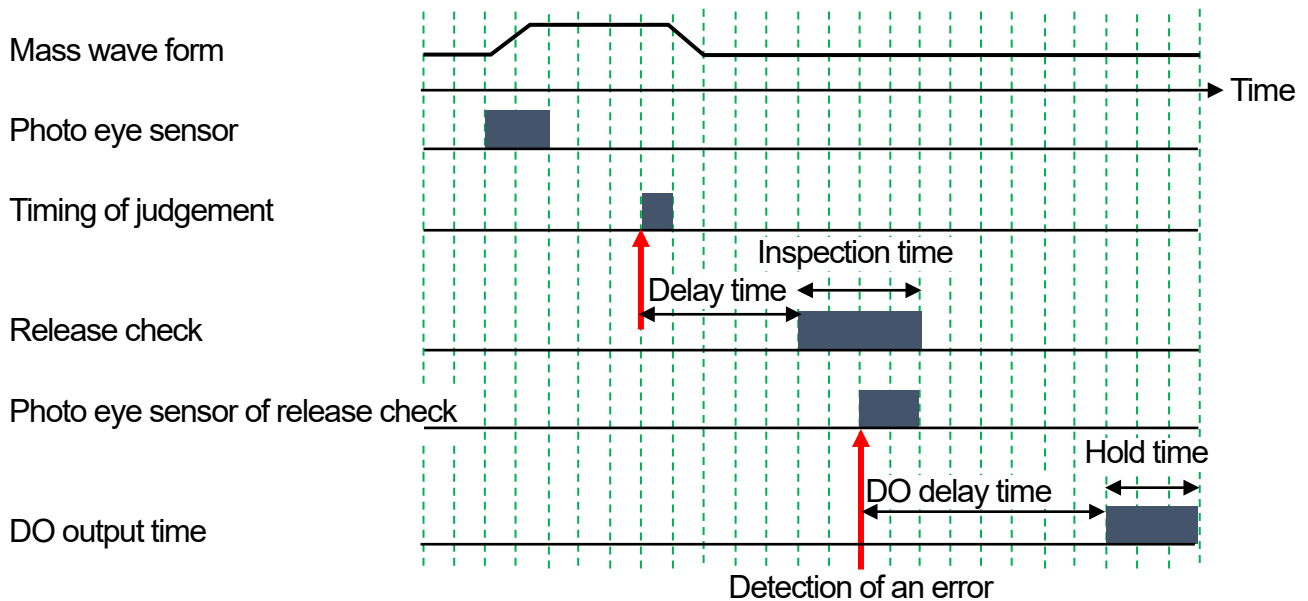

**Drawing 84 Timing chart to confirm releasing**

Example of timing chart is detected product to be judged as "over weight" using photo eye sensor of release side.

After weighing judgement, Hold time of length of product can be specified after delay time.

If photo eye sensor of release side is from OFF to ON during inspection time, it is judged as releasing error.

In example, photo eye sensor of release check is held to ON because the conveyor stops.

if "Reject confirmation" is assigned to DO and it is judged, DO is outputted during DO hold time after DO delay time.

Delay time T can be calculated using distance Ld from the end of conveyor to detection position of photo eye sensor and the conveyor velocity V.

$$T = Ld / V$$

Use as approximate value and adjust value using measurement.

Release check time t1 is calculated using length of weighing belt Lv and conveyor velocity V.

$$t1 = (Lv \times 0.8) / V$$

In judgement of "Detect two", the inspection time t is calculated regard plural products as product length. If photo eye sensor of release check is ON longer than preset value during operation, it is judged as error of photo eye sensor, the conveyor stops and error is displayed.

### 14. Approve Check

To assign a signal of "Approve check". The setting value of Modbus is 13.

"Approve check" is the function to confirm that product passes correctly using photo eye sensor that is placed at release side in the regular direction on conveyor line.

Timing chart of "Approve check" is shown below.

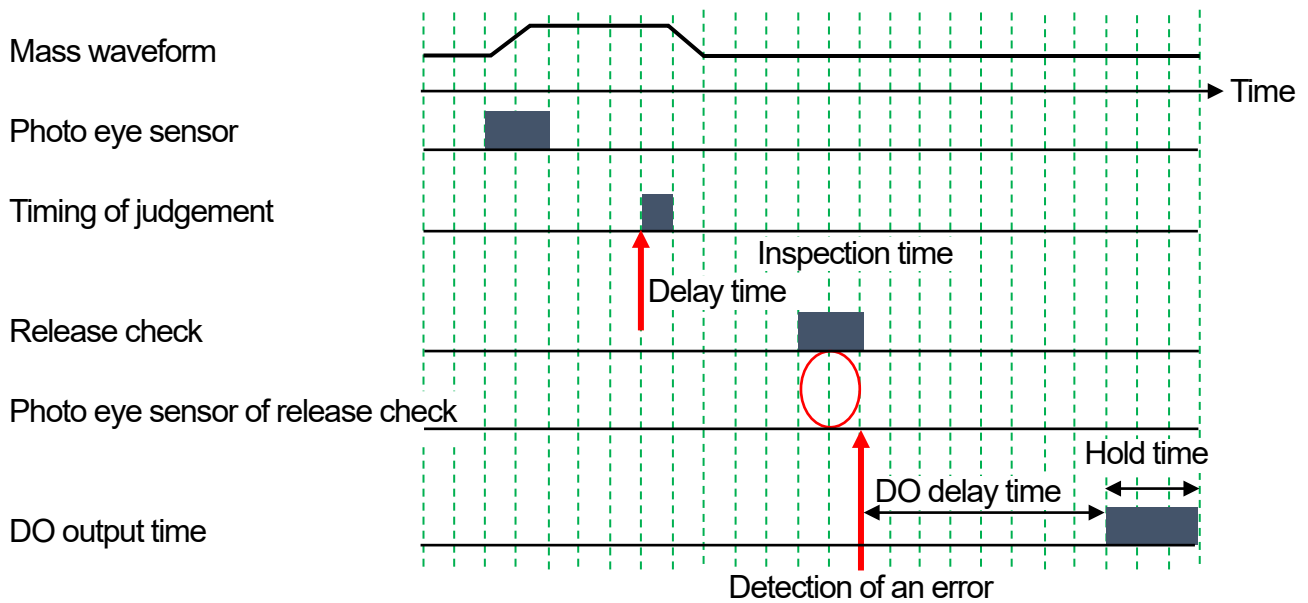

**Drawing 85 Timing chart when (correct product) is passing**

First timing chart is a sample that OK product does not pass correctly.  
 After weighing judgement, Hold time of length of product can be specified after delay time.  
 If photo eye sensor of release check is not ON during inspection time, it is judged as passing error.

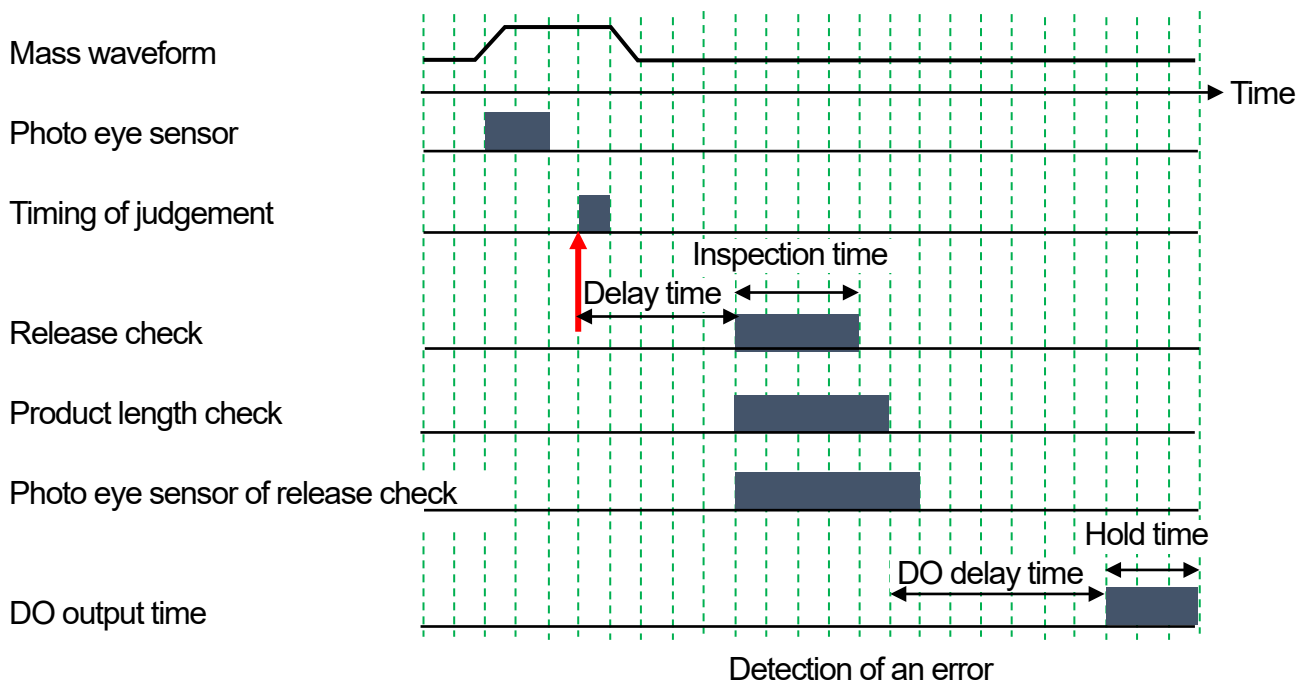

**Drawing 86 Timing chart when (long product) is passing**

Second timing chart is a sample that OK product shades light of photo eye sensor longer than time of product length check. After weighing judgement, Hold time of length of product can be specified after delay time. If light of photo eye sensor is shaded longer than check time of product length, it is judged as passing error.

Check time of product length  $t_2$  is calculated using length of product  $L_p$  and conveyor velocity  $V$ .  
 $t_2 = (L_p \times 1.5) / V$

If "Reject confirmation" is assigned to DO and it is judged, DO is outputted during hold time after delay time. Judgement of "Delay time" and "detect two" are the same as "Release check".

## Cautions

- "Detect two" cannot judge each product because judgement is one section.
- In stopped weighing and stable weighing, If first product is OK weighing product and second product is judged to "detect two", release of first product cannot confirm because both product is near place on conveyor during second product is weighed.

### 15. Reject + Approve

It is used when "Reject check" and "Approve check" are performed using one photo eye sensor. Place the photo eye sensor at release side in regular direction on conveyor line. The setting value of Modbus is 14.

### 16. Photo Eye Sensor

To assign photo eye sensor. Chattering time is the same as time to prevent chattering. The setting value of Modbus is 15.

### 17. Forced Operation, DO1 to DO11

DO can use forced. The setting value on Modbus is 16 to 26 of DO1 in order.

---

## 9.18.3. Delay Time

Delay time of DI1 to DI11 are specifies.

This function uses when connected peripherals needs delay time.

Tune delay time so as to receive signal of peripherals within receiving time in DI timing chart.

DI assigned to "Reject check" is time from weighing judgement to "Reject check".

---

## 9.18.4. Chattering

Time to prevent chattering to DI1 to DI11 can be input.

## 9.19. DI Indicator

The DI indicator is the function to monitor input signals form peripherals.

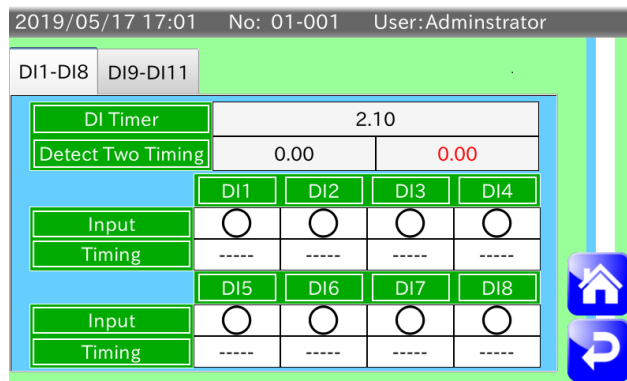

Drawing 87 DI indicator window

### 1 DI Timer

The receiving time of DI can be specified.

### 2 Detect Two Timing

Time from shading of photo eye sensor of last weighing to shading of photo eye sensor of next weighing.

If judgement is except "Detect two", time (black) in left side of "Detect two" is updated.

If judgement is "Detect two", time (red) in right side of "Detect two" is updated.

If many "Detect two" occurs, check these timing and arrange the velocity etc.

### 3 Input

Each status of DI is not affected effect of delay time and is displayed at real time.

ON is ● . OFF is ○ .

### 4 Timing

Input timing displays time from the starting of receiving to input signal.

Timing to be affected effect of delay time is reflected to the input timing.

Input timing is reflected the timing affected by delay time.

If input timing is within receiving time, it is displayed with black characters.

If input timing is not within receiving time, it is displayed with red characters. Adjust input timing using delay time with considering variation of input signal.

### The Adjustment of Input Timing

The procedure to adjust input timing is shown below.

Step 1. Operate the indicator and conveyor.

Step 2. If metal detection device is connected, put test piece on sample. Feed the sample (weighing product) on the conveyor.

Step 3. After sample enters on the infeed conveyor, an input timing is displayed.

When the input timing is black characters, it is correct input.

When the input timing is red characters, adjust it using delay time with considering variation of input signal. Confirm it once again.

## 9.20. Analog Out

The analog output OP-07 can install to option slot which is analog board to output weighing value and velocity data etc. using electric current and voltage. Refer to the "[11.8. OP-07 Additional Analog Output Module](#)".

### 9.20.1. Data Types

---

Data type for analog output can be specified either weight or velocity.

### 9.20.2. Output Format

---

Output format for analog output can be specified either current output or voltage output.

### 9.20.3. Low Voltage Standard

---

Low voltage standard of analog output can be specified from 0 V, 1 V, 2 V.

### 9.20.4. High Voltage Standard

---

High voltage standard of analog output can be specified from 3 V to 10 V.

### 9.20.5. Low Voltage Output

---

Low voltage output of analog output can be set. When output data is value of low voltage, voltage of low voltage standard is outputted.

### 9.20.6. High Voltage Output

---

High voltage output of analog output can be set. When output data is value of high voltage, voltage of high voltage standard is outputted.

### 9.20.7. Low Current Standard

---

Low current standard of analog output can be specified from 4 mA, 5 mA, 6 mA.

### 9.20.8. High Current Standard

---

High current standard of analog output can be specified from 18 mA, 19 mA, 20 mA.

### 9.20.9. Low Current Output

---

Low current output of analog output can be set. When output data is value of low current, current of low current standard is outputted.

### 9.20.10. High Current Output

---

High current output of analog output can be set. When output data is value of high current, current of high current standard is outputted.

## 9.21. Device

Information of the indicator is displayed.

### 9.21.1. Model Name

---

Name of the indicator is displayed.

### 9.21.2. Serial Number

---

Serial number of the indicator is displayed.

### 9.21.3. GUI Software Version

---

Version of software installed in the display panel is displayed.

### 9.21.4. Weighing Software Version

---

Version of weighing software installed in the indicator is displayed.

### 9.21.5. Option Port 1 and 2

---

The information of option board installed in the indicator.

## 9.22. Date / Time

### 9.22.1. Date Set

---

Date (year, month, day) of the built-in clock can be adjusted.  
Refer to the "[6.2. Settings for Date and Time](#)" for adjustment.

### 9.22.2. Time Set

---

Time (hour, minute, second) of the built-in clock can be adjusted.  
Refer to the "[6.2. Settings for Date and Time](#)" for adjustment.

## 9.23. USB Flash Drive

### 9.23.1. USB Operation History

---

Select whether to output operation history when the USB flash drive is connected.

### 9.23.2. USB Weighing History

---

Select whether to output weighing history when the USB flash drive is connected.



## 9.24. Modbus

### 9.24.1. Modbus

---

The settings of Modbus communication.

If the settings is changed, restart the system to use new settings.

Refer to the "[10.3. Communication Command of Modbus](#)" for the details.

The settings is shown below.

- 1 **Disable**  
Modbus is not used.
- 2 **Modbus / RTU**  
Serial communication of Modbus can be used.
- 3 **Modbus / TCP**  
TCP/IP communication of Modbus can be used.

### 9.24.2. Slave Address

---

Specify a slave address of the indicator for Modbus communication.

## 9.25. Output Format

### Note

All characters is used ASCII code.

␣ : Space code, hexadecimal code 0x20.

Terminator <CR><LF> is added to the end of characters.

<CR> : carriage return, 0x0D.

<LF> : Line feed, 0x0A.

### 1. Periodical Print

The periodical print format is consists total number, total judgement, A&D format of data.

The periodical print format is a fixed 24 characters (excluding terminator).

Total number : 5 characters, total judgement : 2 characters, data format : 15 characters.

Output example

1	2	3	4	5	6	7	8	9	10	11	12	13	14	15	16	17	18	19	20	21	22	23	24
0	0	0	0	1	,	O	K	,	S	T	,	+	0	0	0	1	2	.	3	4	5	␣	g
Total number					Judgement			result A&D format															

OK

1	2	3	4	5	6	7	8	9	10	11	12	13	14	15	16	17	18	19	20	21	22	23	24
0	0	0	0	1	,	O	K	,	S	T	,	+	0	0	0	1	2	.	3	4	5	␣	g

HiHi limit

1	2	3	4	5	6	7	8	9	10	11	12	13	14	15	16	17	18	19	20	21	22	23	24
0	0	0	0	1	,	H	H	,	S	T	,	+	0	0	0	1	2	.	3	4	5	␣	g

Hi limit

1	2	3	4	5	6	7	8	9	10	11	12	13	14	15	16	17	18	19	20	21	22	23	24
0	0	0	0	1	,	H	I	,	S	T	,	+	0	0	0	1	2	.	3	4	5	␣	g

Lo limit

1	2	3	4	5	6	7	8	9	10	11	12	13	14	15	16	17	18	19	20	21	22	23	24
0	0	0	0	1	,	L	O	,	S	T	,	+	0	0	0	1	2	.	3	4	5	␣	g

LoLo limit

1	2	3	4	5	6	7	8	9	10	11	12	13	14	15	16	17	18	19	20	21	22	23	24
0	0	0	0	1	,	L	L	,	S	T	,	+	0	0	0	1	2	.	3	4	5	␣	g

2 packages

1	2	3	4	5	6	7	8	9	10	11	12	13	14	15	16	17	18	19	20	21	22	23	24	
*	*	*	*	*	,	T	D	,	*	*	,	*	*	*	*	*	*	*	*	*	*	*	␣	

Double product

1	2	3	4	5	6	7	8	9	10	11	12	13	14	15	16	17	18	19	20	21	22	23	24	
*	*	*	*	*	,	U	S	,	*	*	,	*	*	*	*	*	*	*	*	*	*	*	␣	

External NG1

1	2	3	4	5	6	7	8	9	10	11	12	13	14	15	16	17	18	19	20	21	22	23	24
0	0	0	0	4	,	E	1	,	S	T	,	+	0	0	0	1	2	.	3	4	5	␣	g

External NG2

1	2	3	4	5	6	7	8	9	10	11	12	13	14	15	16	17	18	19	20	21	22	23	24
0	0	0	0	4	,	E	2	,	S	T	,	+	0	0	0	1	2	.	3	4	5	␣	g

Material

1	2	3	4	5	6	7	8	9	10	11	12	13	14	15	16	17	18	19	20	21	22	23	24
0	0	0	0	6	,	M	D	,	S	T	,	+	0	0	0	1	2	.	3	4	5	␣	g



## 9.26. RS-232C

### 9.26.1. RS-232C Port

---

The settings of RS-232C communication are shown below.

- 1. Disable**  
It is the settings when RS-232C communication is not used.
- 2. Dump Print**  
It is the settings to use the dump printer.
- 3. Stream**  
It is the settings to output the current weighing value. The output interval is 200 ms.
- 4. Weighing Result**  
It is the settings to output weighing result when the weighing values have judged.
- 5. Product Change**  
It is the settings to read the product code using the bar code reader etc. and to change to matched product.

### 9.26.2. Output Mode

---

The output format of RS-232C communication is the settings below.

- 1. Cyclic Print**  
This mode is the settings to output using format of periodic printing.
- 2. A&D Format**  
This mode is the settings to output using A&D format.

### 9.26.3. Baud Rate

---

Baud rate of RS-232C communication is the settings below.

Baud rate : 2400, 4800, 9600, 19200, 38400, 57600, 115200 [bps]

### 9.26.4. Parity

---

Parity of RS-232C communication is the settings below.

Parity : None, Even or Odd

### 9.26.5. Stop Bit

---

Stop bit of RS-232C communication is the settings below.

Stop bit : 1 bit or 2 bit

## 9.26.6. Data Bit

---

Data length of RS-232C communication is the settings below.

Data length : 7 bit or 8 bit

## 9.27. RS-485

### 9.27.1. RS-485 Port

---

The settings of RS-485 communication is shown below.

#### 1. Disable

It is the settings when RS-485 communication is not used.

#### 2. Stream

It is the settings to output the current weighing value. The output interval is 200 ms.

#### 3. Weighing Result

It is the settings to output weighing result when the weighing values have judged.

### 9.27.2. Output Mode

---

The output format of RS-485 communication is the settings below.

#### 1. Cyclic Print

This mode is the settings to output using format of periodic printing.

#### 2. A&D Format

This mode is the settings to output using A&D format.

### 9.27.3. Baud Rate

---

Baud rate of RS-485 communication is the settings below.

Baud rate : 2400, 4800, 9600, 19200, 38400, 57600, 115200 [bps]

### 9.27.4. Parity

---

Parity of RS-485 communication is the settings below.

### 9.27.5. Stop Bit

---

Stop bit of RS-485 communication is the settings below.

Stop bit : 1 bit or 2 bit

### 9.27.6. Data Bit

---

Data length of RS-485 communication is the settings below.

Data length : 7 bit or 8 bit

## **9.28. LAN**

### **9.28.1. CL IP Address**

---

IP address of wired LAN can be specified.

CL : Cabled.

### **9.28.2. CL Subnet Mask**

---

Subnet mask of wired LAN can be specified.

### **9.28.3. CL Default Gateway**

---

Default gateway of wired LAN can be specified.

### **9.28.4. WL Port**

---

"Disable" or "Enable" of wireless LAN can be specified.

WL : Wireless.

### **9.28.5. WL IP Address**

---

IP address of wireless LAN can be specified.

### **9.28.6. WL Password**

---

Password of wireless LAN can be specified. Use 8 characters for password.

## 9.29. Monitor

- The indication using the monitor function on the AD-4412-CW are as follows :
  - Terminal status of control I/O.
  - Terminal status of OP-02 relay output.
  - Whole terminal status of OP-05 parallel I/O.
  - Voltage value of OP-07 analog output.
  - Communication data of RS-232C and RS-485. However, while Modbus RTU is specified, communication data of RS-485 becomes ineffective.
- If data rate of DI and DO is faster than refresh rate of the monitor, it may not indicate completely.
- DI is displayed in real time that is not affected to delay time and chattering.
- Output voltage of the analog board may contain error against the indication value.

### 9.29.1. RS-232C

Received data and transmission data are displayed in order of a time series.

Leading 4 characters of data is used to identify either received data or transmission data.

(In case of transmission data, <Tx> is displayed. In case of received data, <Rx> is displayed.)

Regarding of received data, the following process is performed.

- If <CR> is received and next code is not <LF>, carriage return is performed.
- If <LF> is received,
- If transmission data is transmitted during receiving data.
- If control code except <CR><LF> is received, <.> is displayed.

Touch the "Clear" key  to delete data on the text box.

<CR> : Carriage return. Hex code 0x0D.

<LF> : Line feed. Hex code 0x0A.

<.> : Period. Hex code 0x2E.

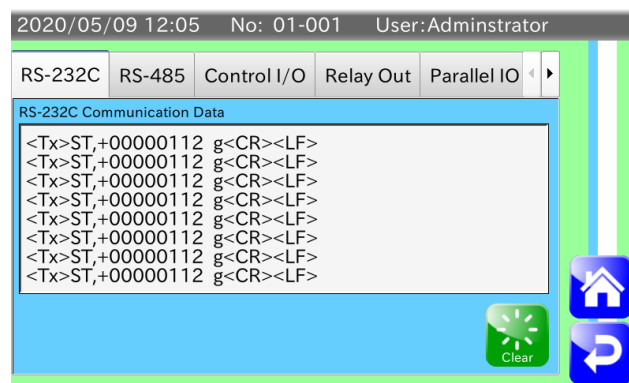

Drawing 88 RS-232C communication data

## 9.29.2. RS-485

Received data and transmission data are displayed in order of a time series.

Leading four characters of data is used to identify either received data or transmission data.

(In case of transmission data, <Tx> is displayed. In case of received data, <Rx> is displayed.)

Regarding of received data, carriage return is performed at the following process.

- If <CR> is received and next code is not <CR><LF>.
- If <LF> is received.
- If transmission data is transmitted during receiving data.
- If control code except <CR><LF> is received, <.> is displayed.

If Modbus RTU is specified, communication function of RS-485 becomes ineffective.

Touch the "Clear" key  to delete data on the text box.

<CR> : Carriage return. Hex code 0x0D.

<LF> : Line feed. Hex code 0x0A.

<.> : Period. Hex code 0x2E.

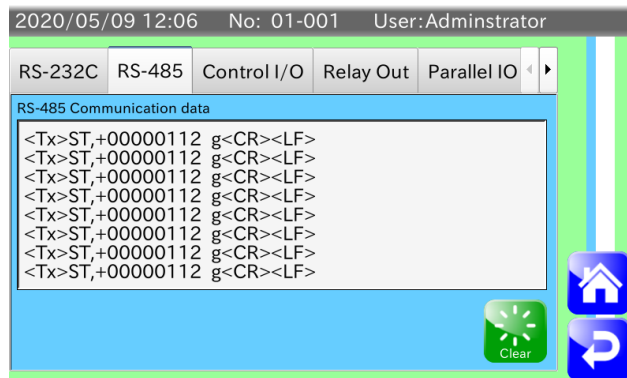

Drawing 89 RS-485C communication data

## 9.29.3. Control I/O

Whole terminal status of the control I/O are displayed.

When a signal of DI or DO becomes to ON state, ● is displayed.

When a signal of DI or DO becomes to OFF state, ○ is displayed.

DI : Digital input

DO : Digital output

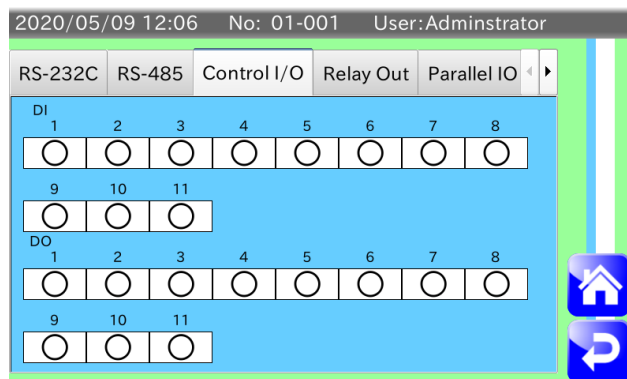

Drawing 90 Control Input/Output



### 9.29.4. OP-02 Relay Output

Whole terminal status of the OP-02 relay output are displayed.

When a signal of DO becomes to ON state, ● is displayed.

DO : Digital output

When a signal of DO becomes to OFF state, ○ is displayed.

If OP-02 relay output is not connected, message of connection state is displayed.

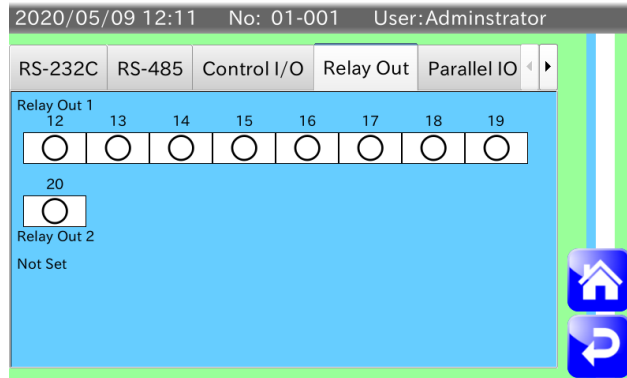

Drawing 91 Relay Output

### 9.29.5. OP-05 Parallel I/O

Whole terminal status of the OP-05 parallel I/O are displayed.

When a signal of DI or DO becomes to ON state, ● is displayed.

DI : Digital input

When a signal of DI or DO becomes to OFF state, ○ is displayed.

DO : Digital output

If OP-05 parallel I/O is not connected, message of connection state is displayed.

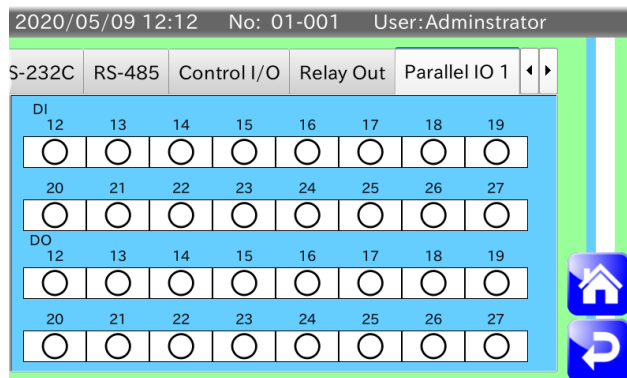

Drawing 92 Parallel Input/Output

## 9.29.6. OP-07 Analog Output

Voltage output value of OP-07 analog output is displayed.

Output voltage may contain error against the indication value.

If OP-07 analog output or OP-17 analog output is not connected, message of connection state is displayed.

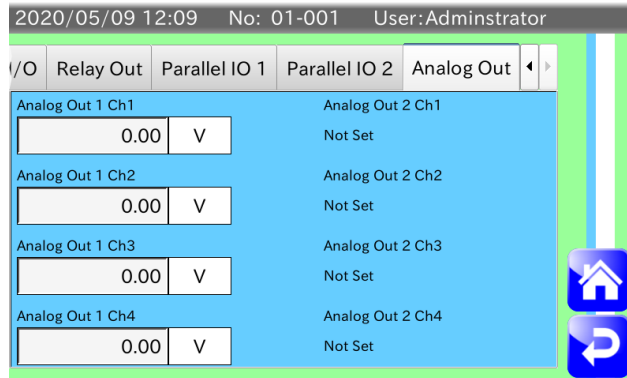

**Drawing 93 Analog Output**

# 10. Modbus Communication

Modbus is a communications protocol developed by Modicon.

If this device uses modbus, it can communicate with other devices equipped with modbus without special programs.

This indicator can use Modbus RTU (of serial communication using RS-485) and Modbus TCP (of serial communication expanded to TCP/IP).

Modbus communication can perform to change the settings, to read summary data, to write to DI, to read DO status and etc.

Refer to the "[10.1. Using Modbus RTU](#)" to "[10.6. Communication Command of Modbus TCP](#)".

## Cautions

1. The product settings selected for weighing can be changed only via Modbus communication.
2. When group numbers or product numbers are changed, applicable product will be read. If applicable product is nothing, new registration will be performed and new settings will be read.
3. If the number of the product and etc. are changed via Modbus communication, the changes needs for several seconds.
4. In Modbus communication, the simultaneity and real time are not guaranteed. For example, when the whole data of address map are read, the whole data cannot be read at the same time. It may depend used systems and commands. Additionally, the weighing result may not include all weighing data.
5. When address is specified in Modbus communication, specify an address value subtract 1 from value of the "[10.5. Address](#)", except reference number.

## Note

- When data is written to the holding register via Modbus communication, the information bar blinks on the upper side of the window.
- Refer to the "[8.2. Connecting the LAN interface](#)" and "[11.3. RS-485](#)" for using Modbus RTU and Modbus TCP.
- When Modbus TCP is used on the indicator, the settings of LAN interface needs. Refer to the "[6.3. Setting up LAN interface](#)" for the settings procedure.

## 10.1. Using Modbus RTU

Step 1. Touch the "Connection" tab in the Common setting window.  
Select "Modbus RTU" in the "Modbus".

### Cautions

- Restart the indicator when the settings of the "Modbus" is changed.  
New settings will be effective after restarting system.
- When the "Modbus RTU" is specified to the settings of the "Modbus", the "RS-485" settings of port number and output format are ignored, the "RS-485" settings of baud rate, parity and stop bit are effective. (Length of data bit is a fixed 8 bits. )

Step 2. Input a slave address.

Step 3. Enter the settings of RS-485 at the "Connect" tab in the "Common settings window".

### Cautions

- Refer to the "9.24. Modbus" for serial communication settings

Step 4. The indicator can communicate with serial interface connected.

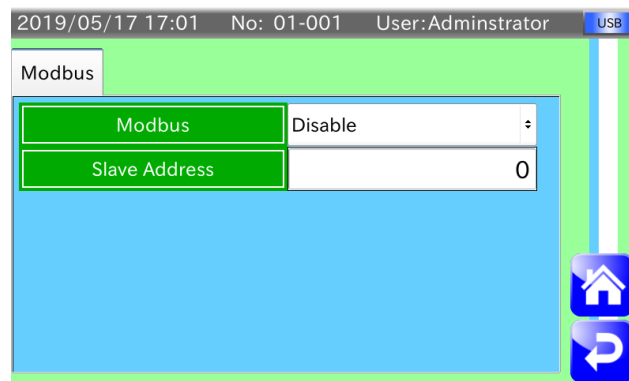

Drawing 94 Communication mode

## 10.2. Using Modbus TCP

Step 1. Touch the "Connection" tab in the Common setting window.  
Select "Modbus TCP" in the "Modbus".

### Cautions

- Restart the indicator when the settings of the "Modbus" is changed.  
New settings will be effective after restarting system.

Step 2. Select and input a slave address.

Step 3. The indicator can communicate with LAN cable connected.

## 10.3. Communication Command of Modbus

This section describes the commands of Modbus communication.

For example, the reading of the input register and the writing to the holding register are described.

### Cautions

- Examples uses Modbus RTU.  
Refer to documentations of the Modbus TCP protocol for commands.

### 10.3.1. Example of Reading Input Register

Example is to read total number (address 20045) of all summary in the input register.

#### Transmission Command

The transmission command consists of start address of the input register and number of the input register to read data.

When total number of all summary is read from the input register, specify an address 44 subtract 1 from value of the "10.5. Address" , except reference number.

Specify 2 to number of the input register because total number of all summary is 4 byte.

Example of transmission command is shown as table below.

Table 8 Example of transmission command (Reading input register)

Command description		Transmission data
Slave address		0x01
Function code		0x04
Start address	(high-order)	0x00
Start address	(low-order)	0x2C
Number of register	(high-order)	0x00
Number of register	(low-order)	0x02
Error check		CRC (16 bits)

#### Response

Example of the response when command is processed properly is shown as table below.

Table 9 Example of response (Reading input register)

Command description		Response data
Slave address		0x01
Function code		0x04
Number of data in bytes		0x04
Data 1	(high-order)	0x03
Data 1	(low-order)	0xE8
Data 2	(high-order)	0x00
Data 2	(low-order)	0x00
Error check		CRC (16 bits)

### 10.3.2. Example of Writing Holding Register

---

Example is to write product number (address 40001) in the holding register.

#### Transmission Command

The transmission command consists of start address of the holding register and data overwritten.

When product number is written to the holding register, specify an address 0 subtract 1 from value of the "10.5. Address", except reference number. Specify product number as 2.

Example of transmission command is shown as table below.

Table 10 Example of transmission command (Writing to holding register)

Command description		Transmission data
Slave address		0x01
Function code		0x06
Start address	(high-order)	0x00
Start address	(low-order)	0x00
Number of register	(high-order)	0x00
Number of register	(low-order)	0x02
Error check		CRC (16 bits)

#### Response

When command is processed properly, the response is the same as transmission command. The response is shown as table below.

Table 11 Example of response (Writing to holding register)

Command description		Response data
Slave address		0x01
Function code		0x06
Start address	(high-order)	0x00
Start address	(low-order)	0x00
Number of register	(high-order)	0x00
Number of register	(low-order)	0x02
Error check		CRC (16 bits)

### 10.3.3. Example of Exception Response

When the indicator receives command that cannot be processed in Modbus communication, an exception is responded. Address of "out of range (Address 30130)" of the input register is read.

#### Transmission Command

Example of transmission command to address 30130 is shown as table below.

Table 12 Example of transmission command (Reading input register / Out of range)

Command description		Transmission data
Slave address		0x01
Function code		0x04
Start address	(high-order)	0x00
Start address	(low-order)	0x82
Number of register	(high-order)	0x00
Number of register	(low-order)	0x01
Error check		CRC (16 bits)

#### Response

Because the address 30130 of the input register doesn't exist, the exception response like an example table below is shown. The function code of exception response is value added 0x80 to code of transmission command.

Table 13 Example of response (Reading input register / Out of range)

Command description		Response data
Slave address		0x01
Function code		0x84
Exception code		0x02
Error check		CRC (16 bits)

Exception code and its contents are shown below.

Table 14 Exception code

Exception code	Name	Description
01	Wrong function	The corresponding function is not compatible.
02	Wrong data address	The specified address does not exist.
03	Wrong data	The specified data is not allowed.

## 10.4. Reference Number

The command to the indicator and reading of data use "reference number" and "address" in Modbus communication.

The type of data and reference number are show Table 15.

Table 15 Reference number

Data type	Reference number	Data description
Output coil	0	It is dedicated bit to write data. It is used for control of DI1 to DI4.
Input status	1	It is dedicated bit to read data. It is used for monitor of DI and DO.
Input register	3	It is dedicated word data to read. It is used to read weighing value and summary.
Holding register	4	It is word data to able to read and write. It is used to change the settings and to read product settings.

## 10.5. Address

Address of Modbus is listed from Table 17 to Table 19.

Table 16 Output coil address

Address	Name
1	DI1
2	DI2
3	DI3
4	DI4
5	DI5
6	DI6
7	DI7
8	DI8
9	DI9
10	DI10
11	DI11
12	DI12
13	DI13
14	DI14
15	DI15
16	DI16
17	DI17
18	DI18
19	DI19
20	DI20
21	DI21
22	DI22

Address	Name
23	DI23
24	DI24
25	DI25
26	DI26
27	DI27
28	DI28
29	DI29
30	DI30
31	DI31
32	DI32
33	DI33
34	DI34
35	DI35
36	DI36
37	DI37
38	DI38
39	DI39
40	DI40
41	DI41
42	DI42
43	DI43



Address	Name	
1	DI 1	(The status of DI 1 is indicated.)
2	DI 2	(The status of DI 2 is indicated.)
3	DI 3	(The status of DI 3 is indicated.)
4	DI 4	(The status of DI 4 is indicated.)
5	DI 5	(The status of DI 5 is indicated.)
6	DI 6	(The status of DI 6 is indicated.)
7	DI 7	(The status of DI 7 is indicated.)
8	DI 8	(The status of DI 8 is indicated.)
9	DI 9	(The status of DI 9 is indicated.)
10	DI 10	(The status of DI 10 is indicated.)
11	DI 11	(The status of DI 11 is indicated.)
12	DI 12	(The status of DI 12 is indicated.)
13	DI 13	(The status of DI 13 is indicated.)
14	DI 14	(The status of DI 14 is indicated.)
15	DI 15	(The status of DI 15 is indicated.)
16	DI 16	(The status of DI 16 is indicated.)
17	DI 17	(The status of DI 17 is indicated.)
18	DI 18	(The status of DI 18 is indicated.)
19	DI 19	(The status of DI 19 is indicated.)
20	DI 20	(The status of DI 20 is indicated.)
21	DI 21	(The status of DI 21 is indicated.)
22	DI 22	(The status of DI 22 is indicated.)
23	DI 23	(The status of DI 23 is indicated.)
24	DI 24	(The status of DI 24 is indicated.)
25	DI 25	(The status of DI 25 is indicated.)
26	DI 26	(The status of DI 26 is indicated.)
27	DI 27	(The status of DI 27 is indicated.)
28	DI 28	(The status of DI 28 is indicated.)
29	DI 29	(The status of DI 29 is indicated.)
30	DI 30	(The status of DI 30 is indicated.)
31	DI 31	(The status of DI 31 is indicated.)
32	DI 32	(The status of DI 32 is indicated.)
33	DI 33	(The status of DI 33 is indicated.)
34	DI 34	(The status of DI 34 is indicated.)
35	DI 35	(The status of DI 35 is indicated.)
36	DI 36	(The status of DI 36 is indicated.)
37	DI 37	(The status of DI 37 is indicated.)
38	DI 38	(The status of DI 38 is indicated.)
39	DI 39	(The status of DI 39 is indicated.)
40	DI 40	(The status of DI 40 is indicated.)
41	DI 41	(The status of DI 41 is indicated.)
42	DI 42	(The status of DI 42 is indicated.)
43	DI 43	(The status of DI 43 is indicated.)

## Input status 2/5

Address	名称
44	
45	
46	
47	
48	
49	
50	
51	
52	
53	
54	Do not use address because of reserved expansion number.
55	
56	
57	
58	
59	
60	
61	
62	
63	
64	
65	DI Status 1 (The status of function assigned to DI 1 is indicated.) ※
66	DI Status 2 (The status of function assigned to DI 2 is indicated.) ※
67	DI Status 3 (The status of function assigned to DI 3 is indicated.) ※
68	DI Status 4 (The status of function assigned to DI 4 is indicated.) ※
69	DI Status 5 (The status of function assigned to DI 5 is indicated.) ※
70	DI Status 6 (The status of function assigned to DI 6 is indicated.) ※
71	DI Status 7 (The status of function assigned to DI 7 is indicated.) ※
72	DI Status 8 (The status of function assigned to DI 8 is indicated.) ※
73	DI Status 9 (The status of function assigned to DI 9 is indicated.) ※
74	DI Status 10 (The status of function assigned to DI 10 is indicated.) ※
75	DI Status 11 (The status of function assigned to DI 11 is indicated.) ※
76	DI Status 12 (The status of function assigned to DI 12 is indicated.) ※
77	DI Status 13 (The status of function assigned to DI 13 is indicated.) ※
78	DI Status 14 (The status of function assigned to DI 14 is indicated.) ※
79	DI Status 15 (The status of function assigned to DI 15 is indicated.) ※
80	DI Status 16 (The status of function assigned to DI 16 is indicated.) ※
81	DI Status 17 (The status of function assigned to DI 17 is indicated.) ※
82	DI Status 18 (The status of function assigned to DI 18 is indicated.) ※
83	DI Status 19 (The status of function assigned to DI 19 is indicated.) ※

※ Status of DI 1 to DI 43

Operation status of DI 1 to DI 43 are indicated. Each DI is assigned to hardware and the output coil of Modbus simultaneously. DI status indicates both operation status.

### Input status 3/5

Address	Name		
84	DI Status 20	(The status of function assigned to DI 20 is indicated.)	※
85	DI Status 21	(The status of function assigned to DI 21 is indicated.)	※
86	DI Status 22	(The status of function assigned to DI 22 is indicated.)	※
87	DI Status 23	(The status of function assigned to DI 23 is indicated.)	※
88	DI Status 24	(The status of function assigned to DI 24 is indicated.)	※
89	DI Status 25	(The status of function assigned to DI 25 is indicated.)	※
90	DI Status 26	(The status of function assigned to DI 26 is indicated.)	※
91	DI Status 27	(The status of function assigned to DI 27 is indicated.)	※
92	DI Status 28	(The status of function assigned to DI 28 is indicated.)	※
93	DI Status 29	(The status of function assigned to DI 29 is indicated.)	※
94	DI Status 30	(The status of function assigned to DI 30 is indicated.)	※
95	DI Status 31	(The status of function assigned to DI 31 is indicated.)	※
96	DI Status 32	(The status of function assigned to DI 32 is indicated.)	※
97	DI Status 33	(The status of function assigned to DI 33 is indicated.)	※
98	DI Status 34	(The status of function assigned to DI 34 is indicated.)	※
99	DI Status 35	(The status of function assigned to DI 35 is indicated.)	※
100	DI Status 36	(The status of function assigned to DI 36 is indicated.)	※
101	DI Status 37	(The status of function assigned to DI 37 is indicated.)	※
102	DI Status 38	(The status of function assigned to DI 38 is indicated.)	※
103	DI Status 39	(The status of function assigned to DI 39 is indicated.)	※
104	DI Status 40	(The status of function assigned to DI 40 is indicated.)	※
105	DI Status 41	(The status of function assigned to DI 41 is indicated.)	※
106	DI Status 42	(The status of function assigned to DI 42 is indicated.)	※
107	DI Status 43	(The status of function assigned to DI 43 is indicated.)	※

※ Status of DI 1 to DI 43

Operation status of DI 1 to DI 43 are indicated. Each DI is assigned to hardware and the output coil of Modbus simultaneously. DI status indicates both operation status.

**Input status 4/5**

Address	Name
108	
109	
110	
111	
112	
113	
114	
115	
116	
117	
118	Do not use address because of reserved expansion number.
119	
120	
121	
122	
123	
124	
125	
126	
127	
128	
129	DO STOP
130	DO BZ
131	DO 1
132	DO 2
133	DO 3
134	DO 4
135	DO 5
136	DO 6
137	DO 7
138	DO 8
139	DO 9
140	DO 10
141	DO 11
142	DO 12
143	DO 13
144	DO 14
145	DO 15
146	DO 16
147	DO 17
148	DO 18
149	DO 19
150	DO 20
151	DO 21

**Input status 5/5**

152	DO 22
153	DO 23
154	DO 24
155	DO 25
156	DO 26
157	DO 27
158	DO 28
159	DO 29
160	DO 30
161	DO 31
162	DO 32
163	DO 33
164	DO 34
165	DO 35
166	DO 36
167	DO 37
168	DO 38
169	DO 39
170	DO 40
171	DO 41
172	DO 42
173	DO 43
174	Do not use address because of reserved expansion number.
175	
176	
177	
178	
179	
180	
181	
182	
183	
184	
185	
186	
187	
188	
189	
190	
191	
192	

Address	Name	Size	Output range
1	IP address 1 of wired LAN for this indicator (high-order)	2 bytes	0 - 255
2	IP address 2 of wired LAN for this indicator	2 bytes	0 - 255
3	IP address 3 of wired LAN for this indicator	2 bytes	0 - 255
4	IP address 4 of wired LAN for this indicator (low-order)	2 bytes	0 - 255
5	Subnet mask 1 of this indicator (high-order)	2 bytes	0 - 255
6	Subnet mask 2 of this indicator	2 bytes	0 - 255
7	Subnet mask 3 of this indicator	2 bytes	0 - 255
8	Subnet mask 4 of this indicator (low-order)	2 bytes	0 - 255
9	Default gateway 1 of this indicator (high-order)	2 bytes	0 - 255
10	Default gateway 2 of this indicator	2 bytes	0 - 255
11	Default gateway 3 of this indicator	2 bytes	0 - 255
12	Default gateway 4 of this indicator (low-order)	2 bytes	0 - 255
13	Wireless LAN port	2 bytes	0 - 1
14	IP address 1 of wireless LAN for this indicator (high-order)	2 bytes	0 - 255
15	IP address 2 of wireless LAN for this indicator	2 bytes	0 - 255
16	IP address 3 of wireless LAN for this indicator	2 bytes	0 - 255
17	IP address 4 of wireless LAN for this indicator (low-order)	2 bytes	0 - 255
18	Do not use address because of reserved expansion number.		
19	IP address 1 for printer (high-order)	2 bytes	0 - 255
20	IP address 2 for printer	2 bytes	0 - 255
21	IP address 3 for printer	2 bytes	0 - 255
22	IP address 4 for printer (low-order)	2 bytes	0 - 255
23	RS-232C Port number	2 bytes	0 - 4
24	RS-232C Output mode	2 bytes	0 - 2
25	RS-232C Baud rate	2 bytes	0 - 5
26	RS-232C Parity	2 bytes	0 - 2
27	RS-232C Data length	2 bytes	0 - 1
28	RS-232C Stop bit	2 bytes	0 - 1
29	RS-485 Port number	2 bytes	0 - 2
30	RS-485 Output mode	2 bytes	0 - 2
31	RS-485 Baud rate	2 bytes	0 - 5
32	RS-485 Parity	2 bytes	0 - 2
33	RS-485 Data length	2 bytes	0 - 1
34	RS-485 Stop bit	2 bytes	0 - 1
35	Modbus Settings	2 bytes	0 - 1
36	Modbus Slave address	2 bytes	1 - 247
37	Random check	2 bytes	0 - 1
38	Unit	2 bytes	0 - 3
39	User management level	2 bytes	0 - 3
40	Conveyor mode	2 bytes	0 - 1
41	Type of Data 1 - 1ch	2 bytes	0 - 1
42	Type of Data 1 - 2ch	2 bytes	0 - 1
43	Type of Data 1 - 3ch	2 bytes	0 - 1
44	Type of Data 1 - 4ch	2 bytes	0 - 1

## Input register 2/5

Address	Name		Size	Output range
45	Type of Data	2 - 1ch	2 bytes	0 - 1
46	Type of Data	2 - 2ch	2 bytes	0 - 1
47	Type of Data	2 - 3ch	2 bytes	0 - 1
48	Type of Data	2 - 4ch	2 bytes	0 - 1
49	Output format	1 - 1ch	2 bytes	0 - 1
50	Output format	1 - 2ch	2 bytes	0 - 1
51	Output format	1 - 3ch	2 bytes	0 - 1
52	Output format	1 - 4ch	2 bytes	0 - 1
53	Output format	2 - 1ch	2 bytes	0 - 1
54	Output format	2 - 2ch	2 bytes	0 - 1
55	Output format	2 - 3ch	2 bytes	0 - 1
56	Output format	2 - 4ch	2 bytes	0 - 1
57	Low current standard	1 - 1ch	2 bytes	0 - 2
58	Low current standard	1 - 2ch	2 bytes	0 - 2
59	Low current standard	1 - 3ch	2 bytes	0 - 2
60	Low current standard	1 - 4ch	2 bytes	0 - 2
61	Low current standard	2 - 1ch	2 bytes	0 - 2
62	Low current standard	2 - 2ch	2 bytes	0 - 2
63	Low current standard	2 - 3ch	2 bytes	0 - 2
64	Low current standard	2 - 4ch	2 bytes	0 - 2
65	High current standard	1 - 1ch	2 bytes	0 - 2
66	High current standard	1 - 2ch	2 bytes	0 - 2
67	High current standard	1 - 3ch	2 bytes	0 - 2
68	High current standard	1 - 4ch	2 bytes	0 - 2
69	High current standard	2 - 1ch	2 bytes	0 - 2
70	High current standard	2 - 2ch	2 bytes	0 - 2
71	High current standard	2 - 3ch	2 bytes	0 - 2
72	High current standard	2 - 4ch	2 bytes	0 - 2
73	Low current output of weight	1 - 1ch	4 bytes	
75	Low current output of weight	1 - 2ch	4 bytes	
77	Low current output of weight	1 - 3ch	4 bytes	
79	Low current output of weight	1 - 4ch	4 bytes	
81	Low current output of weight	2 - 1ch	4 bytes	
83	Low current output of weight	2 - 2ch	4 bytes	
85	Low current output of weight	2 - 3ch	4 bytes	
87	Low current output of weight	2 - 4ch	4 bytes	
89	High current output of weight	1 - 1ch	4 bytes	
91	High current output of weight	1 - 2ch	4 bytes	
93	High current output of weight	1 - 3ch	4 bytes	
95	High current output of weight	1 - 4ch	4 bytes	
97	High current output of weight	2 - 1ch	4 bytes	
99	High current output of weight	2 - 2ch	4 bytes	
101	High current output of weight	2 - 3ch	4 bytes	
103	High current output of weight	2 - 4ch	4 bytes	

### Input register 3/5

Address	Name	Size	Output range
105	Low current output of conveyor velocity 1 - 1ch	2 bytes	
106	Low current output of conveyor velocity 1 - 2ch	2 bytes	
107	Low current output of conveyor velocity 1 - 3ch	2 bytes	
108	Low current output of conveyor velocity 1 - 4ch	2 bytes	
109	Low current output of conveyor velocity 2 - 1ch	2 bytes	
110	Low current output of conveyor velocity 2 - 2ch	2 bytes	
111	Low current output of conveyor velocity 2 - 3ch	2 bytes	
112	Low current output of conveyor velocity 2 - 4ch	2 bytes	
113	High current output of conveyor velocity 1 - 1ch	2 bytes	
114	High current output of conveyor velocity 1 - 2ch	2 bytes	
115	High current output of conveyor velocity 1 - 3ch	2 bytes	
116	High current output of conveyor velocity 1 - 4ch	2 bytes	
117	High current output of conveyor velocity 2 - 1ch	2 bytes	
118	High current output of conveyor velocity 2 - 2ch	2 bytes	
119	High current output of conveyor velocity 2 - 3ch	2 bytes	
120	High current output of conveyor velocity 2 - 4ch	2 bytes	
121	Low voltage standard 1 - 1ch	2 bytes	0 - 2
122	Low voltage standard 1 - 2ch	2 bytes	0 - 2
123	Low voltage standard 1 - 3ch	2 bytes	0 - 2
124	Low voltage standard 1 - 4ch	2 bytes	0 - 2
125	Low voltage standard 2 - 1ch	2 bytes	0 - 2
126	Low voltage standard 2 - 2ch	2 bytes	0 - 2
127	Low voltage standard 2 - 3ch	2 bytes	0 - 2
128	Low voltage standard 2 - 4ch	2 bytes	0 - 2
129	High voltage standard 1 - 1ch	2 bytes	0 - 7
130	High voltage standard 1 - 2ch	2 bytes	0 - 7
131	High voltage standard 1 - 3ch	2 bytes	0 - 7
132	High voltage standard 1 - 4ch	2 bytes	0 - 7
133	High voltage standard 2 - 1ch	2 bytes	0 - 7
134	High voltage standard 2 - 2ch	2 bytes	0 - 7
135	High voltage standard 2 - 3ch	2 bytes	0 - 7
136	High voltage standard 2 - 4ch	2 bytes	0 - 7
137	Low voltage output of weight 1 - 1ch	4 bytes	
139	Low voltage output of weight 1 - 2ch	4 bytes	
141	Low voltage output of weight 1 - 3ch	4 bytes	
143	Low voltage output of weight 1 - 4ch	4 bytes	
145	Low voltage output of weight 2 - 1ch	4 bytes	
147	Low voltage output of weight 2 - 2ch	4 bytes	
149	Low voltage output of weight 2 - 3ch	4 bytes	
151	Low voltage output of weight 2 - 4ch	4 bytes	
153	High voltage output of weight 1 - 1ch	4 bytes	
155	High voltage output of weight 1 - 2ch	4 bytes	
157	High voltage output of weight 1 - 3ch	4 bytes	
159	High voltage output of weight 1 - 4ch	4 bytes	



## Input register 4/5

Address	Name	Size	Output range
161	High voltage output of weight 2 - 1ch	4 bytes	
163	High voltage output of weight 2 - 2ch	4 bytes	
165	High voltage output of weight 2 - 3ch	4 bytes	
167	High voltage output of weight 2 - 4ch	4 bytes	
169	Low voltage output of conveyor velocity 1 - 1ch	2 bytes	
170	Low voltage output of conveyor velocity 1 - 2ch	2 bytes	
171	Low voltage output of conveyor velocity 1 - 3ch	2 bytes	
172	Low voltage output of conveyor velocity 1 - 4ch	2 bytes	
173	Low voltage output of conveyor velocity 2 - 1ch	2 bytes	
174	Low voltage output of conveyor velocity 2 - 2ch	2 bytes	
175	Low voltage output of conveyor velocity 2 - 3ch	2 bytes	
176	Low voltage output of conveyor velocity 2 - 4ch	2 bytes	
177	High voltage output of conveyor velocity 1 - 1ch	2 bytes	
178	High voltage output of conveyor velocity 1 - 2ch	2 bytes	
179	High voltage output of conveyor velocity 1 - 3ch	2 bytes	
180	High voltage output of conveyor velocity 1 - 4ch	2 bytes	
181	High voltage output of conveyor velocity 2 - 1ch	2 bytes	
182	High voltage output of conveyor velocity 2 - 2ch	2 bytes	
183	High voltage output of conveyor velocity 2 - 3ch	2 bytes	
184	High voltage output of conveyor velocity 2 - 4ch	2 bytes	
185	Zero point	4 bytes	0.000000 – 9.999999
187	Span	4 bytes	0.000000 – 9.999999
189	Length of the conveyor	2 bytes	1 – 9999
190	All summary Total number	4 bytes	0 – 9999999
192	All summary Number of OK items	4 bytes	0 – 9999999
194	All summary Number of HiHi	4 bytes	0 – 9999999
196	All summary Number of Hi	4 bytes	0 – 9999999
198	All summary Number of Lo	4 bytes	0 – 9999999
200	All summary Number of LoLo	4 bytes	0 – 9999999
202	All summary Number of detect two	4 bytes	0 – 9999999
204	All summary Number of unsplit	4 bytes	0 – 9999999
206	All summary Number of foreign matter	4 bytes	0 – 9999999
208	All summary Total weight (Gross value)	4 bytes	0 – 9999.9999
210	All summary Averaged weight value	4 bytes	0 – 9999.9999
212	All summary Maximum value	4 bytes	0 – 9999.9999
214	All summary Minimum value	4 bytes	0 – 9999.9999
216	All summary Range	4 bytes	0 – 9999.9999
218	All summary SD (Standard deviation)	4 bytes	0 – 1.00000
220	All summary CV (Coefficient of variation)	2 bytes	0 – 99.99
221	OK summary Total number	4 bytes	0 – 9999999
223	OK summary Total weight (Gross value)	4 bytes	0 – 9999.9999
225	OK summary Averaged weighing value	4 bytes	0 – 9999.9999
227	OK summary Maximum value	4 bytes	0 – 9999.9999
229	OK summary Minimum value	4 bytes	0 – 9999.9999

## Input register 5/5

Address	Name	Size	Output range
231	OK summary Range	4 bytes	0 – 9999.9999
233	OK summary SD (Standard deviation)	4 bytes	0 – 1.00000
235	OK summary CV (Coefficient of variation)	2 bytes	0 – 99.99
236	Sample summary Total number	4 bytes	0 – 9999999
238	Sample summary Number of OK items	4 bytes	0 – 9999999
240	Sample summary Number of HiHi	4 bytes	0 – 9999999
242	Sample summary Number of Hi	4 bytes	0 – 9999999
244	Sample summary Number of LoLo	4 bytes	0 – 9999999
246	Sample summary Number of Lo	4 bytes	0 – 9999999
248	Sample summary Number of detect two	4 bytes	0 – 9999999
250	Sample summary Number of unsplit	4 bytes	0 – 9999999
252	Sample summary Number of foreign matter	4 bytes	0 – 9999999
254	Sample summary Total weight (Gross value)	4 bytes	0 – 9999.999
256	Sample summary Averaged weighing value	4 bytes	0 – 9999.999
258	Sample summary Maximum value	4 bytes	0 – 9999.999
260	Sample summary Minimum value	4 bytes	0 – 9999.999
262	Sample summary Range	4 bytes	0 – 9999.999
264	Sample summary SD (Standard deviation)	4 bytes	0 – 1.00000
266	Sample summary CV (Coefficient of variation)	2 bytes	0 – 99.99
267	OK sample summary Total number	4 bytes	0 – 9999999
269	OK sample summary Total weight (Gross value)	4 bytes	0 – 9999.9999
271	OK sample summary Averaged weighing value	4 bytes	0 – 9999.9999
273	OK sample summary Maximum value	4 bytes	0 – 9999.9999
275	OK sample summary Minimum value	4 bytes	0 – 9999.9999
277	OK sample summary Range	4 bytes	0 – 9999.9999
279	OK sample summary SD (Standard deviation)	4 bytes	0 – 1.00000
281	OK sample summary CV (Coefficient of variation)	2 bytes	0 – 99.99
282	Weighing result	4 bytes	0 – 9999.9999

Address	Name	Size	Output range
1	Product number	2 bytes	1 – 100
2	Group number	2 bytes	1 – 10
3	Language	2 bytes	0 – 3
4	Transition time to standby mode	2 bytes	0.0 – 999.9
5	Settings of DI 1 (Map)	4 bytes	0 – 1024
7	Settings of DI 2 (Map)	4 bytes	0 – 1024
9	Settings of DI 3 (Map)	4 bytes	0 – 1024
11	Settings of DI 4 (Map)	4 bytes	0 – 1024
13	Settings of DI 5 (Map)	4 bytes	0 – 1024
15	Settings of DI 6 (Map)	4 bytes	0 – 1024
17	Settings of DI 7 (Map)	4 bytes	0 – 1024
19	Settings of DI 8 (Map)	4 bytes	0 – 1024
21	Settings of DI 9 (Map)	4 bytes	0 – 1024
23	Settings of DI 10 (Map)	4 bytes	0 – 1024
25	Settings of DI 11 (Map)	4 bytes	0 – 1024
27	Settings of DI 12 (Map)	4 bytes	0 – 1024
29	Settings of DI 13 (Map)	4 bytes	0 – 1024
31	Settings of DI 14 (Map)	4 bytes	0 – 1024
33	Settings of DI 15 (Map)	4 bytes	0 – 1024
35	Settings of DI 16 (Map)	4 bytes	0 – 1024
37	Settings of DI 17 (Map)	4 bytes	0 – 1024
39	Settings of DI 18 (Map)	4 bytes	0 – 1024
41	Settings of DI 19 (Map)	4 bytes	0 – 1024
43	Settings of DI 20 (Map)	4 bytes	0 – 1024
45	Settings of DI 21 (Map)	4 bytes	0 – 1024
47	Settings of DI 22 (Map)	4 bytes	0 – 1024
49	Settings of DI 23 (Map)	4 bytes	0 – 1024
51	Settings of DI 24 (Map)	4 bytes	0 – 1024
53	Settings of DI 25 (Map)	4 bytes	0 – 1024
55	Settings of DI 26 (Map)	4 bytes	0 – 1024
57	Settings of DI 27 (Map)	4 bytes	0 – 1024
59	Settings of DI 28 (Map)	4 bytes	0 – 1024
61	Settings of DI 29 (Map)	4 bytes	0 – 1024
63	Settings of DI 30 (Map)	4 bytes	0 – 1024
65	Settings of DI 31 (Map)	4 bytes	0 – 1024
67	Settings of DI 32 (Map)	4 bytes	0 – 1024
69	Settings of DI 33 (Map)	4 bytes	0 – 1024
71	Settings of DI 34 (Map)	4 bytes	0 – 1024
73	Settings of DI 35 (Map)	4 bytes	0 – 1024
75	Settings of DI 36 (Map)	4 bytes	0 – 1024
77	Settings of DI 37 (Map)	4 bytes	0 – 1024
79	Settings of DI 38 (Map)	4 bytes	0 – 1024
81	Settings of DI 39 (Map)	4 bytes	0 – 1024

## Holding register 2/13

Address	Name	Size	Output range
83	Settings of DI 40 (Map)	4 bytes	0 – 1024
85	Settings of DI 41 (Map)	4 bytes	0 – 1024
87	Settings of DI 42 (Map)	4 bytes	0 – 1024
89	Settings of DI 43 (Map)	4 bytes	0 – 1024
91	Input trigger of DI 1	2 bytes	0 – 4
92	Input trigger of DI 2	2 bytes	0 – 4
93	Input trigger of DI 3	2 bytes	0 – 4
94	Input trigger of DI 4	2 bytes	0 – 4
95	Input trigger of DI 5	2 bytes	0 – 4
96	Input trigger of DI 6	2 bytes	0 – 4
97	Input trigger of DI 7	2 bytes	0 – 4
98	Input trigger of DI 8	2 bytes	0 – 4
99	Input trigger of DI 9	2 bytes	0 – 4
100	Input trigger of DI 10	2 bytes	0 – 4
101	Input trigger of DI 11	2 bytes	0 – 4
102	Input trigger of DI 12	2 bytes	0 – 4
103	Input trigger of DI 13	2 bytes	0 – 4
104	Input trigger of DI 14	2 bytes	0 – 4
105	Input trigger of DI 15	2 bytes	0 – 4
106	Input trigger of DI 16	2 bytes	0 – 4
107	Input trigger of DI 17	2 bytes	0 – 4
108	Input trigger of DI 18	2 bytes	0 – 4
109	Input trigger of DI 19	2 bytes	0 – 4
110	Input trigger of DI 20	2 bytes	0 – 4
111	Input trigger of DI 21	2 bytes	0 – 4
112	Input trigger of DI 22	2 bytes	0 – 4
113	Input trigger of DI 23	2 bytes	0 – 4
114	Input trigger of DI 24	2 bytes	0 – 4
115	Input trigger of DI 25	2 bytes	0 – 4
116	Input trigger of DI 26	2 bytes	0 – 4
117	Input trigger of DI 27	2 bytes	0 – 4
118	Input trigger of DI 28	2 bytes	0 – 4
119	Input trigger of DI 29	2 bytes	0 – 4
120	Input trigger of DI 30	2 bytes	0 – 4
121	Input trigger of DI 31	2 bytes	0 – 4
122	Input trigger of DI 32	2 bytes	0 – 4
123	Input trigger of DI 33	2 bytes	0 – 4
124	Input trigger of DI 34	2 bytes	0 – 4
125	Input trigger of DI 35	2 bytes	0 – 4
126	Input trigger of DI 36	2 bytes	0 – 4
127	Input trigger of DI 37	2 bytes	0 – 4
128	Input trigger of DI 38	2 bytes	0 – 4
129	Input trigger of DI 39	2 bytes	0 – 4
130	Input trigger of DI 40	2 bytes	0 – 4

### Holding register 3/13

Address	Name	Size	Output range
131	Input trigger of DI 41	2 bytes	0 – 4
132	Input trigger of DI 42	2 bytes	0 – 4
133	Input trigger of DI 43	2 bytes	0 – 4
134	Configuration of DI 1	2 bytes	0 – 25
135	Configuration of DI 2	2 bytes	0 – 25
136	Configuration of DI 3	2 bytes	0 – 25
137	Configuration of DI 4	2 bytes	0 – 25
138	Configuration of DI 5	2 bytes	0 – 25
139	Configuration of DI 6	2 bytes	0 – 25
140	Configuration of DI 7	2 bytes	0 – 25
141	Configuration of DI 8	2 bytes	0 – 25
142	Configuration of DI 9	2 bytes	0 – 25
143	Configuration of DI 10	2 bytes	0 – 25
144	Configuration of DI 11	2 bytes	0 – 25
145	Configuration of DI 12	2 bytes	0 – 25
146	Configuration of DI 13	2 bytes	0 – 25
147	Configuration of DI 14	2 bytes	0 – 25
148	Configuration of DI 15	2 bytes	0 – 25
149	Configuration of DI 16	2 bytes	0 – 25
150	Configuration of DI 17	2 bytes	0 – 25
151	Configuration of DI 18	2 bytes	0 – 25
152	Configuration of DI 19	2 bytes	0 – 25
153	Configuration of DI 20	2 bytes	0 – 25
154	Configuration of DI 21	2 bytes	0 – 25
155	Configuration of DI 22	2 bytes	0 – 25
156	Configuration of DI 23	2 bytes	0 – 25
157	Configuration of DI 24	2 bytes	0 – 25
158	Configuration of DI 25	2 bytes	0 – 25
159	Configuration of DI 26	2 bytes	0 – 25
160	Configuration of DI 27	2 bytes	0 – 25
161	Configuration of DI 28	2 bytes	0 – 25
162	Configuration of DI 29	2 bytes	0 – 25
163	Configuration of DI 30	2 bytes	0 – 25
164	Configuration of DI 31	2 bytes	0 – 25
165	Configuration of DI 32	2 bytes	0 – 25
166	Configuration of DI 33	2 bytes	0 – 25
167	Configuration of DI 34	2 bytes	0 – 25
168	Configuration of DI 35	2 bytes	0 – 25
169	Configuration of DI 36	2 bytes	0 – 25
170	Configuration of DI 37	2 bytes	0 – 25
171	Configuration of DI 38	2 bytes	0 – 25
172	Configuration of DI 39	2 bytes	0 – 25
173	Configuration of DI 40	2 bytes	0 – 25
174	Configuration of DI 41	2 bytes	0 – 25

## Holding register 4/13

Address	Name	Size	Output range
175	Configuration of DI 42	2 bytes	0 – 25
176	Configuration of DI 43	2 bytes	0 – 25
177	Chattering of DI 1	2 bytes	0.00 – 99.99
178	Chattering of DI 2	2 bytes	0.00 – 99.99
179	Chattering of DI 3	2 bytes	0.00 – 99.99
180	Chattering of DI 4	2 bytes	0.00 – 99.99
181	Chattering of DI 5	2 bytes	0.00 – 99.99
182	Chattering of DI 6	2 bytes	0.00 – 99.99
183	Chattering of DI 7	2 bytes	0.00 – 99.99
184	Chattering of DI 8	2 bytes	0.00 – 99.99
185	Chattering of DI 9	2 bytes	0.00 – 99.99
186	Chattering of DI 10	2 bytes	0.00 – 99.99
187	Chattering of DI 11	2 bytes	0.00 – 99.99
188	Chattering of DI 12	2 bytes	0.00 – 99.99
189	Chattering of DI 13	2 bytes	0.00 – 99.99
190	Chattering of DI 14	2 bytes	0.00 – 99.99
191	Chattering of DI 15	2 bytes	0.00 – 99.99
192	Chattering of DI 16	2 bytes	0.00 – 99.99
193	Chattering of DI 17	2 bytes	0.00 – 99.99
194	Chattering of DI 18	2 bytes	0.00 – 99.99
195	Chattering of DI 19	2 bytes	0.00 – 99.99
196	Chattering of DI 20	2 bytes	0.00 – 99.99
197	Chattering of DI 21	2 bytes	0.00 – 99.99
198	Chattering of DI 22	2 bytes	0.00 – 99.99
199	Chattering of DI 23	2 bytes	0.00 – 99.99
200	Chattering of DI 24	2 bytes	0.00 – 99.99
201	Chattering of DI 25	2 bytes	0.00 – 99.99
202	Chattering of DI 26	2 bytes	0.00 – 99.99
203	Chattering of DI 27	2 bytes	0.00 – 99.99
204	Chattering of DI 28	2 bytes	0.00 – 99.99
205	Chattering of DI 29	2 bytes	0.00 – 99.99
206	Chattering of DI 30	2 bytes	0.00 – 99.99
207	Chattering of DI 31	2 bytes	0.00 – 99.99
208	Chattering of DI 32	2 bytes	0.00 – 99.99
209	Chattering of DI 33	2 bytes	0.00 – 99.99
210	Chattering of DI 34	2 bytes	0.00 – 99.99
211	Chattering of DI 35	2 bytes	0.00 – 99.99
212	Chattering of DI 36	2 bytes	0.00 – 99.99
213	Chattering of DI 37	2 bytes	0.00 – 99.99
214	Chattering of DI 38	2 bytes	0.00 – 99.99
215	Chattering of DI 39	2 bytes	0.00 – 99.99
216	Chattering of DI 40	2 bytes	0.00 – 99.99
217	Chattering of DI 41	2 bytes	0.00 – 99.99
218	Chattering of DI 42	2 bytes	0.00 – 99.99

## Holding register 5/13

Address	Name	Size	Output range
219	Chattering of DI 43	2 bytes	0.00 - 99.99
220	Delay time of DI 1	2 bytes	0.00 - 99.99
221	Delay time of DI 2	2 bytes	0.00 - 99.99
222	Delay time of DI 3	2 bytes	0.00 - 99.99
223	Delay time of DI 4	2 bytes	0.00 - 99.99
224	Delay time of DI 5	2 bytes	0.00 - 99.99
225	Delay time of DI 6	2 bytes	0.00 - 99.99
226	Delay time of DI 7	2 bytes	0.00 - 99.99
227	Delay time of DI 8	2 bytes	0.00 - 99.99
228	Delay time of DI 9	2 bytes	0.00 - 99.99
229	Delay time of DI 10	2 bytes	0.00 - 99.99
230	Delay time of DI 11	2 bytes	0.00 - 99.99
231	Delay time of DI 12	2 bytes	0.00 - 99.99
232	Delay time of DI 13	2 bytes	0.00 - 99.99
233	Delay time of DI 14	2 bytes	0.00 - 99.99
234	Delay time of DI 15	2 bytes	0.00 - 99.99
235	Delay time of DI 16	2 bytes	0.00 - 99.99
236	Delay time of DI 17	2 bytes	0.00 - 99.99
237	Delay time of DI 18	2 bytes	0.00 - 99.99
238	Delay time of DI 19	2 bytes	0.00 - 99.99
239	Delay time of DI 20	2 bytes	0.00 - 99.99
240	Delay time of DI 21	2 bytes	0.00 - 99.99
241	Delay time of DI 22	2 bytes	0.00 - 99.99
242	Delay time of DI 23	2 bytes	0.00 - 99.99
243	Delay time of DI 24	2 bytes	0.00 - 99.99
244	Delay time of DI 25	2 bytes	0.00 - 99.99
245	Delay time of DI 26	2 bytes	0.00 - 99.99
246	Delay time of DI 27	2 bytes	0.00 - 99.99
247	Delay time of DI 28	2 bytes	0.00 - 99.99
248	Delay time of DI 29	2 bytes	0.00 - 99.99
249	Delay time of DI 30	2 bytes	0.00 - 99.99
250	Delay time of DI 31	2 bytes	0.00 - 99.99
251	Delay time of DI 32	2 bytes	0.00 - 99.99
252	Delay time of DI 33	2 bytes	0.00 - 99.99
253	Delay time of DI 34	2 bytes	0.00 - 99.99
254	Delay time of DI 35	2 bytes	0.00 - 99.99
255	Delay time of DI 36	2 bytes	0.00 - 99.99
256	Delay time of DI 37	2 bytes	0.00 - 99.99
257	Delay time of DI 38	2 bytes	0.00 - 99.99
258	Delay time of DI 39	2 bytes	0.00 - 99.99
259	Delay time of DI 40	2 bytes	0.00 - 99.99
260	Delay time of DI 41	2 bytes	0.00 - 99.99
261	Delay time of DI 42	2 bytes	0.00 - 99.99
262	Delay time of DI 43	2 bytes	0.00 - 99.99

## Holding register 6/13

Address	Name		Size	Output range
263	Setting of stop	High order	4 bytes	0 – 4294967296
265	Setting of stop	Low order	4 bytes	0 – 4294967296
267	Setting of DO BZ	High order	4 bytes	0 – 4294967296
269	Setting of DO BZ	Low order	4 bytes	0 – 4294967296
271	Setting of DO 1	High order	4 bytes	0 – 4294967296
273	Setting of DO 1	Low order	4 bytes	0 – 4294967296
275	Setting of DO 2	High order	4 bytes	0 – 4294967296
277	Setting of DO 2	Low order	4 bytes	0 – 4294967296
279	Setting of DO 3	High order	4 bytes	0 – 4294967296
281	Setting of DO 3	Low order	4 bytes	0 – 4294967296
283	Setting of DO 4	High order	4 bytes	0 – 4294967296
285	Setting of DO 4	Low order	4 bytes	0 – 4294967296
287	Setting of DO 5	High order	4 bytes	0 – 4294967296
289	Setting of DO 5	Low order	4 bytes	0 – 4294967296
291	Setting of DO 6	High order	4 bytes	0 – 4294967296
293	Setting of DO 6	Low order	4 bytes	0 – 4294967296
295	Setting of DO 7	High order	4 bytes	0 – 4294967296
297	Setting of DO 7	Low order	4 bytes	0 – 4294967296
299	Setting of DO 8	High order	4 bytes	0 – 4294967296
301	Setting of DO 8	Low order	4 bytes	0 – 4294967296
303	Setting of DO 9	High order	4 bytes	0 – 4294967296
305	Setting of DO 9	Low order	4 bytes	0 – 4294967296
307	Setting of DO 10	High order	4 bytes	0 – 4294967296
309	Setting of DO 10	Low order	4 bytes	0 – 4294967296
311	Setting of DO 11	High order	4 bytes	0 – 4294967296
313	Setting of DO 11	Low order	4 bytes	0 – 4294967296
315	Setting of DO 12	High order	4 bytes	0 – 4294967296
317	Setting of DO 12	Low order	4 bytes	0 – 4294967296
319	Setting of DO 13	High order	4 bytes	0 – 4294967296
321	Setting of DO 13	Low order	4 bytes	0 – 4294967296
323	Setting of DO 14	High order	4 bytes	0 – 4294967296
325	Setting of DO 14	Low order	4 bytes	0 – 4294967296
327	Setting of DO 15	High order	4 bytes	0 – 4294967296
329	Setting of DO 15	Low order	4 bytes	0 – 4294967296
331	Setting of DO 16	High order	4 bytes	0 – 4294967296
333	Setting of DO 16	Low order	4 bytes	0 – 4294967296
335	Setting of DO 17	High order	4 bytes	0 – 4294967296
337	Setting of DO 17	Low order	4 bytes	0 – 4294967296
339	Setting of DO 18	High order	4 bytes	0 – 4294967296
341	Setting of DO 18	Low order	4 bytes	0 – 4294967296
343	Setting of DO 19	High order	4 bytes	0 – 4294967296
345	Setting of DO 19	Low order	4 bytes	0 – 4294967296
347	Setting of DO 20	High order	4 bytes	0 – 4294967296
349	Setting of DO 20	Low order	4 bytes	0 – 4294967296



## Holding register 7/13

Address	Name		Size	Output range
351	Setting of DO 21	High order	4 bytes	0 – 4294967296
353	Setting of DO 21	Low order	4 bytes	0 – 4294967296
355	Setting of DO 22	High order	4 bytes	0 – 4294967296
357	Setting of DO 22	Low order	4 bytes	0 – 4294967296
359	Setting of DO 23	High order	4 bytes	0 – 4294967296
361	Setting of DO 23	Low order	4 bytes	0 – 4294967296
363	Setting of DO 24	High order	4 bytes	0 – 4294967296
365	Setting of DO 24	Low order	4 bytes	0 – 4294967296
367	Setting of DO 25	High order	4 bytes	0 – 4294967296
369	Setting of DO 25	Low order	4 bytes	0 – 4294967296
371	Setting of DO 26	High order	4 bytes	0 – 4294967296
373	Setting of DO 26	Low order	4 bytes	0 – 4294967296
375	Setting of DO 27	High order	4 bytes	0 – 4294967296
377	Setting of DO 27	Low order	4 bytes	0 – 4294967296
379	Setting of DO 28	High order	4 bytes	0 – 4294967296
381	Setting of DO 28	Low order	4 bytes	0 – 4294967296
383	Setting of DO 29	High order	4 bytes	0 – 4294967296
385	Setting of DO 29	Low order	4 bytes	0 – 4294967296
387	Setting of DO 30	High order	4 bytes	0 – 4294967296
389	Setting of DO 30	Low order	4 bytes	0 – 4294967296
391	Setting of DO 31	High order	4 bytes	0 – 4294967296
393	Setting of DO 31	Low order	4 bytes	0 – 4294967296
395	Setting of DO 32	High order	4 bytes	0 – 4294967296
397	Setting of DO 32	Low order	4 bytes	0 – 4294967296
399	Setting of DO 33	High order	4 bytes	0 – 4294967296
401	Setting of DO 33	Low order	4 bytes	0 – 4294967296
403	Setting of DO 34	High order	4 bytes	0 – 4294967296
405	Setting of DO 34	Low order	4 bytes	0 – 4294967296
407	Setting of DO 35	High order	4 bytes	0 – 4294967296
409	Setting of DO 35	Low order	4 bytes	0 – 4294967296
411	Setting of DO 36	High order	4 bytes	0 – 4294967296
413	Setting of DO 36	Low order	4 bytes	0 – 4294967296
415	Setting of DO 37	High order	4 bytes	0 – 4294967296
417	Setting of DO 37	Low order	4 bytes	0 – 4294967296
419	Setting of DO 38	High order	4 bytes	0 – 4294967296
421	Setting of DO 38	Low order	4 bytes	0 – 4294967296
423	Setting of DO 39	High order	4 bytes	0 – 4294967296
425	Setting of DO 39	Low order	4 bytes	0 – 4294967296
427	Setting of DO 40	High order	4 bytes	0 – 4294967296
429	Setting of DO 40	Low order	4 bytes	0 – 4294967296
431	Setting of DO 41	High order	4 bytes	0 – 4294967296
433	Setting of DO 41	Low order	4 bytes	0 – 4294967296
435	Setting of DO 42	High order	4 bytes	0 – 4294967296
437	Setting of DO 42	Low order	4 bytes	0 – 4294967296

## Holding register 8/13

Address	Name		Size	Output range
439	Setting of DO 43	High order	4 bytes	0 – 4294967296
441	Setting of DO 43	Low order	4 bytes	0 – 4294967296
443	Behavior of DO BZ		2 bytes	0 – 2
444	Behavior of DO 1		2 bytes	0 – 2
445	Behavior of DO 2		2 bytes	0 – 2
446	Behavior of DO 3		2 bytes	0 – 2
447	Behavior of DO 4		2 bytes	0 – 2
448	Behavior of DO 5		2 bytes	0 – 2
449	Behavior of DO 6		2 bytes	0 – 2
450	Behavior of DO 7		2 bytes	0 – 2
451	Behavior of DO 8		2 bytes	0 – 2
452	Behavior of DO 9		2 bytes	0 – 2
453	Behavior of DO 10		2 bytes	0 – 2
454	Behavior of DO 11		2 bytes	0 – 2
455	Behavior of DO 12		2 bytes	0 – 2
456	Behavior of DO 13		2 bytes	0 – 2
457	Behavior of DO 14		2 bytes	0 – 2
458	Behavior of DO 15		2 bytes	0 – 2
459	Behavior of DO 16		2 bytes	0 – 2
460	Behavior of DO 17		2 bytes	0 – 2
461	Behavior of DO 18		2 bytes	0 – 2
462	Behavior of DO 19		2 bytes	0 – 2
463	Behavior of DO 20		2 bytes	0 – 2
464	Behavior of DO 21		2 bytes	0 – 2
465	Behavior of DO 22		2 bytes	0 – 2
466	Behavior of DO 23		2 bytes	0 – 2
467	Behavior of DO 24		2 bytes	0 – 2
468	Behavior of DO 25		2 bytes	0 – 2
469	Behavior of DO 26		2 bytes	0 – 2
470	Behavior of DO 27		2 bytes	0 – 2
471	Behavior of DO 28		2 bytes	0 – 2
472	Behavior of DO 29		2 bytes	0 – 2
473	Behavior of DO 30		2 bytes	0 – 2
474	Behavior of DO 31		2 bytes	0 – 2
475	Behavior of DO 32		2 bytes	0 – 2
476	Behavior of DO 33		2 bytes	0 – 2
477	Behavior of DO 34		2 bytes	0 – 2
478	Behavior of DO 35		2 bytes	0 – 2
479	Behavior of DO 36		2 bytes	0 – 2
480	Behavior of DO 37		2 bytes	0 – 2
481	Behavior of DO 38		2 bytes	0 – 2
482	Behavior of DO 39		2 bytes	0 – 2
483	Behavior of DO 40		2 bytes	0 – 2
484	Behavior of DO 41		2 bytes	0 – 2

## Holding register 9/13

Address	Name	Size	Output range
485	Behavior of DO 42	2 bytes	0 – 2
486	Behavior of DO 43	2 bytes	0 – 2
487	Delay time of DO BZ	2 bytes	0.00 – 99.99
488	Delay time of DO 1	2 bytes	0.00 – 99.99
489	Delay time of DO 2	2 bytes	0.00 – 99.99
490	Delay time of DO 3	2 bytes	0.00 – 99.99
491	Delay time of DO 4	2 bytes	0.00 – 99.99
492	Delay time of DO 5	2 bytes	0.00 – 99.99
493	Delay time of DO 6	2 bytes	0.00 – 99.99
494	Delay time of DO 7	2 bytes	0.00 – 99.99
495	Delay time of DO 8	2 bytes	0.00 – 99.99
496	Delay time of DO 9	2 bytes	0.00 – 99.99
497	Delay time of DO 10	2 bytes	0.00 – 99.99
498	Delay time of DO 11	2 bytes	0.00 – 99.99
499	Delay time of DO 12	2 bytes	0.00 – 99.99
500	Delay time of DO 13	2 bytes	0.00 – 99.99
501	Delay time of DO 14	2 bytes	0.00 – 99.99
502	Delay time of DO 15	2 bytes	0.00 – 99.99
503	Delay time of DO 16	2 bytes	0.00 – 99.99
504	Delay time of DO 17	2 bytes	0.00 – 99.99
505	Delay time of DO 18	2 bytes	0.00 – 99.99
506	Delay time of DO 19	2 bytes	0.00 – 99.99
507	Delay time of DO 20	2 bytes	0.00 – 99.99
508	Delay time of DO 21	2 bytes	0.00 – 99.99
509	Delay time of DO 22	2 bytes	0.00 – 99.99
510	Delay time of DO 23	2 bytes	0.00 – 99.99
511	Delay time of DO 24	2 bytes	0.00 – 99.99
512	Delay time of DO 25	2 bytes	0.00 – 99.99
513	Delay time of DO 26	2 bytes	0.00 – 99.99
514	Delay time of DO 27	2 bytes	0.00 – 99.99
515	Delay time of DO 28	2 bytes	0.00 – 99.99
516	Delay time of DO 29	2 bytes	0.00 – 99.99
517	Delay time of DO 30	2 bytes	0.00 – 99.99
518	Delay time of DO 31	2 bytes	0.00 – 99.99
519	Delay time of DO 32	2 bytes	0.00 – 99.99
520	Delay time of DO 33	2 bytes	0.00 – 99.99
521	Delay time of DO 34	2 bytes	0.00 – 99.99
522	Delay time of DO 35	2 bytes	0.00 – 99.99
523	Delay time of DO 36	2 bytes	0.00 – 99.99
524	Delay time of DO 37	2 bytes	0.00 – 99.99
525	Delay time of DO 38	2 bytes	0.00 – 99.99
526	Delay time of DO 39	2 bytes	0.00 – 99.99
527	Delay time of DO 40	2 bytes	0.00 – 99.99
528	Delay time of DO 41	2 bytes	0.00 – 99.99

## Holding register 10/13

Address	Name	Size	Output range
529	Delay time of DO 42	2 bytes	0.00 – 99.99
530	Delay time of DO 43	2 bytes	0.00 – 99.99
531	Hold time of DO BZ	2 bytes	0.00 – 99.99
532	Hold time of DO 1	2 bytes	0.00 – 99.99
533	Hold time of DO 2	2 bytes	0.00 – 99.99
534	Hold time of DO 3	2 bytes	0.00 – 99.99
535	Hold time of DO 4	2 bytes	0.00 – 99.99
536	Hold time of DO 5	2 bytes	0.00 – 99.99
537	Hold time of DO 6	2 bytes	0.00 – 99.99
538	Hold time of DO 7	2 bytes	0.00 – 99.99
539	Hold time of DO 8	2 bytes	0.00 – 99.99
540	Hold time of DO 9	2 bytes	0.00 – 99.99
541	Hold time of DO 10	2 bytes	0.00 – 99.99
542	Hold time of DO 11	2 bytes	0.00 – 99.99
543	Hold time of DO 12	2 bytes	0.00 – 99.99
544	Hold time of DO 13	2 bytes	0.00 – 99.99
545	Hold time of DO 14	2 bytes	0.00 – 99.99
546	Hold time of DO 15	2 bytes	0.00 – 99.99
547	Hold time of DO 16	2 bytes	0.00 – 99.99
548	Hold time of DO 17	2 bytes	0.00 – 99.99
549	Hold time of DO 18	2 bytes	0.00 – 99.99
550	Hold time of DO 19	2 bytes	0.00 – 99.99
551	Hold time of DO 20	2 bytes	0.00 – 99.99
552	Hold time of DO 21	2 bytes	0.00 – 99.99
553	Hold time of DO 22	2 bytes	0.00 – 99.99
554	Hold time of DO 23	2 bytes	0.00 – 99.99
555	Hold time of DO 24	2 bytes	0.00 – 99.99
556	Hold time of DO 25	2 bytes	0.00 – 99.99
557	Hold time of DO 26	2 bytes	0.00 – 99.99
558	Hold time of DO 27	2 bytes	0.00 – 99.99
559	Hold time of DO 28	2 bytes	0.00 – 99.99
560	Hold time of DO 29	2 bytes	0.00 – 99.99
561	Hold time of DO 30	2 bytes	0.00 – 99.99
562	Hold time of DO 31	2 bytes	0.00 – 99.99
563	Hold time of DO 32	2 bytes	0.00 – 99.99
564	Hold time of DO 33	2 bytes	0.00 – 99.99
565	Hold time of DO 34	2 bytes	0.00 – 99.99
566	Hold time of DO 35	2 bytes	0.00 – 99.99
567	Hold time of DO 36	2 bytes	0.00 – 99.99
568	Hold time of DO 37	2 bytes	0.00 – 99.99
569	Hold time of DO 38	2 bytes	0.00 – 99.99
570	Hold time of DO 39	2 bytes	0.00 – 99.99
571	Hold time of DO 40	2 bytes	0.00 – 99.99
572	Hold time of DO 41	2 bytes	0.00 – 99.99

## Holding register 11/13

Address	Name	Size	Output range
573	Hold time of DO 42	2 bytes	0.00 – 99.99
574	Hold time of DO 43	2 bytes	0.00 – 99.99
575	Polarity of DO BZ	2 bytes	0.00 – 99.99
576	Polarity of DO 1	2 bytes	0 – 1
577	Polarity of DO 2	2 bytes	0 – 1
578	Polarity of DO 3	2 bytes	0 – 1
579	Polarity of DO 4	2 bytes	0 – 1
580	Polarity of DO 5	2 bytes	0 – 1
581	Polarity of DO 6	2 bytes	0 – 1
582	Polarity of DO 7	2 bytes	0 – 1
583	Polarity of DO 8	2 bytes	0 – 1
584	Polarity of DO 9	2 bytes	0 – 1
585	Polarity of DO 10	2 bytes	0 – 1
586	Polarity of DO 11	2 bytes	0 – 1
587	Polarity of DO 12	2 bytes	0 – 1
588	Polarity of DO 13	2 bytes	0 – 1
589	Polarity of DO 14	2 bytes	0 – 1
590	Polarity of DO 15	2 bytes	0 – 1
591	Polarity of DO 16	2 bytes	0 – 1
592	Polarity of DO 17	2 bytes	0 – 1
593	Polarity of DO 18	2 bytes	0 – 1
594	Polarity of DO 19	2 bytes	0 – 1
595	Polarity of DO 20	2 bytes	0 – 1
596	Polarity of DO 21	2 bytes	0 – 1
597	Polarity of DO 22	2 bytes	0 – 1
598	Polarity of DO 23	2 bytes	0 – 1
599	Polarity of DO 24	2 bytes	0 – 1
600	Polarity of DO 25	2 bytes	0 – 1
601	Polarity of DO 26	2 bytes	0 – 1
602	Polarity of DO 27	2 bytes	0 – 1
603	Polarity of DO 28	2 bytes	0 – 1
604	Polarity of DO 29	2 bytes	0 – 1
605	Polarity of DO 30	2 bytes	0 – 1
606	Polarity of DO 31	2 bytes	0 – 1
607	Polarity of DO 32	2 bytes	0 – 1
608	Polarity of DO 33	2 bytes	0 – 1
609	Polarity of DO 34	2 bytes	0 – 1
610	Polarity of DO 35	2 bytes	0 – 1
611	Polarity of DO 36	2 bytes	0 – 1
612	Polarity of DO 37	2 bytes	0 – 1
613	Polarity of DO 38	2 bytes	0 – 1
614	Polarity of DO 39	2 bytes	0 – 1
615	Polarity of DO 40	2 bytes	0 – 1
616	Polarity of DO 41	2 bytes	0 – 1

## Holding register 12/13

Address	Name	Size	Output range
617	Polarity of DO 42	2 bytes	0 – 1
618	Polarity of DO 43	2 bytes	0 – 1
619	Decimal point	2 bytes	0 – 4
620	Division	2 bytes	0 – 5
621	Capacity	4 bytes	0.0000 – 99999.9999
623	Zero point range	2 bytes	0 – 30
624	Power-on auto zero range	2 bytes	0 – 100
625	Zero tracking time	2 bytes	0.0 – 9.9
626	Zero tracking weight	2 bytes	0 – 9
627	Stability time (to regard as stable weighing value)	2 bytes	0.0 – 9.9
628	Stability weight (to regard as stable weighing value)	2 bytes	0 – 9
629	Weight value	4 bytes	0.0000 – 99999.9999
631	Weighing mode	2 bytes	0 – 2
632	Negative weight	2 bytes	0 – 1
633	Display data	2 bytes	0 – 1
634	Do not use address because of reserved expansion number.	2 bytes	
635		2 bytes	
636	Unsplit range	2 bytes	0 – 100
637	Curb chattering	2 bytes	0.00 – 99.99
638	Photo eye sensor polarity	2 bytes	0 – 1
639	Photo eye sensor time out	2 bytes	0.00 – 99.99
640	Priority of peripherals	2 bytes	0 – 1
641	Digital Filter (Static)	2 bytes	0 – 9
642	Save operation history to USB	2 bytes	0 – 1
643	Save weighing history to USB	2 bytes	0 – 1
644	Reject stage	2 bytes	0 – 1
645	Target	4 bytes	0.0000 – 99999.9999
647	HiHi limit	4 bytes	0.0000 – 99999.9999
649	Hi limit	4 bytes	0.0000 – 99999.9999
651	Lo limit	4 bytes	0.0000 – 99999.9999
653	LoLo limit	4 bytes	0.0000 – 99999.9999
655	Over weight exception	2 bytes	0 – 1
656	Consecutive fail stop	2 bytes	0 – 1
657	Consecutive fail num	2 bytes	0 – 9999
658	Product length	2 bytes	30 – 999
659	Speed	2 bytes	10 – 120
660	Do not use address because of reserved expansion number.	2 bytes	
661		2 bytes	
662		2 bytes	
663		2 bytes	
664		2 bytes	
665		2 bytes	
666		2 bytes	
667		4 bytes	

## Holding register 13/13

Address	Name	Size	Output range
669	Num of samples	2 bytes	2 – 9999
670	Sub sample	2 bytes	2 – 10
671	$\bar{X}$	4 bytes	0.0000 – 99999.9999
673	$\bar{R}$	4 bytes	0.0000 – 99999.9999
675	Width of Section	4 bytes	0.0000 – 99999.9999
677	Auto zero range	4 bytes	0.0000 – 99999.9999
679	Dead zone timer of auto zero	2 bytes	0.0 – 999.9
680	Observation timer of auto zero	2 bytes	0.00 – 99.99
681	Averaging time of auto zero	2 bytes	0.00 – 99.99
682	Auto zero samples	2 bytes	1 – 100
683	Coe of auto zero	2 bytes	0 – 100
684	Do not use address because of reserved expansion number.	2 bytes	0 – 1
685	D. comp value (Dynamic compensation value)	4 bytes	0.50000 – 2.00000
687	Tare	4 bytes	0.0000 – 99999.9999
689	Feedback control target	4 bytes	0.0000 – 99999.9999
691	Feedback control range	4 bytes	0.0000 – 99999.9999
693	Feedback control step [ g/sec ]	4 bytes	1.0000 – 100.0000
695	Feedback control step [ sec/g ]	4 bytes	0.0001 – 1.0000
697	Feedback control sample	2 bytes	1 – 999
698	Feedback control waiting time	2 bytes	0.0 – 999.9
699	Control target	4 bytes	0.0000 – 99999.9999
701	Zone 1	4 bytes	0.0000 – 99999.9999
703	Zone 2	4 bytes	0.0000 – 99999.9999
705	Zone 3	4 bytes	0.0000 – 99999.9999
707	Zone 4	4 bytes	0.0000 – 99999.9999
709	10C sample	2 bytes	1 – 999
710	10C wait time	2 bytes	0.0 – 999.9

## 10.6. Communication Command of Modbus TCP

### 10.6.1. Protocol Layout

When the request or response of Modbus are communicated using Modbus TCP, the format is shown below. Transaction identifier of slave side is used to return a copy only. Transaction identifier of master side is used to transaction management of messages. The following 6 byte information is added at the head of the request and response of Modbus TCP.

- Byte 0 : Transaction identifier, Slave only copies, usually 0
- Byte 1 : Transaction identifier, Slave only copies, usually 0
- Byte 2 : Transaction identifier = 0
- byte 3 : Transaction identifier = 0
- Byte 4 : Length (High-order byte) = 0 (Because all messages are under 256.)
- Byte 5 : Length (Low-order byte) = Number of following bytes
- Byte 6 : Slave address
- Byte 7 : Modbus function

Byte 8 or later : Required data sequence

Relationship of data construction of message for Modbus TCP and Modbus is as follows :

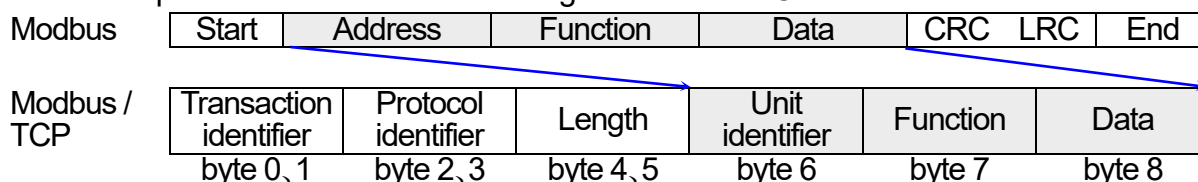

### 10.6.2. Example of Reading Input Register

This example describes concerning communication command in Modbus TCP.

The input register is read the same conditions of the "[10.3.1. Example of Reading Input Register](#)". Example of transmission command and example of response processed properly are shown below.

#### Cautions

- Error check is not necessary for Modbus TCP.

#### Transmission Command

#### Response

Command description	Transmission data
Transaction identifier	0x00
Transaction identifier	0x00
Protocol identifier	0x00
Protocol identifier	0x00
Field length (high-order)	0x00
Field length (low-order)	0x06
Slave address	0x01
Function code	0x04
Start address (high-order)	0x00
Start address (low-order)	0x2C
Number of register (high-order)	0x00
Number of register (low-order)	0x02

Command description	Response data
Transaction identifier	0x00
Transaction identifier	0x00
Protocol identifier	0x00
Protocol identifier	0x00
Field length (high-order)	0x00
Field length (low-order)	0x06
Slave address	0x01
Function code	0x04
Start address (high-order)	0x00
Start address (low-order)	0x2C
Number of register (high-order)	0x00
Number of register (low-order)	0x02

Table 20 Example of the transmission command (Reading of input register)

Table 21 Example of the response (Reading of input register)



# 11. Interface

## 11.1. Control I/O

The control I/O is the interface to input and/or output bit information between this indicator and connected peripherals, and equips 11 points of DO and 11 points of DI.

**Table 22 Specifications of the control I/O interface**

Input Circuit	DC Input (Source)
Open voltage of input terminal	7 to 11 V
Current of input terminal	5 mA (Maximum)
Tolerance saturation voltage	2 V (Maximum)
Output Circuit	Open collector
Maximum output voltage	DC 40 V
Maximum output current	50 mA
Tolerance saturation voltage	1.5 V ( at 50 mA drive current)

### 11.1.1. Connection of Control I/O

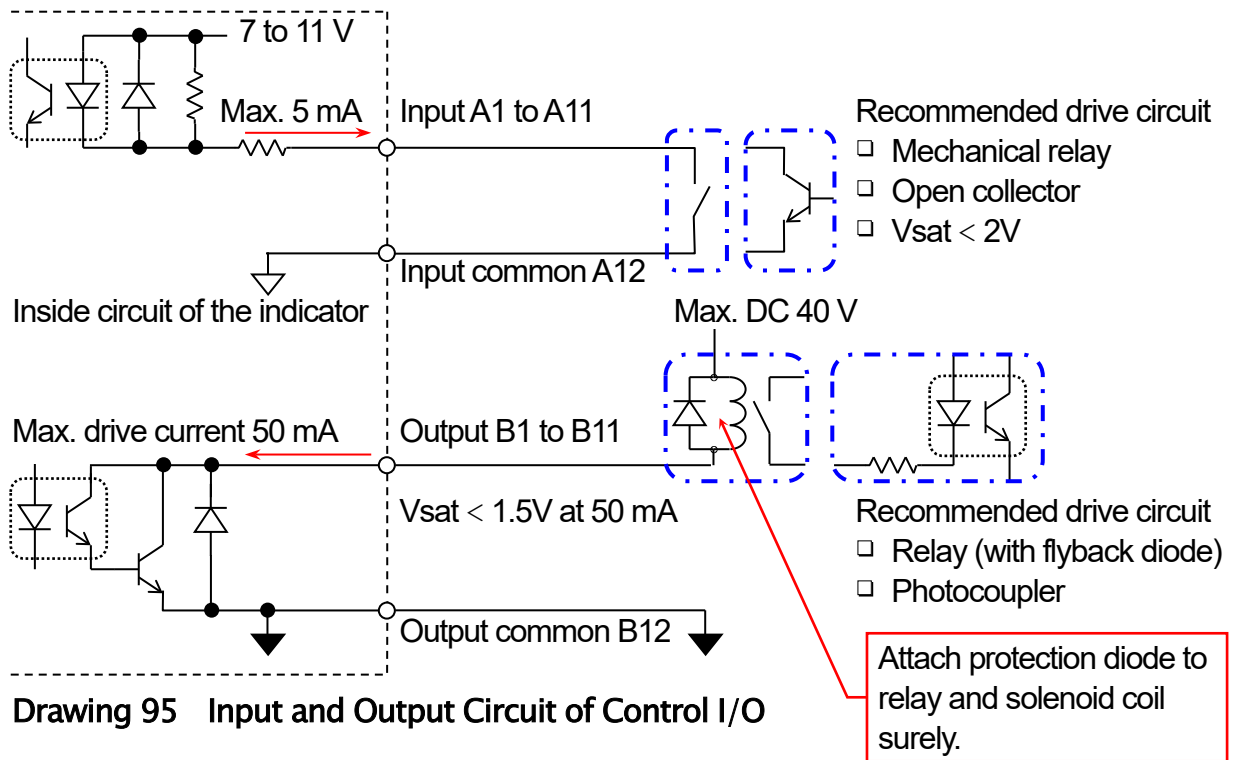

**Drawing 95 Input and Output Circuit of Control I/O**

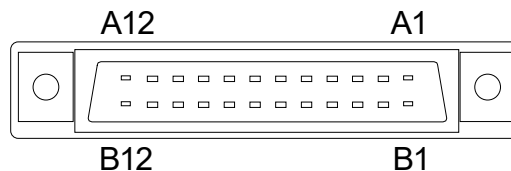

**Drawing 96 Terminals of Control I/O Connector**

**Table 23 DI and DO terminals on the control I/O**

Input terminal	DI number	Output terminal	DO number
A1	DI 1	B1	DO 1
A2	DI 2	B2	DO 2
A3	DI 3	B3	DO 3
A4	DI 4	B4	DO 4
A5	DI 5	B5	DO 5
A6	DI 6	B6	DO 6
A7	DI 7	B7	DO 7
A8	DI 8	B8	DO 8
A9	DI 9	B9	DO 9
A10	DI 10	B10	DO 10
A11	DI 11	B11	DO 11
A12	DI common	B12	DO common

## 11.2. RS-232C

The RS-232C interface is used to communication with printer, bar code reader and computer.

**Table 24 Specifications of RS-232C Interface**

Transmission form	EIA RS-232C Conformed
Data length	7 bit, 8 bit
Start bit	1 bit
Parity	Even 1 bit ,Odd 1 bit, None
Stop bit	1 bit, 2 bit
Baud rate	2400, 4800, 9600, 19200, 38400, 57600, 115200
Code	ASCII code

### 11.2.1. Connection of RS-232C

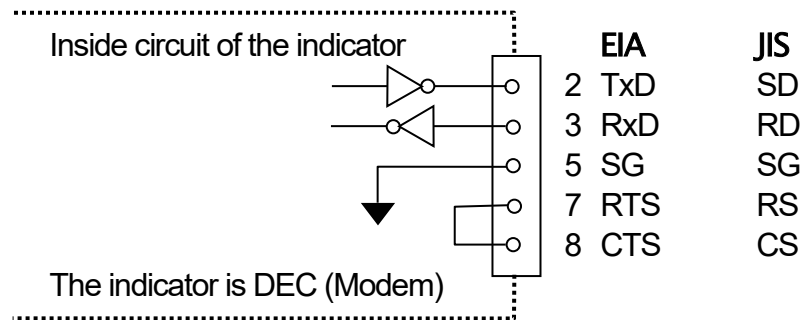

**Drawing 97 RS-232C Internal Circuit**

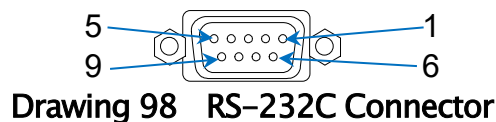

**Drawing 98 RS-232C Connector**

## 11.3. RS-485

The RS-485 interface is used to communication with PLC on Modbus RTU and to stream mode with computer.

- Terminal resistor needs surely for RS-485. Install terminal resistor between + terminal and - terminal at the longest position from transmission terminal. (Terminal resistor is not included to accessory.)
- Polarity of terminals on some host device may be reversed.
- If signal ground terminal is not equipped, SG terminal is not used.
- Connect the shield wire to the FG terminal if you use shielded cable.

**Table 25 Specifications of RS-485 Interface**

Transmission form	EIA RS-485 Conformed
Data length	7 bit, 8 bit
Start bit	1 bit
Parity	Even 1 bit ,Odd 1 bit, None
Stop bit	1 bit, 2 bit
Baud rate	2400, 4800, 9600, 19200, 38400, 57600, 115200
Line type	Differential line × 2
Code	ASCII code

### 11.3.1. Connection of RS-485

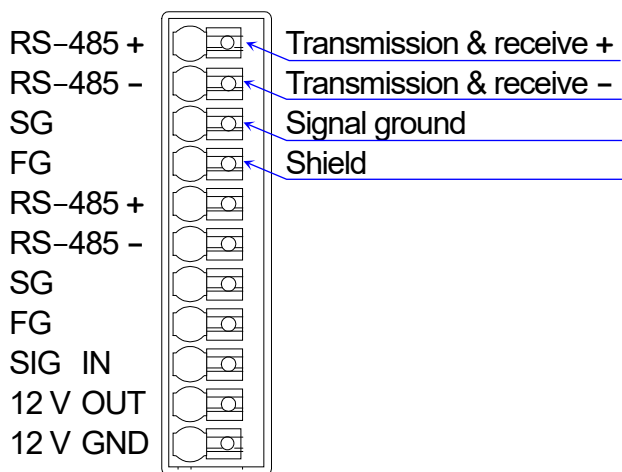

**Drawing 99 Terminals of RS-485 Connector**

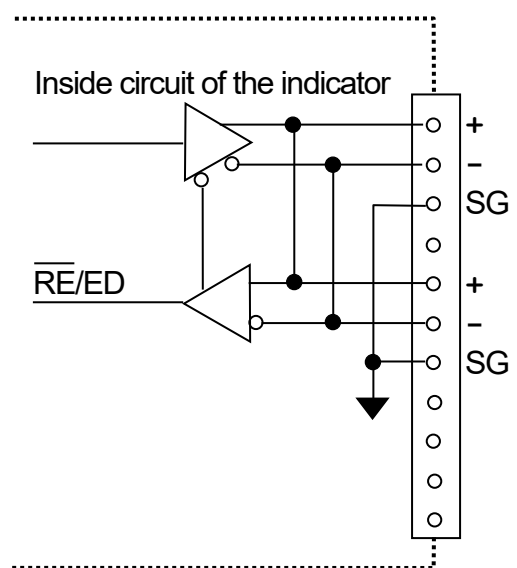

**Drawing 100 RS-485 Inside Circuit**

## 11.4. Photo Eye Sensor

The interface is used to photo eye sensor.

The connection of photo eye sensor is used on the terminal of terminal box principally. Additionally, it can be used on the terminal of this connector, too.

### 11.4.1. Connection of Photo Eye Sensor

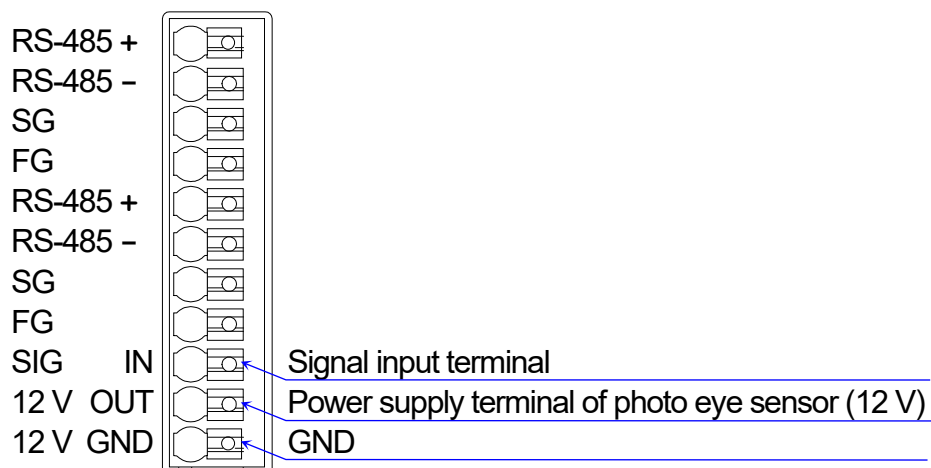

Drawing 101 Terminal of Photo eye sensor

## 11.5. OP-02 Relay Output

OP-02 relay output is an option equipped mechanical contact of DO 9 which has the same as function to the control I/O.

Table 26 OP-02 Specifications of Relay Output Interface

Output circuit	Mechanical contact relay		
Rated load	250 VAC	3 A	at rated load
	30 VDC	3 A	at rated load
Current at common terminal	10 A DC		at maximum
Minimum load	100 mV	100 $\mu$ A	
Mechanical lifetime	20,000,000 times or more	at no load	
Electrical lifetime	100,000 times or more	at rated load	

### Cautions

- OP-02 relay output and OP-05 parallel I/O can install into the indicator up to total 2 options. Address number of DI and DO are changed to number adapted to slot installed.
- When OP-02 is installed to slot 1, DO 12 to DO 20 are assigned as address numbers. When OP-02 is installed to slot 2, DO 28 to DO 36 are assigned as address numbers.

Table 27 Accessory of OP-02 Relay Output

Name	Pieces	Descriptions	
Relay output connector	1	1TMFKC2.5/11STF	Phoenix contact

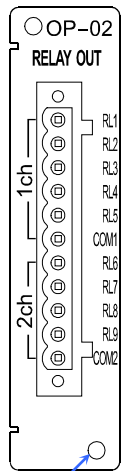

**Screw hole**  
When option is installed, confirm that screw is fixed.

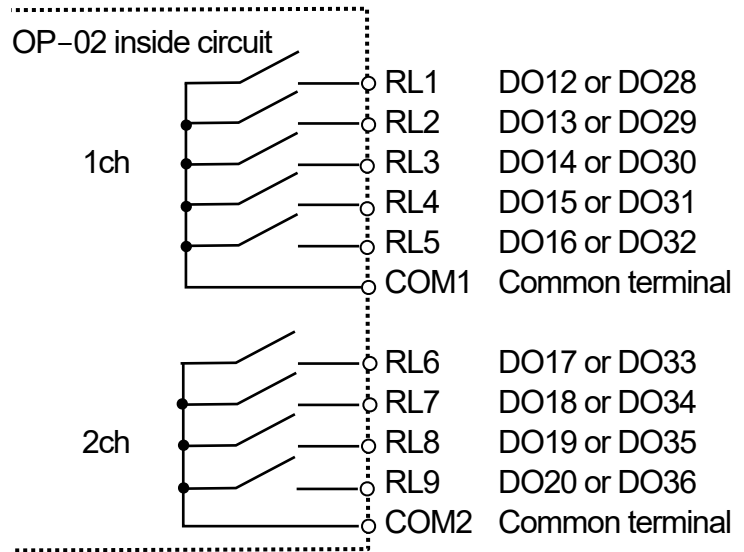

Drawing 102 Terminal of OP-02 connector

Drawing 103 OP-02 Output Circuit

Table 28 DO terminals on the OP-02 Relay Output

Output terminal	DO number on option slot 1	DO number on option slot 2	
1 ch	RL1	DO 12	DO 28
	RL2	DO 13	DO 29
	RL3	DO 14	DO 30
	RL4	DO 15	DO 31
	RL5	DO 16	DO 32
	COM1	Common terminal	
2 ch	RL6	DO 17	DO 33
	RL7	DO 18	DO 34
	RL8	DO 19	DO 35
	RL9	DO 20	DO 36
	COM2	Common terminal	

## 11.6. OP-05 Parallel Input / Output

OP-05 parallel input / output is the option to expand the control I/O.

These terminals can use the same as the control I/O.

Timing of input and output is the same as the control I/O, too.

**Table 29 Specifications of the OP-05 Parallel Input / Output**

Input Circuit	None voltage input / open collector drive
Open voltage of input terminal	7 to 11 V
Current of input terminal	5 mA (Maximum)
Tolerance saturation voltage	2 V (Maximum)
Output Circuit	Open collector
Maximum output voltage	DC 40 V
Maximum output current	50 mA
Tolerance saturation voltage	1.5 V ( at 50 mA drive current)

### Cautions

- OP-02 relay output and OP-05 parallel I/O can install into the indicator up to total 2 options. Address number of DI and DO are changed to number adapted to slot installed.
- When OP-05 is installed to slot 1, DI 12 to DI 27 and DO 12 to DO 27 are assigned. When OP-05 is installed to slot 2, DI 28 to DI 43 and DO 28 to DO 43 are assigned.

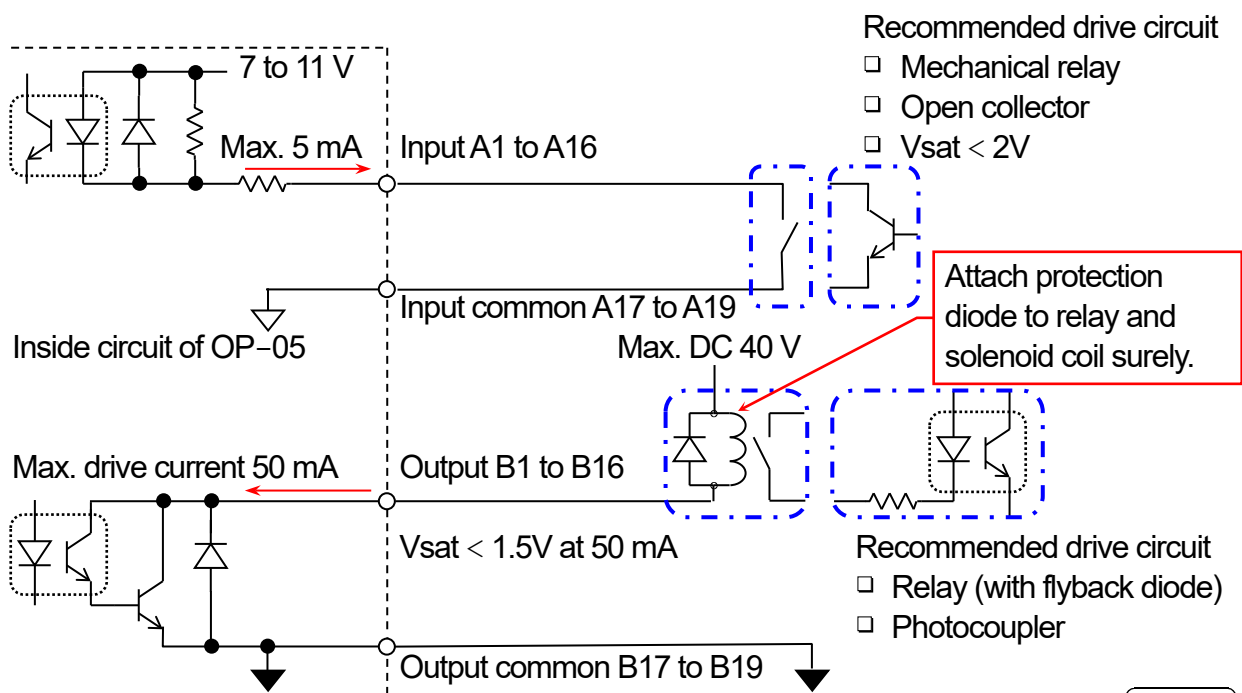

**Drawing 104 Input and Output Circuit of OP-05**

Screw hole  
When option is installed, confirm that screw is fixed.

**Drawing 105 Terminals of OP-05**

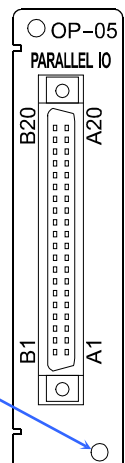

**Table 30 DI and DO terminals on the OP-05 parallel I/O**

Input terminal	DI number on option slot 1	DI number on option slot 2	Output terminal	DO number on option slot 1	DO number on option slot 2
A1	DI 12	DI 28	B1	DO 12	DO 28
A2	DI 13	DI 29	B2	DO 13	DO 29
A3	DI 14	DI 30	B3	DO 14	DO 30
A4	DI 15	DI 31	B4	DO 15	DO 31
A5	DI 16	DI 32	B5	DO 16	DO 32
A6	DI 17	DI 33	B6	DO 17	DO 33
A7	DI 18	DI 34	B7	DO 18	DO 34
A8	DI 19	DI 35	B8	DO 19	DO 35
A9	DI 20	DI 36	B9	DO 20	DO 36
A10	DI 21	DI 37	B10	DO 21	DO 37
A11	DI 22	DI 38	B11	DO 22	DO 38
A12	DI 23	DI 39	B12	DO 23	DO 39
A13	DI 24	DI 40	B13	DO 24	DO 40
A14	DI 25	DI 41	B14	DO 25	DO 41
A15	DI 26	DI 42	B15	DO 26	DO 42
A16	DI 27	DI 43	B16	DO 27	DO 43
A17	DI common	DI common	B17	DO common	DO common
A18					
A19					
A20	FG	FG	B20	FG	FG

## 11.7. OP-07 Analog Output

OP-07 analog output is the option to output 4 - 20 mA or 0 - 10 V adapted to weighing data etc.

**Table 31 Specifications of the OP-07 Analog Output**

Output form	4 - 20 mA current output (Range : 2 - 22 mA) 0 - 10 V voltage output
Maximum output voltage	11 V min. (at current output) / 10 V (at voltage output)
Resistor	0 to 500 $\Omega$ (at current output) / 560 $\Omega$ or more (at voltage output)
Output rate	200 time / s
Zero temperature coefficient	$\pm 150$ ppm/ $^{\circ}\text{C}$ (max.)
Span temperature coefficient	$\pm 150$ ppm/ $^{\circ}\text{C}$ (max.)
Non-linearity	0.1 % (max.)
Resolution	Smallest value of 40000 or readability

**Table 32 Accessory of the OP-07 Analog Output**

Name	Pieces	Descriptions
Relay output connector	1	1TMFKC2.5/12STF Phoenix Contact

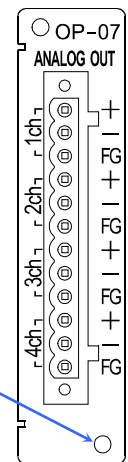

**Screw hole**  
When option is installed, confirm that screw is fixed.

**Drawing 106 Terminal of OP-07 connector**

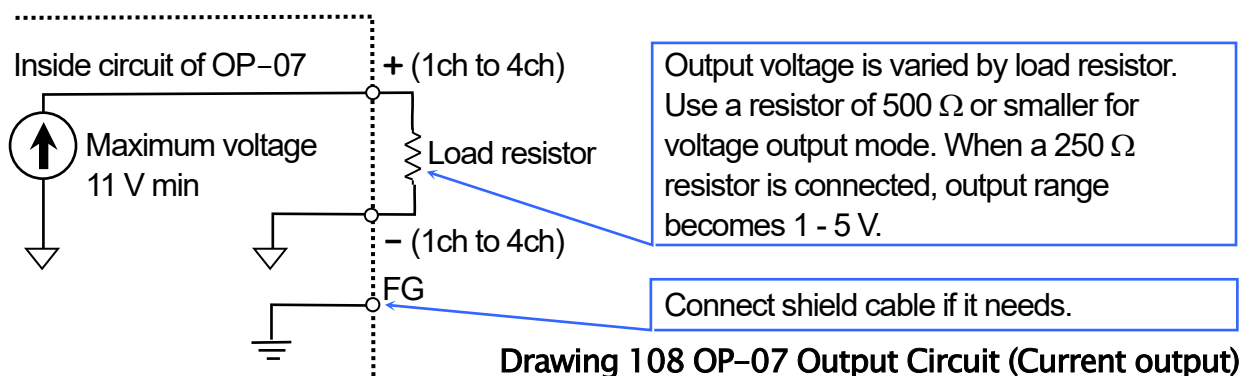
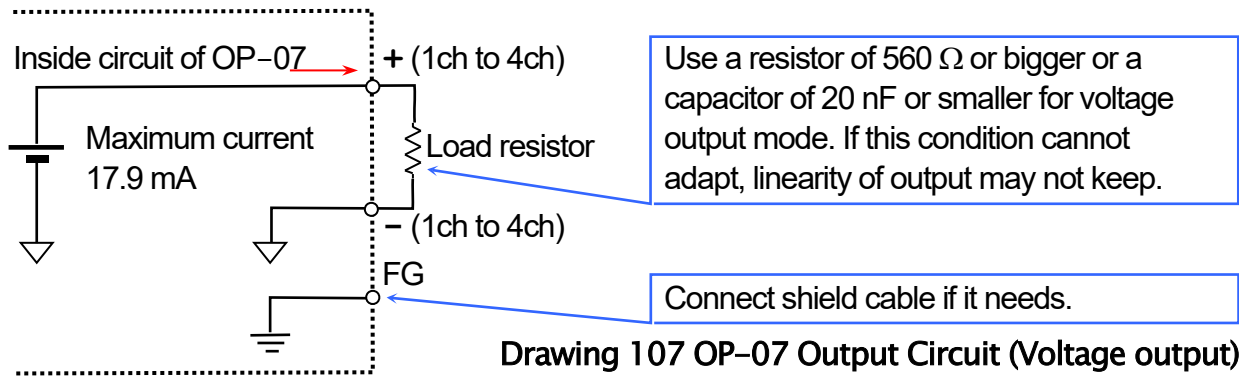



### 11.7.1. The Way to Set Output Current

Rate of analog output can arrange using low output value and high output value. This value can select weight value or conveyor velocity.

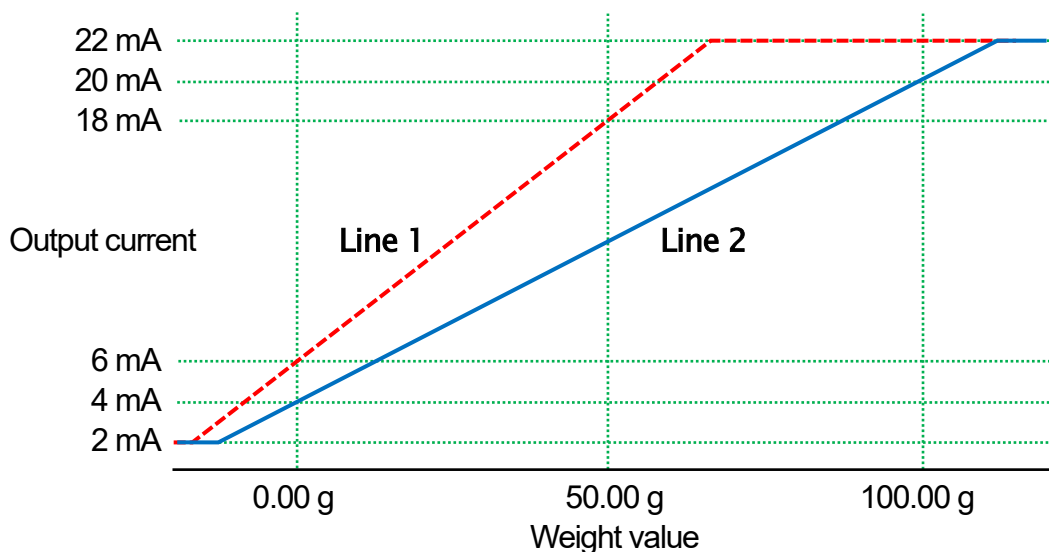

**Drawing 109 Example of the Settings of OP-07 (Current output by weight value)**

Example **Line 1** Low current standard = 6 mA  
 High current standard = 18 mA  
 Low current output = 0.00 g  
 High current output = 50.00 g are specified.

**Line 2** Low current standard = 4 mA  
 High current standard = 20 mA  
 Low current output = 0.00 g  
 High current output = 100.00 g are specified.

**Note**

- Additionally, it can arrange conveyor velocity to current value and weight value to voltage output.

## 11.8. OP-17 Additional Analog Output Module

OP-17 analog output is the option to output 4 - 20 mA or 0 -10 V adapted to weighing data etc.

## 12. Maintenance

This chapter describes for maintenance and management of the indicator.

### 12.1. Error Messages of Indicator

When an error occurs in the indicator, error message is displayed in window.

When error message is displayed, treat error using the following table.

#### 12.1.1. Error Message Table

Error message	Probable cause	Remedial action
Calibration weight error. The weight value is not within the span adjustment range.	Calibration weight is different.	Use the correct calibration weight. Perform the calibration again.
	The span weight is not put on the conveyor correctly.	Put the span weight on the center of the conveyor. Perform the calibration again.
	Foreign matter is existed or is touched to on the conveyor.	Remove foreign matter and calibrate again.
Photo eye sensor error. Light of photo eye sensor is shaded for preset time or longer.	There is anything between LED light and receiver of photo eye sensor.	Remove anything between LED light and receiver of photo eye sensor
	Axis of LED light and receiver of photo eye sensor have deviation.	Match axis of LED light and axis of receiver of photo eye sensor.
Printer error. Communication to printer failed.	Connection error.	Confirm the connection between indicator and printer.

## 12.2. Backup of System Data

The system data (all product registration, settings of weighing, settings of system, settings of user data, statistical data of each product, operation history ) can store in USB flash drive. If necessary data is deleted due to mis-operation or system cannot perform correctly, system at the time stored can be resumed using stored data in USB flash drive. We recommend to save data of system periodically.

### Note

- Refer to "3.1.2. Removing USB Flash Drive" for how to remove the USB flash drive.
- Backup data has directory construction.  
Directory name is "Year Month Date Hour Minute AD4412".  
Example : When it stored at 2019/05/16/ 16:55, directory name is "201905161655AD4412".

### Cautions

- Do not change data and construction of backup data to prevent system error.

Step 1. Login to the system with user management level of "Quality manager" or greater.

Step 2. Connect the USB flash drive to the USB port in the indicator.

Step 3. When USB flash drive is connected, the USB mark is indicated on upper-right side of the window.

Step 4. Touch the "Setting" key  to display the common setting window.

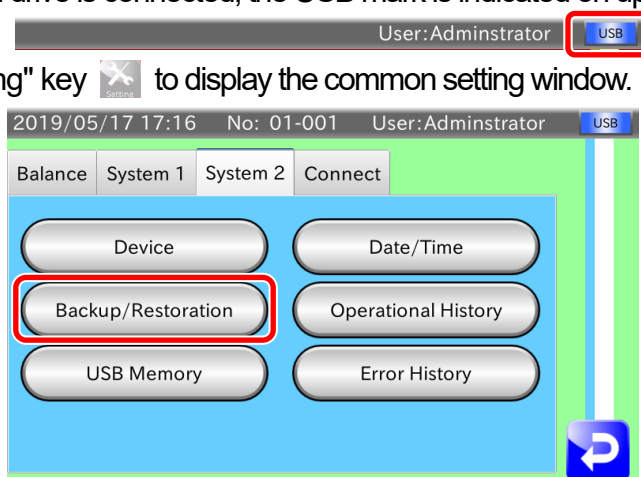

Drawing 110 Common Setting Window ( System tab2)

Step 5. Select "System 2" tab in the "Common setting window".

Touch the "Backup/Restoration" key.

Step 6. The "Backup/Restoration Window" is displayed. Touch the "Backup" key.

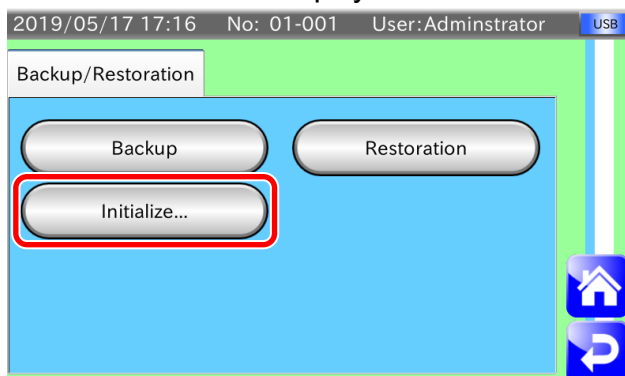

Drawing 111 Backup / Restoration Window

Step 7. The "Check text box" is displayed. Touch the "YES" key to store system data.

Step 8. After backup has finished, touch the "Home" key  to return to the "Weighing window".

## 12.3. Restoring System Data

The procedure to restore data stored using the "12.2. Backup of System Data" is shown below.

### Cautions

- When the restoration of data is performed, updated data from backup to this restoration is lost.

### Note

- Refer to "3.1.2. Removing USB Flash Drive" for how to remove the USB flash drive.

Step 1. Login to the system with user management level of "Quality manager" or greater.

Step 2. Connect the USB flash drive stored backup data to the USB port in the indicator.

Step 3. When USB flash drive is connected, the USB mark is indicated on upper-right side of the window.



Step 4. Touch the "Setting" key  to display the common setting window.

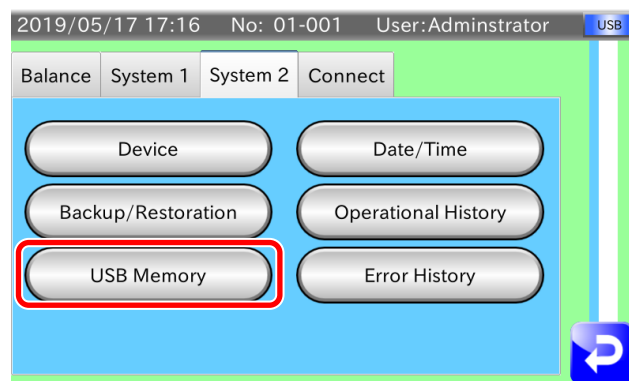

**Drawing 112 Common Setting Window ( System tab2)**

Step 5. Select "System 2" tab in the "Common setting window".  
Touch the "Backup/Restoration" key.

Step 6. The "Backup/Restoration Window" is displayed.  
Touch the "Restoration" key.

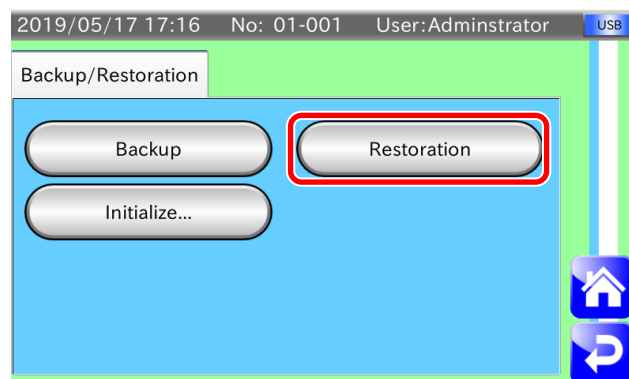

**Drawing 113 Backup / Restoration Window**

Step 7. The restoration dialog box is displayed. Select a backup file in the directory of system data and touch the "OK" key .

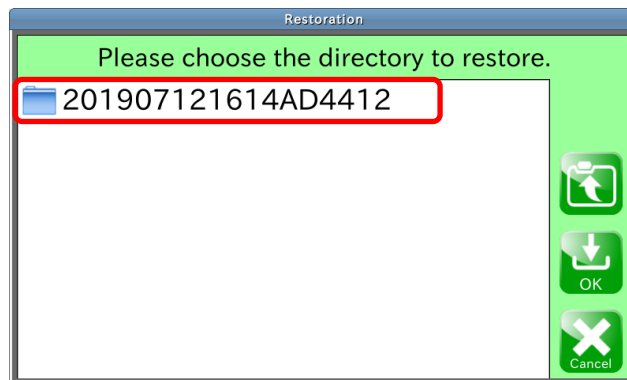

**Drawing 114 Restoration dialog box**

Step 8. Select type of restoration in the "Restoration check dialog box".

1. All settings  
The settings that includes calibration data (zero point, span), motor calibration data. It is used for restoration of the indicator using backup data.
2. Partial settings  
The settings except calibration data (zero point, span), motor calibration data. It can use to copy stored settings to other device.

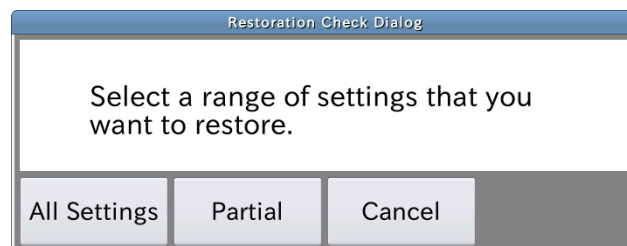

**Drawing 115 Restoration check dialog box**

Step 9. The check dialog box is displayed. Touch the "YES" key to restore it. If not, touch the "NO".

Step 10. The message is displayed after the restoration. Turn off the indicator and turn on to restart.

## 12.4. Initialization to Factory Settings

The procedure to reset to factory settings is shown below.

### Cautions

- When the factory settings is restored into the indicator, product information, weighing history, calibration data and system data stored the indicator are lost.
- Established parameters of wireless LAN are not initialized.

Step 1. Login to the system with user management level of "Quality manager" or greater.

Step 2. Touch the "Setting" key  to display the common setting window.

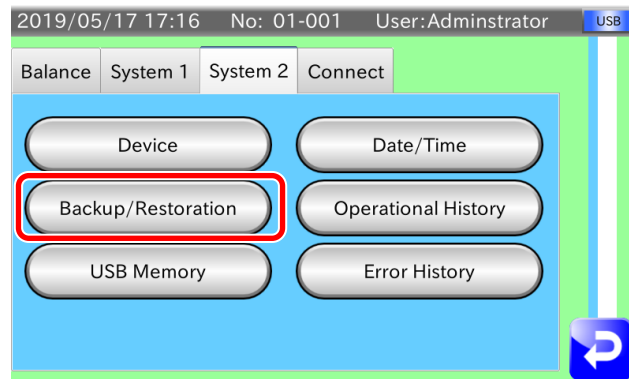

Drawing 116 Common Setting Window ( System tab2)

Step 3. Select "System 2" tab in the "Common setting window".

Touch the "Backup/Restoration" key.

Step 4. The "Backup/Restoration Window" is displayed. Touch the "Initialize..." key.

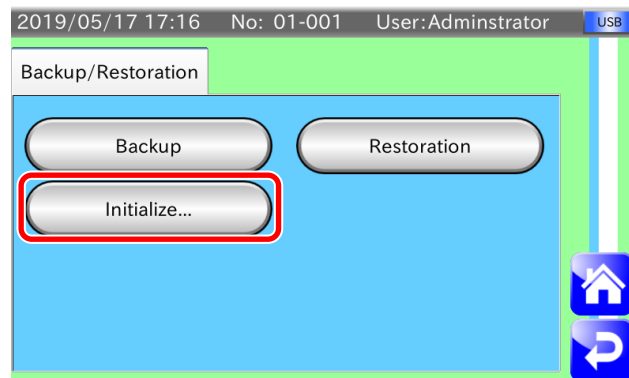

Drawing 117 Backup / Restoration Window

Step 5. The "factory settings dialog box" is displayed. Touch the "YES" key to store them.

Step 6. The message is displayed after factory settings is stored. Turn off the indicator and turn on to restart.

## 13. Specifications

	AD-4412-CW	AD-4413-CW
Load cell excitation voltage	DC 5 V, 60 mA with remote sense / Maximum 4 x 350 Ω load cells	
Input sensitivity	0.15 μV/d or greater	
Display resolution	999999 d	
Zero range	±7 mV/V (±35 mV)	
Zero temperature coefficient	±0.02 μV/C° (typ. , Excluding dead load)	
Span temperature coefficient	±3 ppm/C° (typ.)	
Non-Linearity	±50 ppm F.S. (typ.)	
Maximum input voltage	±7 mV/V (±35 mV)	
Display	7 inch LCD with touch panel	
Operation	Touch panel	
Number of products registration	1000	10 group x 100 kinds
Communication function	RS-232C RS-485 LAN USB	Computer / Dot impact printer etc. Modbus RTU ModbusTCP / Printer USB flash drive, data registration and image capture
Number of digital input	11 points	(None voltage input / open collector drive)
Number of digital output	11 points	(Open collector output)
Extension port	OP-02 OP-05 OP-07	Relay output 9 points Parallel I/O DI 16 points, DO16 points Maximum 4 analog output
Power supply of photo eye sensor I/F	12 V 250 mA 1 point	
Power source	100 – 240 VAC (+10 %, -15 %), 50 / 60Hz approximately 30 VA	
Operating temperature	-10 to 50 C°	
Operating humidity	20 to 85 %RH, no condensation	
Dust/water resistance	IP65 complied on panel	
Material	Front panel : PC + ABS resin Rear panel : PC + ABS resin	Front panel : Stainless steel Rear panel : PC + ABS resin

d : digit

# 13.1. Dimensions

## 13.1.1. AD-4412-CW

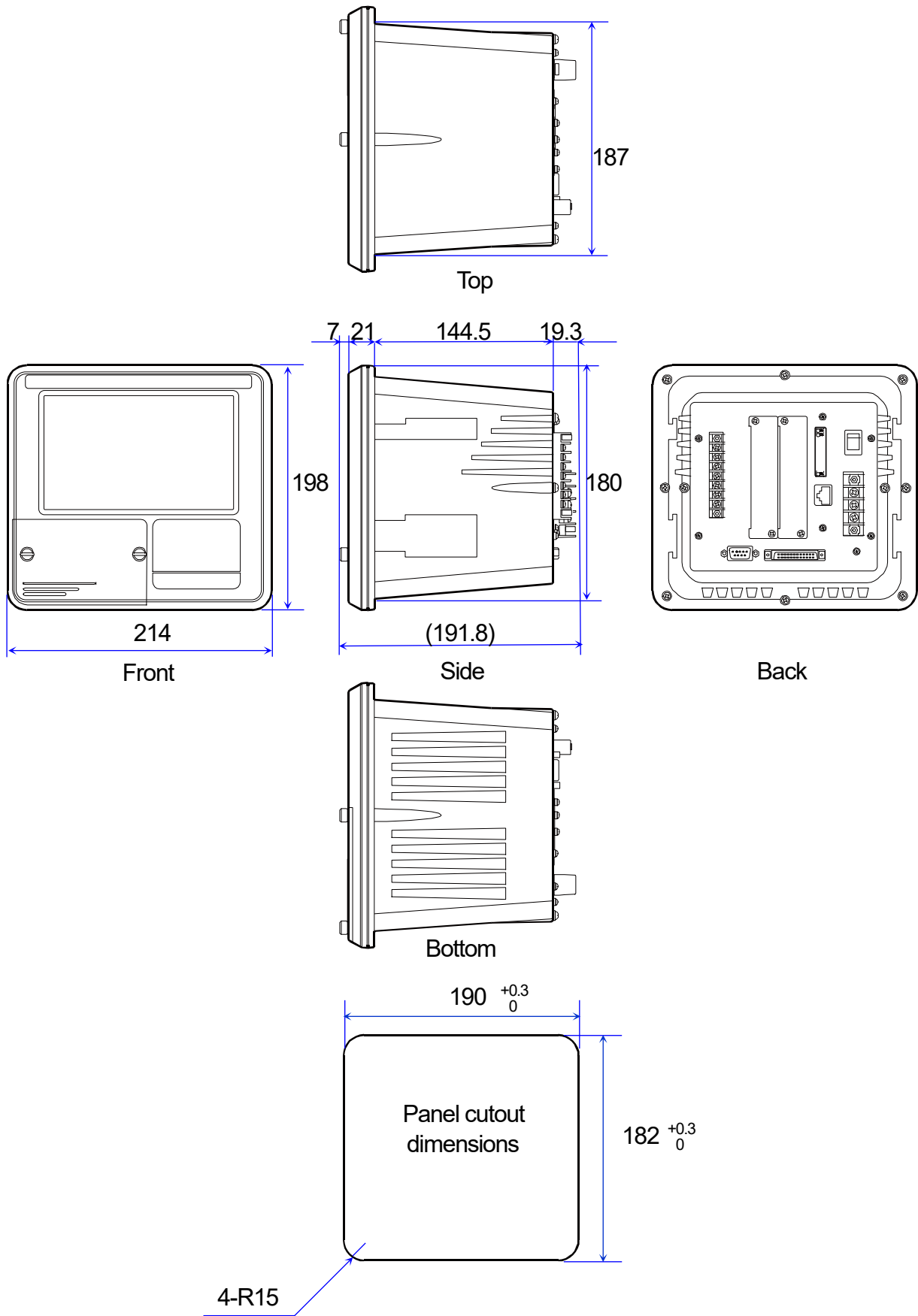



### 13.1.2. AD-4413-CW

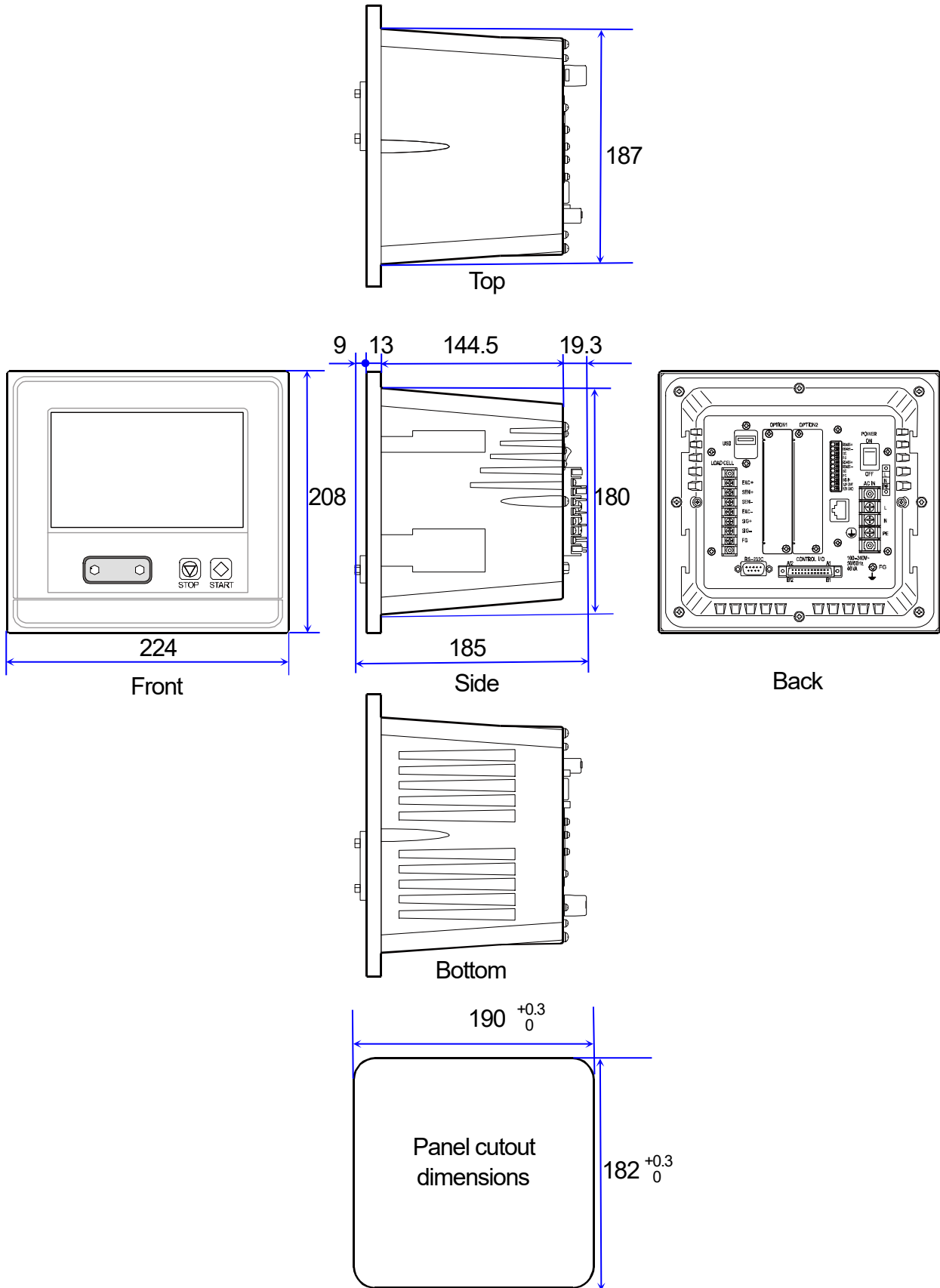







### **A&D Company, Limited**

3-23-14 Higashi-Ikebukuro, Toshima-ku, Tokyo 170-0013, JAPAN  
Telephone: [81] (3) 5391-6132 Fax: [81] (3) 5391-1566

### **A&D ENGINEERING, INC.**

47747 Warm Springs Blvd, Fremont, California 94539, U.S.A.  
Tel: [1] (800) 726-3364 Weighing Support:[1] (888) 726-5931 Inspection Support:[1] (855) 332-8815

### **A&D INSTRUMENTS LIMITED**

Unit 24/26 Blacklands Way, Abingdon Business Park, Abingdon, Oxfordshire OX14 1DY United Kingdom  
Telephone: [44] (1235) 550420 Fax: [44] (1235) 550485

### **A&D AUSTRALASIA PTY LTD**

32 Dew Street, Thebarton, South Australia 5031, AUSTRALIA  
Telephone: [61] (8) 8301-8100 Fax: [61] (8) 8352-7409

### **A&D KOREA Limited**

한국에이.엔.디(주)  
서울특별시 영등포구 국제금융로6길33 (여의도동) 맨하탄빌딩 817 우편 번호 07331  
( 817, Manhattan Bldg., 33. Gukjegeumyung-ro 6-gil, Yeongdeungpo-gu, Seoul, 07331 Korea )  
전화: [82] (2) 780-4101 팩스: [82] (2) 782-4264

### **OOO A&D RUS**

### **ООО "ЭЙ энд ДИ РУС"**

Почтовый адрес:121357, Российская Федерация, г.Москва, ул. Вереysкая, дом 17  
Юридический адрес: 117545, Российская Федерация, г. Москва, ул. Дорожная, д.3, корп.6, комн. 86  
( 121357, Russian Federation, Moscow, Vereyskaya Street 17 )  
тел.: [7] (495) 937-33-44 факс: [7] (495) 937-55-66

### **A&D Instruments India Private Limited**

### **ऐ&डी इन्स्ट्रुमेंट्स इण्डिया प्रा० लिमिटेड**

D-48, उद्योग विहार , फेस -5, गुडगांव - 122016, हरियाणा , भारत  
( D-48, Udyog Vihar, Phase-V, Gurgaon - 122016, Haryana, India )  
फोन : [91] (124) 4715555 फैक्स : [91] (124) 4715599

### **A&D SCIENTECH TAIWAN LIMITED. A&D台灣分公司 艾安得股份有限公司**

台灣台北市中正區青島東路5號4樓  
( 4F No.5 Ching Tao East Road, Taipei Taiwan R.O.C. )  
Tel : [886](02) 2322-4722 Fax : [886](02) 2392-1794

### **A&D INSTRUMENTS (THAILAND) LIMITED**

### **บริษัท เอ แอนด์ ดี อินสตรูमेंท์ (ไทยแลนด์) จำกัด**

168/16 หมู่ที่ 1 ตำบลรังสิต อำเภอธัญบุรี จังหวัดปทุมธานี 12110 ประเทศไทย  
( 168/16 Moo 1, Rangsit, Thanyaburi, Pathumthani 12110 Thailand )  
Tel : [66] 20038911