

AD-4408C

Weighing Indicator





INSTRUCTION MANUAL



1WMPD4001849A

WARNING DEFINITIONS

The warnings described in this manual have the following meanings:

 WARNING	A potentially hazardous situation which, if not avoided, could result in death or serious injury.
 CAUTION	A potentially hazardous situation which, if not avoided, may result in minor or moderate injury or damage to the instrument.
	This symbol indicates caution against electrical shock. Do not touch the part where the symbol is placed.
	This symbol indicates the ground terminal.
	This symbol indicates that an operation is prohibited.
NOTE	Information or cautions to use the device correctly.

© 2012 A&D Company Ltd. All rights reserved.

No part of this publication may be reproduced, transmitted, transcribed, or translated into any language in any form by any means without the written permission of A&D Company Ltd.

The contents of this manual and the specifications of the instrument covered by this manual are subject to change for improvement without notice.



Contents

1.	Safety Precautions	3
2.	Introduction	4
3.	Specifications	5
3.1.	Analog Section	5
3.2.	Digital Section	5
3.3.	General	6
4.	Description of Each Part	8
4.1.	Front Panel	8
4.2.	Rear Panel	10
5.	Installation	12
5.1.	Precautions	12
5.2.	Load Cell Cable Type.....	13
5.3.	Shield Connection	13
5.4.	Load Cell Connection.....	14
5.5.	Checking the Load Cell Connection	15
6.	Operation.....	16
6.1.	General Function.....	16
6.2.	Mode Map	19
7.	Calibration	20
7.1.	General Description	20
7.2.	Calibration With an Actual Load ($[\text{CAL SET}]$).....	21
7.3.	Calibration-Related Functions ($[\text{CAL F}]$).....	23
7.4.	Calibration Errors	29
7.5.	Load Cell Output Adjustment	30
8.	General Functions	31
8.1.	Setting Procedure	31
8.2.	Adjusting the Digital Filter	32
8.2.	Basic Functions ($[\text{FUNC}]$)	33
8.3.	Standard Serial Output ($[\text{L F}]$)	34
8.4.	CC-Link ($[\text{L F}]$).....	34
9.	Interface.....	35
9.1.	Standard Serial Output.....	35
9.2.	CC-Link	37
10.	Maintenance	50
10.1.	Error Messages.....	50
10.2.	Check Mode.....	50
10.3.	Initialization Mode	54
10.4.	Checking the Load Cell Connection Using the Digital Multimeter	56

11. Setting List.....	58
11.1. Basic Functions.....	58
11.2. Standard Serial Output.....	59
11.3. CC-Link.....	59
11.4. Calibration-Related Functions.....	60
12. External Dimensions.....	62



1. Safety Precautions

For safe and correct usage, read the following precautions carefully before using the indicator.

Grounding

Earth ground the indicator by connecting the ground terminal located on the rear panel to the earth, to prevent a fire, electrical shock or indicator malfunction.

Do not share the ground line with other electrical power equipment.

Appropriate power cable

Use a power cable appropriate to the supply voltage and current used. Using an inappropriate cable may cause electrical leakage or a fire.

Connect the power cable to the terminals firmly using compression lugs.

Fuse replacement

A fuse is provided to protect against a fire hazard.

The indicator is equipped with various protection circuits and the fuse rarely burns out under normal operations.

If the fuse burns out, the internal circuits may have been damaged by surges. Do not try to replace the fuse. Contact the nearest A&D dealer.

Avoid water and moisture

The indicator is not water-resistant.

Securing the front panel to the control panel using the accessory panel mount packing will provide the indicator the IP-65 protection.

Avoid an environment with flammable gases.

Do not use the indicator in places where flammable gases are present.

Indicator overheat

To prevent the indicator from overheating, allow appropriate clearance between the peripheral devices.

If the ambient temperature exceeds the specified operating temperature, use a fan to cool the environment.



2. Introduction

- The AD-4408C is a weighing indicator that amplifies signals from a load cell, converts it to digital data and displays it as a mass value.
- The accessory panel mount packing will provide the indicator the IP-65 protection.
- This indicator has the following performance:
 - Input sensitivity: 0.15 $\mu\text{V}/\text{d}$
 - Display resolution: 999,999 d max.
 - Sampling rate:..... 100 times/second
 - Input voltage range: -35 mV to +35 mV (-7 mV/V to +7 mV/V)
- Digital span mode:

Keying in the load cell output voltage (mV/V) allows calibration to be performed without an actual load.
- CC-Link interface:

A CC-Link interface, provided as standard equipment, allows construction of a weighing system easily on a CC-Link network.

NOTE: The AD-4408C CC-Link is a remote device station.

By switching the number of occupied stations (for example 1, 2 or 4), up to 42 indicators can be connected to one master device when only AD-4408Cs are used.

The unit, d indicates a minimum division.



3. Specifications

3.1. Analog Section

Input sensitivity	0.15 $\mu\text{V}/\text{d}$ or greater	
Input voltage range	-35 mV to +35 mV (-7 mV/V to +7 mV/V)	
Zero adjustment range	-35 mV to +35 mV (-7 mV/V to +7 mV/V)	
Load cell excitation voltage	5VDC $\pm 5\%$, 120 mA with remote sensing capability	
Load cell drive capacity	Maximum 8 x 350 Ω load cells	
Temperature coefficient	Zero	$\pm 0.02 \mu\text{V}/^\circ\text{C}$ typ., $\pm 0.1 \mu\text{V}/^\circ\text{C}$ max.
	Span	$\pm 3\text{ppm}/^\circ\text{C}$ typ., $\pm 15\text{ppm}/^\circ\text{C}$ max.
Non-Linearity	0.005 % of full scale	
A/D conversion method	Delta-sigma method	
A/D resolution count	Approximately 16,000,000 counts	
Display resolution	999,999 d max.	
Sampling rate	100 times/second	

3.2. Digital Section

Display element	<ul style="list-style-type: none">• Measurement display: 6-digit 7-segment green LED• Character height: 14.6 mm• Polarity display: 1 green LED• Status indicator: 6 red LEDs
Measurement display	<ul style="list-style-type: none">• Switches between NET and GROSS• Selectable decimal places (10^1, 10^2, 10^3, 10^4, 10^5)• Overflow display All the digits turn OFF. (When the polarity is negative, the minus sign appears at the highest-order digit.)
Status indicators	ZERO, STABLE, GROSS, NET, HOLD, \square
Key switches	ZERO, TARE, NET/GROSS, F, ON/OFF, ENTER, CAL

3.3. General

3.3.1. Interface

Standard serial output	Output for communication with A&D peripheral devices (20 mA current loop)
CC-Link interface	CC-Link ver.1.10 remote device station

3.3.2. Measuring functions

Zero adjustment	<ul style="list-style-type: none">• Sets the gross weight to zero by pressing the ZERO key or a command from the CC-Link master station.• Selection of disable or enable for the operation when unstable.• The zero value is battery backed up.• Zero adjustable range Can be set optionally in the range of 1 to 100% of the weighing capacity.
Zero tracking	<ul style="list-style-type: none">• Tracks the weight drift around the zero point to maintain zero.• Zero tracking time 0.0 to 5.0 seconds (Can be set optionally within the range.)• Zero tracking band 0.0 to 9.9 d (Can be set optionally within the range.)
Tare	<ul style="list-style-type: none">• Sets the net weight to zero by pressing the TARE key or a command from the CC-Link master station.• Selection of disable or enable for the operation when unstable or negative.• The tare weight is battery backed up.• Tare range: Gross weight \leq Weighing capacity
Stability detection	<ul style="list-style-type: none">• Turns ON the stabilization indicator when the variables of the weight values per sampling are within the set band in the set time.• Stability can be confirmed using the CC-Link.• Stability detection time 0.0 to 9.9 seconds (Can be set optionally within the range.)• Stability detection band 0 to 9 d (Can be set optionally within the range.)
Digital filter	Cutoff frequency range: 0.07 to 11 Hz

3.3.3. Other

Data backup	<ul style="list-style-type: none">• Zero value and tare weight Memory backup by lithium battery. (Approx. 10 years)• Calibration data and function data Written into the EEPROM
Power source	100 VAC to 240 VAC, +10%, -15%, (50/60 Hz)
Power consumption	Approximately 10 VA
Operating temperature	-10°C to +40°C
Operating humidity	85% R.H. or less (no condensation)
Installation method	Panel mount
Mass	Approximately 800 g

3.3.4. Accessories

Item	Quantity	Model name
CC-Link connector	1	1TM-721-105/037A
Connector operation lever	1	1TM-231-131
Weighing capacity plate	1	108-4023453
Unit label	1	108-4023456
Panel mount packing	1	106-4004213
Terminal block cover	1	107-4005384



4. Description of Each Part

4.1. Front Panel

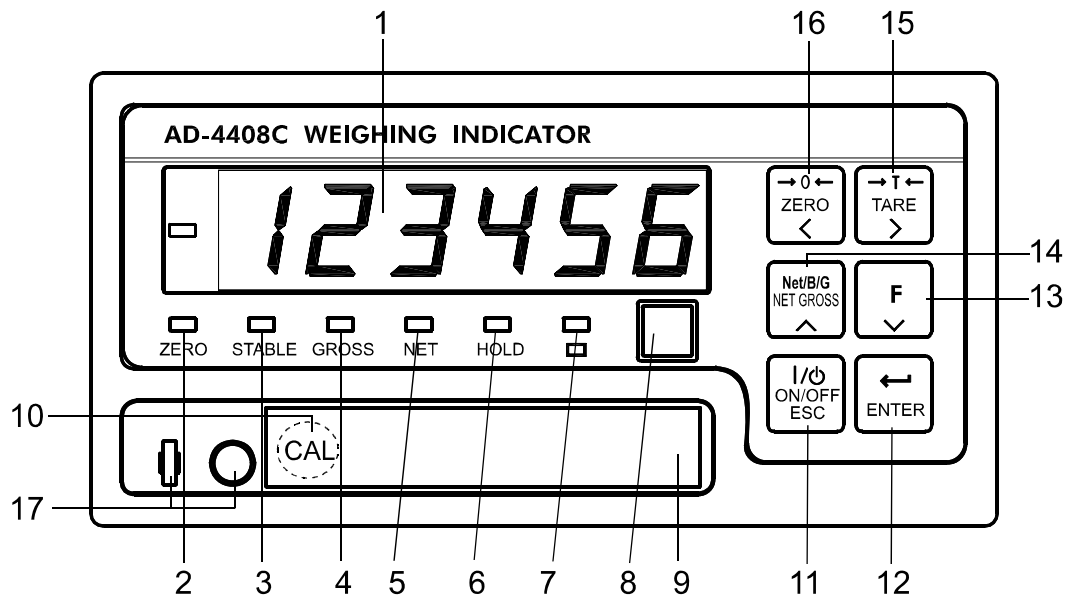









Fig.1 Front panel

Displays

No.	Name	Description
1	Main display	Displays the weight value, setting values, error messages, etc.
2	ZERO	Turns ON when the weight value is in the center of zero.
3	STABLE	<ul style="list-style-type: none"> • Turns ON when the weight value is stable. • The stability conditions can be changed in the calibration-related functions.
4	GROSS	Turns ON when the displayed value is a gross weight.
5	NET	Turns ON when the displayed value is a net weight.
6	HOLD	<ul style="list-style-type: none"> • Turns ON when the weight value is being held. • Two hold modes can be selected in the general functions, either normal hold or peak hold.
7		The function for this indicator can be selected in the general functions, depending on the purpose.
8	UNIT	<ul style="list-style-type: none"> • Place a unit label. • A unit used for weighing is set in the calibration-related functions.
9	Capacity plate	Place a weighing capacity plate.
10	CAL	<ul style="list-style-type: none"> • The key to enter the calibration mode. • The key is concealed by a sealable cover. <p>To avoid unintentional operations, keep the cover attached except when entering the calibration mode.</p>

Key switches

No.	Name	Description
11		<ul style="list-style-type: none"> • The key to turn the indicator ON (Weighing mode) and OFF (OFF mode). • To turn the indicator OFF (OFF mode), press and hold the key for three seconds or more. • When OFF, all of the displays and external output/input devices are turned OFF, but a decimal point located at the right side of the main display remains ON. • The key functions as an ESC key when the numerical values are being entered.
12		<ul style="list-style-type: none"> • The key to proceed to the selected mode. • Confirms the setting value and stores the data when pressed after a setting is changed.
13		<ul style="list-style-type: none"> • The function for this key can be selected in the general functions, from the list below: <ul style="list-style-type: none"> None Manual print command Hold Alternate switch Momentary switch Clear the tare weight Clear the zero value • The key decreases the value of the blinking digit by one when the numerical values are being entered.
14		<ul style="list-style-type: none"> • The key to switch between the gross weight and the net weight. • The key increases the value of the blinking digit by one when the numerical values are being entered.
15		<ul style="list-style-type: none"> • The key to perform tare. • The tare conditions are set in the calibration-related functions. • The key shifts the position of the blinking digit to the right when the numerical values are being entered. • In the OFF mode, pressing the ON/OFF key while holding down the TARE key will clear the zero value and the tare weight.
16		<ul style="list-style-type: none"> • The key to zero the current display. • The zero conditions are set in the calibration-related functions. • The key shifts the position of the blinking digit to the left when the numerical values are being entered.
17	Seal	<ul style="list-style-type: none"> • Can be sealed using a wire seal.

4.2. Rear Panel

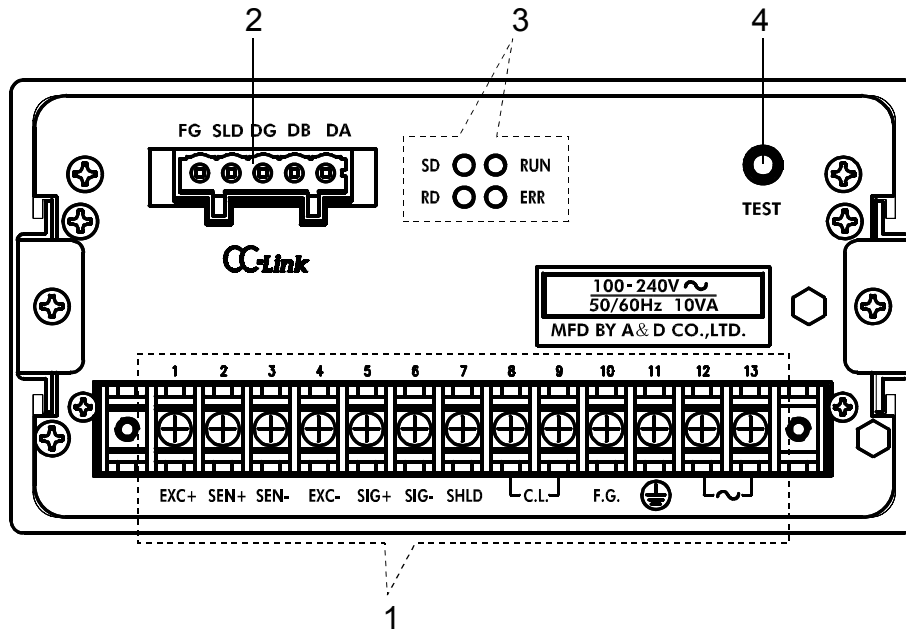

Fig.2 Rear panel

No.	Name	Description
1	Terminal block	See the detailed description below.
2	CC-Link connector	
3	CC-Link status LEDs	See the detailed description on the next page.
4	Testing terminal	Leave this terminal unconnected.

1 Terminal block

Terminal No.	Function	
1	EXC+	Load cell excitation voltage (+)
2	SEN+	Sensing input (+)
3	SEN-	Sensing input (-)
4	EXC-	Load cell excitation voltage (-)
5	SIG+	Load cell input (+)
6	SIG-	Load cell input (-)
7	SHLD	Shield
8	C.L.	Standard serial output (Current loop)
9	C.L.	Standard serial output (Current loop)
10	F.G.	Frame ground
11	⊕	Earth ground
12	~	AC power source
13	~	AC power source

NOTE: Terminals 7 (SHLD) and 11 (E) are internally connected.

To avoid unintentional operations, keep the cover attached on the terminal block.

Screw size: M3, tightening torque: 0.5N·m

3 CC-Link status LEDs

LED	ON	OFF	Blinking
RUN	Normal	<ul style="list-style-type: none"> • Resetting • No signal 	_____
SD	Transmitting	_____	_____
RD	Receiving	_____	_____
ERR	<ul style="list-style-type: none"> • Setting error • CRC error • Station trouble 	Normal	When a setting value is changed.



5. Installation

⚠ CAUTION

The weighing indicator is a precision electronic instrument. Handle it carefully.

5.1. Precautions

5.1.1. Environment

- The operating temperature is -10°C to $+40^{\circ}\text{C}$.
- Do not install the indicator in direct sunlight.
- The indicator is not water-resistant. When used in an environment where the indicator may be exposed to splashing water, secure the front panel to the control panel using the accessory panel mount packing. It makes the front panel water-resistant equivalent to IP-65.

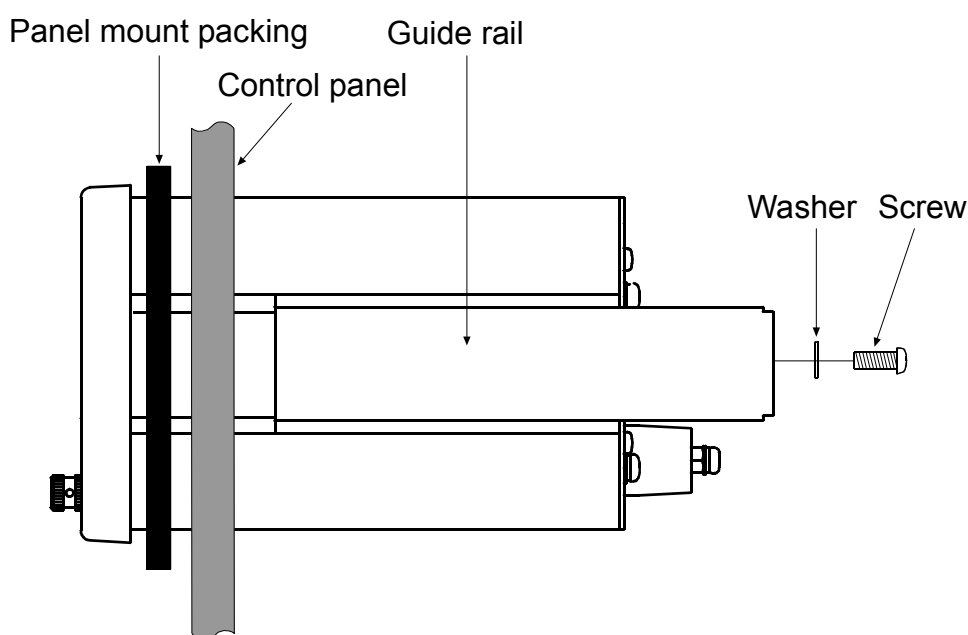

Fig.3 Panel mounting method

5.1.2. Power source



Earth ground the indicator to prevent electrical shock or indicator malfunction.

- Before connecting the indicator to the power source, read the instruction manual thoroughly.
- Do not connect the indicator to the power source before the installation is complete.
- ⚠ □ To avoid electrical shock, do not handle the power cable with a wet hand.
- ⚠ □ Earth ground the indicator. Do not share the ground line with other electrical power equipment.
- The power requirement is 100 VAC to 240 VAC and the frequency is 50 Hz or 60 Hz. Use a stable power source free from instantaneous power failure or noise.
- To avoid a malfunction, do not share the power line with other devices.
- The output voltage of a load cell is a very sensitive signal. Keep all electrical noise sources away from the load cell and load cell cable.
- Use shielded I/O cables. Connect the cable shield to the F.G. terminal or the indicator housing.

5.2. Load Cell Cable Type

Load cell cables should have high insulation and shielding performance.

Use shielded cables with the insulator that is made of materials with high insulation resistance such as Teflon[®] and polyethylene.

NOTE: Teflon is a registered trademark of DuPont.

5.3. Shield Connection

Connect the load cell shield wire only to the shield terminal (terminal 7 of the terminal block located on the rear panel) of the AD-4408C.

No ground is connected between the load cell and the AD-4408C. This is to prevent the ground loop generated by multiple ground points. Ground loop can be a major cause of noise and interference.

5.4. Load Cell Connection

Two types of load cell connection are available: 6-wire connection and 4-wire connection.

For high precision and stable weighing, 6-wire connection is recommended.

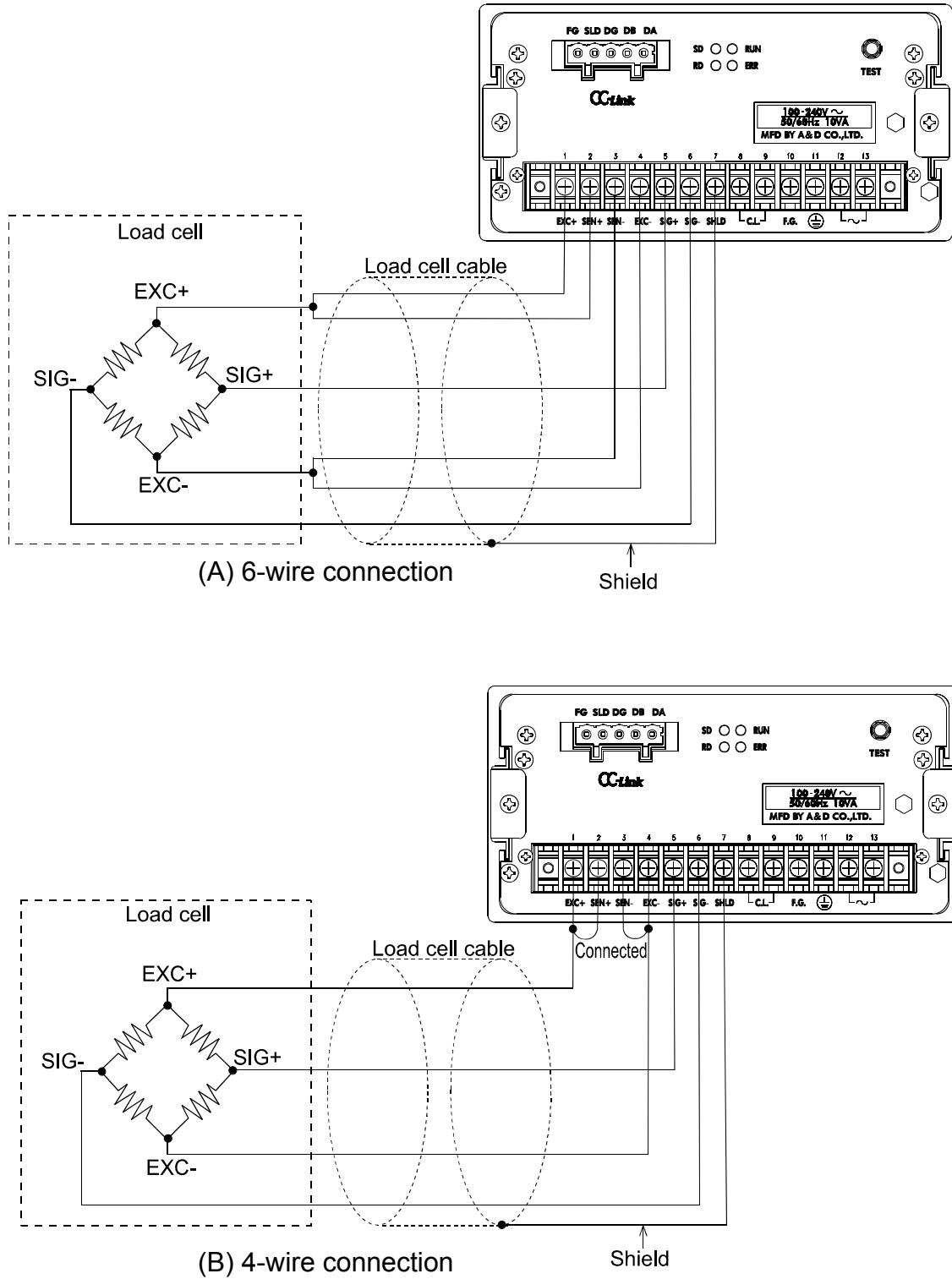

Fig.4 Load cell connection

Type	Advantages	Disadvantages	Description
6-wire connection (recommended)	The error is small even when the load cell cable is extended, a thin load cell cable is used, or multiple load cells are used.	Complicated wiring	Use a 6-wire shielded cable when a summing box is used.
4-wire connection	Simple wiring	The influence of the load cell cable resistance worsens the temperature coefficient. Prone to the influence of the contact resistance of the connector	The error increases when the load cell cable is extended or multiple load cells are used.

Precautions on performing the 4-wire connection

- Be sure to connect terminals 1 and 2 (EXC+ and SEN+) and terminals 3 and 4 (SEN- and EXC-).
- If the cable needs extending, use a cable with as large a cross-sectional area as possible or keep the cable as short as possible.

5.5. Checking the Load Cell Connection

When the load cell connection is complete, follow the procedure below to check the connection.

Step 1 Perform a visual check to ensure that the wiring is correct.

Step 2 Turn the AD-4408C ON.

All the digits may be OFF before calibration. Even under such a condition, the check mode can be used.

Step 3 Enter the check mode and check the load cell output value.

Refer to “10.2.1. Entering the check mode” to enter the A/D check mode.

Step 4 Confirm that the displayed load cell output value matches the specified value.

Normally the displayed value will be the load cell rated output value or less.

Step 5 If an error occurs, refer to “10.4. Checking the Load Cell Connection Using the Digital Multimeter” to check the connection.



6. Operation

6.1. General Function

6.1.1. Zero adjustment

- Zero adjustment is a function to set the gross weight to zero. It is performed by pressing the ZERO key or by a command from the CC-Link master station.
- The zero adjustment range is set in *CALF05* (zero adjustment range) and is expressed in percent of the weighing capacity with the calibration zero point as the center.
- Zero adjustment is disabled, even within the zero adjustment range, when the A/D converter overflow occurs.
- A ZERO error is output if zero adjustment is not performed.
- The zero value is stored in the battery backup RAM and is maintained, even if the power is disconnected.
- Clearing the zero value is performed using the F key assigned to clear the zero value. Alternately, apply power to the indicator while holding down the TARE key, or with the indicator in the OFF mode, press and hold the TARE key and press the ON/OFF key, to clear the zero value.

Functions related to zero adjustment

- *CALF05*: Changes the zero adjustment range. (0 to 100%)
- *CALF10*: Enables or disables zero adjustment when unstable.
- *CALF16*: Enables or disables power-ON zero (function to zero upon power-ON).

6.1.2. Zero tracking

- Zero tracking is a function to track the weight drift around the zero point to maintain zero.
- The zero tracking time is set in *CALF06* (zero tracking time) and the zero tracking band is set in *CALF07* (zero tracking band). When the weight drift is within the specified ranges, zero tracking is performed automatically.
- A ZERO error is not output even if zero tracking is not performed.

Functions related to zero tracking

- *CALF06*: Changes the zero tracking time. (0.0 to 5.0 seconds)
- *CALF07*: Changes the zero tracking band. (0.0 to 9.9 d)

6.1.3. Tare

- Tare is a function to store the gross weight as the tare value and set the net weight to zero.
- The tare weight is stored in the battery backup RAM and is maintained, even if the power is disconnected.
- Clearing the tare weight is performed using the F key assigned to clear the tare weight. Alternately, apply power to the indicator while holding down the TARE key, or with the indicator in the OFF mode, press and hold the TARE key and press the ON/OFF key, to clear the tare weight.

Functions related to tare

- *[ALF 10]*: Enables or disables tare when unstable.
- *[ALF 11]*: Enables or disables tare when the gross weight is negative.

6.1.4. F key

- Assign a function to the F key in the general functions.

Functions related to the F key

- *Fnc F02*: Assigns a function to the F key from the functions below:

0: None

1: Manual print command

2: Hold

3: Alternate switch (Read the description below.)

4: Momentary switch (Read the description below.)

5: Clear the tare weight

6: Clear the zero value

- *[ALF 15]*: Enables or disables clearing the zero value.

- *[ALF 20]*: Enables or disables the print command when the gross weight is negative.

Alternate switch and momentary switch

- By assigning these switches to the F key, the ON/OFF status of the F key can be transmitted to the CC-Link master station. This is useful when building a CC-Link network or performing maintenance.

- In the case that the station number is 1 and the number of occupied stations is 4, the ON/OFF status is transmitted to RX006F of the address map (In sync with display) . (ON: 1, OFF: 0)

- These switches perform as below:

Alternate switch

Press the switch once and release the switch to turn ON or OFF.

Press the switch again to turn OFF or ON.

Momentary switch

Only when the switch is being pressed, the F key is ON. When released, OFF.

6.1.5. □ display

- Assign a function to the □ display in the general functions.

Functions related to the □ display

● *FncF04*: Assigns a function to the □ display from the functions below:

0: None

1: Zero tracking in progress

2: Alarm (Zero range setting error, over, low battery)

3: F key status (Read the description below.)

F key status

● Enables when alternate switch or momentary switch is selected for *FncF02*.

The display turns ON when the F key is ON and turns OFF when the F key is OFF.

6.1.6. Memory backup

- The indicator has two kinds of memory.

EEPROM Memory used to store important data, without power supplied, that the occurrence of re-writing is seldom.
Data example: Calibration data, Function data

Battery backup RAM Memory used to store temporary data that the occurrence of re-writing is often.
Data example: Zero value, Tare weight

Memory backup

Data	Method	Description
Calibration data Function data	EEPROM	Maintained regardless of battery condition.
Zero value Tare weight	Battery backup RAM	The life of the battery is approximately 10 years at 25°C with the power disconnected.

6.2. Mode Map

The indicator has several modes to perform various operations.

Perform mode switching by key operation as shown below, only in the direction of the solid arrow.

After setting a mode, the indicator resets automatically. Alternately, the indicator resets, when the power is disconnected.

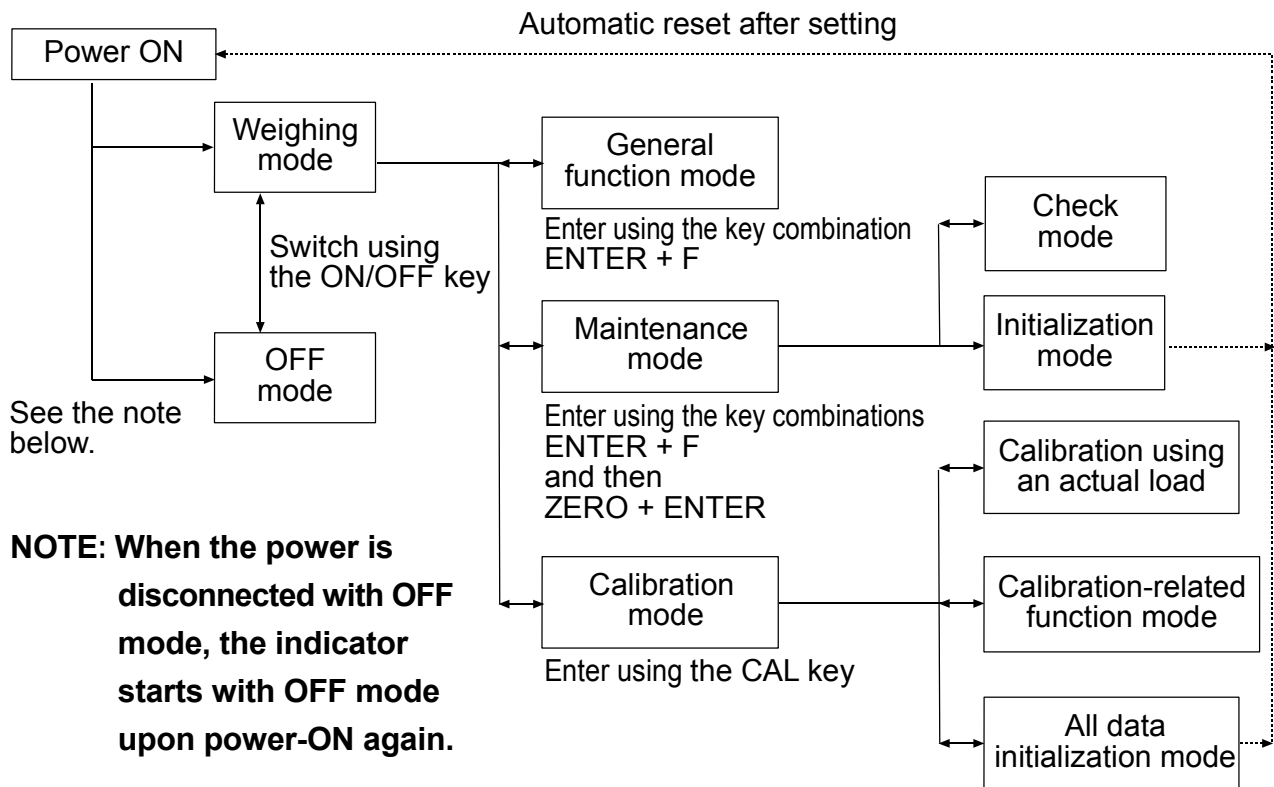

Fig.5 Mode map



7. Calibration

7.1. General Description

In the calibration mode, the operation to relate the output voltage from a load cell to the mass value and other operations directly related to weighing are performed.

Calibration with an actual load	<p>Calibration is performed using a calibration weight.</p> <ul style="list-style-type: none">• Zero calibration: Adjusts the indicator so that the measured value will be zero when no load is applied to the load cell.• Span calibration: Enter the calibration weight value and place the calibration weight on the load cell. <p>When the indicator enters the mode of calibration with an actual load, the tare weight and the zero value will be automatically cleared.</p>
Calibration-related function	<p>Setting basic constant values of the indicator such as the minimum division and weighing capacity and other data directly related to weighing is performed.</p> <p>Setting the parameters for digital span calibration is also performed.</p>
Digital span	<p>Calibration is performed without an actual load, by keying in the load cell output voltage (mV/V).</p> <ul style="list-style-type: none">• Input voltage at zero: Key in the load cell output at zero.• Input voltage at span: Key in the load cell output at span. (Load cell output at full capacity – load cell output at zero)• Calibration weight value at span: Key in the calibration weight value corresponding to the input voltage at span. (The input voltage at span is related to the mass value.)
All data initialization	<p>Clears all the data in the EEPROM and battery backup RAM.</p>

NOTE: All the data set in the calibration mode is stored in the EEPROM and is maintained regardless of battery condition.

7.2. Calibration With an Actual Load (CAL SET)

Calibration is performed using a calibration weight

Before performing calibration for the first time, set the unit, decimal point position, minimum division and weighing capacity in the calibration-related function mode.

NOTE: To avoid drift caused by changes in temperature, warm up the indicator for ten minutes or more before performing calibration with an actual load.

Step 1 Press the ON/OFF key to turn the indicator ON (weighing mode) if it is in the OFF mode.

Remove the CAL key cover and press the CAL key.

CAL is displayed to indicate that the indicator enters the calibration mode.

Step 2 Press the ENTER key to display CAL SET. The indicator enters the mode of calibration with an actual load. To return to the weighing mode, press the ESC key.

Zero calibration

Step 3 Press the ENTER key to display CAL 0.

If zero calibration is not to be performed, press the F key and go to step 5.

To monitor the current weight value, press the CAL key. Press the CAL key again to display CAL 0.

Step 4 With nothing placed on the load cell, wait for the stabilization indicator to turn ON and press the ENTER key. ----- is displayed for approximately two seconds.

Span calibration

Step 5 Press the ENTER key when CAL SPn is displayed.

The calibration weight value (the weighing capacity currently set) is displayed and the least digit of the value blinks.

← → ▲ ▼ keys: Press to correct the value to the value of the calibration weight used.

CAL key : Press to monitor the current value (the gross weight) and press again to display the calibration weight value.

ESC key : Press three times to return to the weighing mode without performing span calibration.

Step 6 Place a calibration weight on the load cell. Wait for the stabilization indicator to turn ON and press the ENTER key. ----- is displayed for approximately two seconds.

Step 7 CAL End is displayed. To re-adjust the span, press the F key.

Step 8 Press the ESC key. `[CALSET]` is displayed and the calibration data is written into the EEPROM.

The current state is the same as that of step 2. To return to the weighing mode, press the ESC key again.

NOTE: If `[ErrX]` is displayed, an error has occurred. Refer to “7.4. Calibration Errors” to take some measures.

If the decimal point blinks, it indicates that the current value is not the weight value.

7.3. Calibration-Related Functions (CALF)

Step 1 Press the ON/OFF key to turn the indicator ON (weighing mode) if it is in the OFF mode.

Remove the CAL key cover and press the CAL key.

CAL is displayed to indicate that the indicator enters the calibration mode.

Step 2 Press the ENTER key to display CALSET. The indicator enters the mode of calibration with an actual load. To return to the weighing mode, press the ESC key.

Step 3 Press the ▲ or ▼ key to select CALF and press the ENTER key.

Step 4 Press the ▲ or ▼ key to select a function number to be used and press the ENTER key. The current setting value is displayed.

Step 5 Change the value as necessary. Two methods to change are available, depending on the function number as below

Method	Description
Selecting a parameter	Only the available parameter is displayed and blinks. Press the ▲ or ▼ key to select a parameter.
Inputting the value	All the digits are displayed and a digit to be changed blinks. Press the ◀ or ▶ key to select a digit and press the ▲ or ▼ key to change the value.

After setting, press the ENTER key. The next function number is displayed.

When the value is not to be changed, press the ESC key to return to the function number display.

Step 6 Press the ESC key. CALSET is displayed and the data of the calibration-related functions is written into the EEPROM.

The current state is the same as that of step 2. To return to the weighing mode, press the ESC key again.

NOTE: If a value exceeding the settable range is entered, Err dt is displayed and the input is canceled.

If the decimal point blinks, it indicates that the current value is not the weight value.

Function No. Parameter or Setting range	Function	Description	Default value
<i>CALF01</i> 0 to 3	Unit	Unit of the weight value 0: None 1: g 2: kg 3: t 4: lb (USA version)	2
<i>CALF02</i> 0 to 5	Decimal point position	Decimal point position of the weight value 0: None 123456 1: 10 ¹ 12345.6 2: 10 ² 1234.56 3: 10 ³ 123.456 4: 10 ⁴ 12.3456 5: 10 ⁵ 1.23456	0
<i>CALF03</i> 1 to 6	Minimum division	Minimum division (d) of the weight value 1: 1 2: 2 3: 5 4: 10 5: 20 6: 50	1
<i>CALF04</i> 1 to 999999	Weighing capacity	Weighing capacity of the weighing instrument Weighing is possible up to the value of this setting plus 8 d. If the value exceeds this, overflow will occur and will not be displayed. The decimal point position is the same as the setting of <i>CALF02</i> .	20000
<i>CALF05</i> 0 to 100	Zero adjustment range	Range to enable zero adjustment by the ZERO key or a command from the CC-Link master station. Expressed in percent of the weighing capacity with the calibration zero point as the center, when performing power-ON zero, with the initial zero point as the center. For example, if this is set to 2, the value in the range of ±2% of the weighing capacity with the calibration zero point at the center will set to zero.	2

Function No. Parameter or Setting range	Function	Description	Default value
<i>CALF06</i> 0.0 to 5.0	Zero tracking time	Performs zero tracking using this setting in combination with the setting of the zero tracking band. When 0.0, zero tracking will not be performed. Unit: second in 0.1 increments	0.0
<i>CALF07</i> 0.0 to 9.9	Zero tracking band	Performs zero tracking using this setting in combination with the setting of the zero tracking time. When 0.0, zero tracking will not be performed. Unit: d (minimum division) in 0.1 increments	0.0

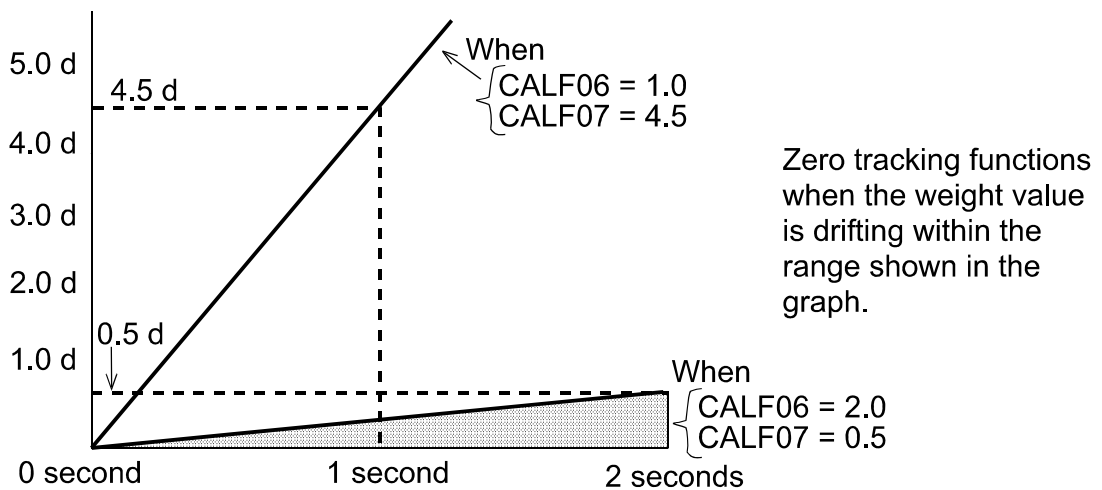
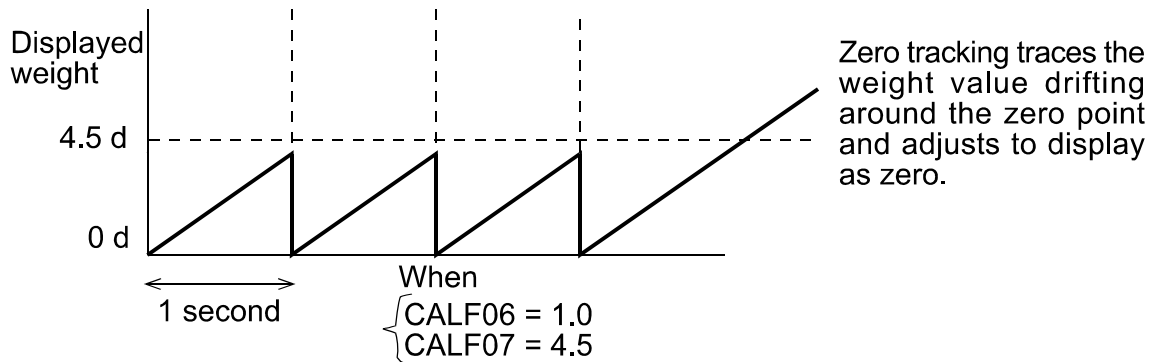

Function No. Parameter or Setting range	Function	Description	Default value
<i>CALF08</i> 00 to 99	Stability detection time	Performs stability detection using this setting in combination with the setting of the stability detection band. When 0.0, stability detection will not be performed. (Stable all the time) Unit: second in 0.1 increments	10
<i>CALF09</i> 0 to 9	Stability detection band	Performs stability detection using this setting in combination with the setting of the stability detection time. When 0, stability detection will not be performed. (Stable all the time) Unit: d (minimum division)	2

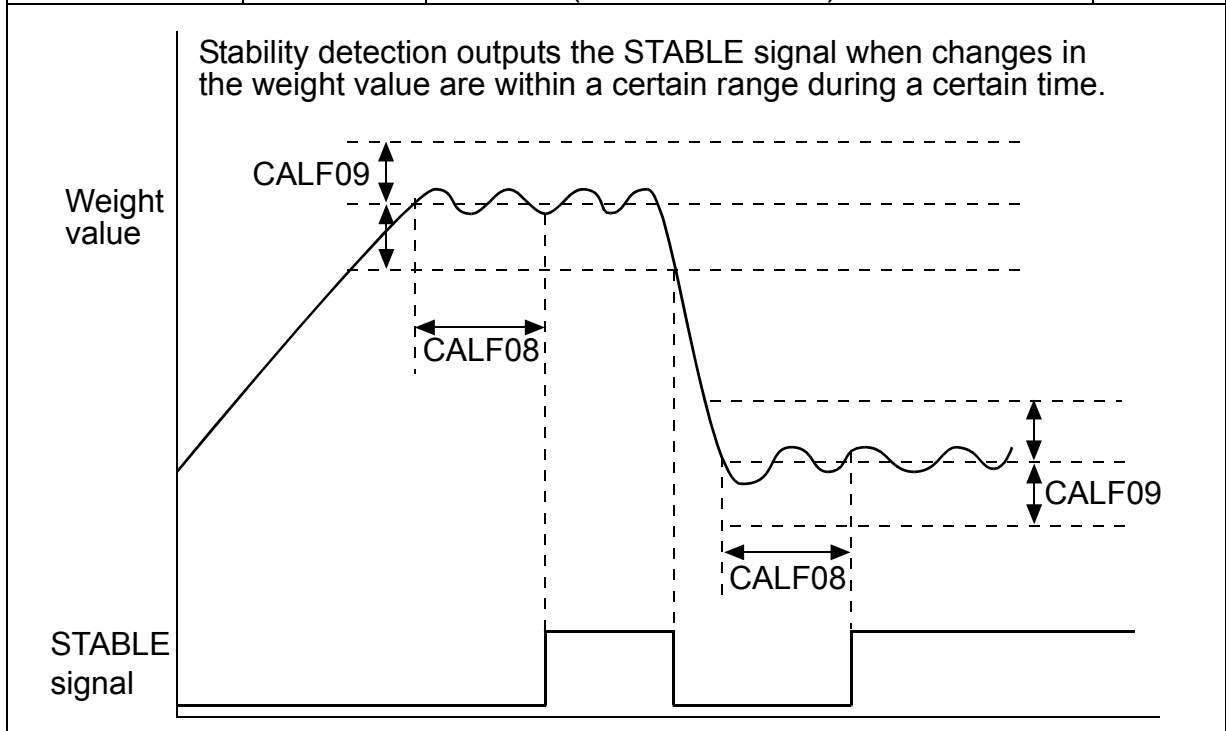

<i>CALF10</i> 0 to 1	Tare and zero adjustment when unstable	Tare and zero adjustment when the weight value is unstable. 0: Disables both functions. 1: Enables both functions.	1
<i>CALF11</i> 0 to 1	Tare when the gross weight is negative	Tare when the gross weight is negative. 0: Disables tare. 1: Enables tare.	1
<i>CALF12</i> 0 to 1	Output when overflow and unstable	Standard serial output if the weight value overflows and is unstable. 0: Disables output. 1: Enables output.	1

Function No. Parameter or Setting range	Function	Description	Default value
<i>CALF 13</i> <i>1 to 3</i>	Over at negative gross weight	Condition to judge over when the gross weight is negative. A/D negative over or <i>1</i> : Gross weight < -999999 <i>2</i> : Gross weight < negative weighing capacity <i>3</i> : Gross weight < -19 d	<i>1</i>
<i>CALF 14</i> <i>1 to 2</i>	Over at negative net weight	Condition to judge over when the net weight is negative. Gross weight negative over or <i>1</i> : Net weight < -999999 <i>2</i> : Net weight < negative weighing capacity	<i>1</i>
<i>CALF 15</i> <i>0 to 1</i>	Clear the zero value	Select whether or not to clear the zero value. <i>0</i> : Disables. <i>1</i> : Enables.	<i>1</i>
<i>CALF 16</i> <i>0 to 1</i>	Zero upon power-ON	Select whether or not to perform zero upon power-ON. <i>0</i> : Disables. <i>1</i> : Enables.	<i>0</i>
<i>CALF 17</i> <i>-700000 to</i> <i>700000</i>	Input voltage at zero	Input voltage from a load cell at zero. Unit: mV/V In zero calibration during the calibration with an actual load, this value is determined.	<i>0.000000</i>
<i>CALF 18</i> <i>000000 1 to</i> <i>999999</i>	Input voltage at span	Input voltage from a load cell at span Unit: mV/V In span calibration during the calibration with an actual load, this value and the value of <i>CALF 19</i> are determined.	<i>2.000000</i>
<i>CALF 19</i> <i>1 to 999999</i>	Calibration weight value corresponding to Input voltage at span	The calibration weight value corresponding to the Input voltage at span of <i>CALF 18</i> . When performing digital span, <i>CALF 17</i> , <i>18</i> and <i>19</i> are required. The decimal point position is the same as the setting of <i>CALF02</i> .	<i>20000</i>

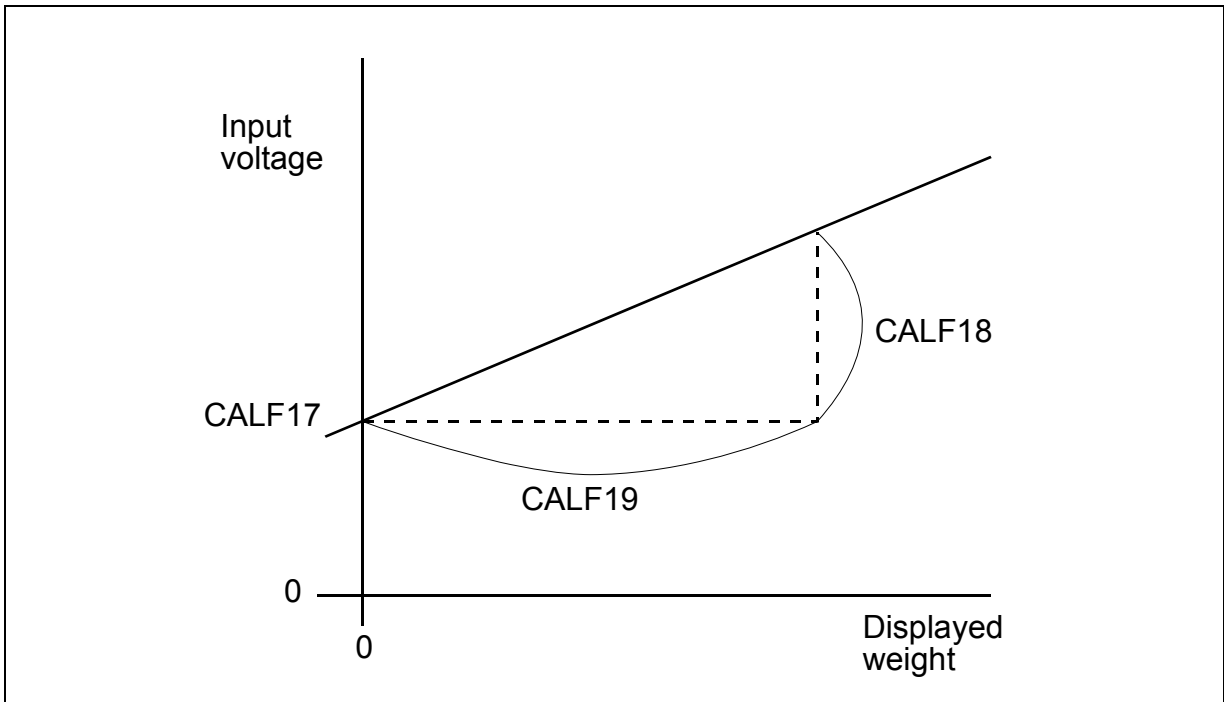

NOTE: Record the setting values of *CALF 17, 18* and *19* in the “Setting List” at the end of the manual to prepare against a failure.

By changing the parameters of *CALF 17, 18* and *19*, “zero calibration” and “span calibration” can be adjusted optionally. (Digital span accuracy approx. 1/5000: The accuracy varies depending on the load cell output accuracy and the conditions of calibration.)

Except for an emergency, perform calibration with an actual load.

<i>CALF20</i> 0 to 1	Output when the gross weight is negative	Output by the manual print command when the gross weight is negative. 0: Enables output. 1: Disables output.	0
<i>CALF21</i> 0 to 1	Communication restriction	Restriction on network-related communication such as changing station numbers or ID numbers and outputting by auto printing 0: Disables restriction. 1: Enables restriction.	0
<i>CALF22</i> 1 to 2	Header 2	Second header for serial output 1: GS / NT / TR 2: G_ / N_ / T_ (_ space)	1

7.4. Calibration Errors

When an error occurs during calibration, the error number is displayed.

If calibration is finished without releasing the error, the setting values will be restored to the state before calibration.

Calibration errors and remedies

Error No.	Description	Remedy
[Err 1	The display resolution (weighing capacity / minimum division) exceeds the specified value.	Make the minimum division greater or make the weighing capacity smaller. The specified value depends on the instrument or specifications.
[Err 2	Voltage at zero calibration exceeds in the positive direction.	Check the load cell rating and connection. When nothing is wrong with the rating and connection, adjust the load cell output as described in the next section.
[Err 3	Voltage at zero calibration exceeds in the negative direction.	When the load cell or A/D converter may be the cause of error, confirm it by using the check mode.
[Err 4	The value of the calibration weight exceeds the weighing capacity.	Use an appropriate calibration weight and calibrate again.
[Err 5	The value of the calibration weight is less than the minimum division.	
[Err 6	The load cell sensitivity is not sufficient.	Use a load cell with higher sensitivity or make the minimum division greater.
[Err 8	The load cell output voltage is too high when the load of the weighing capacity is placed.	Use a load cell with a greater rating or make the weighing capacity smaller.
[Err 7	Voltage at span calibration is less than voltage at the zero point.	Check the load cell connection.

7.5. Load Cell Output Adjustment

Add a resistor as shown below to adjust the load cell output.

Use a resistor with a high resistance value and a low temperature coefficient.

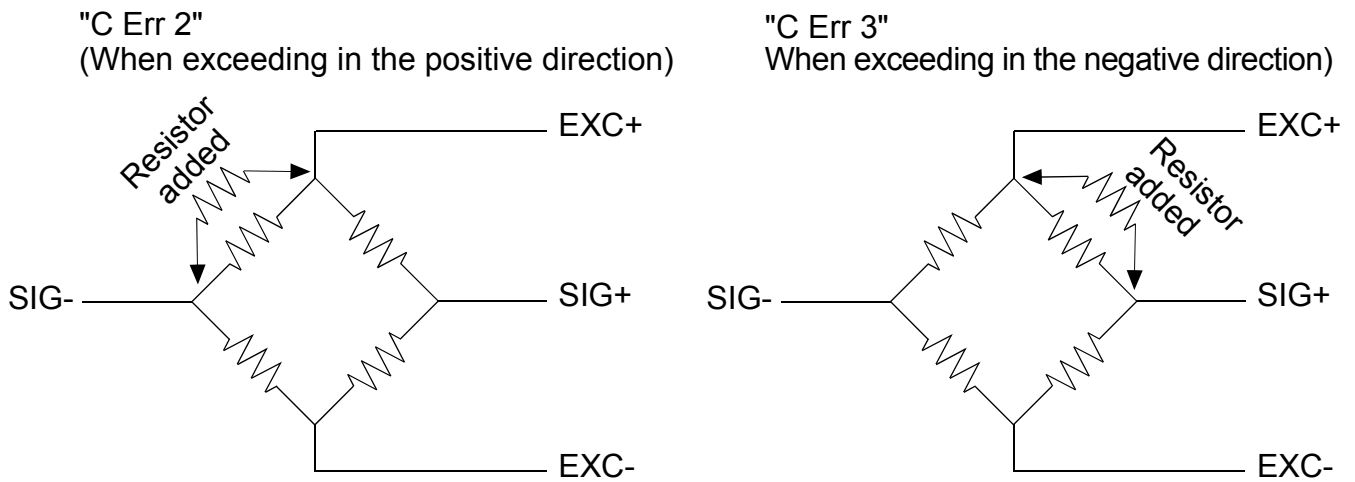

Fig.6 Load cell output adjustment

NOTE: As the zero adjustment range of the AD-4408C is wide, output adjustment is rarely required for the normal load cell.

Before adjusting the load cell output, check the load cell (deformation, clearance around the load cell, incorrect wiring and load cell type) and load cell connection.



8. General Functions

General functions are divided into groups per function and are indicated by the group name with the function number.

NOTE: General functions determine the AD-4408C performance and all the data are stored in the EEPROM.

8.1. Setting Procedure

Step 1 While holding down the ENTER key, press the F key.

\boxed{FnC} is displayed to indicate that the indicator will enter the general function mode.

Step 2 Press the ENTER key. The indicator enters the general function mode.

To return to the weighing mode without entering the general function mode, press the ESC key.

Step 3 Press the $\boxed{\wedge}$ or $\boxed{\vee}$ key to select the function group to be set.

Display	Group name
$F_{nC}F$	Basic function
$\boxed{L} F$	Standard serial output
$\boxed{L} \boxed{L} F$	CC-Link

Press the ENTER key. The function number will be displayed.

Step 4 Press the $\boxed{\wedge}$ or $\boxed{\vee}$ key to select the function number to be set.

Press the ENTER key. The current setting value will be displayed.

Step 5 Change the setting value using either one of the methods below.

Method	Description
Selecting a parameter	Only the available parameter is displayed and blinks. Press the $\boxed{\wedge}$ or $\boxed{\vee}$ key to select a parameter.
Inputting the value	All the digits are displayed and a digit to be changed blinks. Press the $\boxed{\leftarrow}$ or $\boxed{\rightarrow}$ key to select a digit and press the $\boxed{\wedge}$ or $\boxed{\vee}$ key to change the value.

After setting, press the ENTER key. The next function number is displayed.

When the parameter is not to be changed, press the ESC key to return to the function number display.

Step 6 Press the ESC key. The function number disappears and the indicator returns to the state of step 2.

Press the ESC key to store the setting values in the EEPROM and return to the weighing mode.

NOTE: If a value exceeding the settable range is entered, $\boxed{Err dt}$ is displayed and the input is canceled.

If the decimal point blinks, it indicates that the current value is not the weight value.

8.2. Adjusting the Digital Filter

Adjust the digital filter using $F_{NC}F05$ (Digital filter) and $F_{NC}F06$ (Frequency divider ratio).

Method 1 While $F_{NC}F06$ is fixed to 1 (divider ratio 1), adjust $F_{NC}F05$.
Cutoff frequency: 11.0 Hz to 0.7 Hz

Method 2 If Method 1 does not work, perform as follows:
While $F_{NC}F05$ is fixed to 8 (1.0 Hz), adjust $F_{NC}F06$.
Cutoff frequency: 0.5 Hz to 0.1 Hz

$$\text{Digital filter cutoff frequency} = \frac{F_{NC}F05 \text{ cutoff frequency}}{F_{NC}F06 \text{ divider ratio}}$$

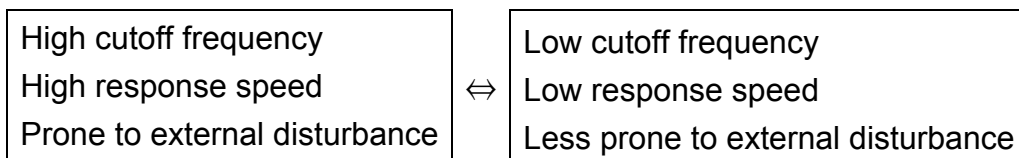

8.2. Basic Functions ($F_{nc}F$)

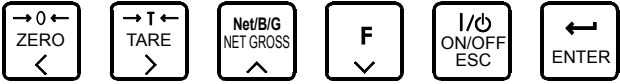
Function No. Parameter or Setting range	Function	Description	Default value
$F_{nc}F01$ 000000 to 111111	Disable key switch	Each digit of the setting corresponds to a key switch. Only available in the weighing mode. 0: Does not disable the key switch function. 1: Disables the key switch function. Key assignment 6 th 5 th 4 th 3 rd 2 nd 1 st 	000000 (binary)
$F_{nc}F02$ 0 to 6	F key	Assigns a function to the F key. 0: None 1: Manual print command 2: Hold 3: Alternate switch 4: Momentary switch 5: Clear the tare weight 6: Clear the zero value NOTE: Clearing the zero value can be enabled or disabled by $CALF15$	0
$F_{nc}F03$ 1 to 3	Display update rate	1: 20 times/second 2: 10 times/second 3: 5 times/second	1
$F_{nc}F04$ 0 to 3	□ display	Assigns a function to the □ display. 0: None 1: Zero tracking in progress 2: Alarm (Zero range setting error, over, low battery) 3: F key status	0
$F_{nc}F05$ 0 to 9	Digital filter	Selects a cutoff frequency. 0: None 1: 11.0 Hz 2: 8.0 Hz 3: 5.6 Hz 4: 4.0 Hz 5: 2.8 Hz 6: 2.0 Hz 7: 1.4 Hz 8: 1.0 Hz 9: 0.7 Hz	8
$F_{nc}F06$ 1 to 10	Frequency divider ratio	Divides digital filter cutoff frequency by the setting.	1
$F_{nc}F07$ 1 to 2	Hold	1: Normal hold 2: Peak hold	1

8.3. Standard Serial Output ([L F])

Function No. Parameter or Setting range	Function	Description	Default value
[L F01] 1 to 5	Output data	1: Displayed weight 2: Gross weight 3: Net weight 4: Tare weight 5: Gross/Net/Tare	1
[L F02] 1 to 3	Data transfer mode	1: Stream 2: Auto printing (See the NOTE below) 3: Manual printing	1
[L F03] 1 to 2	Baud rate	1: 600 bps 2: 2400 bps	2

NOTE: When “1: Enables restriction” is selected for [ALF21 (Communication restriction), auto printing will not be performed even if auto printing conditions are met.

8.4. CC-Link ([C F])

Function No. Parameter or Setting range	Function	Description	Default value
[C F01] 1 to 64	Station number	n: Station number	1
[C F02] 0 to 2	Occupied stations	0: One 1: Two 2: Four	2
[C F03] 0 to 4	Baud rate	0: 156 kbps 1: 625 kbps 2: 2.5 Mbps 3: 5 Mbps 4: 10 Mbps	4
[C F04] 0 to 1	Initialization	0: Not required (When the AD-4408C is turned on and the CC-Link is ready, the remote READY flag (RX007B) becomes active without performing initialization.) 1: Required (When the AD-4408C is turned on and the CC-Link is ready, the remote READY flag (RX007B) becomes active after the initialization is complete.)	1
[C F05] 0 to 2	Output data	0: Displayed weight 1: Net weight 2: Gross weight Specify what data to output when the number of occupied stations is 1 or 2.	0



9. Interface

9.1. Standard Serial Output

The standard serial output with 0 to 20 mA can be connected to a device such as an A&D printer or remote display. The interface has no power source. Therefore, the external devices to be connected must have a power source. The setting values of the standard serial output are changed in the general functions [L F01 to [L F03.

Type	0 to 20 mA current loop
Data bits	7 bits
Start bit	1 bit
Parity	1 bit, even
Stop bit	1 bit
Baud rate	600, 2400 bps
Code	ASCII

9.1.1. Connection

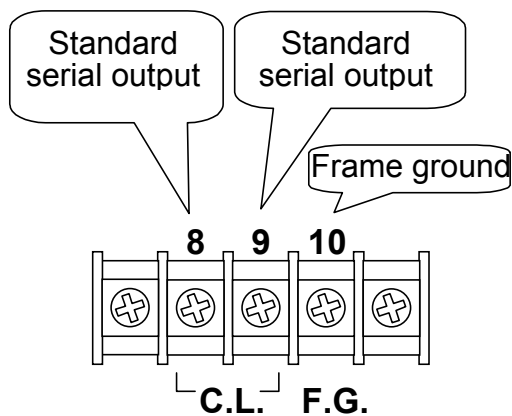

Fig.7 Standard serial output pin connection

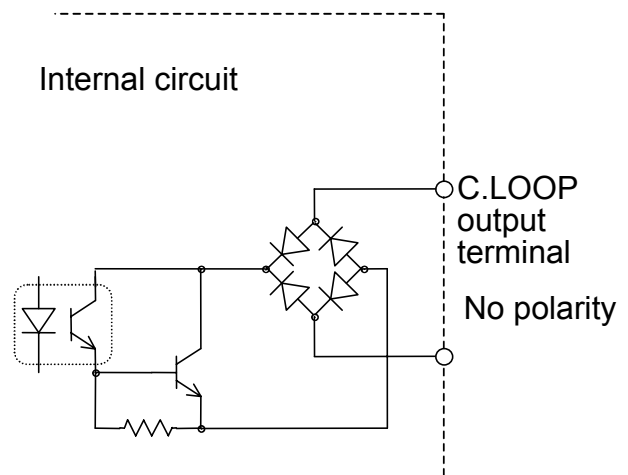

Fig.8 Standard serial output internal circuit

NOTE: The standard serial output connection has no polarity.
When a shielded cable is used, connect the shield to the F.G. terminal.

9.1.2. Output data

The data format used is A&D standard format. This is a format to be used with an A&D printer or remote display and consists of two headers, data, unit and a terminator.

A&D standard format

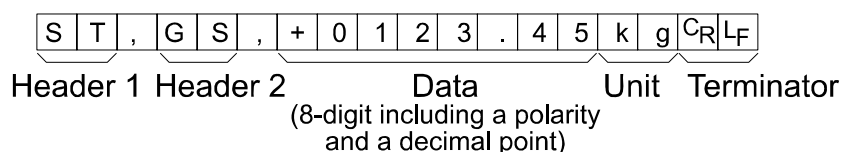

	ASCII code	Hexadecimal	Description
Header 1	ST	[53 54]	Stable
	US	[55 53]	Unstable
	OL	[4F 4C]	Overload
Header 2	GS	[47 53]	Gross weight
	NT	[4E 54]	Net weight
	TR	[54 52]	Tare weight
Separator	,	[2C]	
Data (ASCII code)	0 to 9	[30 to 39]	
	+	[2B]	
	-	[2D]	
	SP (space)	[20]	
	.	[2E]	
Unit (five types)	SP SP	[20 20]	No unit
	SP g	[20 67]	g
	kg	[6B 67]	kg
	SP t	[20 74]	t
	lb	[6C 62]	lb (USA version)

A&D standard format examples

	Header 1	Header 2	Data (8-digit including a polarity and a decimal point)	Unit	Terminator														
Gross weight	S	T	,	G	S	,	+	0	0	1	2	3	4	5	k	g	C _R	L _F	Header 2 [GS]
Net weight	S	T	,	N	T	,	+	0	0	1	0	0	0	0	k	g	C _R	L _F	Header 2 [NT]
Tare weight	S	T	,	T	R	,	+	0	0	0	2	3	4	5	k	g	C _R	L _F	Header 2 [TR]
Data with a decimal point	S	T	,	G	S	,	+	0	1	2	3	.	4	5	k	g	C _R	L _F	Data [.]
Positive overflow	O	L	,	G	S	,	+	SP	SP	SP	SP	.	SP	SP	k	g	C _R	L _F	Header 1 [OL]
Negative overflow	O	L	,	G	S	,	-	SP	SP	SP	SP	.	SP	SP	k	g	C _R	L _F	Header 1 [OL] Polarity [-]
Unstable data	U	S	,	G	S	,	+	0	1	2	3	.	4	5	k	g	C _R	L _F	Header 1 [US]
“Output OFF” data	O	L	,	G	S	,	+	SP	SP	SP	SP	.	SP	SP	k	g	C _R	L _F	Same as positive overflow

NOTE: The decimal point position is the same even when overflow occurs.

9.1.3. Data transfer mode

Three data transfer modes are available; stream, auto printing and manual printing.

Stream mode	Transmits data in sync with the display update rate. If the indicator can not catch up with the update rate because of the baud rate, the transmission is paused until the next updating. The transmitted data is the same as what is being displayed. Data that is not displayed is never transmitted.
Auto printing mode	Transmits data once only when the weight value with 5 d or greater is stable. For another transmission, the weight value must fall below 5 d once.
Manual printing mode	Transmits data when the F key that is assigned to Manual print command is pressed or a command is sent from the CC-Link master station.

9.2. CC-Link

The AD-4408C CC-Link is a remote device station of CC-Link ver.1.10. When a CC-Link is used, the AD-4408C can be controlled by the PLC remote I/O or remote registers. So, the program can be simple. And connection to a PLC is simple, thus, a weighing system can be built easily. The setting values of CC-Link are changed in the general functions `[[F01` to `[[F04`.

Station number	1 to 64
Number of occupied stations	1 station, 2 stations, 4 stations
Baud rate	156 kbps, 625 kbps, 2.5 Mbps, 5 Mbps, 10 Mbps
Initialization	Not required or required

Communications connector

The connector used can be attached or removed while the power is ON.

The function of each signal line is as follows.

DA	Signal DA
DB	Signal DB
DG	Signal ground
SLD	Shield
FG	Frame ground

Status LEDs

LED	ON	OFF	Blinking
RUN	Normal	<ul style="list-style-type: none"> • Resetting • No signal 	_____
SD	Transmitting	_____	_____
RD	Receiving	_____	_____
ERR	<ul style="list-style-type: none"> • Setting error • CRC error • Station trouble 	Normal	When the setting values are changed

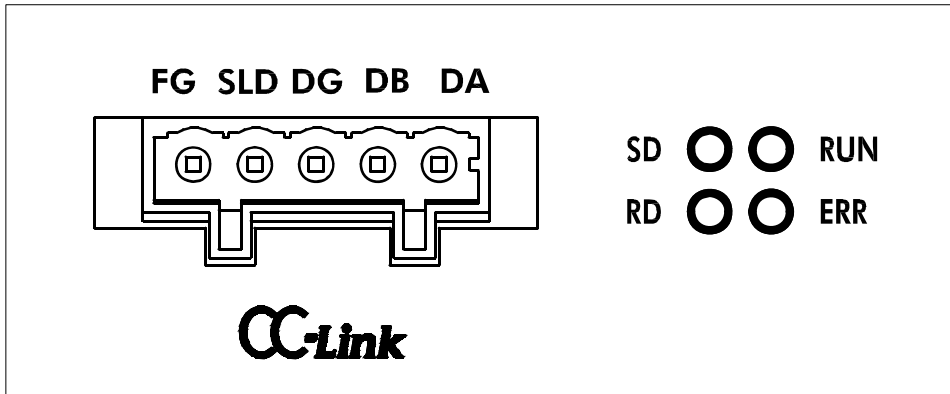

Fig.9 CC-Link connector and LEDs

9.2.1. Address map

Remote register (Number of occupied stations: 4)

Addresses are examples when the station number is set to 1.

	AD-4408C --> Master station			Master station --> AD-4408C		
Station	Remote register	Buffer memory	Name	Remote register	Buffer memory	Name
1	RWr0000	2E0	Net weight	RWw0000	1E0	Reserved internally
	RWr0001	2E1		RWw0001	1E1	
	RWr0002	2E2	Gross weight	RWw0002	1E2	
	RWr0003	2E3		RWw0003	1E3	
2	RWr0004	2E4	Reserved internally	RWw0004	1E4	
	RWr0005	2E5		RWw0005	1E5	
	RWr0006	2E6	Error code	RWw0006	1E6	
	RWr0007	2E7	Error sub-code	RWw0007	1E7	
3	RWr0008	2E8	Reserved internally	RWw0008	1E8	
	RWr0009	2E9		RWw0009	1E9	
	RWr000A	2EA		RWw000A	1EA	
	RWr000B	2EB		RWw000B	1EB	
4	RWr000C	2EC	Command data response	RWw000C	1EC	Command data
	RWr000D	2ED		RWw000D	1ED	
	RWr000E	2EE	Command No. response	RWw000E	1EE	Command No.
	RWr000F	2EF	Reserved internally	RWw000F	1EF	Reserved internally

Remote register (Number of occupied stations: 2)

Addresses are examples when the station number is set to 1.

	AD-4408C --> Master station			Master station --> AD-4408C		
Station	Remote register	Buffer memory	Name	Remote register	Buffer memory	Name
1	RWr0000	2E0	Displayed value (Net / Gross)	RWw0000	1E0	Reserved internally
	RWr0001	2E1		RWw0001	1E1	
	RWr0002	2E2	Error code	RWw0002	1E2	
	RWr0003	2E3	Error sub-code	RWw0003	1E3	
2	RWr0004	2E4	Command data response	RWw0004	1E4	Command data
	RWr0005	2E5		RWw0005	1E5	
	RWr0006	2E6	Command No. response	RWw0006	1E6	Command No.
	RWr0007	2E7	Reserved internally	RWw0007	1E7	Reserved internally

Remote register (Number of occupied stations: 1)

Addresses are examples when the station number is set to 1.

	AD-4408C --> Master station			Master station --> AD-4408C		
Station	Remote register	Buffer memory	Name	Remote register	Buffer memory	Name
1	RWr0000	2E0	Displayed value (Net / Gross)	RWw0000	1E0	Reserved internally
	RWr0001	2E1		RWw0001	1E1	
	RWr0002	2E2	Error code	RWw0002	1E2	
	RWr0003	2E3	Error sub-code	RWw0003	1E3	

Numeric values of the remote register

All the values are hexadecimal. Negative values are expressed by the two's complement.

Decimal	Hexadecimal (16 bits)	Hexadecimal (24 bits)	Hexadecimal (32 bits)
-10	FFF6	FFFFFF6	FFFFFFFF6
-1	FFFF	FFFFFFF	FFFFFFFFF
0	0000	000000	00000000
1	0001	000001	00000001
10	000A	00000A	0000000A

NOTE: Writing is prohibited in the internally reserved areas.

Writing in the remote output (RY) and the remote register (RWw) of the internally reserved areas may cause the indicator to malfunction.

Values of the remote input (RX) and the remote register (RWr) of the internally reserved areas are not fixed.

Error code

Error code	Error status flag (Indicator error)
0	No error
1	AD error (Module error)
2	EEPROM error (Writing error)
3	RAM error (Writing error)
4	Calibration error (Calibration value error)
5	Display error (Mode error)

Remote I/O (Number of occupied stations: 4)

Addresses are examples when the station number is set to 1.

	AD-4408C --> Master station			Master station --> AD-4408C		
Station	Remote input	Buffer memory	Name	Remote output	Buffer memory	Name
1	RX0000	0E0	Reserved internally	RY0000	160	Reserved internally
	RX0001			RY0001		
	RX0002		Command processing response	RY0002		Command processing request
	RX0003		Read/write response	RY0003		Read/write request
	RX0004		Reserved internally	RY0004		Reserved internally
	RX0005			RY0005		
	RX0006		CPU normal operation	RY0006		
	RX0007		Reserved internally	RY0007		
	RX0008		Decimal point position $\begin{matrix} 2^0 \\ 2^1 \\ 2^2 \end{matrix}$ 3-bit binary	RY0008		
	RX0009			RY0009		
	RX000A			RY000A		
	RX000B		Reserved internally	RY000B		
	RX000C			RY000C		
	RX000D			RY000D		
	RX000E			RY000E		
	RX000F			RY000F		
	RX0010	Reserved internally		RY0010	Zero	
	RX0011			RY0011	Clear zero	
	RX0012			RY0012	Tare	
	RX0013		RY0013	Clear tare		
	RX0014		RY0014	Hold		
	RX0015		RY0015	Net display		
	RX0016		RY0016	Gross display		
	RX0017		Stable	RY0017	Print command	
	RX0018		Reserved internally	RY0018	Reserved internally	
	RX0019		Capacity exceeded	RY0019		
	RX001A		Hold in progress	RY001A		
	RX001B		Reserved internally	RY001B		
RX001C	RY001C					
RX001D	RY001D					
RX001E	RY001E					
RX001F	Weighing failure	RY001F				
2	RX0020	0E2	Reserved internally	RX0020	162	
3	RX005F	0E5		RX005F	165	

	AD-4408C --> Master station			Master station --> AD-4408C			
Station	Remote input	Buffer memory	Name	Remote output	Buffer memory	Name	
4	RX0060	0E6	Net over	RY0060	166	Reserved internally	
	RX0061		Net under	RY0061			
	RX0062		Gross over	RY0062			
	RX0063		Gross under	RY0063			
	RX0064		A/D over	RY0064			
	RX0065		A/D under	RY0065			
	RX0066		Net in the center of zero	RY0066			
	RX0067		Gross in the center of zero	RY0067			
	RX0068		Net display	RY0068			
	RX0069		Gross display	RY0069			
	RX006A		Tare in progress	RY006A			
	RX006B		Low battery	RY006B			
	RX006C		Zero error	RY006C			
	RX006D		Tare error	RY006D			
	RX006E		Net display error	RY006E			
	RX006F		In sync with □	RY006F			
	RX0070	0E7	Reserved internally	RY0070	167	Reply flag of initialization	
	RX0071			RY0071			
	RX0072			RY0072			
	RX0073			RY0013			
	RX0074			RY0074			
	RX0075			RY0075			
	RX0076			RY0076			
	RX0077			RY0077			
	RX0078		Request flag of initialization	RY0078			Request flag of initial data setting
	RX0079		Reply flag of initial data setting	RY0079			Request flag of error reset
	RX007A		Error status flag	RY007A			Reserved internally
	RX007B		Remote READY flag	RY007B			
RX007C	Reserved internally	RY007C					
RX007D		RY007D					
RX007E		RY007E					
RX007F		RY007F					

Remote I/O (Number of occupied stations: 2)

Addresses are examples when the station number is set to 1.

	AD-4408C --> Master station			Master station --> AD-4408C			
Station	Remote input	Buffer memory	Name	Remote output	Buffer memory	Name	
1	RX0000	0E0	Reserved internally	RY0000	160	Reserved internally	
	RX0001			RY0001			
	RX0002		Command processing response	RY0002		Command processing request	
	RX0003		Read/write response	RY0003		Read/write request	
	RX0004		Reserved internally	RY0004		Reserved internally	
	RX0005			RY0005			
	RX0006		CPU normal operation	RY0006			
	RX0007		Reserved internally	RY0007			
	RX0008		Decimal point position 2^0	RY0008			
	RX0009			2^1 3-bit binary			RY0009
	RX000A			2^2			RY000A
	RX000B		Reserved internally	RY000B			
	RX000C			RY000C			
	RX000D			RY000D			
	RX000E			RY000E			
	RX000F			RY000F			
	RX0010	0E1		Reserved internally	RY0010		Zero
	RX0011				RY0011		Clear zero
	RX0012				RY0012		Tare
	RX0013		RY0013		Clear tare		
	RX0014		RY0014		Hold		
	RX0015		RY0015		Net display		
	RX0016		RY0016		Gross display		
	RX0017		Stable		RY0017	Print command	
	RX0018		Reserved internally	RY0018	Reserved internally		
	RX0019		Capacity exceeded	RY0019			
	RX001A		Hold in progress	RY001A			
	RX001B		Reserved internally	RY001B			
	RX001C			RY001C			
	RX001D			RY001D			
	RX001E			RY001E			
	RX001F		Weighing failure	RY001F			

	AD-4408C --> Master station			Master station --> AD-4408C		
Station	Remote input	Buffer memory	Name	Remote output	Buffer memory	Name
2	RX0020	0E2	Net over	RY0020	162	Reserved internally
	RX0021		Net under	RY0021		
	RX0022		Gross over	RY0022		
	RX0023		Gross under	RY0023		
	RX0024		A/D over	RY0024		
	RX0025		A/D under	RY0025		
	RX0026		Net in the center of zero	RY0026		
	RX0027		Gross in the center of zero	RY0027		
	RX0028		Net display	RY0028		
	RX0029		Gross display	RY0029		
	RX002A		Tare in progress	RY002A		
	RX002B		Low battery	RY002B		
	RX002C		Zero error	RY002C		
	RX002D		Tare error	RY002D		
	RX002E		Net error	RY002E		
	RX002F		In sync with <input type="checkbox"/>	RY002F		
	RX0030	0E3	Reserved internally	RY0030	163	Reserved internally
	RX0031			RY0031		
	RX0032			RY0032		
	RX0033			RY0033		
	RX0034			RY0034		
	RX0035			RY0035		
	RX0036			RY0036		
	RX0037			RY0037		
	RX0038	Request flag of initialization	RY0038	Reply flag of initialization		
	RX0039	Reply flag of initial data setting	RY0039	Request flag of initial data setting		
	RX003A	Error status flag	RY003A	Request flag of error reset		
	RX003B	Remote READY flag	RY003B	Reserved internally		
	RX003C	Reserved internally	RY003C			
	RX003D		RY003D			
	RX003E		RY003E			
	RX003F		RY003F			

Remote I/O (Number of occupied stations: 1)

Addresses are examples when the station number is set to 1.

	AD-4408C --> Master station			Master station --> AD-4408C			
Station	Remote input	Buffer memory	Name	Remote output	Buffer memory	Name	
1	RX0000	0E0	Reserved internally	RY0000	160	Zero	
	RX0001			RY0001		Clear zero	
	RX0002			RY0002		Tare	
	RX0003			RY0003		Clear tare	
	RX0004			RY0004		Hold	
	RX0005			RY0005		Net display	
	RX0006			RY0006		Gross display	
	RX0007		Stable	RY0007		Print command	
	RX0008		Reserved internally	RY0008		Reserved internally	
	RX0009		capacity exceeded	RY0009			
	RX000A		Hold in progress	RY000A			
	RX000B		Reserved internally	RY000B			
	RX000C			RY000C			
	RX000D			RY000D			
	RX000E			RY000E			
	RX000F		Weighing failure	RY000F			
	RX0010	0E1	Reserved internally	RY0010	161		Reserved internally
	RX0011			RY0011			
	RX0012			RY0012			
	RX0013			RY0013			
	RX0014			RY0014			
	RX0015			RY0015			
	RX0016			RY0016			
	RX0017		RY0017				
	RX0018		Request flag of initialization	RY0018		Reply flag of initialization	
	RX0019		Reply flag of initial data setting	RY0019		Request flag of initial data setting	
	RX001A		Error status flag	RY001A		Request flag of error reset	
	RX001B		Remote READY flag	RY001B		Reserved internally	
	RX001C		Reserved internally	RY001C			
	RX001D			RY001D			
RX001E	RY001E						
RX001F	RY001F						

Weighing failure

Net over	Net under
Gross over	Gross under
A/D over	A/D under
Low battery	Zero error
Tare error	Net display error

9.2.2. Commands

The write command is used to send a command to the AD-4408C from the master station. For details, refer to “Write command” in “9.2.3. Timing chart”.

Command No.	Command data	Command
0	1	Zero
0	2	Clear zero
0	3	Tare
0	4	Clear tare
0	5	Hold
0	6	Net display
0	7	Gross display
0	8	Print command

9.2.3. Timing chart

Below examples are when the station number is set to 1 and the number of occupied stations is set to 4.

When the AD-4408 is turned on

When the AD-4408C is turned on and the CC-Link is ready, the request flag of initialization (RX0078) becomes active.

The master station confirms that RX0078 is active, performs initialization and turns the reply flag of initialization (RY0078) ON.

The AD-4408C turns the request flag of initialization (RX0078) OFF and turns the remote READY flag (RX007B) ON.

Turn OFF the reply flag of initialization (RY0078) in the master station.

NOTE: When $[[F04$ of the CC-Link functions is set to 0 (Initialization not required), the remote READY flag (RX007B) becomes active without performing initialization.

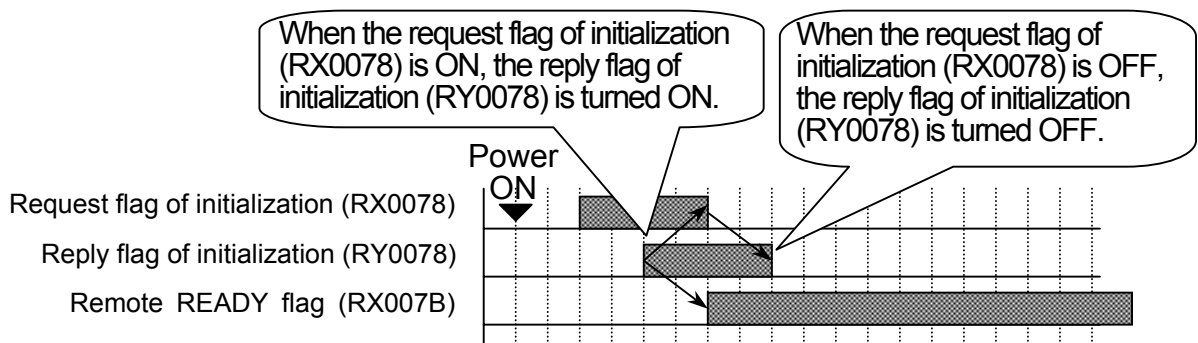

Fig.10 Performance upon power-ON

Resuming from suspended modes

When the AD-4408C is in a mode that suspends weighing, such as calibration or OFF mode, the remote READY flag (RX007B) becomes inactive because a correct weight value can not be output.

To resume from this condition, take the same steps as described in “When the AD-4408C is turned on” above.

Requesting initialization from the master station

When requesting the initial data setting to the AD-4408C from the master station, turn the request flag of initial data setting (RY0079) ON while the remote READY flag (RX007B) is active.

The AD-4408C turns the remote READY flag (RX007B) OFF and performs initial data settings.

When initial data settings are complete, the reply flag of initial data setting (RX0079) is turned ON.

Turn OFF the request flag of initial data setting (RY0079) in the master station.

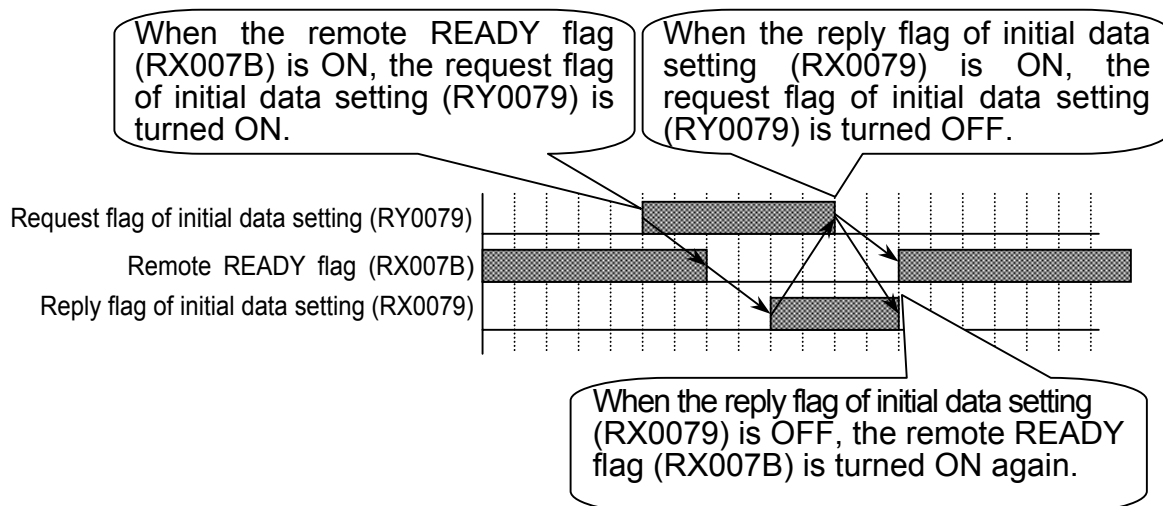

Fig.11 Performance of request flag of initial data setting

Write command

Specify the data type to write by the command No. (RWw000E).

Place the data to write in the command data (RWw000C to RWw000D).

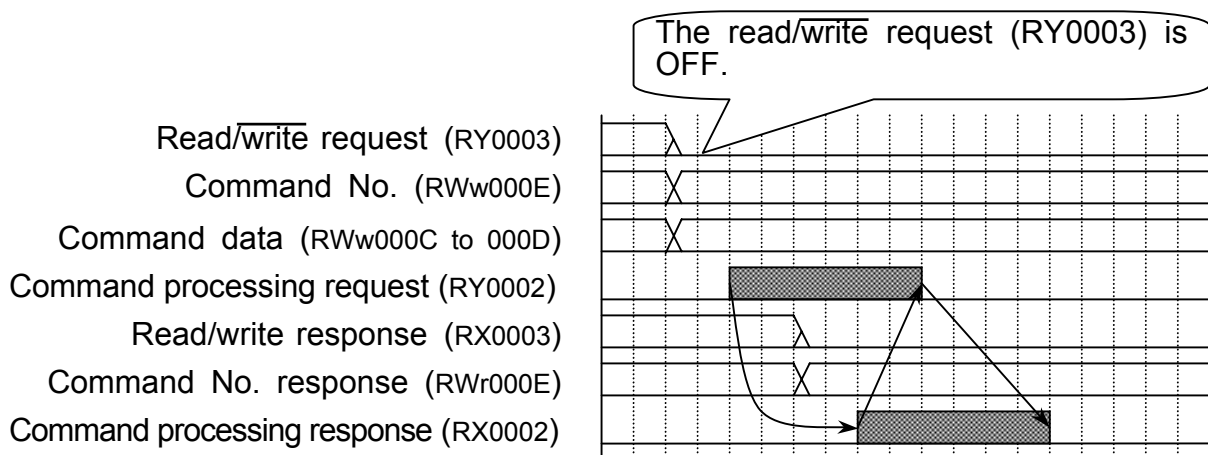

Fig.12 Performance of the write command

CPU normal operation

The CPU normal operation (RX0006) is a signal to check that the AD-4408C is turned on and it functions normally. During normal operation, the signal is reversed at an interval of 0.5 to 1 second.

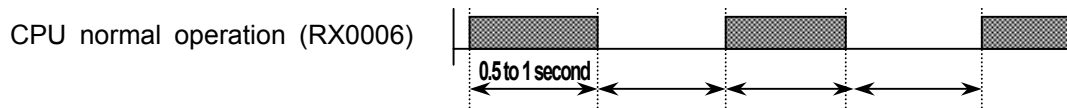

Fig.13 CPU normal operation signal

Error status flag

When an error occurs to the AD-4408C, the remote READY flag (RX007B) becomes inactive and the error status flag (RX007A) becomes active to inform the master station of the error occurrence.

The master station requests to reset the error status flag, by activating the request flag of error reset (RY007A).

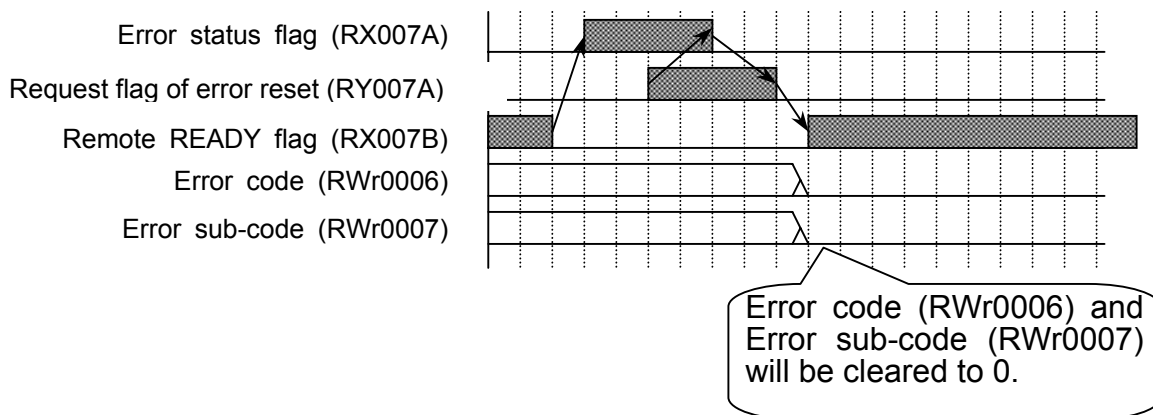

Fig.14 Resetting the error status flag



10. Maintenance

10.1. Error Messages

If an error message is displayed, refer to the chart below to take proper measures.

Error message	Cause	Remedy
<i>Ad Err</i>	Data can not be acquired from the A/D converter.	Repair is required.
<i>rA Err</i>	Data can not be written into the battery backup memory.	Repair is required.
<i>EEPErr</i>	Correct data can not be read from the EEPROM.	Perform initialization. If initialization does not clear the error, repair is required.
<i>CALErr</i>	Calibration data is not correct.	Perform calibration.
<i>Lb Err</i>	No battery backup. The zero and tare values are cleared.	Perform zero adjustment or clear the zero value. And then, update the zero value.
<i>[ErrX</i>	Calibration error	Refer to “7.4. Calibration Errors”.
<i>Err dt</i>	The setting value is out of the settable range.	Check the setting value and set again.

10.2. Check Mode

The check mode checks the performance of the display, key switches and external I/O.

10.2.1. Entering the check mode

Step 1 While holding down the ENTER key, press the F key.

[FnC] is displayed to indicate that the indicator will enter the general function mode.

To return to the weighing mode, press the ESC key.

Step 2 While holding down the ZERO key, press the ENTER key.

[hc] is displayed to indicate that the indicator will enter the check mode.

Press the ENTER key again to display an item to be checked.

Step 3 Press the or key to select the item to be checked and press the ENTER key to enter the check mode of the selected item.

To exit from the current mode, press the ESC key.

Display	Item to be checked
[hcEEY	Key switches
[hc LL	Standard serial output
[hc LL	CC-Link
[hc rS	Testing terminal
[hc Ad	A/D (Load cell)
[hc in	Internal count
[hcPr9	Program version
[S Pr9	Program checksum
[S EEP	Memory (EEPROM) checksum

10.2.2. Checking the key switches

With [hcEEY displayed, press the ENTER key to enter the key switch check mode. In the key switch check mode, six squares (□) are displayed. Each square corresponds to a key switch as shown below.

When a key switch is pressed, the corresponding square moves up (□).

When the CAL key is pressed, the minus LED turns ON.

To exit from the key switch check mode, press the ESC key twice.

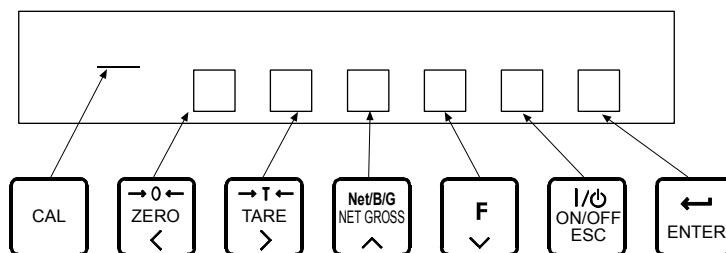

10.2.3. Checking the standard serial output

With [hc LL displayed, each time the ENTER key is pressed, the test data is transmitted with the baud rate set in the general functions and the decimal point blinks.

Test data [S T , G S , + 0 0 0 0 0 . 0 k g CR LF

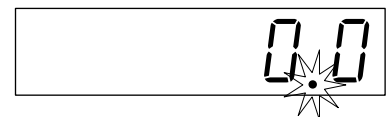

10.2.4. Checking the CC-Link

With $\boxed{[hc][L]}$ displayed, press the ENTER key to enter the CC-Link check mode.

Press the $\boxed{\Delta}$ or $\boxed{\nabla}$ key to change the address.

Press the CAL key to transmit the request flag of initialization.

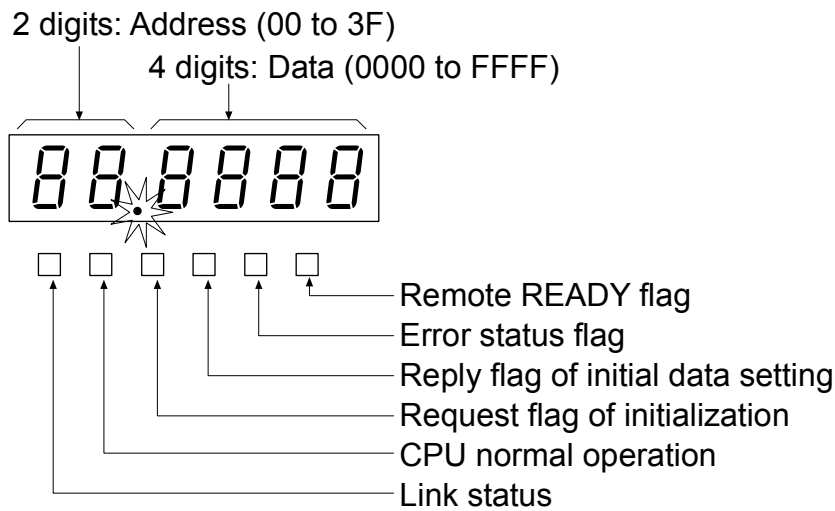

Address	Remote I/O	Buffer memory
05 to 0C	RY0000 to RY007F	160 to 167
0D to 1C	RWw0000 to RWw000F	1E0 to 1EF
25 to 2C	RX0000 to RX007F	0E0 to 0E7
2D to 3C	RWr0000 to RWr000F	2E0 to 2EF

10.2.5. Checking the testing terminal

The $\boxed{[hc][r5]}$ display is for checking the testing terminal. Do not use it.

10.2.6. Checking the A/D (load cell)

With $\boxed{[hc][Ad]}$ displayed, press the ENTER key to enter the A/D check mode. The load cell output value is displayed in mV/V.

The example below is when the internal count is 1.23456 mV/V.

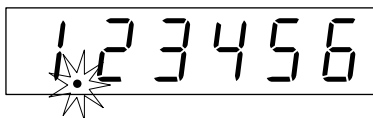

If the internal count exceeds $\pm 7\text{mV/V}$, the load cell may be damaged or the load cell may be connected incorrectly. Refer to "10.4. Checking the Load Cell Connection Using the Digital Multimeter" to check the connection.

10.2.7. Checking the internal count

With $\boxed{[hc][in]}$ displayed, press the ENTER key to enter the internal count check mode.

The internal count value (display value times 10) is displayed.

The example below is when the internal count is 123.

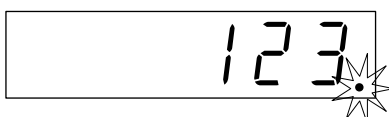

10.2.8. Checking the program version

With `[hcPr9]` displayed, press the ENTER key to display the version of the current program. The example below is when the program version is 1.00.

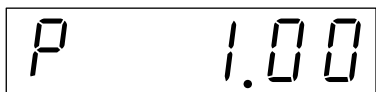
A rectangular LCD display showing the character 'P' on the left and the numerical value '1.00' on the right.

10.2.9. Checking the program checksum

With `[5 Pr9]` displayed, press the ENTER key to display the program checksum. The example below is when the checksum is EF.

A rectangular LCD display showing the character '5' on the left and the hexadecimal value 'EF' on the right.

10.2.10. Checking the EEPROM checksum

With `[5 EEP]` displayed, press the ENTER key to display the EEPROM checksum. The memory set in the general functions is not counted.

The example below is when the checksum is EF.

A rectangular LCD display showing the character '5' on the left and the hexadecimal value 'EF' on the right.

10.2.12. Checking the calibration-related functions

About the settings of the calibration-related functions, refer to “7.3. Calibration-Related Functions”.

10.3. Initialization Mode

The initialization restores the contents of the battery backup RAM and EEPROM to the default values.

The three types of initialization are available as shown below.

Initialization mode	Display	Description
RAM initialization	<i>in i rA</i>	Initializes the contents of the battery backup RAM only. As the zero and tare values are stored in the battery backup RAM, they will be restored to 0.
General functions initialization	<i>in iFnC</i>	Initializes the contents of the general functions stored in the battery backup RAM and EEPROM.
All data initialization	<i>in iALL</i>	Initializes all the contents in the battery backup RAM and EEPROM. The calibration-related data is also initialized. So, calibration is required before using the indicator again.

10.3.1. RAM initialization / General functions initialization

Step 1 While holding down the ENTER key, press the F key.

FnC is displayed to indicate that the indicator will enter the general function mode.

To return to the weighing mode, press the ESC key.

Step 2 While holding down the ZERO key, press the ENTER key.

[hc is displayed to indicate that the indicator will enter the check mode.

Step 3 Press the ▲ or ▼ key to select the initialization mode (in i) and press the ENTER key.

Step 4 Press the ▲ or ▼ key to select the item to be initialized and press the ENTER key.

Step 5 All the status LEDs blink to prompt a confirmation. To initialize, hold down the ENTER key for three seconds or more.

After initialization, the indicator is reset and all the display segments are ON. And the indicator enters the weighing mode.

To exit from this mode without performing initialization, press the ESC key.

10.3.2. All data initialization

- Step 1 Remove the cover concealing the CAL key and press the CAL key.
CAL is displayed to indicate that the indicator enters the calibration mode.
- Step 2 Press the ENTER key to display CALSET. The indicator enters the mode of calibration with an actual load. To return to the weighing mode, press the ESC key.
- Step 3 Press the Δ or ∇ key to select the all data initialization mode (in ALL) and press the ENTER key.
- Step 4 All the status LEDs blink to prompt a confirmation. To initialize, hold down the ENTER key for three seconds or more.
After initialization, the indicator is reset and all the display segments are ON.
And the indicator enters the weighing mode.
To exit from this mode without performing initialization, press the ESC key.

10.4. Checking the Load Cell Connection Using the Digital Multimeter

Using the digital multimeter, load cell connection can be checked easily.

The figure below indicates the measurement points to check the connection.

When a summing box is used, the same measurements are required inside the box.

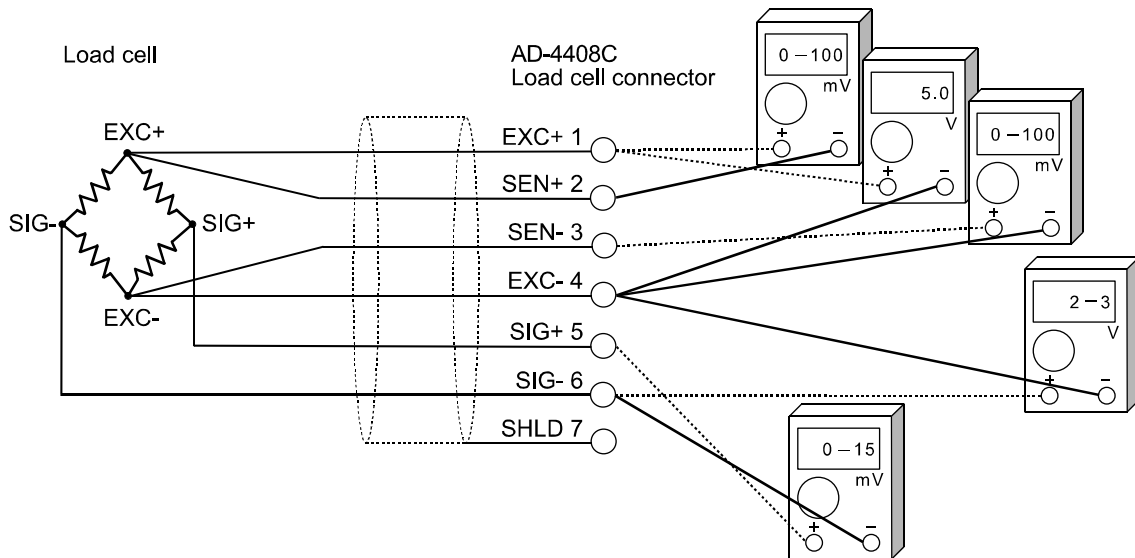

Fig.15 Checking the load cell connection

Checking the load cell connection

Measurement point		What to measure	How to judge
EXC+ 1	SEN+ 2	Voltage drop at EXC+ of the load cell cable	Normally less than 100mV. Can exceed 1V when the load cell cable is extremely long. Should be 0V for 4-wire connection.
EXC+ 1	EXC- 4	Load cell excitation voltage	Correct value: 4.75 to 5.25V
SEN- 3	EXC- 4	Voltage drop at EXC- of the load cell cable	Normally less than 100mV. Can exceed 1V when the load cell cable is extremely long. Should be 0V for 4-wire connection.
SIG- 6	EXC- 4	Load cell median voltage	About 2.5V (half of the excitation voltage)
SIG+ 5	SIG- 6	Load cell output voltage	Compared with the theoretical value obtained from the load cell rating, actual load and excitation voltage. Normally 0 to 15mV.

If the AD-4408C does not function properly, contact the nearest A&D dealer.

Use the chart below to write necessary items before contacting the dealer.

Item	Record your value	Description
Load cell connection	<input type="checkbox"/> 4-wire connection <input type="checkbox"/> 6-wire connection	For 4-wire connection, a jumper is required between EXC+ and SEN+, and between EXC- and SIG-.
Load cell type		
Load cell rating	[Unit]	
Load cell rated output	[mV/V]	
Load cell maximum safe overload	[%]	
Number of load cells used	[pcs]	
Summing box (status of use)		
Length of extension cable	[m]	Cable length between the indicator and the device such as a summing box
Indicator initial load	[Unit]	
Indicator minimum division	[Unit]	In case of decimal number, all the digits Example: 0.002 kg
Indicator weighing capacity	[Unit]	In case of decimal number, all the digits Example: 10.000 kg
Load cell output value at the initial load (at no load)	[mV/V]	-0.1mV/V to load cell rated sensitivity (depending on the initial load)
Load cell output value when loaded to capacity (or when a mass of choice is loaded)	Load cell output value [mV/V] at the load [Unit]	When loaded to capacity, the output value at the initial load + load cell rated output (within the maximum safe overload)

Measurement point		What to measure	Result
EXC+ 1	SEN+ 2	Voltage drop at EXC+ of the load cell cable	[mV]
EXC+ 1	EXC- 4	Load cell excitation voltage	[V]
SEN- 3	EXC- 4	Voltage drop at EXC- of the load cell cable	[mV]
SIG- 6	EXC- 4	Load cell median voltage	[V]
SIG+ 5	SIG- 6	Load cell output voltage	[mV]



11. Setting List

When performing maintenance, use the following list as a memo.

In case of inquiry about the product, inform of the user setting.

11.1. Basic Functions

Function No. Parameter or Setting range	Description	Default value	User setting
<i>FncF01</i> 000000 to 111111	Disable key switch 0: Does not disable the key switch function. 1: Disables the key switch function.	000000 (binary)	
<i>FncF02</i> 0 to 6	Assigns a function to the F key. 0: None 1: Manual print command 2: Hold 3: Alternate switch 4: Momentary switch 5: Clear the tare weight 6: Clear the zero value	0	
<i>FncF03</i> 1 to 3	Display update rate 1: 20 times/second 2: 10 times/second 3: 5 times/second	1	
<i>FncF04</i> 0 to 3	Assigns a function to the □ display. 0: None 1: Zero tracking in progress 2: Alarm (Zero range setting error, over, low battery) 3: F key status	0	
<i>FncF05</i> 0 to 9	Digital filter (cutoff frequency) 0: None 1: 11.0 Hz 2: 8.0 Hz 3: 5.6 Hz 4: 4.0 Hz 5: 2.8 Hz 6: 2.0 Hz 7: 1.4 Hz 8: 1.0 Hz 9: 0.7 Hz	8	
<i>FncF06</i> 1 to 10	Frequency divider ratio	1	
<i>FncF07</i> 1 to 2	Hold 1: Normal hold 2: Peak hold	1	

11.2. Standard Serial Output

Function No. Parameter or Setting range	Description	Default value	User setting
<i>[[F01</i> <i>1 to 5</i>	Output data <i>1</i> : Displayed weight <i>2</i> : Gross weight <i>3</i> : Net weight <i>4</i> : Tare weight <i>5</i> : Gross/Net/Tare	<i>1</i>	
<i>[[F02</i> <i>1 to 3</i>	Data transfer mode <i>1</i> : Stream <i>2</i> : Auto printing <i>3</i> : Manual printing	<i>1</i>	
<i>[[F03</i> <i>1 to 2</i>	Baud rate <i>1</i> : 600 bps <i>2</i> : 2400 bps	<i>2</i>	

11.3. CC-Link

Function No. Parameter or Setting range	Description	Default value	User setting
<i>[[F01</i> <i>1 to 64</i>	Station number <i>n</i> : Station number	<i>1</i>	
<i>[[F02</i> <i>0 to 2</i>	Number of occupied stations <i>0</i> : One <i>1</i> : Two <i>2</i> : Four	<i>2</i>	
<i>[[F03</i> <i>0 to 4</i>	Baud rate <i>0</i> : 156 kbps <i>1</i> : 625 kbps <i>2</i> : 2.5 Mbps <i>3</i> : 5 Mbps <i>4</i> : 10 Mbps	<i>4</i>	
<i>[[F04</i> <i>0 to 1</i>	Initialization <i>0</i> : Not required <i>1</i> : Required	<i>1</i>	
<i>[[F05</i> <i>0 to 2</i>	Output data <i>0</i> : Displayed weight <i>1</i> : Net weight <i>2</i> : Gross weight	<i>0</i>	

11.4. Calibration-Related Functions

Function No. Parameter or Setting range	Description	Default value	User setting
<i>CALF01</i> 0 to 3	Unit of the weight value 0: None 1: g 2: kg 3: t 4: lb (USA version)	2	
<i>CALF02</i> 0 to 5	Decimal point position of the weight value: 10 ⁿ	0	
<i>CALF03</i> 1 to 6	Minimum division (d) of the weight value 1: 1 2: 2 3: 5 4: 10 5: 20 6: 50	1	
<i>CALF04</i> 1 to 999999	Weighing capacity of the weighing instrument The decimal point position is the same as the setting of <i>CALF02</i> .	20000	
<i>CALF05</i> 0 to 100	Range to enable zero adjustment by the ZERO key or a command from the CC-Link master station. Expressed in percent of the weighing capacity with the calibration zero point as the center	2	
<i>CALF06</i> 0.0 to 5.0	Zero tracking time (Unit: second) When 0.0, zero tracking will not be performed.	0.0	
<i>CALF07</i> 0.0 to 9.9	Zero tracking band (Unit: 0.1 d) When 0.0, zero tracking will not be performed.	0.0	
<i>CALF08</i> 0.0 to 9.9	Stability detection time (Unit: second) When 0.0, stability detection will not be performed.	1.0	
<i>CALF09</i> 0 to 9	Stability detection band (Unit: d) When 0, stability detection will not be performed.	2	
<i>CALF10</i> 0 to 1	Tare and zero adjustment when the weight value is unstable. 0: Disables both functions. 1: Enables both functions.	1	
<i>CALF11</i> 0 to 1	Tare when the gross weight is negative. 0: Disables tare. 1: Enables tare.	1	
<i>CALF12</i> 0 to 1	Standard serial output if the weight value overflows and is unstable. 0: Disables output. 1: Enables output.	1	

Function No. Parameter or Setting range	Description	Default value	User setting
<i>CALF 13</i> 1 to 3	Condition to judge over when the gross weight is negative. A/D negative over or 1: Gross weight < -999999 2: Gross weight < negative weighing capacity 3: Gross weight < -19 d	1	
<i>CALF 14</i> 1 to 2	Condition to judge over when the net weight is negative. A/D negative over or 1: Net weight < -999999 2: Net weight < negative weighing capacity	1	
<i>CALF 15</i> 0 to 1	Select whether or not to clear the zero value. 0: Disables. 1: Enables.	1	
<i>CALF 16</i> 0 to 1	Select whether or not to perform zero upon power-ON. 0: Disables. 1: Enables.	0	
<i>CALF 17</i> -700000 to 700000	Input voltage from a load cell at zero. X.XXXXX mV/V	0.00000	
<i>CALF 18</i> 0.00001 to 999999	Input voltage from a load cell at span X.XXXXX mV/V	2.00000	
<i>CALF 19</i> 1 to 999999	The value of the calibration weight corresponding to the span input voltage	20000	
<i>CALF 20</i> 0 to 1	Select whether or not to output when the gross weight is negative. 0: Enables output. 1: Disables output.	0	
<i>CALF 21</i> 0 to 1	Select whether or not to restrict network-related communication. 0: Disables restriction. 1: Enables restriction.	0	
<i>CALF 22</i> 1 to 2	Second header for serial output 1: GS / NT / TR 2: G_ / N_ / T_ (_ space)	1	



12. External Dimensions

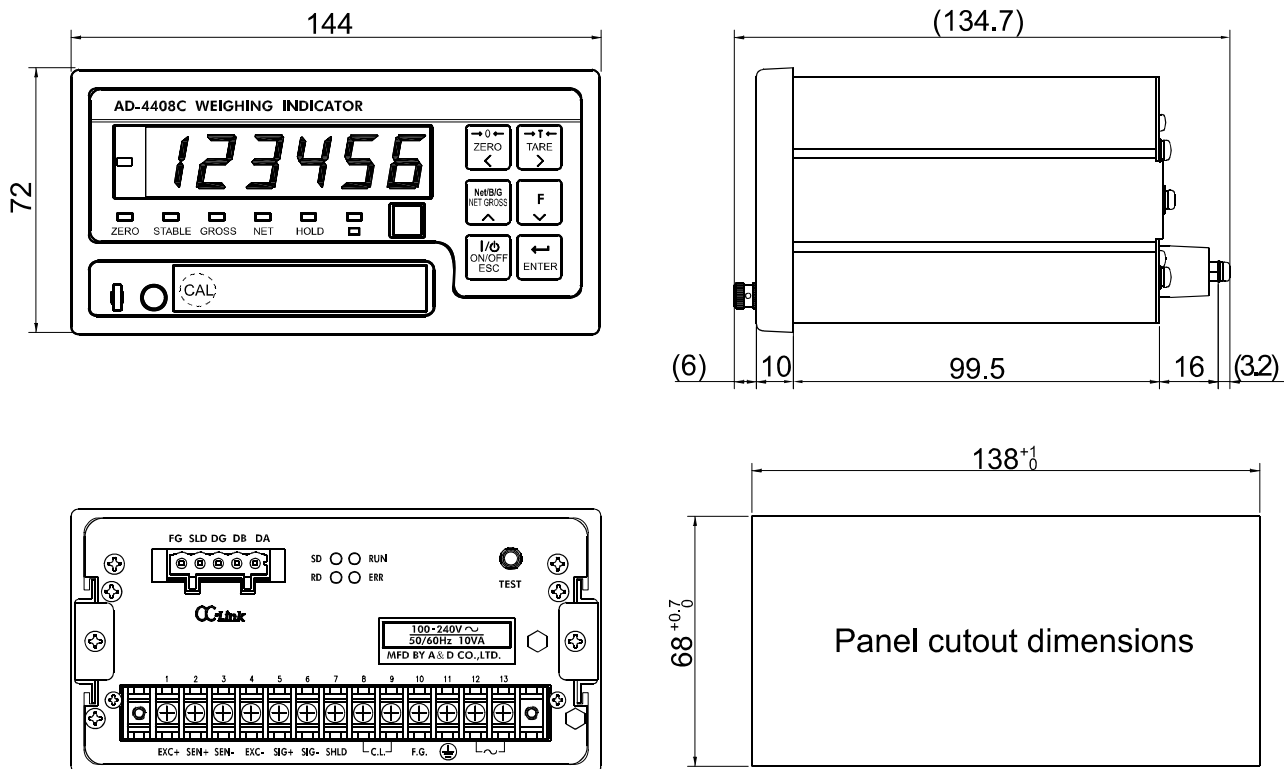

Unit: mm

Fig.16 External dimensions



A&D Company, Limited

3-23-14 Higashi-Ikebukuro, Toshima-ku, Tokyo 170-0013 JAPAN
Telephone: [81] (3) 5391-6132 Fax: [81] (3) 5391-6148

A&D ENGINEERING, INC.

1756 Automation Parkway, San Jose, California 95131 U.S.A.
Telephone: [1] (408) 263-5333 Fax: [1] (408)263-0119

A&D INSTRUMENTS LIMITED <UK Office>

Unit 24/26 Blacklands Way, Abingdon Business Park, Abingdon, Oxfordshire
OX14 1DY United Kingdom
Telephone: [44] (1235) 550420 Fax: [44] (1235) 550485

A&D INSTRUMENTS LIMITED <German Sales Office>

Große Straße 13 b 22926 Ahrensburg Deutschland
Telefon: [49] (0) 4102 459230 Telefax: [49] (0) 4102 459231

A&D Australasia Pty Ltd.

32 Dew Street, Thebarton, South Australia 5031 AUSTRALIA
Telephone: [61] (8) 8301-8100 Fax: [61] (8) 8352-7409

A&D KOREA Limited

한국에이.엔.디(주)
대한민국 서울시 영등포구 여의도동 36-2 맨하탄 빌딩 8층
(8th Floor, Manhattan Bldg. 36-2 Yoido-dong, Youngdeungpo-ku, Seoul, KOREA)
전화: [82] (2) 780-4101 팩스: [82] (2) 782-4280

A&D RUS CO., LTD.

Компания Эй энд Ди Рус
121357, Российская Федерация, г.Москва, ул. Верейская, дом 17
(Bldg. 17, Vereyskaya st., Moscow, 121357 RUSSIAN FEDERATION)
тел.: [7] (495) 937-33-44 факс: [7] (495) 937-55-66

A&D Instruments India Private Limited

ऐ&डी इन्स्ट्रूमेन्ट्स इण्डिया प्रा० लिमिटेड
509, उद्योग विहार , फेस -5, गुडगांव - 122016, हरियाणा , भारत
(509, Udyog Vihar, Phase-V, Gurgaon - 122 016, Haryana, India)
फोन : 91-124-4715555 फैक्स : 91-124-4715599