

AD-4402 OP-20

INSTRUCTION MANUAL

CC-Link Interface



This is a hazard alert mark.



This mark informs you about the operation of the product.

Note This manual is subject to change without notice at any time to improve the product. No part of this manual may be photocopied, reproduced, or translated into another language without the prior written consent of the A&D Company.

Product specifications are subject to change without any obligation on the part of the manufacture.

Copyright©2001 A&D Company, Limited



Contents

1.	Compliance.....	2
1.1.1.	Compliance with FCC rules.....	2
1.1.2.	Compliance with European Directives.....	2
2.	Outline and Features	3
2.1.	Precautions.....	3
3.	Panel	4
3.1.	Installing the Option.....	5
4.	Functions	6
4.1.	Remote I/O and Remote Registers.....	6
4.1.1.	Address Map of the Remote Register	6
4.1.2.	Address Map of the Remote Input / Output	8
4.2.	Communication Commands	12
4.2.1.	Reading Commands.....	12
4.2.2.	Storing Commands.....	13
4.3.	Timing Chart.....	15
4.3.1.	When Turning on the Indicator	15
4.3.2.	Resumption from the Suspended Mode.....	15
4.3.3.	Requesting Interface Initialization from the Master Unit	16
4.3.4.	Storing Setpoints.....	16
4.3.5.	Reading Commands.....	17
4.3.6.	Storing Commands.....	17
4.3.7.	CPU Signal.....	18
4.3.8.	Error Detection Flag	18
5.	Maintenance	19
5.1.	Monitor Mode.....	19
5.1.1.	Operation and Display.....	19



1. Compliance

1.1.1. Compliance with FCC rules

- Please note that this equipment generates, uses and can radiate radio frequency energy. This equipment has been tested and has been found to comply with the limits of a Class A computing device pursuant to Subpart J of Part 15 of FCC rules. These rules are designed to provide reasonable protection against interference when this equipment is operated in a commercial environment. If this unit is operated in a residential area it may cause some interference and under these circumstances the user would be required to take, at his own expense, whatever measures are necessary to eliminate the interference.
(FCC = Federal Communications Commission in the U.S.A.)

1.1.2. Compliance with European Directives

CE This appliance complies with the statutory EMC (Electromagnetic Compatibility) directive 89/336/EEC and the Low Voltage Directive 73/23/EEC for safety of electrical equipment designed for certain voltages.

Note: The displayed value may be adversely affected under extreme electromagnetic influences.



2. Outline and Features

- The CC link (Control & Communication link) is used to connect factory automation devices and control it by a master unit. Refer to the CC-link partner association vender regarding the details of this open system and each device.

The AD-4402 OP-20 is a **remote device station** of the CC link interface version 1.10.

- It is easy to construct the programs to control the AD-4402 because the option can control the indicator with the remote I/O and remote registers, or communication commands.



2.1. Precautions

Before any use, confirm the following articles for safe operation.

- CC-link connection
Conform to the specification of the CC link version 1.10.
- Grounding the option
Ground the option to an earth ground.
- Communication cable
Use a special shielded cable made by the CC-link partner vender.
- Wiring the cable
Separate the link wiring from other equipment wires such as a motor, inverter or a power source. Unless the CC-link wires are separated, an operation error may occur or it could cause the operator to receive an electric shock.
- Test mode
When using the indicator in test mode, remove CC-link connection to avoid operation error by other equipment on the link.



3. Panel

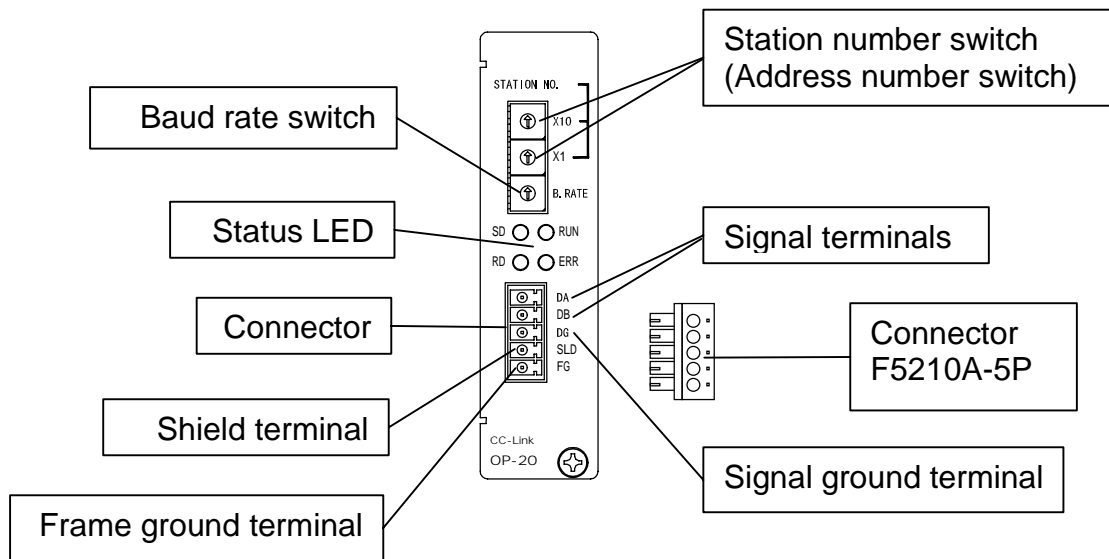

Station number switch

Station number range: 1 to 61.

Set the CC-link station number (address number).

This option occupies four station numbers.

Example: When the station number "1" is set, "1", "2", "3" and "4" are occupied.

Avoid any overlapped station numbers.

Baud rate switch

Switch No.	Baud rate
0	156 kbps
1	625 kbps
2	2.5 Mbps
3	5 Mbps
4	10 Mbps

Status LED

Name	Illuminated	Off	Blinking
RUN	Normal	Resetting No signal	
SD	Transmitting		
RD	Receiving		
ERR	Parameter error CRC error Station trouble	Normal	Changing parameter



3.1. Installing the Option

Caution

- ❑ Remove the power cord before installing the option.
 - ❑ Do not install the same options.
 - ❑ Do not touch any inside parts within ten seconds after removing the power cord because you may receive an electric shock.
 - ❑ Do not forget to tighten the screws. If a screw is not tightened, it may cause a short circuit or an error due to noise.
-
- ❑ Three option boards can be installed in the slots.
 - ❑ Initialize the RAM data in accordance with the proper procedure. Refer to the AD-4402 instruction manual for other information.

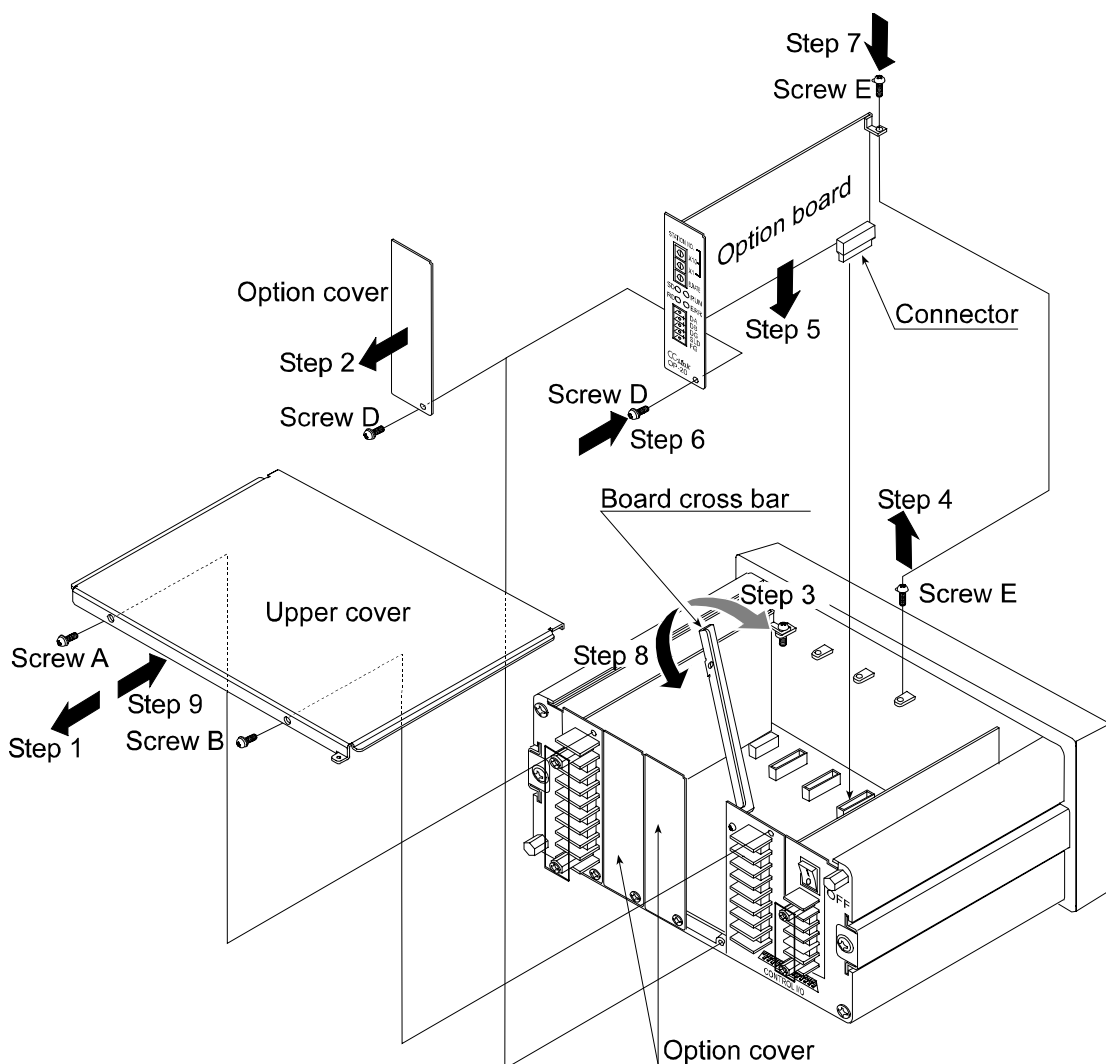



4. Functions

- The installed option can read the AD-4402 weighing data and write parameters to control it from the master station (EX. program controller of CC-link).
- There are two ways to operate the option.
 - Direct operation of the remote input and output with the remote registers.
 - The communication command operation.



4.1. Remote I/O and Remote Registers

4.1.1. Address Map of the Remote Register

Assumed that station No. is "1".

Remote Register for the AD-4402 to the Master Unit

Caution

- Do not write any parameter to addresses "Not used" by the remote output RY or remote register RWw. It may cause an operation error.
- The addresses "Not used" by the remote input RX and remote register RWr are variable.

Station No.	Remote register	Buffer	Description
1	RWr000	2E0	Net
	RWr001	2E1	
	RWr002	2E2	Gross
	RWr003	2E3	
2	RWr004	2E4	Total weight
	RWr005	2E5	
	RWr006	2E6	Kind of error 0: No alarm, no error 1: Weighing sequence error 2: Zero error 3: Alarm 1 4: Alarm 2
	RWr007	2E7	Error No.
3	RWr008	2E8	8 bits current material code
	RWr009	2E9	
	RWr00A	2EA	Not used
	RWr00B	2EB	
4	RWr00C	2EC	Command data reply 32 bits,
	RWr00D	2ED	
	RWr00E	2EE	Command code reply 16 bits,
	RWr00F	2EF	Not used

Master Unit to AD-4402

Station No.	Remote register	Buffer	Description
1	RWw000	1E0	Final, 24 bits
	RWw001	1E1	Material code to store, 8 bits
	RWw002	1E2	Optional preliminary 32 bits
	RWw003	1E3	
2	RWw004	1E4	Preliminary 16 bits
	RWw005	1E5	Free fall 16 bits
	RWw006	1E6	Over 16 bits
	RWw007	1E7	Under 16 bits
3	RWw008	1E8	Full 32 bits
	RWw009	1E9	
	RWw00A	1EA	Zero band 16 bits
	RWw00B	1EB	
4	RWw00C	1EC	Command data 32 bits
	RWw00D	1ED	
	RWw00E	1EE	Command code 16 bits
	RWw00F	1EF	Not used

Example of Numerical Number

Decimal numbers	Hexadecimal numbers		
	16 bits	24 bits	32 bits
-10	FFF6	FFFFFF6	FFFFFFFF6
-1	FFFF	FFFFFFF	FFFFFFFFF
0	0000	000000	00000000
1	0001	000001	00000001
10	000A	00000A	0000000A

4.1.2. Address Map of the Remote Input / Output

Flags (bits) and CC-link handshake in the **remote input**,

AD-4402 to Master Unit

Assumed that station No. is "1".

Station No.	Flags (bits) and CC-link Handshake of Remote Input	Buffer	Description	
1	RX0000	0E0	Reply flag to store setpoints	
	RX0001		Not used	
	RX0002		Command replay flag	
	RX0003		Read / Write replay flag	
	RX0004		Not used	
	RX0005			
	RX0006		CPU normal operation	
	RX0007		Not used	
	RX0008		Decimal point 2^0	Three bits binary
	RX0009		Decimal point 2^1	
	RX000A		Decimal point 2^2	
	RX000B to RX000F		Not used	
	RX0010		0E1	Zero band
	RX0011	Full flow		
	RX0012	Medium flow		
	RX0013	Dribble flow		
	RX0014	Over		
	RX0015	OK		
	RX0016	Under		
	RX0017	Stable		
	RX0018	Batch finish		
	RX0019	Capacity exceeded		
	RX001A	Hold		
	RX001B	Full		
	RX001C	Not used		
	RX001D	Discharge		
	RX001E	Weighing sequence error		
	RX001F	Abnormal weighing without weighing sequence error.(Zero error, Alarm 1, Alarm 2)		
	2	RX0020	0E2	Stable
RX0021		Zero band		
RX0022		Full		
RX0023		Full flow		
RX0024		Medium flow		
RX0025		Dribble flow		
RX0026		Over		
RX0027		OK		
RX0028		Under weight		
RX0029		Internal reservation		
RX002A				

Station No.	Flags (bits) and CC-link Handshake of Remote Input	Buffer	Description
2	RX002B	0E2	Mixing
	RX002C		Discharge
	RX002D		Batch finish
	RX002E		Recipe finish
	RX002F		Discharge finish
	RX0030	0E3	Mixture finish
	RX0031		Nozzle down
	RX0032		Online
	RX0033		Weighing sequence in process
	RX0034		Input acknowledged
	RX0035		Weighing sequence error
	RX0036		Alarm 1
	RX0037		Alarm 2
	RX0038		Zero error
	RX0039		Capacity exceeded
	RX003A		Buzzer
	RX003B		Tare
	RX003C		Center of zero
	RX003D		Gross display
	RX003E		Net display
RX003F	Hold		
3	RX0040	0E4	Material hopper 1
	RX0041		Material hopper 2
	RX0042		Material hopper 3
	RX0043		Material hopper 4
	RX0044		Material hopper 5
	RX0045		Material hopper 6
	RX0046		Material hopper 7
	RX0047		Material hopper 8
	RX0048		Material hopper 9
	RX0049		Material hopper 10
	RX004A		Material hopper 11
	RX004B		Material hopper 12
	RX004C		Material hopper 13
	RX004D		Material hopper 14
	RX004E		Material hopper 15
	RX004F		Material hopper 16
	RX0050	0E5	Material hopper 17
	RX0051		Material hopper 18
	RX0052		Material hopper 19
	RX0053		Material hopper 20
RX0054 to RX005F	Not used		

Station No.	Flags (bits) and CC-link Handshake of Remote Input	Buffer	Description
4	RX0060 to RX006F	0E6	Not used
	RX0070 to RX0077	0E7	Not used
	RX0078		Request flag of initialization
	RX0079		Reply flag of initial data setting
	RX007A		Error status flag
	RX007B		Remote READY flag
	RX007C to RX007F	Not used	

Flags (bits) and CC-link handshake in the **remote output**,

Master Unit to AD-4402

Assumed that station No. is "1".

Station No.	Flags (bits) and CC-link Handshake of Remote Input	Buffer	Description
1	RY0000	160	Request flag to store setpoints
	RY0001		Not used
	RY0002		Command request flag
	RY0003		Read/Write selection flag
	RY0004 to RY000F		Not used
	RY0010	161	Zero
	RY0011		Zero clear
	RY0012		Tare
	RY0013		Tare clear
	RY0014		Hold
	RY0015		Net display
	RY0016		Gross display
	RY0017		Not used
	RY0018		Total command
	RY0019		Total clear(Current material code)
	RY001A		Reset error. (Zero error, Alarm 1, Alarm 2)
	RY001B to RY001F		Not used
2	RY0020	162	Zero
	RY0021		Zero clear
	RY0022		Tare
	RY0023		Tare clear
	RY0024		Batch start
	RY0025		Recipe start
	RY0026		Discharge start
	RY0027		Mixing start

Station No.	Flags (bits) and CC-link Handshake of Remote Input	Buffer	Description
2	RY0028	162	Internal reservation
	RY0029		Manual free fall compensation
	RY002A		Total command
	RY002B		Cancel the last total
	RY002C		Emergency stop
	RY002D		Clear total of each material code that specified at the storing command No.33.
	RY002E		Clear total of each recipe code that specified at the storing command No.57.
	RY002F		Not used
	RY0030 to RY0034	163	Not used
	RY0035		Pause
	RY0036		Re-start
	RY0037		Clear total of current material code
	RY0038		Clear all totals of material code
	RY0039		Clear total of current recipe code
	RY003A		Clear all totals of recipe code
	RY003B to RY003F		Not used
3	RY0040	164	Not used
	RY0041		Not used
	RY0042		Not used
	RY0043		Force batch finish
	RY0044		Force recipe finish
	RY0045		Force discharge finish
	RY0046 to RY004A		Not used
	RY004B		Error reset
	RY004C		Not used
	RY004D		Not used
	RY004E		Manual print
	RY004F		Not used
	RY0050	165	Gross display
	RY0051		Net display
RY0052 to RY005F	Not used		
4	RY0060 to RY006F	166	Not used
	RY0070 to RY0077	167	Not used
	RY0078		Reply flag of initialization
	RY0079		Request flag of initial data setting
	RY007A		Request flag of error reset
	RY007B to RY007F	Not used	



4.2. Communication Commands

4.2.1. Reading Commands

Command name	Command code at RWw000E	Description
Material name 1 (character no. 1 to 4)	1	The command for material code. Select the material code before calling the code. Set the code number using "writing command code 33"
Material name 2 (character no. 5 to 8)	2	
Material name 3 (character no. 9 to 12)	3	
Material hopper	5	
Full	6	
Free fall	7	
Preliminary	8	
Optional preliminary	9	
Over	10	
Under	11	
Zero band	12	
Full	13	
Tare	14	
Supplementary flow open timer	15	
Supplementary flow close timer	16	
Automatic free fall range	17	
Initial dribble flow	18	
Initial medium flow	19	
Total weight	20	
Total count	21	
Current material code	32	
Material code to store	33	
Weighing result	36	To read the last result.
Recipe name 1 (character no. 1 to 4)	40	The command for recipe code. Select the recipe code before calling the code. Set the code number using "writing command code 57"
Recipe name 2 (character no. 5 to 8)	41	
Recipe name 3 (character no. 9 to 12)	42	
Material 1	44	
Material 2	45	
Material 3	46	
Material 4	47	
Material 5	48	
Material 6	49	
Material 7	50	
Material 8	51	
Material 9	52	
Material 10	53	
Total weight	54	
Total count	55	
Current recipe code	56	
Recipe code to store	57	

4.2.2. Storing Commands

Command name	Command code at RWw000E	Data of RWw000C, RWw000D	Description
Material name 1 (character no. 1 to 4)	1	Characters	The command for material code. Select the material code before calling the code. Set the code number using "writing command code 33"
Material name 2 (character no. 5 to 8)	2		
Material name 3 (character no. 9 to 12)	3		
Material hopper	5	Value	
Full	6		
Free fall	7		
Preliminary	8		
Optional preliminary	9		
Over	10		
Under	11		
Zero band	12		
Full	13		
Tare	14		
Supplementary flow open timer	15		
Supplementary flow close timer	16		
Automatic free fall range	17		
Initial dribble flow	18		
Initial medium flow	19		
Recall material code	32		
Material code to store	33		
Recipe name 1 (character no. 1 to 4)	40	Characters	The command for recipe code. Select the recipe code before calling the code. Set the code number using "writing command code 57"
Recipe name 2 (character no. 5 to 8)	41		
Recipe name 3 (character no. 9 to 12)	42		
Material 1	44	Value	
Material 2	45		
Material 3	46		
Material 4	47		
Material 5	48		
Material 6	49		
Material 7	50		
Material 8	51		
Material 9	52		
Material 10	53		
Recall recipe code	56	0 to 99	
Recipe code to store	57		

Caution

Use ASCII code.

Put a space code (20h) in material name or recipe name, when they are not used.

Command name	Command code at RWw000E	Data of RWw000C, RWw000D	Description
Zero	0	1	
Zero clear	0	2	
Tare	0	3	
Tare clear	0	4	
Batch start	0	5	
Recipe start	0	6	
Discharge start	0	7	
Mixing start	0	8	
Manual free fall compensation	0	10	
Total	0	11	
Cancel the last result	0	12	
Emergency stop	0	13	
Clear total of each material code	0	14	Set the material code at storing command No.33 before use
Clear total of each recipe code	0	15	Set the recipe code at storing command No.57 before use
Pause	0	22	
Re-start	0	23	
Clear accumulation data of active material code	0	24	
Clear all totals of material code	0	25	
Clear total of active recipe code	0	26	
Clear all totals of recipe code	0	27	
Forced batch finish	0	36	
Forced recipe finish	0	37	
Forced discharge finish	0	38	
Reset error	0	44	
Manual print command	0	47	
Net display	0	49	
Gross display	0	50	



4.3. Timing Chart

4.3.1. When Turning on the Indicator

- When initializing the interface from the indicator, use the following procedure.
When initializing the interface from the master unit, refer to "4.3.3. Requesting to initialize the interface from the Master Unit".
- When turning on the indicator each time, the following procedure is performed to initialize the option interface.
 - 1 When turning on the indicator and the option interface status is to be able to communicate, the **request flag of initialization (RX0078)** is active on the AD-4402 side.
 - 2 The master unit initializes the option interface and turns on the **reply flag of initialization (RY0078)**.
 - 3 AD-4402 turns off the **request flag of initialization (RX0078)** and turn on the **remote READY flag (RX007B)**
 - 4 Turn off the **reply flag of initialization (RY0078)** on the master unit side.

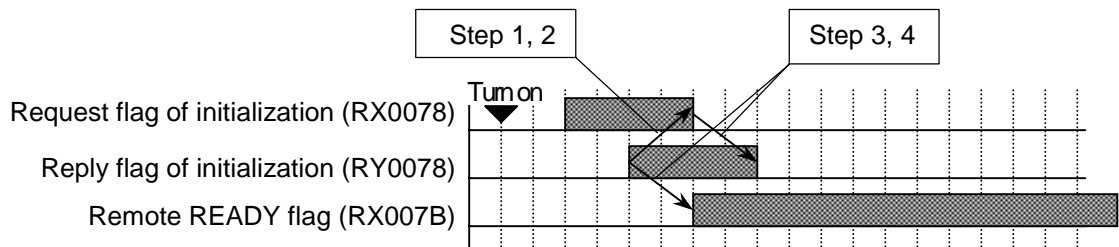

4.3.2. Resumption from the Suspended Mode

- The calibration mode, function list mode and standby mode are turn off by the **remote READY flag (RX007B)**.
When resuming from suspended mode, set the flag in the procedure "4.3.1. When Turning on the Indicator".

4.3.3. Requesting Interface Initialization from the Master Unit

- When initializing the interface from the master unit, use the following procedure. When initializing the interface from the indicator, refer to "4.3.1. When Turning on the Indicator".
- 1 When requesting initial setting of the option interface from the master unit, turn on the **request flag of initial data setting** (RY0079) during turning on the **remote READY flag** (RX007B).
- 2 AD-4402 turns off the **remote ready flag** (RX007B) and initializes it.
- 3 The **reply flag of initial data setting** (RX0079) is turned on.
- 4 Turn off the **request flag of initial data setting** (RY0079) on the master side.
- 5 AD-4402 turns on the **remote READY flag** (RX007B).

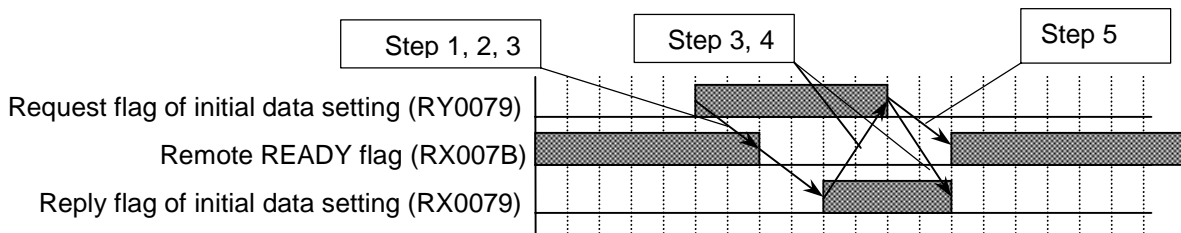

4.3.4. Storing Setpoints

- This command can store setpoints with reference the **remote register** (RWw0000 to RWw000B).
- 1 Set a **material code** to the upper side 8 bits of the **remote register** (RWw0001) that is in hexadecimal numbers.
- 2 Set zero to the parameter that is not used.
- 3 Turn on the **request flag** (RY0000) after storing parameters of the **remote register** (RWw0000 to RWw000B) to the indicator.
- 4 When the **reply flag** (RX0000) is turned on, the **request flag** (RY0000) is tuned off.

Master Unit to AD-4402

Station No.	Remote register	Buffer	Description
1	RWr000	1E0	Final, 24 bits
	RWr001	1E1	Material code to store, 8 bits
	RWr002	1E2	Optional preliminary 32 bits
	RWr003	1E3	
2	RWr000	1E4	Preliminary 16 bits
	RWr001	1E5	Free fall 16 bits
	RWr002	1E6	Over 16 bits
	RWr003	1E7	Under 16 bits
3	RWr000	1E8	Full 32 bits
	RWr001	1E9	
	RWr002	1EA	Zero band 16 bits
	RWr003	1EB	

} Setpoints

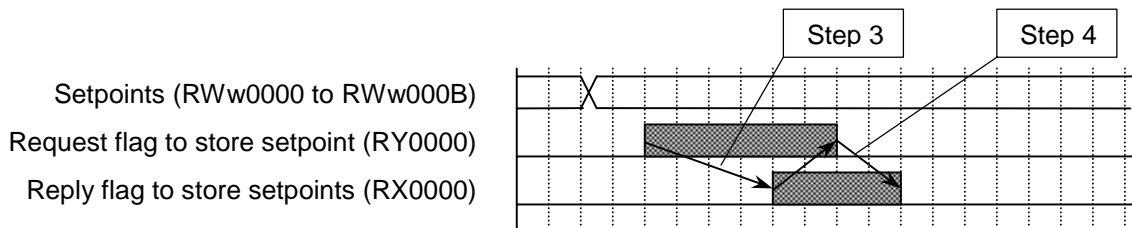

4.3.5. Reading Commands

- 1 Set a material code (No. 33) or recipe code (No. 57) in the **storing command** (RWw000E).
- 2 Turn on the **Read/Write selection** (RY0003).
- 3 Set the kind of data to the **command code** (RWw000E)
- 4 The result is output to the **reply register** (RWr000C to 000D).

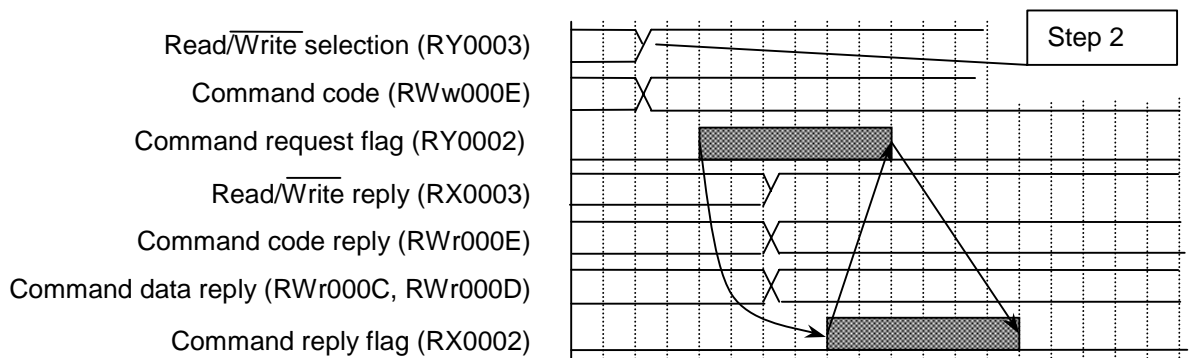

4.3.6. Storing Commands

- 1 Set a material code (No. 33) or recipe code (No. 57) in the **storing command** (RWw000E).
- 2 Turn off the **Read/Write selection** (RY0003).
- 3 Set the kind of data to the **command code** (RWw000E)
- 4 Set data to the **command register** (RWw000C, RWw000D).

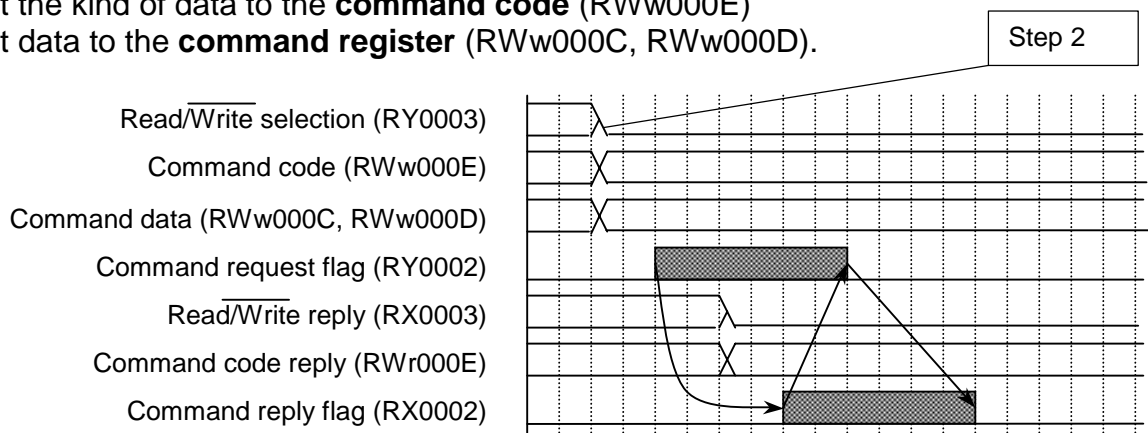

4.3.7. CPU Signal

- When the AD-4402 indicator status is normal, the **CPU normal operation flag register (RX0006)** outputs the following signal.

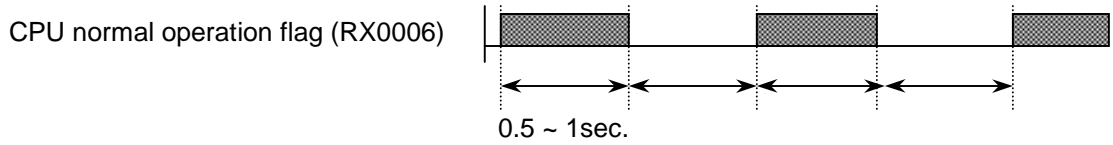

4.3.8. Error Detection Flag

- 1 When an error is detected, the **remote READY flag (RX007B)** is turned off and the **error status flag (RX007A)** turn off, to inform of the error.
- 2 The master unit requests to reset the error with the **error reset request flag (RY007A)**.

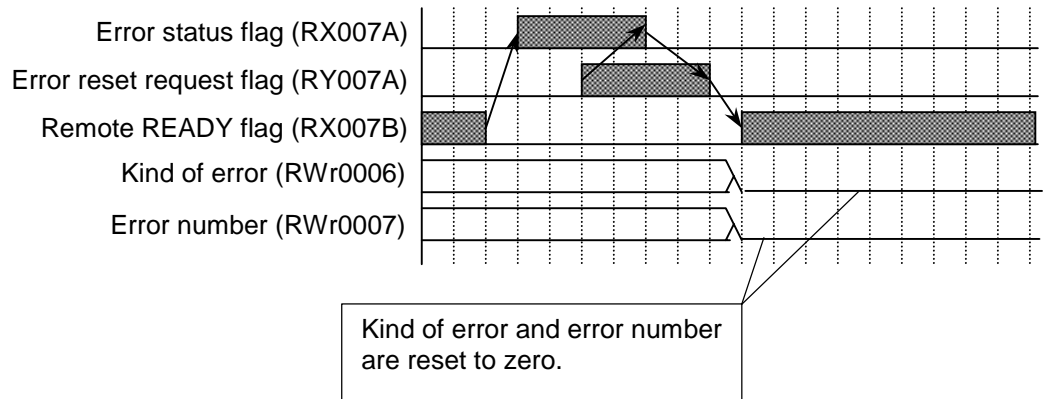



5. Maintenance



5.1. Monitor Mode

- The monitor mode is used to check the indicator during the weighing sequence.

5.1.1. Operation and Display

To enter the monitor mode

Press and hold the **ENTER** key and press the \updownarrow key in weighing mode.
 Select the menu **check** using the \updownarrow key and the **ENTER** key.
 Select menu **Option** and the OP-20 slot.

To select the kind of data of RX, RY, RWr, RWw

The \blacktriangle key or \blacktriangledown key

To select an I/O No. or register No.

The \updownarrow , \blacktriangle key or \blacktriangledown key

To exit the mode
(To return to weighing mode)

The **ESC** key.

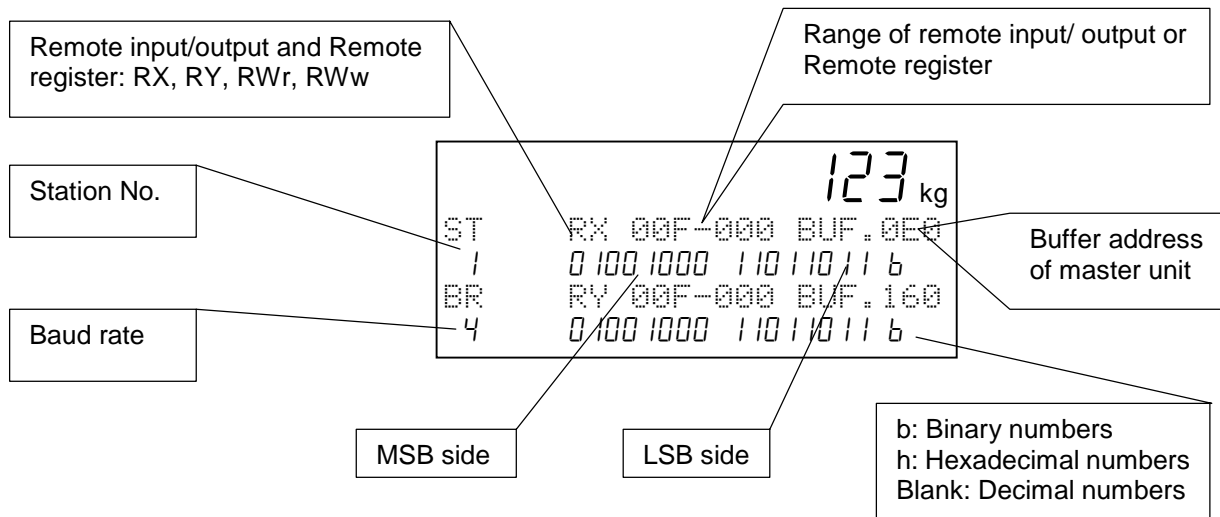

[Blank page]



A&D Company, Limited

3-23-14 Higashi-Ikebukuro, Toshima-ku, Tokyo 170-0013 JAPAN
Telephone: [81] (3) 5391-6132 Fax: [81] (3) 5391-6148

A&D ENGINEERING, INC.

1555, McCandless Drive, Milpitas, CA. 95035 U.S.A.
Telephone: [1] (408) 263-5333 Fax: [1] (408)263-0119

A&D INSTRUMENTS LTD.

Unit 24/26 Blacklands Way, Abingdon Business Park, Abingdon, Oxon OX14 1DY United Kingdom
Telephone: [44] (1235) 550420 Fax: [44] (1235) 550485

<German Scales Office>

Berner Straße 64, 60437 Frankfurt/Main 50 GERMANY
Telephone: [49] (69) 507-1017 Fax:[49] (69) 507-2054

A&D MERCURY PTY. LTD.

32 Dew Street, Thebarton, South Australia 5031 AUSTRALIA
Telephone: [61] (8) 8352-3033 Fax: [61] (8) 8352-7409

A&D KOREA Limited

8th Floor, Manhattan Bldg. 36-2 Yoido-dong, Youngdeungpo-ku, Seoul, KOREA
Telephone: [82] (2) 780-4101 Fax: [82] (2) 782-4280