

# AD-4325A

WEIGHING INDICATOR

## INSTRUCTION MANUAL

---

Owners-AD-4325A-v.4.a. 91.10.11 OGA

Calibration Errors .....	page C • 13
<b>Section D • Set Points</b> .....	page D • 1
About Set Point Displays .....	page D • 2
Set Point Procedure .....	page D • 2
Set Point Code .....	page D • 3
Set Point Values .....	page D • 5
Entering Decimal Points .....	page D • 6
About Sub Mode .....	page D • 7
Sub Mode Clearing Functions .....	page D • 7
Set Point Clearing Procedure .....	page D • 7
Accumulated Value and Count Clearing .....	page D • 9
Sub Mode Printing Procedure .....	page D • 10
Sub Mode Errors .....	page D • 13
<b>Section E • System Check</b> .....	page E • 1
System Check Procedure .....	page E • 2
<b>Section F • F-Functions</b> .....	page F • 1
About the F-Functions .....	page F • 2
Changing the F-Functions .....	page F • 3
F-Function Errors .....	page F • 5
F-Functions Listed .....	page F • 5
The F-Functions Settings .....	page F • 8
For Batch Weighing .....	page F • 11
'F 19' Accumulated Value and Count Clearing .....	page F • 15
Front Panel Keys .....	page F • 16
For Standard Current Loop .....	page F • 16
For BCD Option OP-01 .....	page F • 17
For Serial Interface Option OP-03/04 .....	page F • 18
For Analog Option OP-07 .....	page F • 19
<b>Section G • I/O Interfacing</b> .....	page G • 1
Control I/O External Interface .....	page G • 2
Screw Arrangement .....	page G • 2
Control I/O Circuitry .....	page G • 4
Normal Batching 'F 15' is set at "01", "11" or "21" .....	page G • 5
Loss-in-Weight 'F 15' is set at "02", "12" or "22" .....	page G • 8
Normal Batching 'F 15' is set at "03", "13" or "23" .....	page G • 11
Loss-in-Weight 'F 15' is set at "04", "14" or "24" .....	page G • 15
Multiple-Ingredient Batching .....	page G • 18

Standard Serial Output .....	page G • 22
Code Input Connector .....	page G • 24
Output Circuitry .....	page G • 24
Pin Assignments .....	page G • 24
Code Input Wiring Diagram .....	page G • 24
<b>Section H • Options</b> .....	page H • 1
Parallel BCD Output Option OP-01 .....	page H • 2
Transmission Mode .....	page H • 2
BCD Output Circuitry .....	page H • 2
Pin Assignments .....	page H • 3
Relay Output Option OP-02 .....	page H • 5
Specifications .....	page H • 5
RS-422 Interface Option OP-03 .....	page H • 6
Interface Circuit Diagram .....	page H • 8
RS-232C Interface Option OP-04 .....	page H • 9
Transmission Mode .....	page H • 9
Specifications .....	page H • 10
RS-232C Pin Connection .....	page H • 10
Current Loop Pin Connection .....	page H • 11
Output Circuit Diagram .....	page H • 11
RS-232C Data Formats .....	page H • 12
Formatting Example .....	page H • 12
Header 1 .....	page H • 12
Header 2 .....	page H • 12
Unit Indicator .....	page H • 13
HEX Code Inputs .....	page H • 13
Data Format #1 .....	page H • 13
Data Format #2 .....	page H • 14
'F 43' = "1" Stream Mode .....	page H • 14
'F 43' = "2" Auto Print Mode .....	page H • 14
'F 43' = "3" Manual Print Mode .....	page H • 14
'F 43' = "4" Command Mode #1 .....	page H • 15
'F 43' = "5" Command Mode #2 .....	page H • 16
'F 43' = "6" Accumulate and Print Mode .....	page H • 19
Analog Output Option OP-07 .....	page H • 20
Transmission .....	page H • 20
Specifications .....	page H • 20
Output Circuitry .....	page H • 21

'F 53' - Setting Output Current ..... page H • 21  
Analog Connector ..... page H • 22  
*Dimensions* ..... page vi





## Compliance with FCC Rules

Please note that this equipment generates, uses and can radiate radio frequency energy. This equipment has been tested and has been found to comply with the limits of a Class A computing device pursuant to Subpart J of Part 15 of FCC rules. These rules are designed to provide reasonable protection against interference when equipment is operated in a commercial environment. If this unit is operated in a residential area it might cause some interference and under these circumstances the user would be required to take, at his own expense, whatever measures are necessary to eliminate the interference.

(FCC = Federal Communications Commission in the U.S.A.)

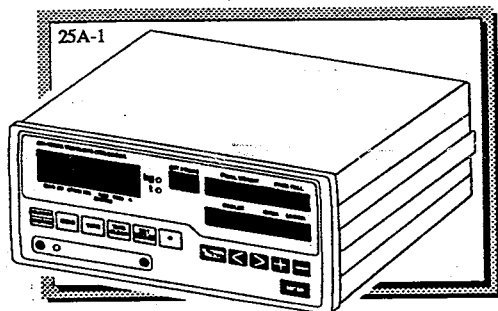

# AD-4325A • Section A

# Introduction



# Welcome!

Thank You for Your **A&D** Purchase!

*This is the INSTRUCTION MANUAL for the AD-4325A Weighing Indicator. The AD-4325A is the product of years of design, development, and in-field testing. It is designed to withstand harsh environmental conditions – and each indicator is subjected to several levels of quality control before it leaves the factory. Every care has been taken during the manufacturing process of this indicator to ensure that it will perform accurately and reliably for many years.*

Speed, accuracy and reliability set the AD-4325A Indicator apart from every other unit in its class. 70 times-per-second high-speed sampling makes the AD-4325A ideal for dynamic weighing applications. A built-in computer software system allows up to 100 coded batch operations to be stored. The AD-4325A possesses Final Weight, Free Fall, Preliminary and Under and Over Weight storage capacity. Full Digital Calibration (FDC) is quick and easy, and Zero Point and Span adjustments can be made at the touch of a button.

Like its A&D predecessors, the AD-4325A is designed for flawless performance in demanding industrial applications. The analog section is completely sealed against RFI interference and A&D's Watchdog™ circuitry automatically resets the unit if a software crash develops - for uninterrupted weighing. A sealed front panel keeps out dirt, and the fluorescent and LED displays can be easily read in any light. Housed in a rugged case, the AD-4325A is designed for easy panel-mounting. Modern industry demands equipment that is both versatile and easily connectable to other devices. A Serial Out is standard for easy connection to a printer or scorecard. Data Out provides RS-232C and BCD interface connection capabilities. A Control I/O connector makes Batch Weighing a snap, and a Relay Output is available as well. A&D offers a number of high-quality printers to satisfy a wide range of hard copy requirements.



## Features

- High speed A/D converter - up to 70 times per second.
- Stores up to 100 coded groups of Set Point values with running totals for each group. Set Points are: Final Weight, Free Fall, Preliminary, and Over/Under.
- Simple calibration via FDC (Full Digital Compensation) function with one-touch Zero Point and Span adjustment.
- WATCHDOG** circuitry virtually eliminates malfunctions commonly associated with computerized equipment.
- Screened against **RFI** (Radio Frequency Interference).
- Standard Serial Out for printer hook-up.
- Convenient optional interfaces, parallel BCD (Binary-Coded-Decimal), Serial RS-422, RS-232C/Current Loop (Passive) and Analog Output.
- High display resolution of 1/10000 coupled with high accuracy.



# Front Panel Description

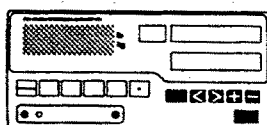
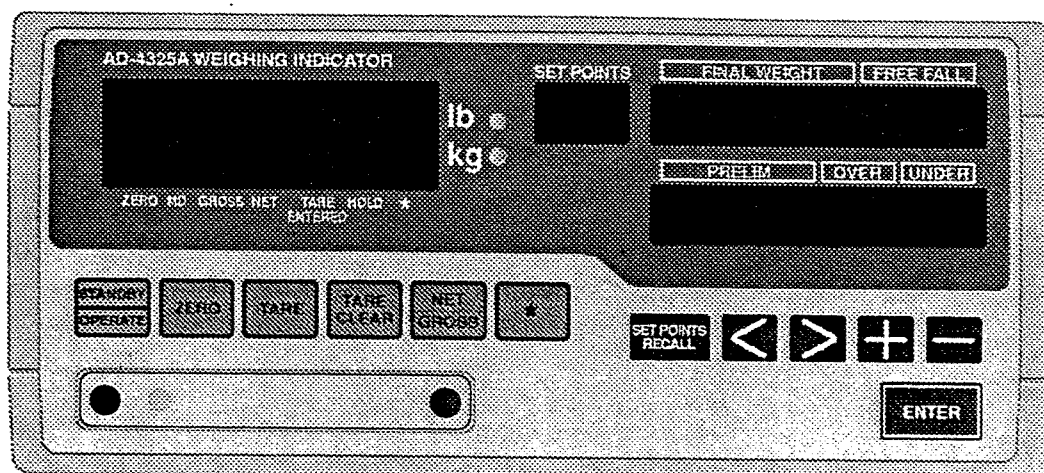

## *The Main Display*

The Main Display provides all the weighing data from the Load Cell(s) – as well as displays the annunciators explained later in this section.

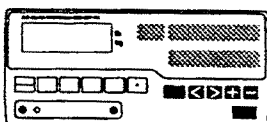

## *The Set Point Displays*

The three Set Point Displays provide handy Set Point information and setting – as well as display the System Check, Calibration, Re-Install, Sub Mode and all the F-Functions. See 'SET POINT PROCEDURE', D-2, 'SYSTEM CHECK PROCEDURE', E-2, 'FULL CALIBRATION PROCEDURE', C-5, 'RE-INSTALLING PROCEDURE', B-13, 'ABOUT SUB MODE', D-7, 'ABOUT THE F-FUNCTIONS', F-2, and 'F-FUNCTIONS SETTINGS', 'F 20', F-16, for more details.

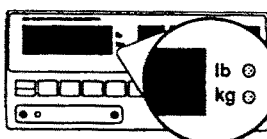

## *The Unit Indicator Lamps*

The **lb** annunciator will be lit when the AD-4325A is in pound weighing mode - the displayed weight is in pounds. *note: lb/kg version only (USA)*

The **kg** annunciator will be lit when the AD-4325A is in kilogram weighing mode - the displayed weight is in kilograms.

The **t** annunciator will be lit when the AD-4325A is in tonne weighing mode - the displayed weight is in tonne. *note: International version only.*

***The Unit Indicator will remain ON in STANDBY mode.***

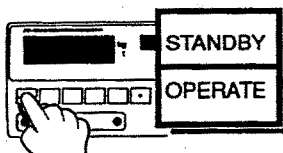

## The STANDBY/OPERATE Key

The **STND/OPR** key switches the AD-4325A between STANDBY and OPERATE mode. In STANDBY mode the displays will be OFF and all data output will stop. In OPERATE mode the displays will be ON and all Function keys will work. Your power cord must be disconnected from the Rear Panel to actually stop power to the weighing indicator. The Unit Indicator lamp will remain ON in STANDBY mode.

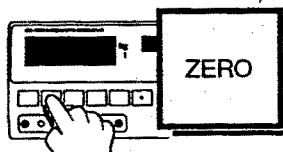

## The ZERO Key

The **ZERO** key returns the display to the center of ZERO when the weighing device is empty (user selected within  $\pm 2\%$  or 10% of the Maximum Capacity, see F-Function 'F 05', F•9), and motion is not detected (the  $\nabla$ MD annunciator is **not** on). It should not be confused with the **TARE** key which re-ZERO's the display and switches to NET mode.

While pressing the **ZERO** key and the **TARE CLR** key at the same time, Re-Install mode is accessed. See 'RE-INSTALLING PROCEDURE', B•13.

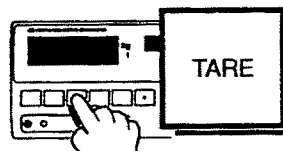

## The TARE Key

The **TARE** key switches to NET mode, ZERO's the display and stores the TARE weight in memory (the  $\nabla$ MD annunciator is OFF). The TARE Entered ( $\nabla$ TARE) Annunciator will be lit. Maximum TARE value is Maximum Capacity, regardless of the decimal point position (if any). Maximum Capacity is also the maximum display value which can be stored as TARE when in GROSS mode.

The **TARE** key is also used in accessing the Re-Install mode. See 'RE-INSTALLING PROCEDURE', B•13.

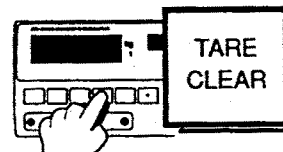

## The TARE CLEAR Key

The Tare Clear Key clears any Tare value already entered. The Tare Entered ( $\nabla$ TARE) Annunciator will go OFF when the **TARE CLR** key is pressed.

While pressing the **ZERO** key and the **TARE CLR** key at the same time, Re-Install mode is accessed. See 'RE-INSTALLING PROCEDURE', B•13.

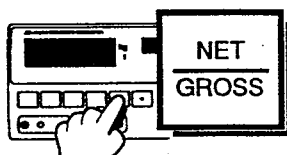

## The NET/GROSS Key

The **NET/GROSS** key switches between NET weight and GROSS weight. The annunciators and display will alternate between NET and GROSS as well.

Press the **NET/GROSS** key and the **STND/OPR** key, at the same time, to enter the Sub Mode. See 'ABOUT SUB MODE', D-7.

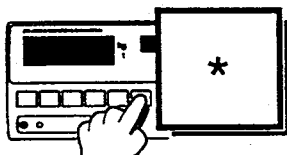

## The Star Key

The **\*** key switches between Normal mode and Accumulation mode when F-Function 'F 19' is set at "2", and displays the last Set Point Code entered when 'F 19' is set at "1" (see 'F 19', F-14).

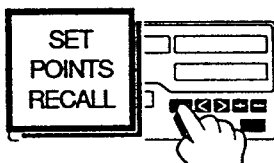

## The SET POINTS RECALL Key

Use the **S.P.R.** key to enter the Set Point Code-Setting mode. See 'SET POINT CODE', D-3.

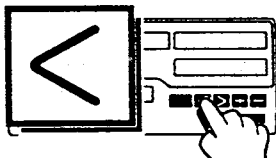

## Move Left Key

Use the **<** key when using the Set Point displays.

- ▶ Press the **<** key and the blinking cursor will move one digit to the left.

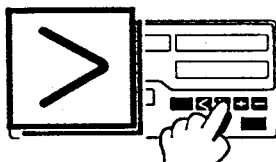

## Move Right Key

Use the **>** key when using the Set Point displays.

- ▶ Press the **>** key and the blinking cursor will move one digit to the right.

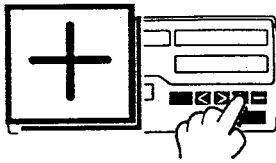

## The Add Key

Use the **[+]** key when using the Set Point displays.

- ▶ When you press the **[+]** key the digit that is blinking will increase by one.

12345678

12445678

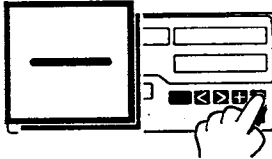

## The Subtract Key

Use the **[-]** key when using the Set Point displays.

- ▶ When you press the **[-]** key the digit that is blinking will decrease by one.

12345678

12245678

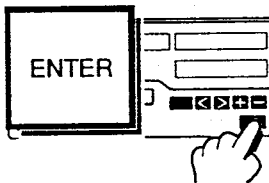

## The ENTER Key

The **[ENTER]** key stores data from the Set Point displays.



## The ZERO Annunciator

The ZERO (**▼ZERO**) annunciator will appear when the display is showing the center of ZERO.

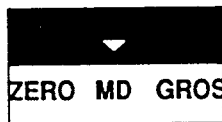

## The MD Annunciator

The Motion Detection (**▼MD**) annunciator will appear when the display is unstable due to weighing device motion.



## The GROSS Annunciator

The GROSS (**▼GROSS**) annunciator will appear when the display is in the GROSS mode, the display showing the GROSS weight.



## ***The NET Annunciator***

---

The NET (▼NET) annunciator will appear when the display is in the NET mode, the display showing the NET weight.



## ***The TARE ENTERED Annunciator***

---

The TARE Entered (▼TARE) annunciator will appear when a TARE weight has been entered and stored.



## ***The HOLD Annunciator***

---

The Hold (▼HOLD) annunciator will appear when F-Function 'F 09' is set to "1" or "2" (see F•10). When a Hold input is entered, the Comparison result and the display will be locked and the Hold (▼HOLD) annunciator will come ON.





## The Star Annunciator

The Star (▼\*) annunciator will appear when the [▼\*] key is held and when the Accumulated Count and Value are displayed. See 'THE STAR KEY', A-5.

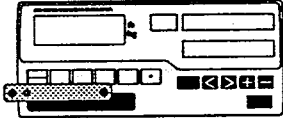

## The Dip-Switches

Remove the Dip-Switch cover located under the under the keys by turning the two knobs counter-clockwise. The four Dip-Switches are located underneath. If you flip the Dip-Switch cover over you will be able to read the four different modes (below).

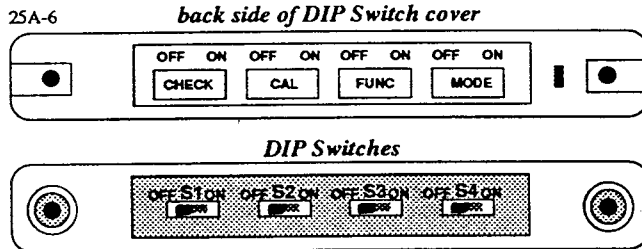
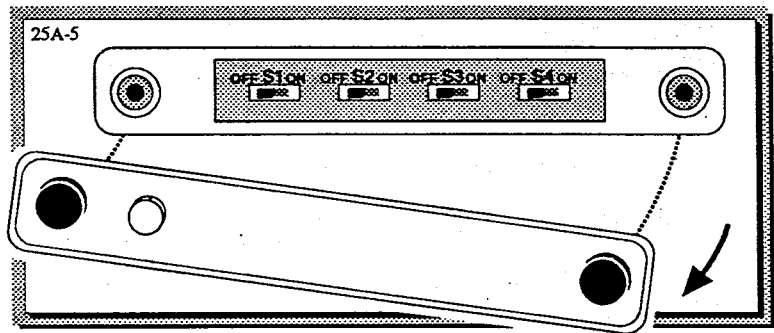

Dip-Switch "S1" is for the Systems Check. See 'SYSTEM CHECK PROCEDURE', E-2.

Dip-Switch "S2" is for Calibration. See 'FULL CALIBRATION PROCEDURE', C-5.

Dip-Switch "S3" is for the F-Function mode. See 'CHANGING THE F-FUNCTIONS', F-3.

Dip-Switch "S4" is for Front Panel key enable/disabling. See 'F-FUNCTION SETTINGS', 'F 20', F-16.



# Rear Panel Description

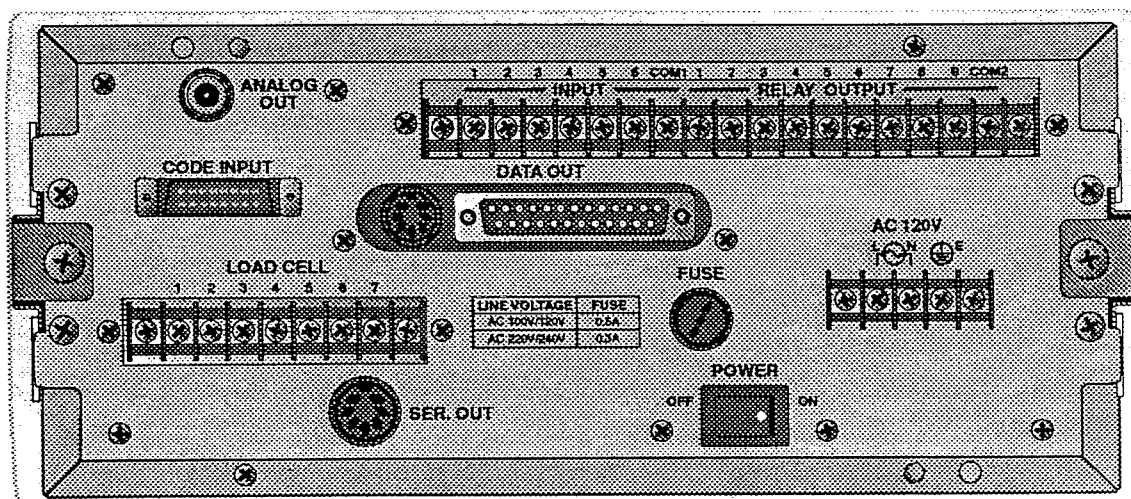

Pictured with Analog Output Option (OP-07), Optional Serial Interface (OP-04) and Relay Output Option (OP-02). A voltage of AC 120V (USA standard) is also shown.

## Analog Output

The Connector for the optional (OP-07) Analog Output, 4→20mA is marked "ANALOG OUT". See 'ANALOG OUTPUT', H-15.

## Code Input

The Code Input is for the attachment of a digital switch used to input Set Point code numbers; Set point values cannot be stored using this input. See 'CODE INPUT CONNECTOR', G-20.

## Data Output

The "DATA OUT," window provided is for the BCD Output Connector Option (OP-01) or the Serial Interface Connector Option (OP-03/04). Only one of the three options can be installed. The Serial Interface is shown in the drawing above.

- **BCD Output Connector** - Parallel Binary-Coded-Decimal Output Connector Option (OP-01) is for sending weight data to a printer, remote display, or PLC (Programmed Logic Control). See 'PARALLEL BCD OUTPUT', H-2.
- **Serial Interface Connector** - RS-422 Option (OP-03) is available with this option. See 'RS-422 Interface', H-6.
- **Serial Interface Connector** - Two types of serial interfaces are available with this option, the RS-232C and Current Loop interfaces (OP-04). For more information see 'RS-232C INTERFACE', H-9.

---

## *Control I/O*

---

The Control I/O is the long series of screws marked "INPUT" and "OUTPUT". The Control I/O provides Batch weighing control that can be driven by customer-generated software or the built-in program. For more information, see 'CONTROL I/O EXTERNAL INTERFACE' on G•2. Also, see 'RELAY OUTPUT' on H•5.

---

## *AC Input*

---

AC Input is labeled with the Standard AC voltage of the country in which the unit was purchased. Be careful when connecting the AC cable, a mis-wire can blow the power fuse, so please read 'UNPACKING & SETTING UP' first, B•2.

---

## *Power Switch*

---

The Power Switch is simply marked "POWER". Keep the power ON when not in use and use the **STNDVOPR** key to switch off. Turn off the power only when you are going to move the AD-4325A, or if you are going to attach or dis-attach anything from the rear panel.

---

## *Fuse*

---

The Fuse can be removed by unscrewing the Fuse Holder counter-clockwise. Use the correct fuse for the voltage used in your country.

Line Voltage	Fuse
AC 100V ~120V	0.5A
AC 220V ~240V	0.3A

---

## *Serial Output*

---

The Serial Output, marked "SER. OUT," is for the connection of a printer, remote display or similar device. This is a 20mA passive current loop output. For more information see 'STANDARD SERIAL OUTPUT,' G•20.

---

## *Load Cell Connector*

---

Marked "LOAD CELL", Load Cell installation is explained in 'CONNECTING THE LOAD CELL' on B•5.



# Communication Attachments

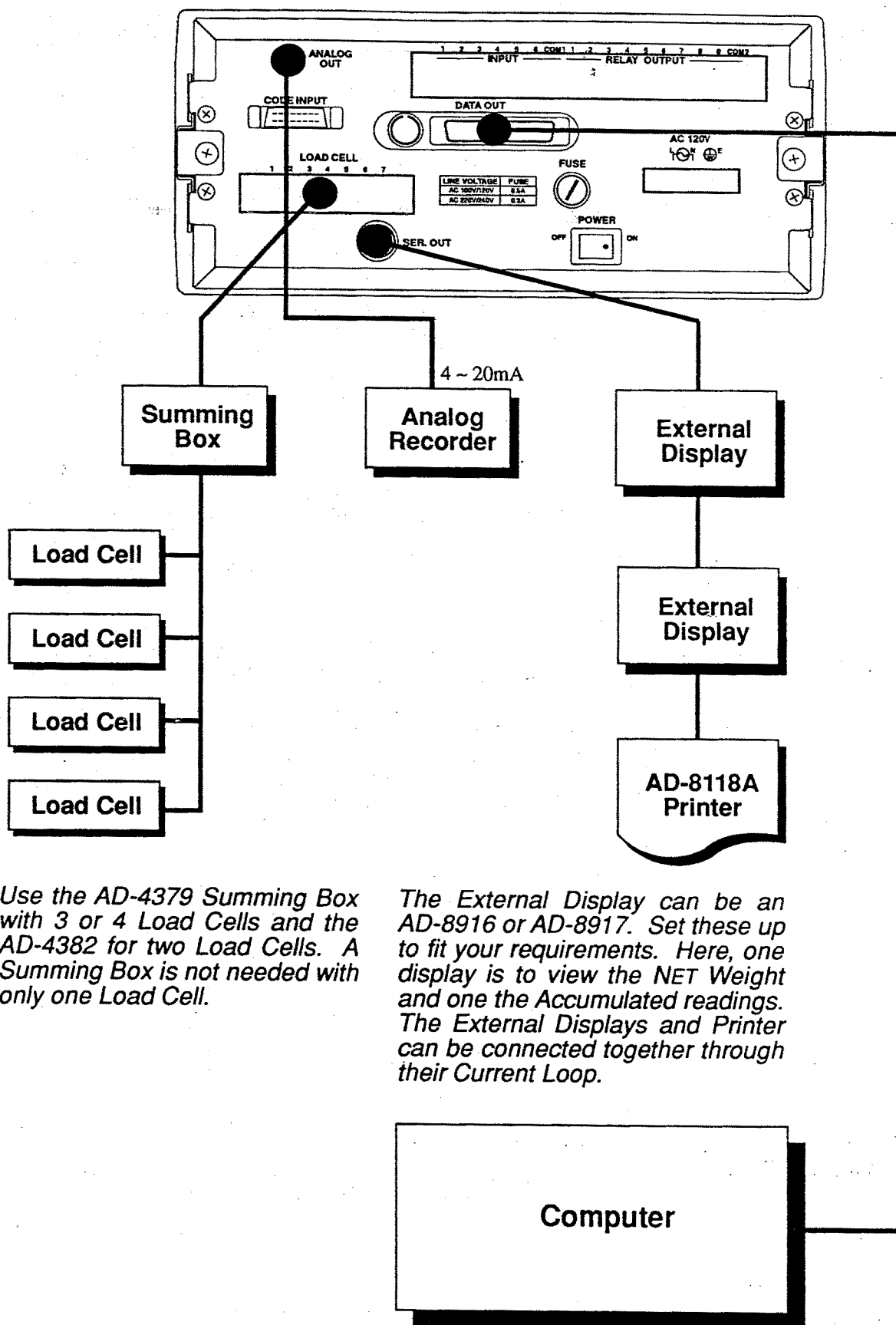

Use the AD-4379 Summing Box with 3 or 4 Load Cells and the AD-4382 for two Load Cells. A Summing Box is not needed with only one Load Cell.

The External Display can be an AD-8916 or AD-8917. Set these up to fit your requirements. Here, one display is to view the NET Weight and one the Accumulated readings. The External Displays and Printer can be connected together through their Current Loop.



# Specifications

## ANALOG INPUT AND A/D CONVERSION

Input Sensitivity	0.6 $\mu$ V/D or above
ZERO Adjustment Range	0.35mV~24mV
Max. Load Cell Input Volt.	36mV
Load Cell Excitation	12V DC $\pm$ 5% 280mA, Remote Sensing, Can be connected to up to 8 350 $\Omega$ load cells.
ZERO Temperature Comp.	$\pm$ (0.2 $\mu$ V + 0.0008% of Dead Load)/ $^{\circ}$ C TYP
Span Temperature Comp.	$\pm$ 0.0008% / $^{\circ}$ C TYP
Non-Linearity	0.01% F.S.
Input Noise	$\pm$ 0.3 $\mu$ V <sub>p-p</sub>
Input Impedance	10 M $\Omega$ or above
A/D Conversion Method	Dual slope integrating
A/D Resolution	96,000 counts maximum
A/D Conversion Rate	approx. 70 times/sec. (14m sec/conversion)

## DIGITAL SECTION

Main Display	7-segment, 7-digit cobalt-blue display, Vacuum Florescent Display screen with a 13mm character size, Displays the weight.
Display resolution	10,000 counts maximum
Set Point Displays	3 displays; one 2-digit & two 8-digit LED screen with a 10mm char. size, Set Point data, Cal & F-Funcs.
Minimum Division	by 1, x2, x5, x10, x20, x50
Maximum positive Display	"+500450"positive
Under ZERO Indicator	"-" minus sign
"ZERO" $\nabla$ Annunciator	Center of ZERO (0 $\pm$ 0.17 Divisions)
"MD" $\nabla$ Annunciator	Motion Detection
"GROSS" $\nabla$ Annunciator	GROSS Mode
"NET" $\nabla$ Annunciator	NET Mode
"TARE ENTERED" $\nabla$ Annun.	Tare has been entered
"HOLD" $\nabla$ Annunciator	Display locked
"*" $\nabla$ Annunciator	When Star key is pressed

"lb" ● Annunciator	Pounds Displayed (lb/kg version)
"kg" ● Annunciator	Kilograms Displayed
"t" ● Annunciator	Tonne Displayed (kg/ t version)
STANDBY / OPERATE KEY	Activates display and functions.
ZERO Key	ZERO's the Display when stable.
TARE Key	TARE's when stable - in NET , display ZERO
TARE CLEARED Key	TARE is cleared
NET / GROSS Key	Changes from "GROSS" to "NET" and vice versa
"*" Key	Displays Accumulated count and weight
SET POINTS RECALL KEY	Stores Set Point Code numbers
"<" Key	Moves the blinker one spot to the left.
">" Key	Moves the blinker one spot to the right.
"+" Key	Increases the number blinking by one.
"-" Key	Increases the number blinking by one.
ENTER Key	Stores data from the Set Point displays

## GENERAL

Power Requirements	100VAC, +10%,-15%, 50/60Hz, Approx 20VA
NET Weight	Approx. 4kg (8.8lb)
Operating Temperature	-5°C to 40°C (23°F to 104°F)
Maximum Humidity	85% (non-condensing)
Physical Dimensions	270(W) x 233(D) x 120(H)mm 10.63 x 9.17x 4.72 inches
Memory Battery Back-up	6 years or more without AC power (lithium)

## STANDARD ACCESSORIES

quantity

Serial Interface Connector	1
Code Input for Set Points	1
Fuse: 0.5A (for 100V→120V AC) or 0.3A (for 200V→240V AC)	1
Capacity Sticker	1
Rear Panel Protection Covers	3

## OPTIONS

<b>Option OP-01</b>	Parallel BCD (Binary-Coded-Decimal) Output (DATA OUT). Output data: weight, NET/GROSS, Motion Detection. Decimal point, lb, kg, (t), print trigger, overload:
BCD Output Connector	Quantity of 1
<b>Option OP-02</b>	Control I/O Relay Output
<b>Option OP-03</b>	Serial Interface. EIA-RS-422, with or without handshake.
Serial Interface Connector	Quantity of 2
<b>Option OP-04</b>	Serial Interface. Two types of serial interface are available with this option: 1) EIA-RS-232C, with or without handshake 2) 20mA current loop (passive) The data format of the 20 mA current loop is identical with that of the RS -232C.
Serial Interface Connector	Quantity of 1
<b>Option OP-07</b>	Analog output (4~20mA).
Analog Outlet Connector	Quantity of 1

## WEIGHT CONVERSION TABLE

One kg =	2.20462 lb(avoirdupois) approximately.
One lb =	0.453 59kg.
One t =	tonne 1,000kg (Metric Ton) or 2,204.62lb approximately
	= ton, long: (20 cwt) 2,240lb or 1,016.05kg approximately
	= ton, short: 2,000lb or 907.18kg approximately
	= ton 216 imp. gal. (ale), 252 imp. gal. (wine). "weight" = volume x density. One imp. gal. of distilled water at 62°F = 10 lb = 4.536kg, but also equals about 4.546 liters/dm <sup>3</sup> /kg at 4°C. One liter of water at 4°C equals 1kg. One US gal. is about 5/6 of an imp. gal. or about 3.785 liters.

## F-FUNCTIONS AND SETTINGS

F 01	Decimal Point Adjustment	Displays to 1,2,3 or 4 decimal places.
F 02	Weighing Unit Selection	"kg"↔"t" (Not USA ver.), "lb"↔"kg" (USA ver.)
F 03	Display Update Rate	17 times/sec., 4 times/sec.
F 04	Digital Filter	8 steps: Weak ↔ Strong
F 05	Set ZERO Range	2% or 10% of Maximum Capacity.
F 06	Motion Detection Condition	0.5 sec., 1 count → 1 sec., 9 counts

<b>F 07</b>	Auto. ZERO Track. Comp.	1 sec., 0.5 division → 2 sec., 4.5 division
<b>F 09</b>	Comparison Result Output	Normal , Locked w/ Display, or Clear Total

## FOR BATCH WEIGHING

<b>F 10</b>	Pulse Width of FINISH signal	0.0 sec. → 2.0 sec.
<b>F 11</b>	ZERO Band	Selectable (enter weight)
<b>F 12</b>	Optional Preliminary Weight	Selectable (enter weight)
<b>F 13</b>	Timer - Comparator Inhibiter	0.1 to 2.0 seconds or Disable
<b>F 14</b>	Automatic Free Fall Comp.	Set Weight or Disable
<b>F 15</b>	Weighing Mode	Select from four Batch Modes, Select whether input is from Front Panel, BCD, RS-422 or RS-232C.
<b>F 16</b>	TARE & ZERO keys Availability	Stable or Always Working (Not USA version)
<b>F 17</b>	TARE key Availability	Avail., N. A. at Minus Gross (Not USA version)
<b>F 18</b>	Timer - Finish Signal	Set between 0.1 sec. and 9.9 sec.
<b>F 19</b>	Batching Mode	Normal/Accumulation

## FRONT PANEL KEYS

<b>F 20</b>	Panel Key Disabling	Enable/Disable Selection
-------------	---------------------	--------------------------

## FOR STANDARD CURRENT LOOP

<b>F 21</b>	Baud Rate	600, 2400 Baud
<b>F 22</b>	Output Data	Display, GROSS, NET, TARE, or GROSS+NET+TARE Data
<b>F 23</b>	Output Mode	Stream, Auto Print, Manual Print, Accum. Print
<b>F 24</b>	Output Availability	Always available or when stable only
<b>F 25</b>	Output Format	Sending with code, Sending w/o code
<b>F 26 → 30</b>	N. A.	

## FOR BCD OPTION OP-01

<b>F 31</b>	Output Data	Display, GROSS, NET, or TARE Data
<b>F 32</b>	Output Mode	Stream, Auto Print, Manual Print, Accum. Print
<b>F 33</b>	Output Logic	Positive Logic, Negative Logic
<b>F 34</b>	Output Format	Normal, for AD-8113B, for AD-8114
<b>F 35 → 40</b>	N. A.	



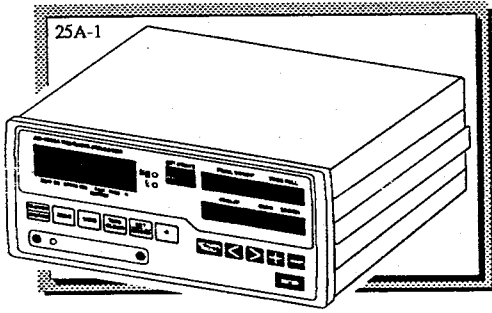

# AD-4325A • Section B

# Installation



# Unpacking & Setting Up



*Unpack the weighing indicator carefully and keep the packing material if you are likely to transport the scale again in the future.*

***Do not plug in your power cable until you have completely set up everything else!***

**1**

When you receive your AD-4325A Weighing Indicator the following should be included in the packaging:

- The Weighing Indicator.
- A Fuse (0.5A).
- Three Rear Panel Protective Covers.
- A Capacity Sticker.
- This Manual.

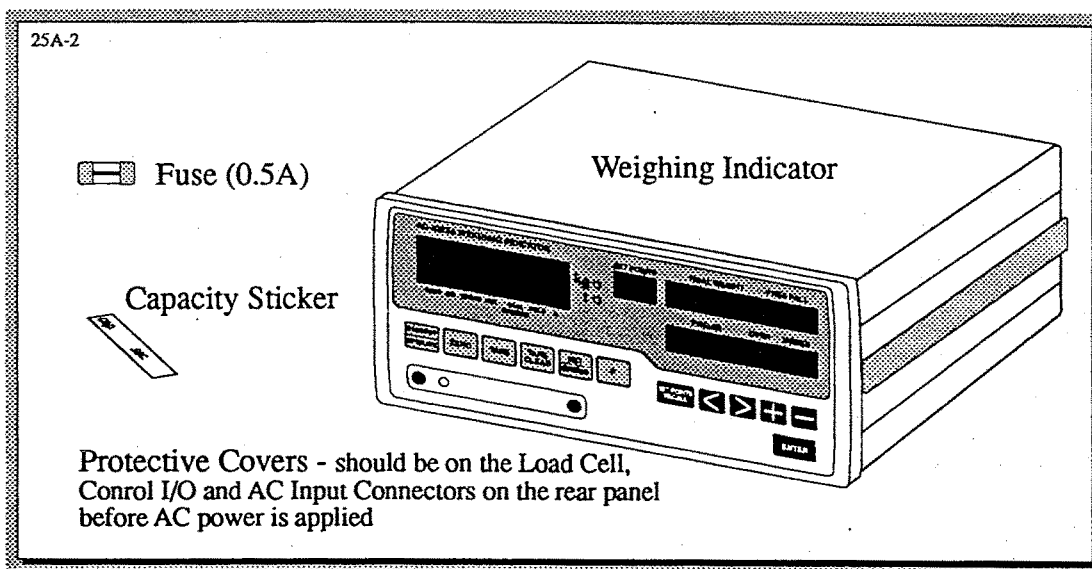

**2**

Stick the Capacity Sticker on the bottom of the Front Panel. Remember to mark down your Weighing Indicator's Maximum Capacity and Minimum Division in the space provided after calibrating (see 'FULL CALIBRATION PROCEDURE', C•5). Also, mark the AD-4325A's section weight in the space provided.

You should number your AD-4325A as well, especially if you have more than one weighing indicator. This information will help distinguish between machines.

**3**

Connect the AD-4325A to the Weighing Device Load Cell(s) via the back panel Load Cell connector. See 'CONNECTING THE LOAD CELL' on B•5. Install any other connections at this time as well: optional attachments, Control Inputs and Outputs, or an A&D printer or display. Install all protective covers.

**4** Connect a Grounding wire to the AC input screw lettered "E" as shown below. The grounding wire should be attached to earth ground. If your power cable is a three-wired cable see below.

**5** Now, attach the two wires of your power cable to the AC input screws marked "L" and "N". Your power cable should look something like the drawing below. It does not matter which wire is attached to "L" and which is attached to "N". If you have a three wire cable, the green wire is normally ground. This should be attached to the input screw marked "E". If you have any doubt as to which wire is ground, a continuity check is recommended. After attaching all three wires install the protective cover and plug the power cable into the power source. **This should be done last!** No Power cable is included with your AD-4325A due to various methods of installation to a control board. Be sure to have a

working understanding of your control panel before attaching your Power cable.

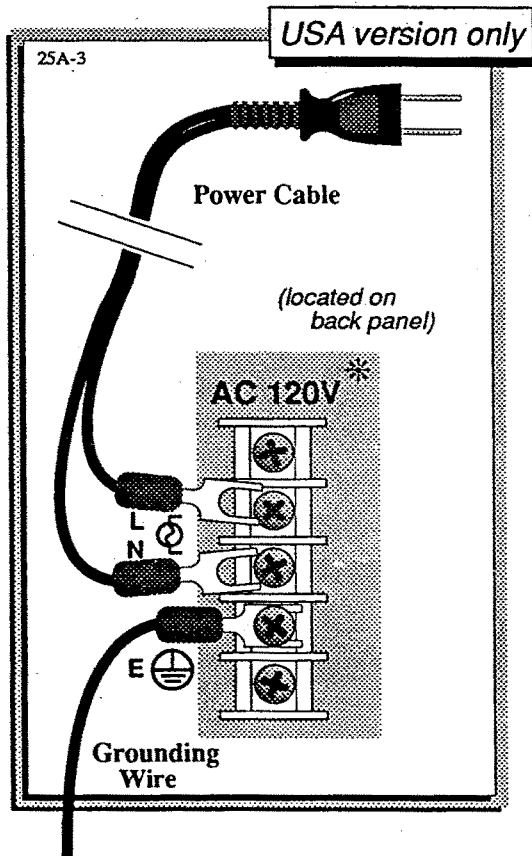

\* The drawing to the left has a voltage of 120V AC, which is the standard AC input in the US. This number will vary depending on the country in which purchased.

**6** Run a Systems Check to see if there were any errors in installation. See 'SYSTEM CHECK PROCEDURE', E-2.

**7** Connect a Grounding wire to your Weighing Hopper. Many of the substances you weigh may be statically charged.



Be sure to disconnect the plug before connecting or disconnecting anything from the rear panel.



## Best Conditions for Use



*To ensure that you get the most from your weighing indicator, please try to meet the following conditions as closely as possible:*

- Don't install in direct sunshine. Avoid sudden temperature changes, vibration, wind, water, or excessive dirt.
- The operating temperature range is from about -5°C/23°F to 40°C/104°F. The best temperature is at about 20°C/68°F with 50% Relative Humidity.
- Analogue input/output signals are sensitive to electrical noise. Do not place the cables together as this may result in electrical interference. Please also keep them well away from AC power cables. Keep all cable/coax as short as possible.
- If the local AC electricity supply fluctuates by more than  $\pm 10\%$ , an AC regulator must be used to stabilize the power supply.

# ⚠ Connecting the Load Cell



- ❑ To connect your load cell to the Weighing Indicator use a six-wire cable with shield - connect the wires as indicated below. If the AD-4325A is located near the Load Cells (within five meters or a few yards) you may use a 4-wire cable with shield, but first connect screws 1 & 2 and 3 & 4 with jumpers.
- ❑ The analogue output from the Load Cell and the RS-232C/422 input/output signals are sensitive to electrical noise. Do not place these cables together as it may result in electrical interference between the cables. Please also keep them well away from AC power cables.
- ❑ If you need more than one Load Cell you will need to install a Summing Box. A Summing Box adjusts the gain for each Load Cell and sends the signal to the Weighing Indicator. See 'COMMUNICATION ATTACHMENTS', A•11, for more information.

For two Load Cells use the AD-4382 Summing Box and for three or four Load Cells use the AD-4379. The AD-4380 Junction Box is available as well – the Junction Box extends the Load Cell cables to reach your AD-4325A.

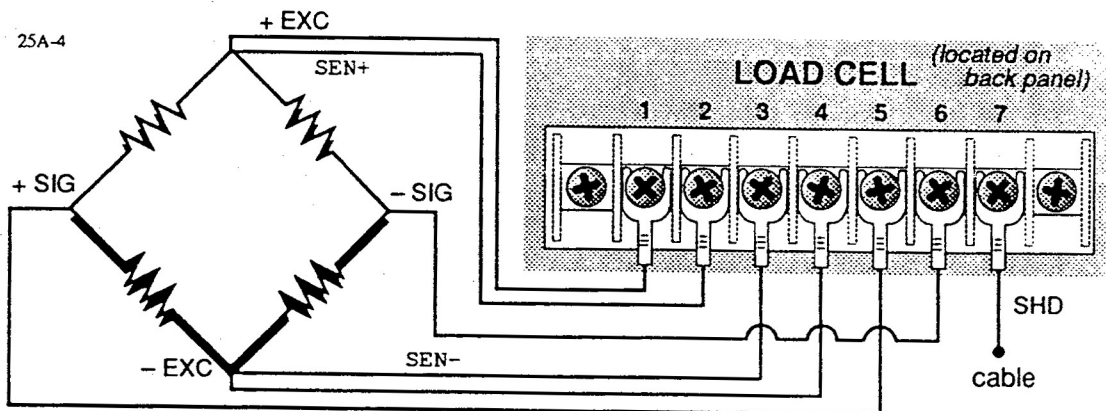

Load Cell Connections			
Screw	Signal	Screw	Signal
1	Positive Excitation Voltage (EXC+)	5	Positive Signal Voltage (SIG+)
2	Positive Sense Voltage (SEN+)	6	Negative Signal Voltage (SIG-)
3	Negative Sense Voltage (SEN-)	7	Shield (SHD)
4	Negative Excitation Voltage (EXC-)		



## Load Cell and Input Sensitivity

The relationship between the Load Cell and the Input Sensitivity ( $X$ ) of the AD-4325A is formulated below:

Load Cell Capacity	"A"	<i>Example:</i>	"A"	=	100kg
Rated Output	"B"		"B"	=	3mV/V
Max. Capacity of Platform	"C"		"C"	=	50kg
Min. Division of Display	"d"		"d"	=	0.01kg
Excitation	"EXC"		"EXC"	=	12V

- Using the above terms and numbers – the following equation can be solved:

$$"X" = "a" * "EXC" * "B" * 1,000 * ("d"/"C") \mu V$$

- " $a$ ", the actual Load Cell Range, is " $C$ "/" $A$ ". If you are using multiple load cells, the sum of all load cell ratings equals " $A$ ", and if your load cell has levers determine " $a$ " according to the lever ratio.
- Using the above equation, Input Sensitivity ( $X$ ) equals  $3.6\mu V$ . System design will be satisfactory if " $X$ " is between  $0.6\mu V$  and  $36\mu V$ .

## Quick Install



*This section is for those users who wish to simply get the AD-4325A up and working for simple use or testing. If you are going to be using the AD-4325A in a more complicated system, or unusual environment, it would be better to study the references before installation or testing. If you are unfamiliar with any of the terms below, you will find explanations in the 'CALIBRATION TERMS' section on C•2.*



*If you wish to change one of the sections below, please use the instructions in the 'FULL CALIBRATION PROCEDURE' on C•5.*

*This section is intended for initial installation and Re-install.*

## Unpack the AD-4325A

Remove the AD-4325A unit from its packaging – please check that all items on the packing list are included. See B•2.

## Connect the Load Cell(s)

Connect the AD-4325A to the Weighing Device Load Cell(s) via the back panel Load Cell connector. See 'CONNECTING THE LOAD CELL' on B•5.

## Connect Power

Connect the AD-4325A to a power source, making sure that the unit is grounded correctly. Please see 'UNPACKING AND SETTING UP', steps 5 and 6 on B•3.

## Set Minimum Division For reference, please see C•6

1

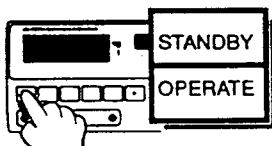

- ▶ Press the **STNDOPR** key to turn the display ON - have nothing on the weighing surface.

2

- ▶ Open the Dip-Switch cover on the front panel of the AD-4325A unit by unscrewing the knobs counter-clockwise to expose the Dip-Switches. See C•5 for diagram.

**3**

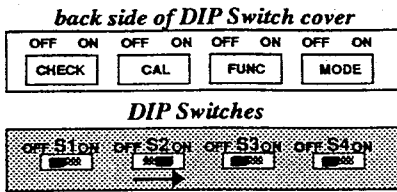

- ▶ Slide the second Dip-Switch marked "S2", ON.
- "[CAL]" will appear on the Main display, and remain on throughout Calibration.

AD-4325A WEIGHING INDICATOR



- "d" will appear on the top Set Point display. This indicates that you are setting the internal Minimum Division.
- "01" will be flashing on the lower display. This is the current Minimum Division setting.

FINAL WEIGHT FREE FALL



PRELIM OVER UNDER

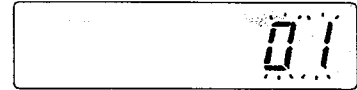

**4**

- ▶ Use the  $\boxed{+}$  and  $\boxed{-}$  keys to move through the available divisions. Please refer to 'CALIBRATION KEY ENTERING', C-7. Do not use the  $\boxed{<}$  or  $\boxed{>}$  keys.
- ▶ You are limited to one of the following internal Minimum Divisions: 1, 2, 5, 10, 20, or 50 - see 'DISPLAY RESOLUTION TABLE', B-10.

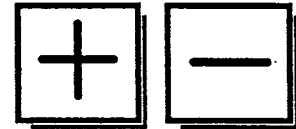

Please see 'FRONT PANEL DESCRIPTION', A-5 and 'CALIBRATION KEY ENTERING', C-7 for key descriptions.

**5**

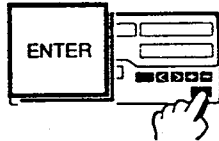

- ▶ When you have selected the Minimum Division, press the  $\boxed{\text{ENTER}}$  key.

**Set Maximum Capacity** For reference, please see C-6

- After you press  $\boxed{\text{ENTER}}$ , "[CAP]" will appear on the top Set Point display.
- The lower display reads "[0 10000]". This is the Maximum Capacity weight (10,000 lb, or kg) that is presently entered. The last digit will be flashing.

FINAL WEIGHT FREE FALL

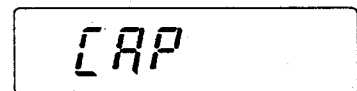

PRELIM OVER UNDER

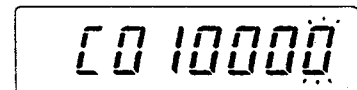

**6**

- ▶ Change the Maximum Capacity by using the keys described in the 'CALIBRATION KEY ENTERING' table on C-7.

**7**

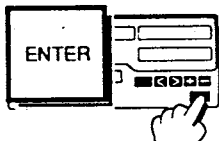

- ▶ After you have changed the Maximum Capacity, press the  $\boxed{\text{ENTER}}$  key.



**ZERO Calibration** For reference, please see C•10

- After you press **ENTER**, "PERL 0" will appear on the top Set Point display.
- The lower display will only have a period that will be blinking.

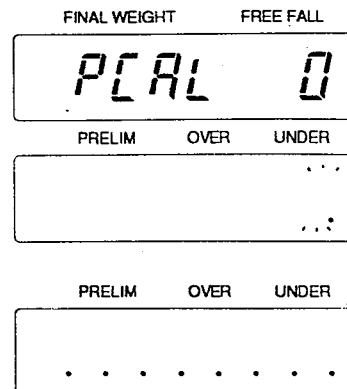

**8**

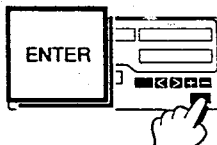

- ▶ Press **ENTER** again and a series of periods will appear for a couple of seconds across the lower Set Point display. The final period will flash during this time.

**SPAN Calibration** For reference, please see C•10

- After pressing **ENTER** - "CAL SPn" (SPAN Calibration) will appear on the top Set Point display.
- The lower display will read what ever you entered as a Maximum Capacity weight in Step 6. The last digit will be flashing.

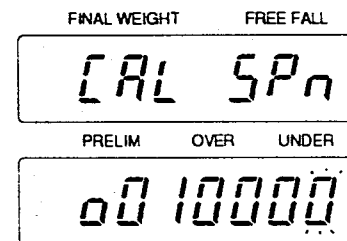

**9**

- ▶ If you are not using the Maximum Capacity as your SPAN weight, or if the exact weight of the Calibration Mass is known – please enter in the weight of the calibration mass by using the keys described in the 'CALIBRATION KEY ENTERING' table on page C•7.

**10**

- ▶ Place the calibration mass on the weighing device you are using.

**11**

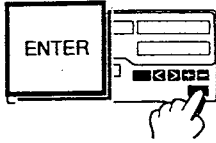

▶ Press the **ENTER** key after you have entered the SPAN weight or placed the calibration mass. A series of periods will appear across the lower Set point display. The final period will flash during this time, followed by:

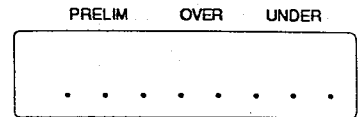

- "CAL 0" will appear on the top Set Point display.
- The lower display will have a period that will be blinking.

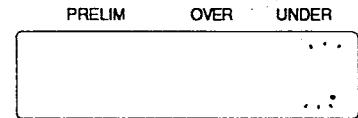
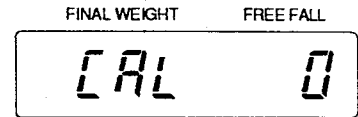

**12**

▶ Remove the calibration mass from the weighing device if you were using one.

**13**

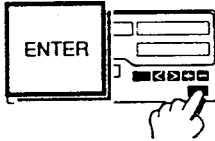

▶ Press **ENTER** once again. A series of periods will appear across the lower Set Point display. The final period will flash during this time, followed by:

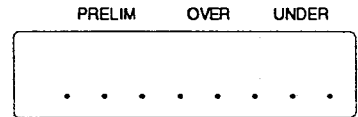

- "End" will appear on the top Set Point display indicating the end of calibration. Nothing will appear on the bottom Set Point display.

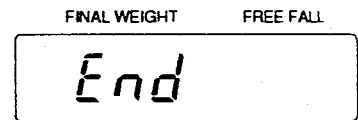

**14**

▶ Slide the second Dip-Switch, "S2", back to the OFF position.

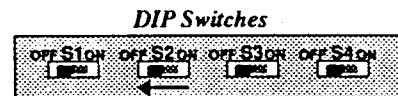
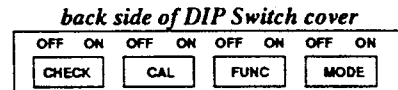

**15**

▶ Return the Dip-Switch cover to the front panel by screwing the knobs clockwise.



## Setting the Decimal Place

To set the decimal place – please follow the example in the 'CHANGING THE F-FUNCTIONS' procedure, **F•3**.



## Problems

If you have any problems – such as an error message, please see: 'CALIBRATION ERRORS', (**C•13**), 'CALIBRATION TERMS', (**C•2**) and the 'FULL CALIBRATION PROCEDURE', (**C•5**). Please see 'THE F-FUNCTION SETTINGS', beginning on **F•8**, for specific F-Function settings.

# Display Resolution Table

Maximum Capacity	RESOLUTION					
	1 Min. Div.	2 Min. Div.	5 Min. Div.	10 Min. Div.	20 Min. Div.	50 Min. Div.
300	1/300					
400	1/400					
500	1/500					
600	1/600	1/300				
800	1/800	1/400				
1,000	1/1,000	1/500				
1,200	1/1,200	1/600				
1,500	1/1,500	1/750	1/300			
2,000	1/2,000	1/1,000	1/400			
2,500	1/2,500	1/1,250	1/500			
3,000	1/3,000	1/1,500	1/600	1/300		
4,000	1/4,000	1/2,000	1/800	1/400		
5,000	1/5,000	1/2,500	1/1,000	1/500		
6,000	1/6,000	1/3,000	1/1,200	1/600	1/300	
8,000	1/8,000	1/4,000	1/1,600	1/800	1/400	
10,000	1/10,000	1/5,000	1/2,000	1/1,000	1/500	
12,000		1/6,000	1/2,400	1/1,200	1/600	
15,000		1/7,500	1/3,000	1/1,500	1/750	1/300
20,000		1/10,000	1/4,000	1/2,000	1/1,000	1/400
25,000			1/5,000	1/2,500	1/1,250	1/500
30,000			1/6,000	1/3,000	1/1,500	1/600
40,000			1/8,000	1/4,000	1/2,000	1/800
50,000			1/10,000	1/5,000	1/2,500	1/1,000
60,000				1/6,000	1/3,000	1/1,200
80,000				1/8,000	1/4,000	1/1,600
100,000				1/10,000	1/5,000	1/2,000
120,000					1/6,000	1/2,400
150,000					1/7,500	1/3,000
200,000					1/10,000	1/4,000
250,000						1/5,000
300,000						1/6,000
400,000						1/8,000
500,000						1/10,000

○ When the minimum division is set to 10, 20 or 50 - the main display will use all 6 digits.

# Re-Installation

## For F-Function, Calibration, Set Point and Accumulated Count and Value Re-initialization



Re-Install resets the AD-4325A to the initial factory settings. Use Re-Install if you want to return **ALL** F-Functions to their initial settings. You may also choose to clear all Calibration, Set Point and Accumulated Count and Accumulated Value settings as well.



The Calibration settings can **NOT** be cleared without first clearing the F-Function code settings. See 'FULL CALIBRATION PROCEDURE', C-5, if you only want to change the Calibration settings.

## Re-Installing Procedure

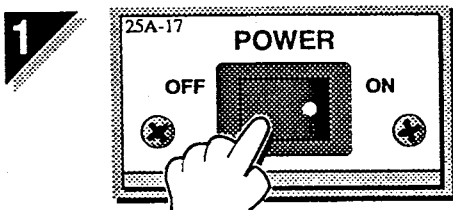

- ▶ Turn the power OFF on the Rear Panel.
- Check to see that Dip-Switch "S4" is slid to the OFF position.



- ▶ Press both the **ZERO** key and the **TARE CLR** key and **HOLD** them in.



- ▶ While still holding in the **ZERO** and **TARE CLR** key – power ON from the Rear Panel.

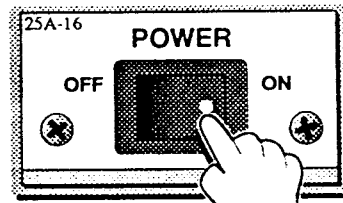

AD-4325A WEIGHING INDICATOR

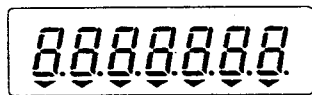

SET POINTS

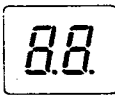

FINAL WEIGHT

FREE FALL

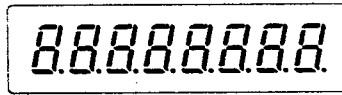

PRELIM OVER UNDER

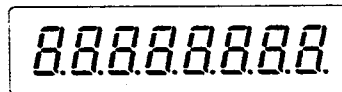

- "8.8.8.8.8.8.8.8." will appear on all four displays for a couple of seconds.



Once you re-initialize the F-Functions and/or the Calibration, Set Point and Accumulated Count and Value settings – you can **NOT** recall any of that information. Read steps 4 through 8 before proceeding.

4

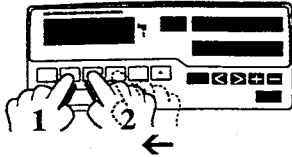

▶ While the four displays show "88888888" – release the **TARE CLR** key – slide finger #2 over one key to the left – and press the **TARE** key. You will now be holding in both the **ZERO** and **TARE** keys.

○ "in it" will appear on the Main display, and

AD-4325A WEIGHING INDICATOR

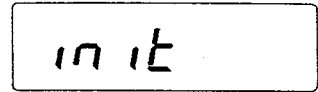

○ a series of periods will appear across the top Set Point display with the last period flashing.

FINAL WEIGHT FREE FALL

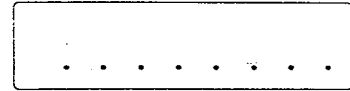

5

You are currently re-initializing all the F-Function settings – you now have a choice:

▶ If you want to clear the Calibration, Set Point and Accumulated Count and Accumulated Value settings – go to step #6.

○ If you don't want to clear all of these, then do nothing – "End" will appear on the top Set Point display for a couple of seconds – Re-install is completed and the display will return to normal mode.

FINAL WEIGHT FREE FALL

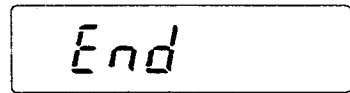

6

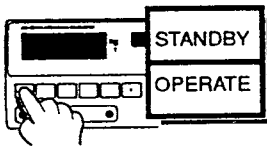

▶ Remove both fingers from the **ZERO** and **TARE** keys – and press the **STND/OPR** key while the series of periods are **still blinking** on the top Set Point display.

○ "in itALL" will appear on the Main display, and

FINAL WEIGHT FREE FALL

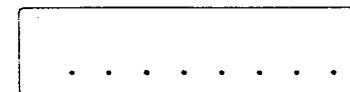

AD-4325A WEIGHING INDICATOR

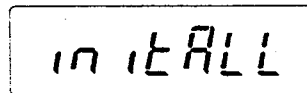

FINAL WEIGHT FREE FALL



7

You are now clearing Calibration, Set Point and Accumulated Count and Value settings – they will be reset to their initial settings.

○ "End" will appear on the top Set Point display for a couple of seconds – and then will return to normal mode.

FINAL WEIGHT FREE FALL

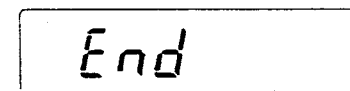

8

If you used step #6 and reset Calibration, you will have to Calibrate the AD-4325A before beginning operation – go to either 'QUICK INSTALL', B•7, or 'FULL CALIBRATION PROCEDURE', C•5.

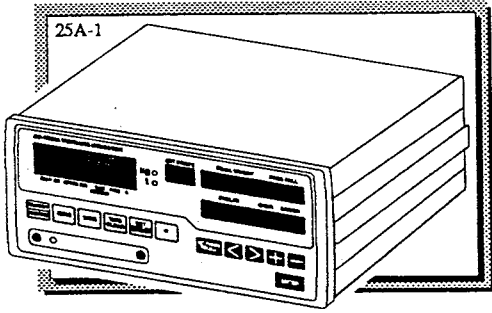

## AD-4325A • Section C

# Calibration



## Calibration Terms

The section "FULL CALIBRATION PROCEDURE", starting on **C-5**, describes the steps needed to make the AD-4325A functional as a weighing indicator. The terms used in the procedure are defined below.

### *Minimum Division*

The Display Resolution depends on, and is limited by, the Minimum Division. Display resolution is calculated by dividing Minimum Division by Maximum Capacity. (see the 'DISPLAY RESOLUTION TABLE', **B-12**). The Minimum Division's are the blocks in which the display will be able to show change in weight. If you set the AD-4325A for 1 Minimum Division, then the display will be able to move by one, ex: 101, 102, 103... If you set it for 2 Minimum Divisions, then the smallest the display will be able to move is by two's, ex: 100, 102, 104.... and so forth. You are limited to 1, 2, 5, 10, 20, or 50 Minimum Divisions – this is in turn limited by the Maximum Capacity of your weighing device.

### *Zero Calibration*

ZERO calibration is simply calibrating the AD-4325A to the weighing device when it has no weight acting on it. This gives the Weighing Indicator a base reference point, "ZERO", to compare with when weight is added. It is possible that temperature changes, wear-and-tear on the Weighing Indicator, and other influences, may cause the "ZERO" point to drift - thus needing re-calibration. You may want to do ZERO Calibration on a regular schedule, as weighing conditions demand.

### *Maximum Capacity*

The Maximum Capacity is the full weight that you want your weighing device to handle. This could be the rated capacity of the Load Cells, or some other limit you wish to set. Maximum Capacity also has a relationship to the Display Resolution. Display resolution is calculated by dividing Minimum Division by Maximum Capacity. Please see the 'DISPLAY RESOLUTION TABLE' on **B-12**.



## *Span Calibration*

SPAN calibration is simply calibrating the AD-4325A to the weighing device at, or near, full capacity. With ZERO Calibration, you set an empty weighing device as your "ZERO" point. With SPAN Calibration, you set the end point of your weighing device's ability to weigh - its Maximum Capacity. This gives the AD-4325A two extreme points in which it knows the correct weight. Now it will accurately calculate what the weights are in between. While the most accurate SPAN Calibration is with Maximum Capacity as your SPAN weight - this may not always be possible. In those cases, use the weight closest to Maximum Capacity that is practical.



The closer to Maximum Capacity the SPAN weight is - the more accurate the reading will be (especially at the higher end).



### **If You Want to Perform...**

#### *ZERO Calibration ONLY*

If you only want to perform the simple calibration procedure - use the 'ZERO CAL & FINE SPAN' procedure, C-10.

#### *Minimum Division Change ONLY*

If you only want to change the Minimum Division - use the 'FULL CALIBRATION PROCEDURE' (C-5), after Step 4, press the **ENTER** key, and slide the Calibration Dip-Switch, "S2" OFF.

#### *Maximum Capacity Change ONLY*

If you only want to change the maximum capacity - use the 'FULL CALIBRATION PROCEDURE' (C-5), after Step 7, press the **ENTER** key, and slide the Calibration Dip-Switch, "S2" OFF.

#### *SPAN Calibration ONLY*

If you only want to do SPAN Calibration - use the 'ZERO CAL & FINE SPAN' procedure, C-10.

#### *Any Mix of Changes*

If you only want to make some other mix of changes or calibrations, please go through the procedure from the beginning and make your choices as you move through.

# Calibration Flowchart

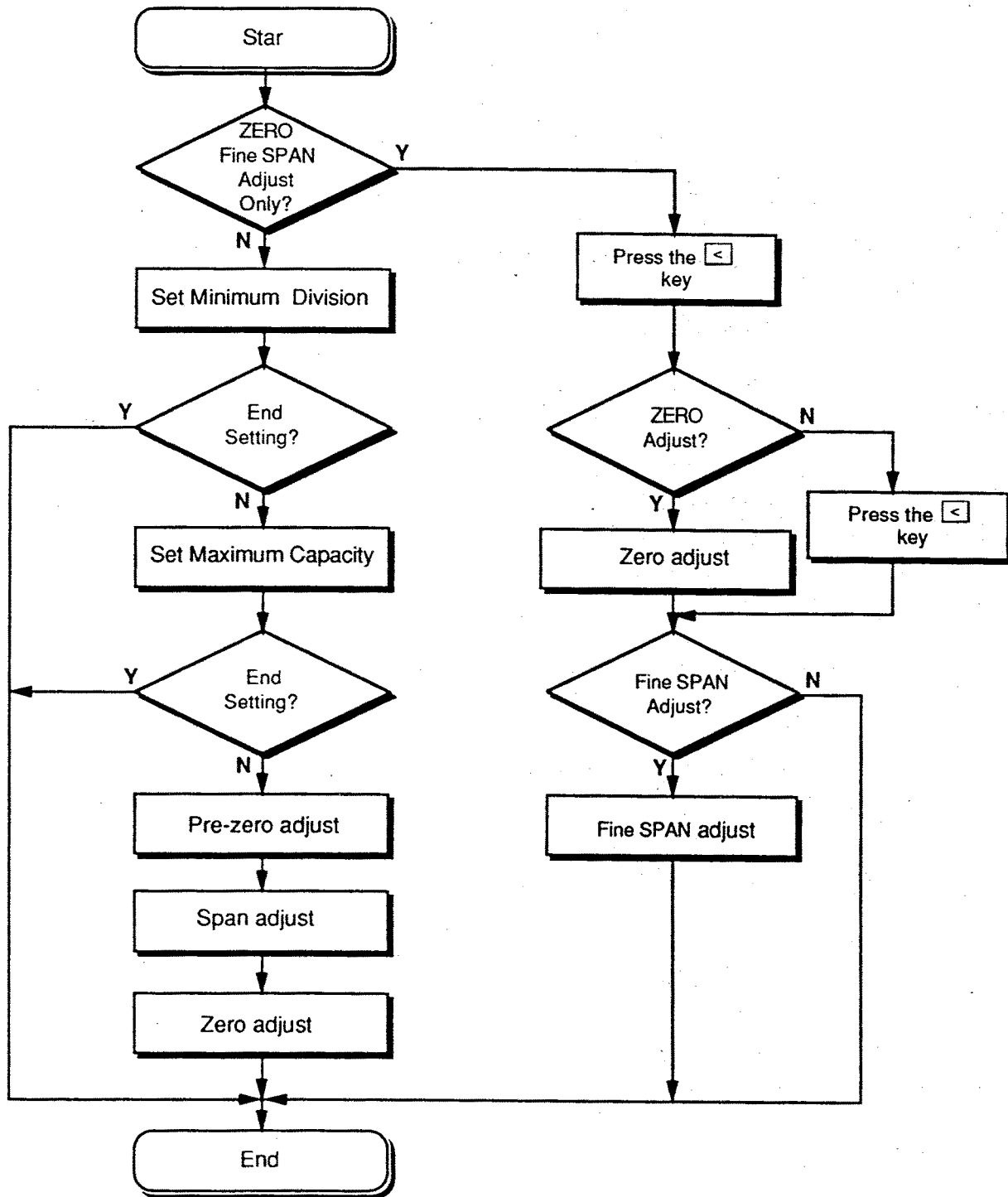

# Full Calibration Procedure

## *For Initial Calibration, Minimum Division and Maximum Capacity Changes*



Your AD-4325A should be calibrated: when first installed, if moved, after Re-installation and on a regular basis as conditions warrant. Calibration is part of regular operations, correcting changes in temperature, humidity, air pressure, etc.



The AD-4325A must be warmed up (plugged in) for at least 30 minutes before starting calibration.

During calibration, the weighing system must be kept stable for accurate adjustment.

*The display examples shown in this procedure are initial ones. After this procedure has been done once, the example numbers may be different than the actual numbers displayed on your indicator.*

**1**

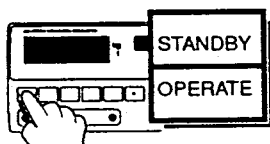

- ▶ Press the **STND/OPR** key to turn the display ON – have nothing on the weighing surface.

**2**

- ▶ Open the Dip-Switch cover on the front panel of the AD-4325A unit by unscrewing the knobs counter-clockwise to expose the Dip-switches.

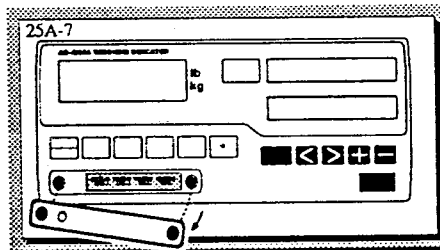

3

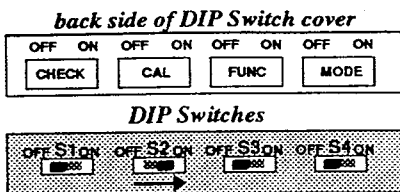

- ▶ Slide the second Dip-Switch marked "S2", ON.
- "[CAL]" will appear on the Main display, and remain on throughout Calibration.

AD-4325A WEIGHING INDICATOR

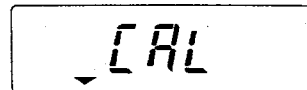

- "d" will appear on the top Set Point display. This indicates that you are setting the internal Minimum Division.
- "01" will be flashing on the lower Set Point display. This is the current Minimum Division setting.

FINAL WEIGHT FREE FALL

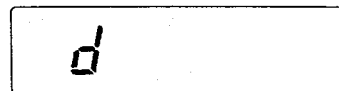

PRELIM OVER UNDER

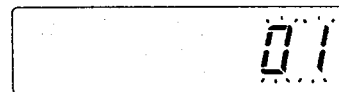

The ▼MD (MD Annunciator) will disappear after you press **ENTER** for a few seconds before re-appearing throughout calibration. Wait until it reappears before moving on to the next step.

4

- ▶ If you do not want to change the Minimum Division go on to Step 5.
- ▶ If you want to change the Minimum Division, use the **+** and **-** keys to move through the available divisions. **Do not use** the **<** or **>** keys unless you want to go straight to 'ZERO CAL & FINE SPAN', C-10.
- ▶ You are limited to one of the following internal Minimum Divisions: 1, 2, 5, 10, 20, or 50 - see the 'DISPLAY RESOLUTION TABLE', B-12.

Minimum Division



*Please see the 'FRONT PANEL DESCRIPTION', A-3 and 'CALIBRATION KEY ENTERING' below, for key descriptions.*

5

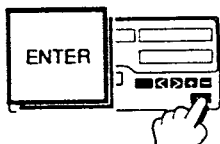

- ▶ If there is no change to the Minimum Division, or if you have already changed to the new setting, press the **ENTER** key.
- ▶ If you only wanted to change the Minimum Division go to Step 14 and finish.

Maximum Capacity

- After you press **ENTER** - "[CAP]" will appear on the top Set Point display.
- The lower display reads "[0 10000]". This is the Maximum Capacity weight (10,000 lb, kg, or t) presently entered. The last digit will be flashing.

FINAL WEIGHT FREE FALL

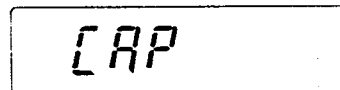



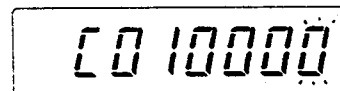



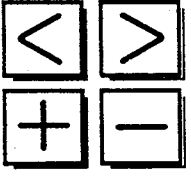

PRELIM OVER UNDER

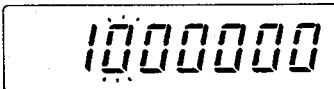

6

- ▶ If you do not want to change the Maximum Capacity, go to Step 7.
- ▶ If you wish to change the Maximum Capacity, you may do so now by using the keys as described in the 'CALIBRATION KEY ENTERING' table. Enter in the Maximum Capacity of your weighing device.

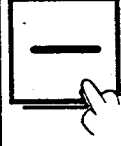
	<h2>Calibration Key Entering</h2>		
			The <b>ENTER</b> key stores settings into memory and moves to the next screen.
	<input type="radio"/> The <b>&lt;</b> key moves the flashing cursor digit to the left. <div style="text-align: center;">                       Press the <b>&lt;</b> key and ...   </div>		<input type="radio"/> The <b>+</b> key increases the flashing cursor by one digit. <div style="text-align: center;">                       Press the <b>+</b> key and ...   </div>
	<input type="radio"/> The <b>&gt;</b> key moves the flashing cursor digit to the right.		<input type="radio"/> The <b>-</b> key decreases the flashing cursor by one digit.

7

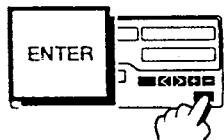

- ▶ If there is no change to the Maximum Capacity, or if you have already changed to the new setting, press the **ENTER** key.
- ▶ If you have now finished changing what you wanted - go to Step 14 and finish.

- After you press **ENTER** - "PERL 0" will appear on the top Set Point display.
- The lower display will only have a period that will be blinking.

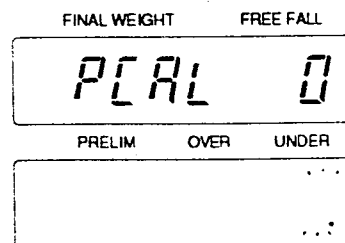

**8**

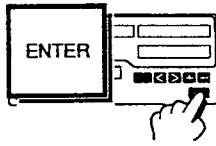

▶ Press **ENTER** again and, for a couple of seconds, a series of periods will appear across the lower Set Point display with the last period flashing, followed by:

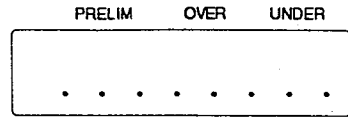

**SPAN Calibration**

- "CAL SPn" (SPAN Calibration) will appear on the top Set Point display.
- The lower display will read whatever you entered as a Maximum Capacity weight in Step 6. For example, if you didn't change anything the display will read "00 10000" (10,000 lb, kg, or t). The last digit will be flashing.

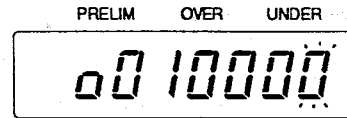
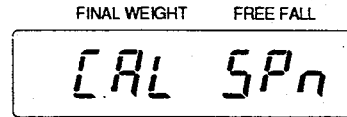

**9**

▶ If you are not using the Maximum Capacity as your SPAN weight, please enter in the weight of the calibration mass by using the keys described in the 'CALIBRATION KEY ENTERING' table on C-7.

**10**

▶ Place your calibration mass on the weighing device

**11**

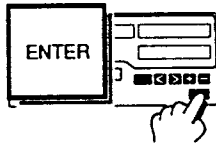

▶ Press **ENTER** after you have entered the SPAN weight and placed the calibration mass. For a couple of seconds a series of periods will appear across the lower Set Point display with the last period flashing, followed by:

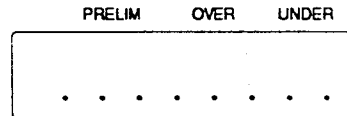

**ZERO Calibration**

- "CAL 0" will appear on the top Set Point display.
- The lower Set Point display will show a blinking period.

series of periods will appear across the lower Set Point display with the last period flashing, followed by:

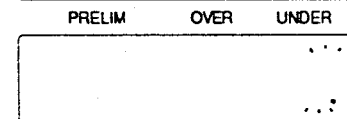
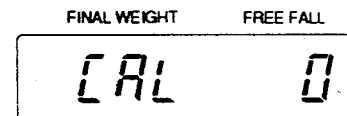

**12**

- ▶ Remove the calibration mass from the weighing device.

**13**

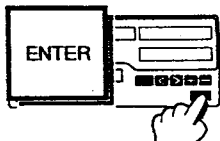

- ▶ Press **ENTER** once again. A series of periods will appear across the lower Set Point display with the last period flashing, followed by:

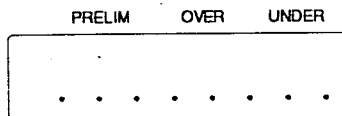

- "End" will appear on the top Set Point display indicating the end of full calibration. Nothing will appear on the bottom Set Point display.

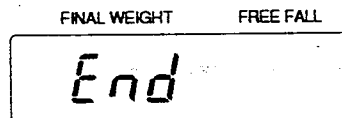

**14**

- ▶ Slide the second Dip-Switch, "S2", back to the OFF position.

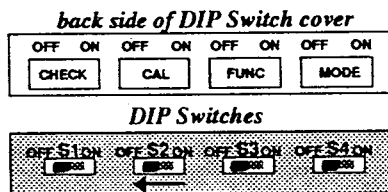

**15**

- ▶ Return the Dip-Switch cover to the front panel by screwing the knobs clockwise.

# ZERO Cal & Fine SPAN

## Periodic Calibration Adjustment of ZERO Point and Manual SPAN – to Maintain Accuracy



The display examples shown in this procedure are initial ones. After this procedure has been done once, the example numbers may be different than the actual numbers displayed on your indicator.

**1**

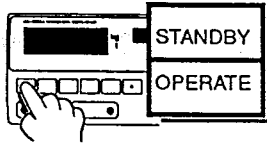

- ▶ Press the **STND/OPR** key to turn the display ON – have nothing on the weighing surface.

**2**

- ▶ Open the Dip-Switch cover on the front panel of the AD-4325A unit by unscrewing the knobs counter-clockwise to expose the Dip-Switches.

**3**

*back side of DIP Switch cover*

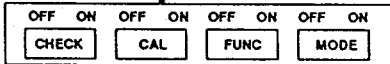

*DIP Switches*



- ▶ Slide the second Dip-Switch marked "S2", ON.

- "CAL" will appear on the Main display.

AD-4325A WEIGHING INDICATOR

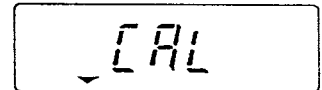

FINAL WEIGHT      FREE FALL



PRELIM      OVER      UNDER



- "d" will appear on the top Set Point display.
- "01" will be flashing on the lower Set Point display. This number will be either 1, 2, 10, 20, or 50 – depending on your Minimum Division setting.



4

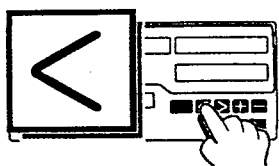

▶ Press the  $\leftarrow$  key to bypass Minimum Division, Maximum Capacity and SPAN Calibration.

**ZERO Calibration**

○ After you press  $\leftarrow$  - "CARL 0" will appear on the top Set Point display.

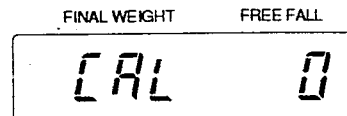

○ The lower Set Point display will only have a period that will be flashing.

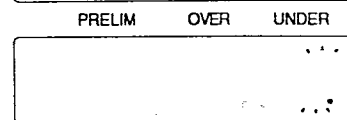

5

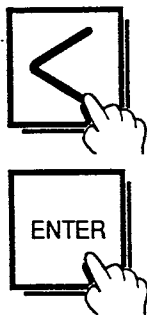

OR

▶ If you only want to perform manual SPAN adjustment then press  $\leftarrow$  to bypass ZERO Calibration.

▶ If you wish to perform Zero Calibration, remove all weight from the weighing device and press  $\leftarrow$  periods will appear across the lower Set Point display with the last period flashing.

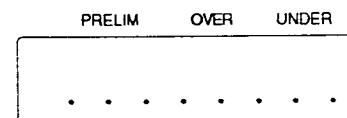

[ENTER]. A series of lower Set Point display

○ After you press [ENTER] or  $\leftarrow$  - "SPn Rdu" will appear on the top Set Point display.

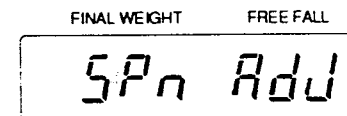

○ The lower display will read "R 0". The value "0" could be the mass on the indicator, or the weight of the system itself, acting on the load cells - it is not necessary to be accurate.

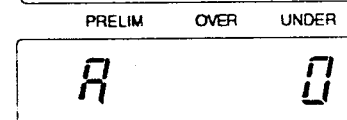

6

▶ Load the standard weight you are using on the weighing device. The display will show it's weight.

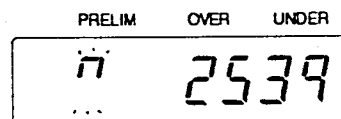

**SPAN Calibration**

▶ To perform Fine SPAN Adjustment on the standard weight please use the keys described in the 'CALIBRATION KEY ENTERING' table (C-7) - to increase or decrease the standard weight. It will take about 3 seconds per unit to adjust the standard weight.



will be shown when the  $+$  key is pressed.

will be shown when the  $-$  key is pressed.

**7**

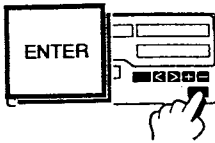

▶ Press **ENTER**

- "End" will appear on the top Set Point display. Nothing will appear on the bottom Set Point display.

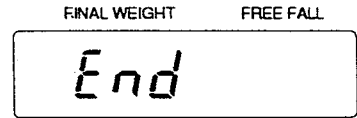

**8**

- ▶ Slide the second Dip-Switch, "S2", back to the OFF position. The display will return to normal after a few seconds.
- ▶ Return the Dip-Switch cover to the front panel by screwing the knobs clockwise.

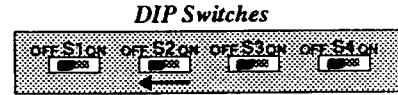
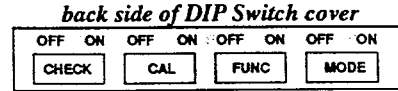



# Calibration Errors

**All Calibration Errors will appear on the lower Set Point display.**

**❑ 'C Err' Errors:**

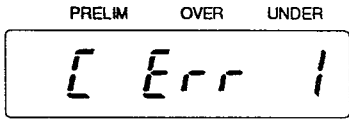

'C Err 1' will be displayed if the resolution exceeds 1: 10,000.

- ▶ Check the Minimum Division and Maximum Capacity ratio. Make sure that the resolution does not exceed 10,000 Divisions.

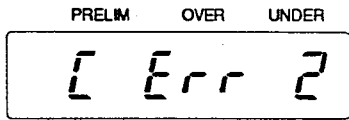

'C Err 2' will be displayed if the Load Cell output is too large at ZERO Calibration.

- ▶ In this case add an additional resistor between EXC+ and SIG-.

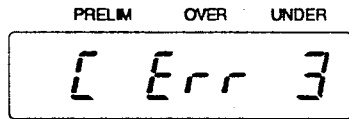
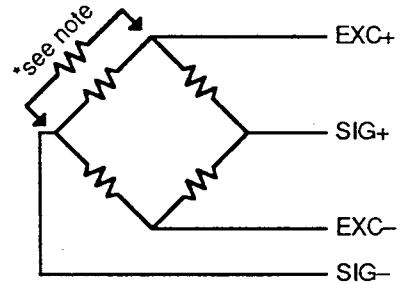

'C Err 3' will be displayed if the Load Cell output is too small (negative offset) at ZERO Calibration.

- ▶ In this case add an additional resistor between EXC+ and SIG+.

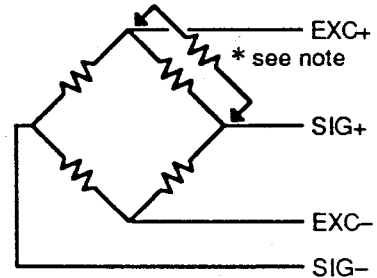

**★ note:** *The resistor should have as high a resistance as possible (50kΩ to 500kΩ) and should be of the highest quality, having the lowest temperature coefficient.*

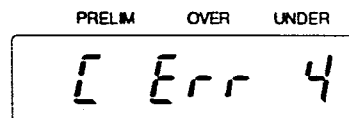

'C Err 4' will be displayed if the Calibration Mass has been mistakenly entered as a value greater than the Maximum Capacity.

- ▶ Re-enter the 'Cal SPAN' weight in Step #9 of the 'FULL CALIBRATION PROCEDURE', C-8.

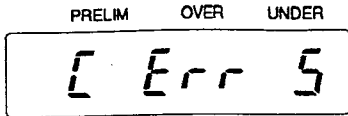

'C Err 5' will be displayed if the Calibration Mass has mistakenly been entered as "0", or if it is smaller than the Minimum Division.

- ▶ Re-enter the 'Cal SPAN' weight in Step #8 of the 'FULL CALIBRATION PROCEDURE', C-8.

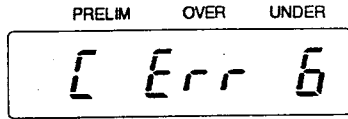

'C Err 6' will be displayed if the Load Cell output is too low.

- ▶ Replace your Load Cell with a more sensitive one, or adjust the Minimum Division and Maximum Capacity ratio from the 'DISPLAY RESOLUTION TABLE' on B-12. Make the resolution smaller.

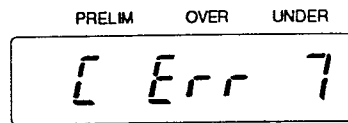

'C Err 7' will be displayed if the Load Cell signal pins are reversed, incorrectly wired, or the Load Cell output voltage at capacity weight is too low.

- ▶ Check the connection between the load cell and the AD-4325A. See 'CONNECTING THE LOAD CELL', B-5.

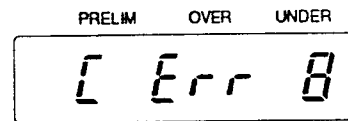

'C Err 8' will be displayed if the Load Cell output voltage at capacity weight is too high.

- ▶ Check the Input Sensitivity of the load cell. See 'LOAD CELL AND INPUT SENSITIVITY', B-14.

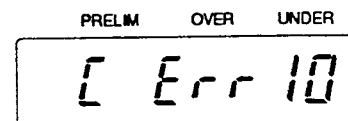

'C Err 10' will be displayed if the check dip-switch "S1" is slid on during the calibration procedure.

- ▶ Turn off switch "S1" and continue calibration.

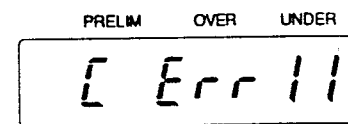

'C Err 11' will be displayed if the ZERO or TARE were not cleared during Fine SPAN Adjustment.

- ▶ Clear ZERO and/or TARE and re-start Calibration.

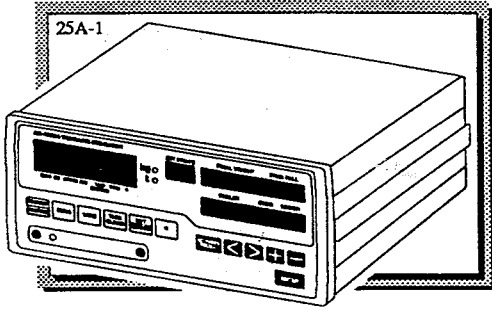

## AD-4325A • Section D

# Set Points

# About Set Point Displays



The Set Point Displays show the stored Batch Weighing data. 100 different settings can be stored under the Code settings '00 ~ 99', in the 2-digit Set Point display.

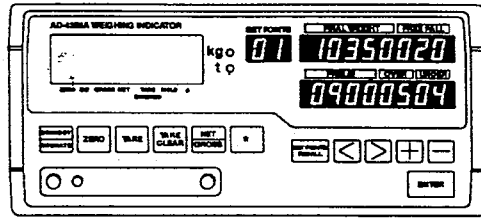

The two 8-digit displays are used to show the Batch Weighing information for each Code setting. The top, 8-digit Set Point display provides five spaces for the Final Weight and three spaces for the Free Fall value. The bottom, 8-digit Set Point display has four spaces for the Preliminary Weight and two spaces each for the Over and Under Weights. (see below)

## Set Point Code      Top Set Point Display      Bottom Set Point Display

SET POINTS

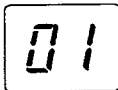

FINAL WEIGHT      FREE FALL

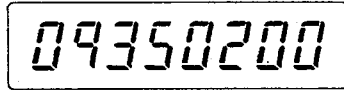

PRELIM      OVER      UNDER

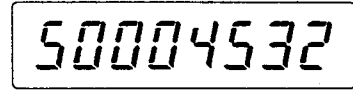

▣ 100 different Set Point Codes can be stored under the Code settings '00 ~ 99'.

▣ The top Set Point display provides five spaces for the Final Weight (marked "09350"), and three spaces for the Free Fall value (marked "200").

▣ The bottom Set Point display has four spaces for the Prelim. Weight (marked "5000") and two spaces each for the Over and Under Weight (marked "45" and "32").



The Set Point Displays work independently of the Main Display. The Main Display will continue to show the weight from the load cell(s) while you are entering Set Point Data.

# Set Point Procedure

To store Set Point Code and Values – first check your F-Function 'F 15' setting:

Weighing Mode					
F 15		RS-422, RS-232C	BCD	Front Panel	Weighing Mode
	Customer Programmed Control Mode	21	11	●01	Normal Batching
		22	12	02	Loss-in-Weight Batching
	Built-in Automatic Program Mode	23	13	03	Normal Batching
		24	14	04	Loss-in-Weight Batching
<p>When entering Set Point code from the Front Panel use the settings "01-04", depending on your Batching system. Use the settings "11-14", when using the Code Input Connector on the Rear Panel and settings "21-24", when using the RS-422 (OP-03) or RS-232C (OP-04) to enter Set Point Codes.</p>					

- ❑ If 'F 15' is set from '01 ~ 04' – all Set Point Codes and Set Point Values will be entered from the Front Panel, see 'SET POINT CODE' below.
- ❑ If 'F 15' is set from '11 ~ 14' – the Set Point Code will be entered from the Code Input Connector, see 'CODE INPUT CONNECTOR', G•23. The Set Point Values will still be entered from the Front Panel, see 'SET POINT VALUES', D•4.
- ❑ If 'F 15' is set from '21 ~ 24' – the Set Point Code and Set Point Values will also be entered from the RS-422 Interface Option (OP-03) or RS-232C Interface Option (OP-04), see 'RS-232C DATA FORMATS', H•7.

'F 15' =	Set Point Code	Set Point Values
01 ~ 04 Front Panel	Front Panel Keys	Front Panel Keys
11 ~ 14 BCD	From code input connector	Front Panel Keys
21 ~ 24 RS-422, RS-232C	From computer 'F 43' is also set to "5"	Front Panel Keys or from computer, 'F 43' is also set to "5"

## ⚡ Set Point Code

*When 'F 15' = '01 ~ 04' Only*

- ❑ *The displays shown in this procedure are examples only. The example numbers will be different than the actual numbers displayed.*

1

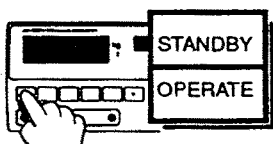

- ▶ Press the **STND/OPR** key to turn the display ON - have nothing on the weighing surface.

2

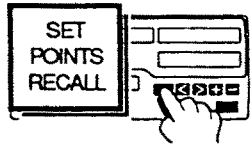

- ▶ Press the **S.P.R.** key to enter 'Set Point mode'.
- One of the two digits in the 2-digit display will be flashing – "00".

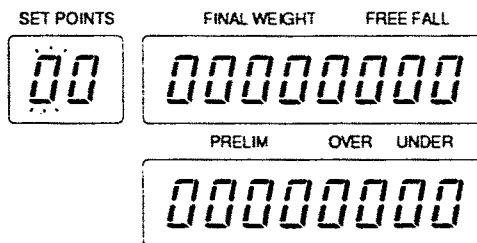

3

- ▶ Use the **←**, **→**, **+** and **-** keys to change the Set Point Code number (see 'SET POINT KEY ENTERING', D•4), you will **NOT** be able to move out of the 2-digit display. (We will set the Code to '01' in this example)

## Set Point Key Entering

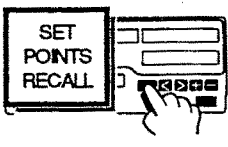
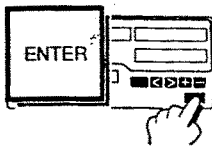
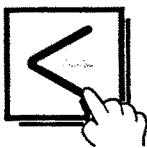
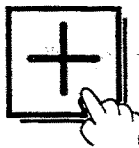
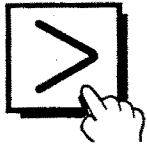
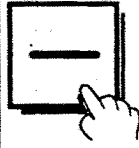
 <p>The <b>[S.P.R.]</b> key serves two functions. First, it calls up Set Point Code settings. Second, it serves as an escape key.</p>	 <p>The <b>[ENTER]</b> key stores Set Point Code settings and Values into memory.</p>
 <p><input type="radio"/> The <b>[←]</b> key moves the flashing cursor digit to the left.</p> <div style="border: 1px solid black; padding: 5px; text-align: center; font-family: monospace; font-size: 1.2em;">09350200</div> <p>Press the <b>[←]</b> key and ...</p> <div style="border: 1px solid black; padding: 5px; text-align: center; font-family: monospace; font-size: 1.2em;">09350200</div>	 <p><input type="radio"/> The <b>[+]</b> key increases the flashing cursor by one digit.</p> <div style="border: 1px solid black; padding: 5px; text-align: center; font-family: monospace; font-size: 1.2em;">50004432</div> <p>Press the <b>[+]</b> key and ...</p> <div style="border: 1px solid black; padding: 5px; text-align: center; font-family: monospace; font-size: 1.2em;">50004532</div>
 <p><input type="radio"/> The <b>[→]</b> key moves the flashing cursor digit to the right.</p> <p><b>NOTE:</b> The <b>[←]</b> and <b>[→]</b> keys can't be used to "jump" screens after pressing the <b>[S.P.R.]</b> key.</p>	 <p><input type="radio"/> The <b>[−]</b> key decreases the flashing cursor by one digit.</p>

**4**

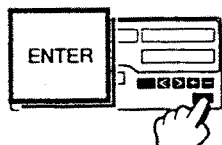

- Press the **[ENTER]** key to store the Set Point Code number.
- All three Set Point displays will flash once together. The Set Point Code is now saved.

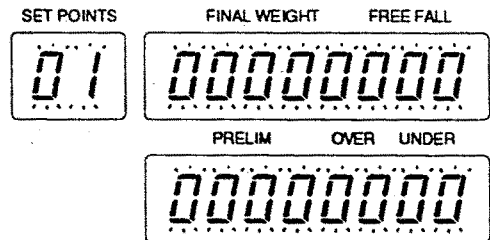

- If you do not want to save the Set Point Code setting, press the **[S.P.R.]** key to escape. Return to Step #2 to re-enter.



## Set Point Values

5

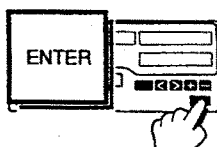

- ▶ Press the **ENTER** key.
- One of the two digits in the 2-digit display will be flashing – "0 1".

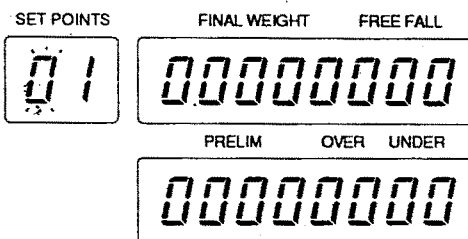

6

- ▶ Use the **<**, **>**, **+** and **-** keys to change the Set Point Values (see 'SET POINT KEY ENTERING', D-4), move the blinking cursor out of the 2-digit display and through the two 8-digit displays. The Top Set Point display provides five spaces for the Final Weight and three spaces for the Free Fall. The bottom Set Point display has four spaces for the Preliminary Weight, and two spaces each for the Over and Under Weights.

7

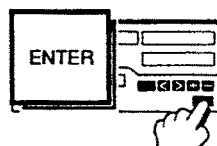

- ▶ Press the **ENTER** key to store the Set Point Values.
- All three Set Point displays will flash once together. The Set Point Values are now saved.

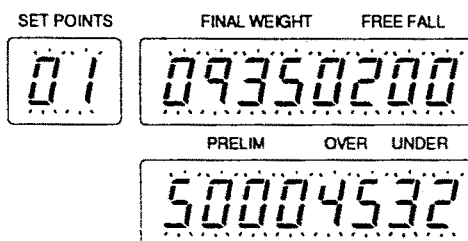

- In this example, a Final Weight of "9350" with a Free Fall value of "200", a Preliminary Weight of "5000", an Over Weight of "45", and an Under Weight of "32" was entered. **NOTE: a "0" precedes the Final Weight value and is ignored.**
- ▶ If you do not want to save the Set Point Value settings, press the **S.P.R.** key to escape. Return to Step #5 to re-enter.

8

You have now stored the Set Point Code and Set Point Values. Return to Step #2 if you wish to enter a new Set Point Code. The decimal is set by function F01.

## ⚠ Entering Decimal Points



- ❑ In the above example a Final Weight of "9350", with a Free Fall value of "200", a Preliminary Weight of "5000", an Over Weight of "45", and an Under Weight of "32" were entered.
- ❑ These Set Point Values do not have a weight measure. Thus, "9350" could be pounds or kilograms or grams, etc.. Decimal points can be placed by changing the 'F 01' setting.
- ❑ When 'F 01' is set to "1", decimal points are placed within the Final Weight, Free Value, Preliminary, Over and Under Weight settings as shown to the right. A Final Weight of "9350" becomes "935.0", the Free Fall becomes "20.0", Preliminary Weight "500.0", Over "4.5" and the Under Weight becomes "3.2". If 'F 01' is set to "2" each setting will be set to two decimal places. See F-Function 'F 01', F•8.

SET POINTS

01

FINAL WEIGHT FREE FALL

09350200

PRELIM OVER UNDER

50004532

SET POINTS

01

FINAL WEIGHT FREE FALL

0935.020.0

PRELIM OVER UNDER

500.0453.2

## About Sub Mode



This auxiliary function serves two functions:

- 1) It allows you to **CLEAR ALL** Set Point Code data stored and/or the Accumulated weight and Accumulated Count – for each Code number, in the 'SET POINT CLEARING PROCEDURE', below. If you want to erase only one Code number, or a couple – go through the 'SET POINT PROCEDURE', beginning on **D•2**, and replace each Set Point Values with "0's". See F-Function 'F 19', **F•14**, for more on Accumulated Value and Count.
- 2) It allows you to **PRINT** all Set Point and F-Function data, as well as the Minimum Division and Maximum Capacity Calibration settings. A printer must be attached to the Standard Serial port, see 'SUB MODE PRINTING PROCEDURE', **D•10**.

## Sub Mode Clearing Functions

'S 01'	Set Point Data	Set Point Clearing
'S 02'	Accumulated Data	Accumulated Value and Count Clearing

## Set Point Clearing Procedure



Once you use the Sub Mode and erase all stored Set Point memory and/or Accumulated Data – you can not recall any of that information.

**1**

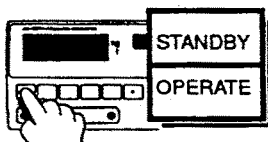

- ▶ Press the **STND/OPR** key to turn the display OFF. If the display is already OFF, do nothing.

**2**

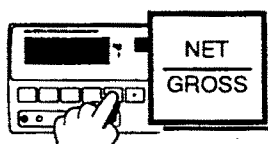

- ▶ Press the **NET/GROSS** key and **HOLD** the key in.

**3**

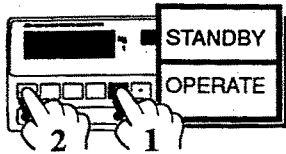

- ▶ While still holding in the **NET/GROSS** key (marked "1" to the left) – press the **STND/OPR** key (marked "2"). then release both keys.

- "Sub" will appear on the Main Display.

AD-4325A WEIGHING INDICATOR



- "01" will be shown in the 2-digit Set Point display. One of the two digits will be flashing.

SET POINTS



**4**

- ▶ If you do not want to clear all Set Point Code memory, but do want to clear the Accumulated Value and Accumulated Count (see 'F 19', F•14) – use the **+** and **-** keys to change the 2-digit Set Point display to "02" and go on to Step #6.



Please see 'SET POINT KEY ENTERING', D-4, for key descriptions.

- ▶ If you do not want to clear either Set Point Code memory or Accumulated Data – press the **S.P.R.** key to escape from the Sub mode.

- ▶ If you do want to clear Set Point Code memory press the **ENTER** key.

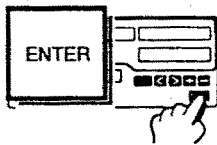

- "[Lr [d" will appear in the top Set Point display.

SET POINTS

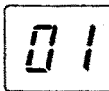

FINAL WEIGHT FREE FALL

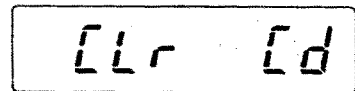

- A blinking period will appear in the bottom Set Point display.

PRELIM OVER UNDER

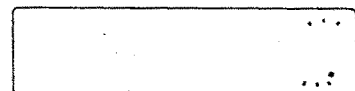

**5**

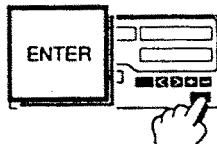

- ▶ Press the **ENTER** key again if you want to clear all the Set Point Code memory.

- ▶ If you do not want to clear all the Set Point Code memory – press the **S.P.R.** key to escape. This returns you to Step #4.

- After pressing the **ENTER** key, for a few seconds a series of periods will appear across the bottom Set Point display with the last period flashing, followed by:

PRELIM OVER UNDER

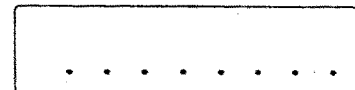

- "02" will appear in the 2-digit Set Point display. The second digit will be flashing.

SET POINTS



# Accumulated Value and Count Clearing

6

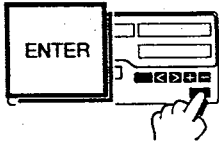

▶ Press the **ENTER** key.

- "[Lr tLl]" will appear in the top Set Point display.
- A blinking period will appear in the bottom Set Point display.

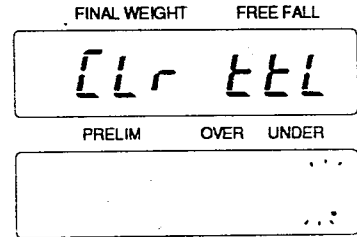
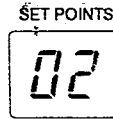

7

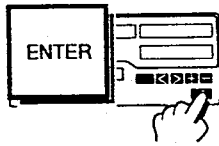

▶ Press the **ENTER** key again if you want to clear all Accumulated Data.

▶ If you do not want to clear all Accumulated Data – press the **S.P.R.** key to escape. This returns you to Step #4.

- After pressing the **ENTER** key, for a few seconds a series of periods will appear across the bottom Set Point display with the last period flashing, followed by:
- "||" will appear in the 2-digit Set Point display indicating that you have cleared all Data. The second digit will be flashing.

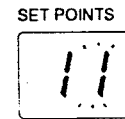
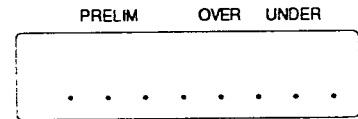

8

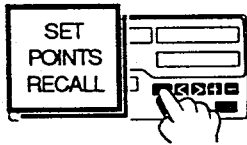

▶ Press the **S.P.R.** key to exit the Sub mode.

○ "End" will appear in the top Set Point display for a couple of seconds, then return to normal mode.

▶ If you want to print Sub Mode data, go to Step #4 in the 'SUB MODE PRINTING PROCEDURE', **D•10**.

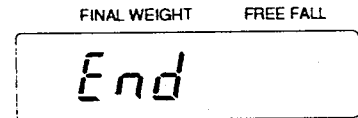

# Sub Mode Printing Procedure



To print data using the Sub Mode you must have an A&D Printer attached to the Standard Serial port. Attach either an AD-8117A or AD-8118A Printer; you will not be able to access these Sub Mode functions without a Printer.

1

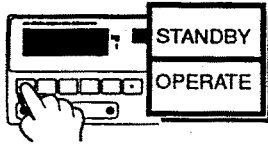

- ▶ Press the **STND/OPR** key to turn the display OFF. If the display is already OFF, do nothing.

2

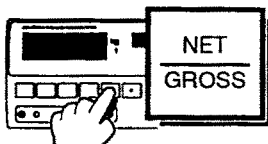

- ▶ Press the **NET/GROSS** key and **HOLD** the key in.

3

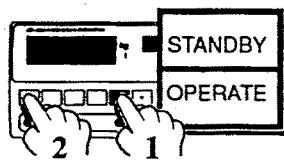

- ▶ While still holding in the **NET/GROSS** key (marked "1" to the left) – press the **STND/OPR** key (marked "2").
- "Sub" will appear on the Main Display.
- "01" will be shown in the 2-digit Set Point display. One of the two digits will be flashing.

AD-4325A WEIGHING INDICATOR

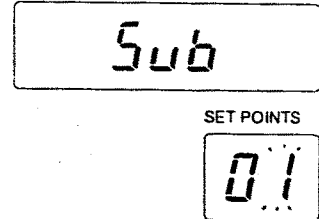

4

- ▶ If you want to print Set Point data – use the **+** and **-** keys to change the 2-digit Set Point display to "11".
- ▶ If you want to print F-Function data only – use the **<**, **>**, **+** and **-** keys to change the 2-digit Set Point display to "12" – and go to Step #7.
- ▶ If you want to print the Calibration data only – use the **<**, **>**, **+** and **-** keys to change the 2-digit Set Point display to "13" – and go to Step #9.
- ▶ If you do not want to print either the Set Point data, the F-Function data or the Calibration data – go to Step #11.

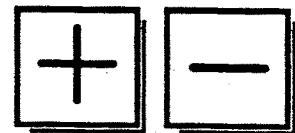

Please see 'SET POINT KEY ENTERING', D-4, for key descriptions.

## Sub Mode Printing Functions

<b>'S 11'</b>	<b>Set Point Data</b>	Prints all Set Point Data for Codes 00 ~ 99
<b>'S 12'</b>	<b>F-Function Data</b>	Prints all F-Function Data
<b>'S 13'</b>	<b>Calibration Data</b>	Prints the Cal. Min. Div. and Max. Capacity

**5**

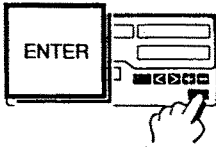

▶ Press the **ENTER** key.

○ "Prt [d]" will appear in the top Set Point display.

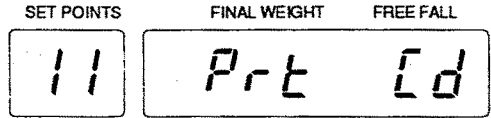

○ A blinking "2" will appear in the bottom Set Point display. If you are connected to an AD-8118A, go to Step #6. Change to "3" using the **+** and **-** keys if you are connected to an AD-8117A.

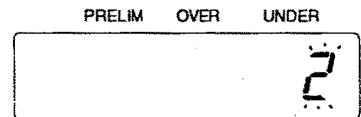

▶ This number is the printing output interval; setting values are from 0 to 9 with each value representing 0.5 seconds.

**6**

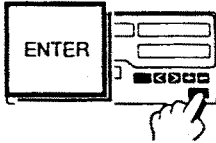

▶ Press the **ENTER** key again if you want to print all Set Point Code data.

▶ If you do not want to print all the Set Point data – press the **S.P.R.** key to escape. This returns you to Step #4.

○ After pressing the **ENTER** key, a series of numbers will sequence in the bottom Set Point display. These numbers represent the Set Point Code being printed at that time.

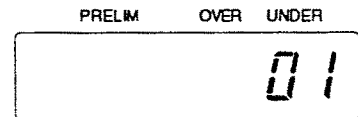

○ At the end of the printing sequence

"12" will appear in the 2-digit Set Point display. One of the digits will be flashing.

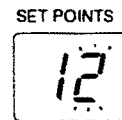

**7**

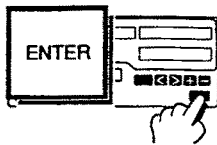

▶ Press the **ENTER** key.

○ "Prt Fnc" will appear in the top Set Point display.

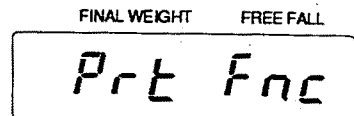
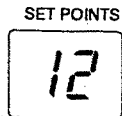

○ A blinking "2" will appear in the bottom Set Point display. If you are connected to an AD-8118A, go to Step #8. Change to "3" using the **+** and **-** keys if you are connected to an AD-8117A.

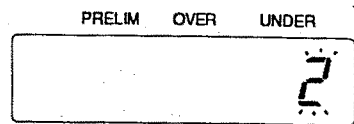

▶ This number is the printing output interval, setting values are from 0 to 9 with each value representing 0.5 seconds.

**8**

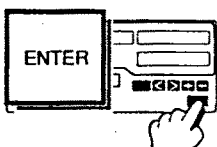

▶ Press the **ENTER** key again if you want to print all F-Function data.

▶ If you do not want to print all the F-Function data – press the **S.P.R.** key to escape. This returns you to Step #4.

○ After pressing the **ENTER** key, a series of numbers will sequence in the bottom Set Point display. These numbers represent the Set Point Code being printed at that time.

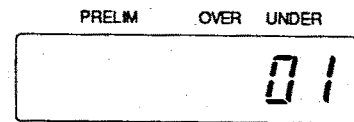

At the end of the printing sequence;

○ "13" will appear in the 2-digit Set Point display. One of the digits will be flashing.

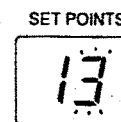

**9**

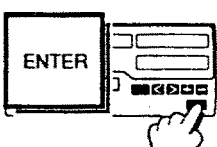

▶ Press the **ENTER** key.

○ "Prt CAL" will appear in the top Set Point display.

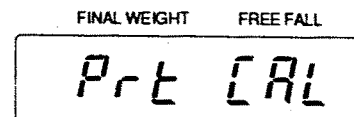
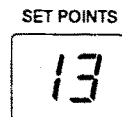

○ A blinking period will appear in the bottom Set Point display.

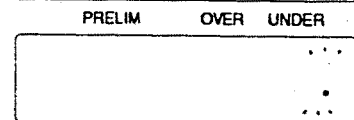



10

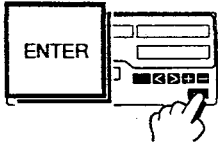

- ▶ Press the **ENTER** key again if you want to print the Minimum Division and Maximum Capacity settings from Calibration.
- ▶ If you do not want to print the Calibration settings – press the **S.P.R.** key to escape. This returns you to Step #4.

- After pressing the **ENTER** key, for about a second a series of periods will appear across the bottom Set Point display.

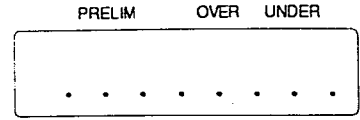

- At the end of the printing sequence "01" will appear in the 2-digit Set Point display. One of the digits will be flashing.

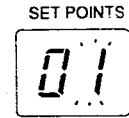

11

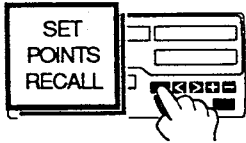

- ▶ Press the **S.P.R.** key to exit the Sub mode.
- "End" will appear in the top Set Point display for a couple of seconds, then return to normal mode.

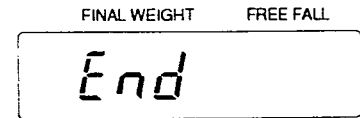

## Sub Mode Errors

### □ 'S Err' Errors:

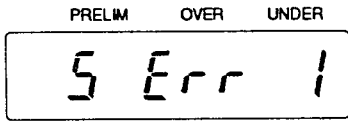

'S Err 1' will be displayed if the value in the 2-digit Set Point display does not equal to "01", "02", "11", "12" or "13".

- ▶ Re-enter the value in the 2-digit Set Point display.

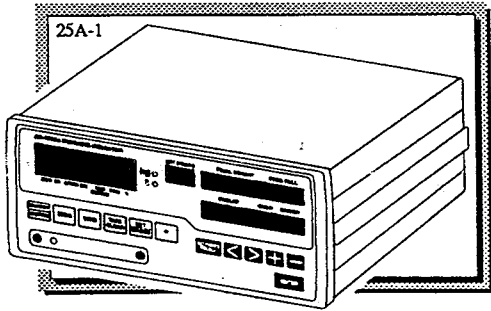

## AD-4325A • Section E

# System Check

# System Check Procedure



A System Check should be run: after initial installation, after moving your AD-4325A, after connecting or disconnecting an attachment from the Rear Panel and as a means of locating an unexplained system error. An occasional self-check to make sure everything is working properly is good maintenance practice as well.

- The System Check will check the the four displays, internal memory, the Code Input Connection, the External I/O, the Front-Panel keys and the A/D Converter.

1

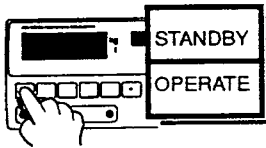

- ▶ Press the **STND/OPR** key to turn the display ON - have nothing on the weighing surface.

2

- ▶ Open the Dip-Switch cover on the front panel of the AD-4325A unit by unscrewing the knobs counter-clockwise to expose the Dip-switches.

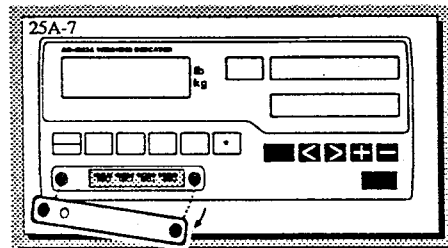

3

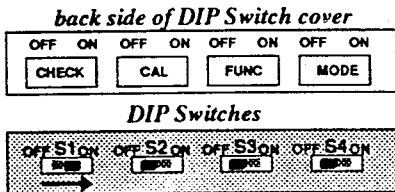

- ▶ Slide the first Dip-Switch marked "S1", ON.
- All four displays will light up, checking the fluorescent segments of each digit, for a couple of seconds.

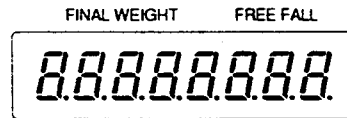
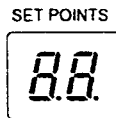
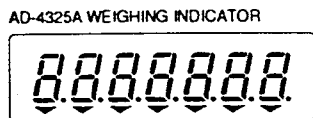

- The displays will go blank for a couple of seconds, and then:

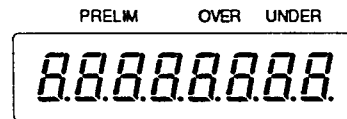

- "[HEC]" will appear on the Main Display and remain on throughout the System Check.

AD-4325A WEIGHING INDICATOR

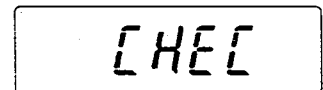

- "CHECK rR" will appear on the top Set Point display, and
- For a couple of seconds a series of periods will appear in the bottom Set Point display with the last period flashing. This is followed by:
- "Good" will appear on the bottom Set Point display indicating that the internal RAM memory has checked out okay.

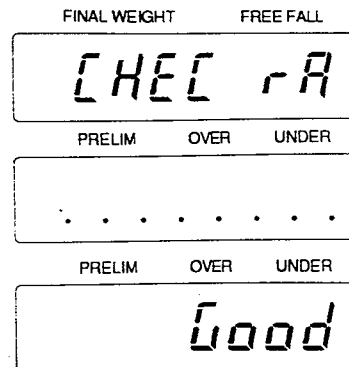

4

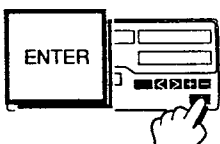

- ▶ Press the **ENTER** key to continue.
- "CHECK Cd" will appear on the top Set Point display.
- The bottom Set Point display will show an input from the Code Input Connector.

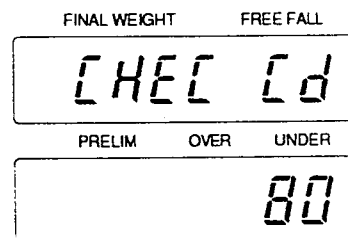

- The bottom display shows "00" in this example. "00" will be displayed if there is no Code Input connection.

5

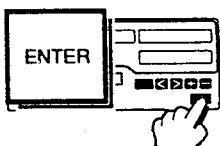

- ▶ Press the **ENTER** key to continue.
- "CHECK I0" will appear on the top Set Point display.
- The bottom Set Point display will show inputs from the Control I/O.

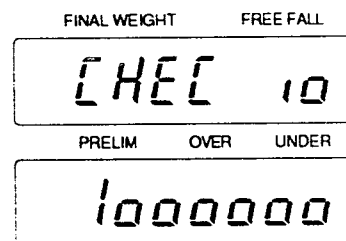

- The bottom display will show a "0" or "/" for each of the Control I/O Inputs 1 ~ 6. The first digit indicates whether or not the OP-03/04 is attached. In the example above, the RS-232C/422 Connector is attached, but no inputs are being received. If OP-03/04 is not attached the bottom Set Point display will read "0000000".

6

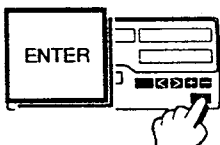

- ▶ Press the **ENTER** key to continue.
- "L000000" will appear on the top Set Point display, and
- "r000000" will appear on the bottom Set Point display.

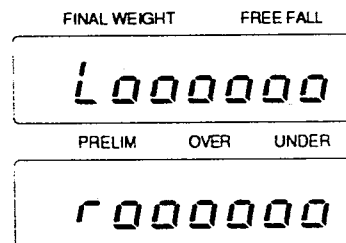

- Each "d" represents a key on the Front Panel. The top Set Point display checks the left-hand side Front-Panel keys and the bottom Set Point display checks the right-hand side Front-Panel keys. Press each key once – a "/" should appear in the appropriate digit on the Set Point displays.

**7**

- ▣ Slide the first Dip-Switch, "S1", back to the OFF position.

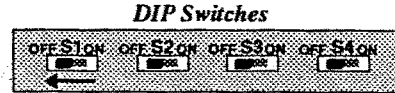
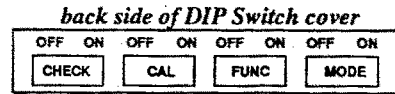

- "CHEC Ad" will appear on the top Set Point display.
- A series of periods will blink across the bottom Set Point display for a couple of seconds, followed by:
- An Analog/Digital Conversion value will appear on the bottom Set Point display for a couple of seconds. Use this value to check to see how far the SPAN value is out of range. In this example, "[ 11678" is displayed.
- "End" will then appear on the top Set Point display for a couple of seconds, then return to Normal Mode.

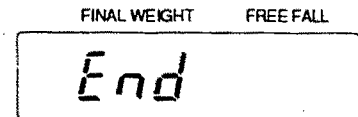
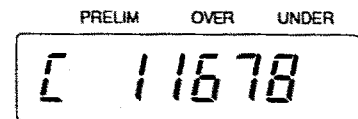
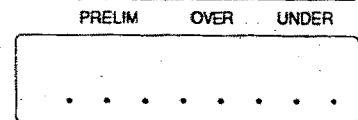
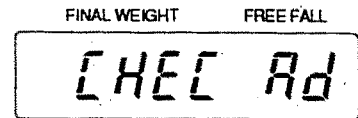

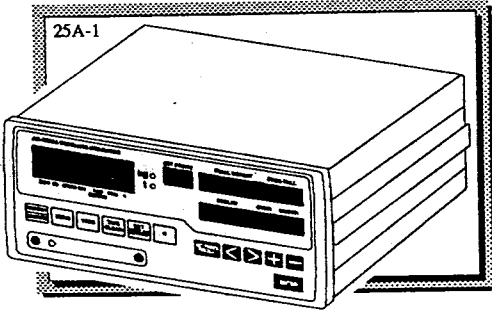

## AD-4325A • Section F

# F-Functions



# About the F-Functions



There are a number of AD-4325A functions that are selectable by the user. These functions, called F-Functions, control many of the important capabilities of the AD-4325A: Please take a moment to look through the different F-Functions on the following pages. You are able to change any F-Function listed. This is accomplished by using the following displays and keys:

## The Main Display & Two Set Point Displays

AD-4325A WEIGHING INDICATOR

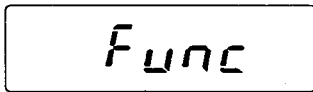

▶ When you enter the F-Function mode - "Func" will appear on the Main display.

SET POINTS



▶ The number that appears in the 2-digit Set Point display is the **F-Function Code number**. In this example you are in function "01", Decimal Point Adjustment.

FINAL WEIGHT

FREE FALL

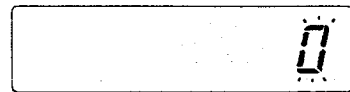

▶ The number that appears in the top 8-digit Set Point display is the **F-Function Setting**. In this example the setting for F-Function "01" is "0", meaning that there is no decimal point. See 'F 01', F-4.



Use the 'F-FUNCTION KEY ENTERING' Table below to change and move through the F-Function displays.

	<h3>F-Function Key Entering</h3>	<p>The <b>ENTER</b> key stores the settings into memory and moves to the next Code number. It can also be used to move through all the F-Functions.</p>
	<p>▶ The <b>&lt;</b> key moves the flashing cursor digit to the left.</p> <p>○ The <b>&lt;</b> key will only be able to move the cursor within a particular display.</p>	<p>▶ The <b>+</b> key increases the flashing cursor by one digit.</p> <p>Press the <b>+</b> key and ...</p>
	<p>▶ The <b>&gt;</b> key moves the flashing cursor digit to the right.</p>	<p>▶ The <b>-</b> key decreases the flashing cursor by one digit.</p>

# Changing the F-Functions

1

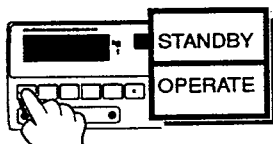

▶ Press the **STND/OPR** key to turn the display ON.

2

▶ Open the Dip-Switch cover on the front panel of the AD-4325A unit by unscrewing the knobs counter-clockwise to expose the Dip-Switches.

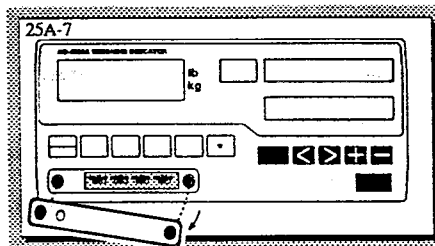

3

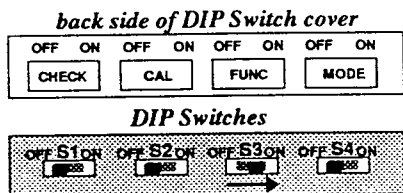

▶ Slide the third Dip-Switch marked "S3" – ON.

○ "Func" will appear on the Main display, and remain on throughout.

AD-4325A WEIGHING INDICATOR

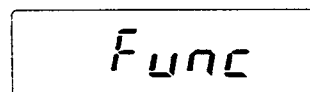

○ "01" will be flashing on the 2-digit Set Points display. This is the first F-Function.

SET POINTS

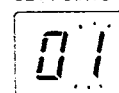

4

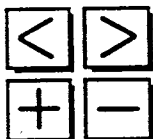

▶ If you do not want to change the first F-Function use the **+**, **-**, **←** and **→** keys to move to the F-Function you choose. See 'F-FUNCTION KEY ENTERING', F-2.

**-or-**

▶ If you do want to change 'F 01', press **ENTER**. The function setting, "01" in this example, will flash in the top right Set Point display

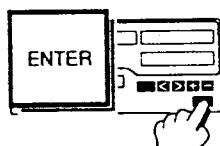

FINAL WEIGHT      FREE FALL

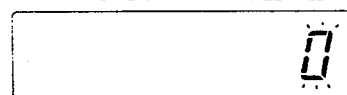



5

- ▶ You are now in F-Function 'F 01', Decimal Point Adjustment (or the F-Function you have chosen). If you want to change the placement of the decimal point in the display, choose a new setting and enter it now. Do so by using the  $\oplus$  and  $\ominus$  keys, use the 'F-FUNCTION KEY ENTERING' Table on F•2. Use 'THE F-FUNCTION SETTINGS' section beginning on F•8 as a guide as you change each individual F-Function.

Decimal Point Adjustment			
	● 0	No decimal point	123456
	1	$10^1$	123456
	2	$10^2$	123456
	3	$10^3$	123456
	4	$10^4$	123456

When the Minimum Division is set to 10, 20 or 50 - the Main Display can use 6 digits. If 'F 01' is set to "0" and the Minimum Division is set to 10, 20 or 50 the Set Point display will be multiplied by 10.

"●" indicates initial Factory and post Re-Installation setting

6

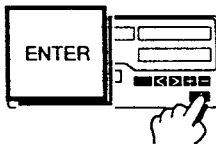

- ▶ Press the **ENTER** key if there is no change, or if you have changed to a new setting – to move forward to the next F-Function Code number.
- The next F-Function Code will appear on the small Set Point display - "02" in this example.

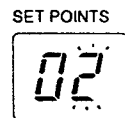

7

- ▶ You are now able to move through and change the F-Functions and their settings using Steps 4, 5 and 6. If there is no change in a function, or you simply wish to move directly to a new one:
  - 1) Move incrementally by pressing the **ENTER** key twice, or
  - 2) Use the keys described in 'F-FUNCTION KEY SETTINGS', F•2, to select an F-Function Code number.

8

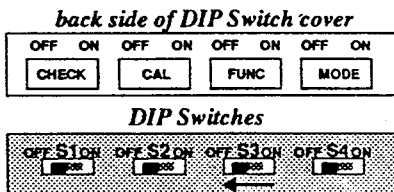

- ▶ When you have finished changing the F-Functions, slide the Dip-Switch "S3" back to the "OFF" position.
- "End" will appear on the top right Set Point display for a couple of seconds before returning to normal weighing mode.

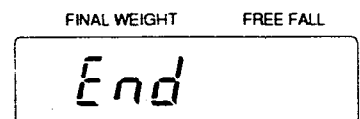

9

- ▶ Return the Dip-Switch cover to the front panel by screwing the knobs clockwise.

## F-Function Errors

### □ 'F Err' Errors:

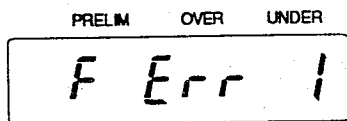

'F Err 1' will be displayed if there is not an F-Function at the number you tried to set.

- ▶ Re-enter another F-Function Code number.

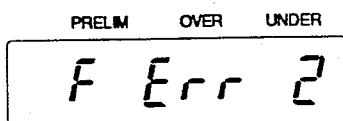

'F Err 2' will be displayed if there is not a function setting at the Code number you tried to set.

- ▶ Re-enter another function setting.

## F-Functions Listed

### F-FUNCTIONS AND SETTINGS

F 01	Decimal Point Adjustment	Displays to 1,2,3 or 4 decimal places.
F 02	Weighing Unit Selection	"kg" ↔ "l" (Not USA ver.), "lb" ↔ "kg"(USA ver.)
F 03	Display Update Rate	17 times/sec., 4 times/sec.
F 04	Digital Filter	8 steps: Weak ↔ Strong
F 05	Set ZERO Range	2% or 10% of Maximum Capacity.
F 06	Motion Detection Condition	0.5 sec., 1 count → 1 sec., 9 counts
F 07	Auto. ZERO Track. Comp.	1 sec., 0.5 division → 2 sec., 4.5 division
F 08	Automatic Free Fall Compensation Mode	Keep or Not Keep Automatic Free Fall Compensation Mode
F 09	Comparison Result Output	Normal, Locked w/ Display, or Clear Total

## FOR BATCH WEIGHING

F 10	Pulse Width of FINISH signal	0.0 sec. → 2.0 sec.
F 11	ZERO Band	Selectable (enter weight)
F 12	Optional Preliminary Weight	Selectable (enter weight)
F 13	Timer - Comparator Inhibiter	0.1 to 2.0 seconds or Disable
F 14	Automatic Free Fall Comp.	Set Weight or Disable
F 15	Weighing Mode	Select from four Batch Modes, Select whether input is from Front Panel, BCD, RS-422 or RS-232C.
F 17	TARE key Availability	Avail., N. A. at Minus Gross (Not USA version)
F 18	Timer - Finish Signal	Set between 0.1 sec. and 9.9 sec.
F 19	Batching Mode	Normal/Accumulation

## FRONT PANEL KEYS

F 20	Panel Key Disabling	Enable/Disable Selection
------	---------------------	--------------------------

## FOR STANDARD CURRENT LOOP

F 21	Baud Rate	600, 2400 Baud
F 22	Output Data	Display, GROSS, NET, TARE, or GROSS+NET+TARE Data
F 23	Output Mode	Stream, Auto Print, Manual Print, Accum. Print
F 24	Output Availability	Always available or when stable only
F 25	Output Format	Sending with code, sending w/o code
F 26 → 30	N. A.	

## FOR BCD OPTION OP-01

F 31	Output Data	Display, GROSS, NET, or TARE Data
F 32	Output Mode	Stream, Auto Print, Manual Print, Accum. Print
F 33	Output Logic	Positive Logic, Negative Logic
F 34	Output Format	Normal, for AD-8113B, for AD-8114
F 35 → 40	N. A.	

## FOR SERIAL INTERFACE OPTION OP-03/04

<b>F 41</b>	10 <sup>0</sup>	Baud Rate	600, 1200, 2400, 4800, 9600
	10 <sup>1</sup>	Data Bit Length	7 (= ASCII), 8 (MSB = 0)
		Stop Bit Length	1, 2
	10 <sup>2</sup>	Parity	EVEN, ODD, without Parity
	10 <sup>3</sup>	Terminator	<CR> <LF>, <CR>
<b>F 42</b>	Output Data		Display, GROSS, NET, TARE, GROSS+NET+TARE, Gross per Sampling, Net per Sampling
<b>F 43</b>	Output Mode		Stream, Auto Print, Manual Print, Command 1, Command 2, Accum. Print
<b>F 44</b>	Output Availability		Always available or when stable only
<b>F 45</b>	Output Format		Sending with code, sending w/o code
<b>F 46</b>	Communication Mode		With Address, w/o Address
<b>F 47</b>	Address No.		0 through 9
<b>F 48 → 50</b>		N. A.	

## FOR ANALOG OPTION OP-07

<b>F 51</b>	Analog Output Data	Display, GROSS, or NET Data
<b>F 52</b>	Output current at display ZERO	0.0mA through 99.9mA
<b>F 53</b>	Output current at Full Scale	0.0mA through 99.9mA
<b>F 54 → 60</b>		N. A.



# The F-Function Settings



"●" Indicates initial Factory and post Re-Installation setting

Decimal Point Adjustment			
<div style="font-size: 2em; font-family: monospace;">F 01</div>	● 0	No decimal point	123456
	1	$10^1$	12345.6
	2	$10^2$	12345.56
	3	$10^3$	12345.56
	4	$10^4$	12.3456

When the Minimum Division is set to 10, 20 or 50 - the Main Display can use 6 digits. If 'F 01' is set to "0" and the Minimum Division is set to 10, 20 or 50 the Set Point display will be multiplied by 10.

Weighing Unit Change			
<div style="font-size: 2em; font-family: monospace;">F 02</div>		International Ver.	USA Version
	● 1	kilogram (kg)	pound (lb)
	2	tonne (t)	kilogram (kg)

Please note that the decimal point will have to be moved if you switch between "kg" and "t". Example: 1001kg will change to 1001t - however, it is 1.001t ! The decimal point must be changed.

Display Update Rate		
<div style="font-size: 2em; font-family: monospace;">F 03</div>	● 1	17 times per second
	2	4 times per second

Digital Filter					
<div style="font-size: 2em; font-family: monospace;">F 04</div>	1	Weakest	Bad Environment    Good Environment	Response Speed – Fast    Response Speed – Slow	Filter – Less Effective    Filter – More Effective
	2	Weaker			
	3	Weak			
	● 4	Normal			
	5	Strong			
	6	Strong			
	7	Stronger			
	8	Strongest			

• This function is weighing environment dependent.

### Set ZERO Range

F 05	● 1	±2% of weighing platform Full Capacity
	2	±10% of weighing platform Full Capacity
	<p>The [ZERO] key works only if the display is within the set ±2%, or ±10% limit of the weighing platform Full Capacity.</p>	

### Motion Detection Condition

F 06	00	<p>This modifies the "stable" condition by the counts per time of non-movement before the AD-4325A recognizes the stable condition. For coarse weighing set the range high and the time to "0" for stable weighing set the range low and the time to "1".</p>
	thru 19	
	00	

### Automatic ZERO Tracking Compensation (rate of drift from ZERO)

F 07	00	<p>The ZERO Tracking Comp. function will automatically bring the display back to ZERO when there are small deviations.</p>																			
	thru 19																				
	00		<p>Disable</p> <table border="1"> <tr> <td style="text-align: center;">01</td> <td>0 = 1 second</td> </tr> <tr> <td style="text-align: center;">1</td> <td>1 = 2 seconds</td> </tr> <tr> <td style="text-align: center;">2</td> <td>2 = 0.5 Div.'s</td> </tr> <tr> <td style="text-align: center;">3</td> <td>3 = 1.0 Div.'s</td> </tr> <tr> <td style="text-align: center;">4</td> <td>4 = 1.5 Div.'s</td> </tr> <tr> <td style="text-align: center;">5</td> <td>5 = 2.0 Div.'s</td> </tr> <tr> <td style="text-align: center;">6</td> <td>6 = 3.0 Div.'s</td> </tr> <tr> <td style="text-align: center;">7</td> <td>7 = 4.0 Div.'s</td> </tr> <tr> <td style="text-align: center;">8</td> <td>8 = 5.0 Div.'s</td> </tr> <tr> <td style="text-align: center;">9</td> <td>9 = 4.5 Div.'s</td> </tr> </table>	01	0 = 1 second	1	1 = 2 seconds	2	2 = 0.5 Div.'s	3	3 = 1.0 Div.'s	4	4 = 1.5 Div.'s	5	5 = 2.0 Div.'s	6	6 = 3.0 Div.'s	7	7 = 4.0 Div.'s	8	8 = 5.0 Div.'s
01	0 = 1 second																				
1	1 = 2 seconds																				
2	2 = 0.5 Div.'s																				
3	3 = 1.0 Div.'s																				
4	4 = 1.5 Div.'s																				
5	5 = 2.0 Div.'s																				
6	6 = 3.0 Div.'s																				
7	7 = 4.0 Div.'s																				
8	8 = 5.0 Div.'s																				
9	9 = 4.5 Div.'s																				

For example: Puddles of rain form on the weighing platform. Within the limits you set, the AD-4325A will ignore the rain and automatically bring the display to ZERO for easier weighing. So, if your Maximum Capacity is 1.000lb, Minimum Division is 1 Division (0.001lb) and you set 'F 07' at "02" - every second the AD-4325A will check if more rain than 0.001lb (1 Division) has collected. If it's less, then the display will automatically ZERO. If it's more, it will not - you will have to press the [ZERO] and the cycle will start again at the new ZERO.

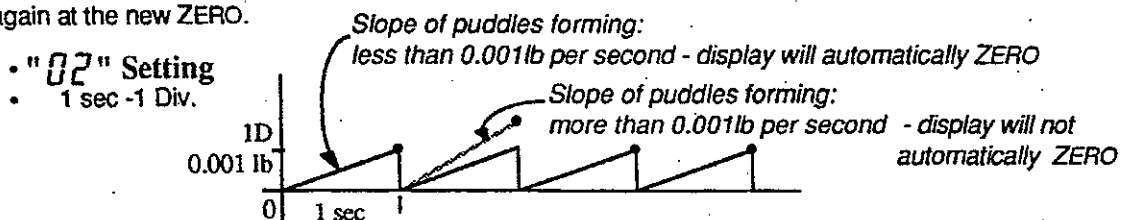

Automatic Free Fall Compensation Mode		
	1	Not Keep the Automatic Free Fall Compensation Value
	2	Keep the Automatic Free Fall Compensation Value

This setting is whether you keep the A.F.F.C. value or not, while you batch with the Automatic Free Fall Compensation (F14 not set to 0).  
 If you set this to "2", the calculated Compensation value will be stored in the Memory so that you can batch with changing the Code Number. The original Free Fall value will be replaced by this value.

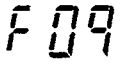
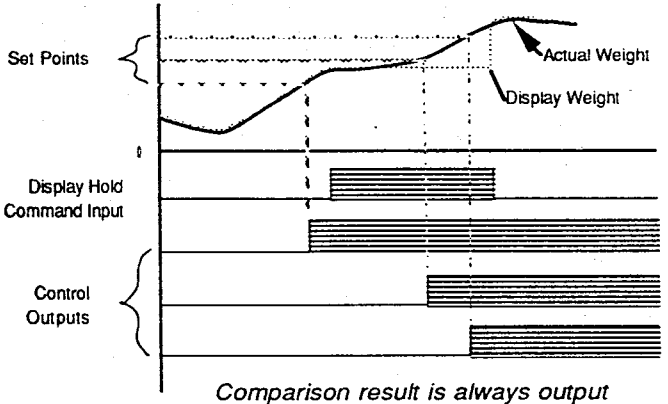
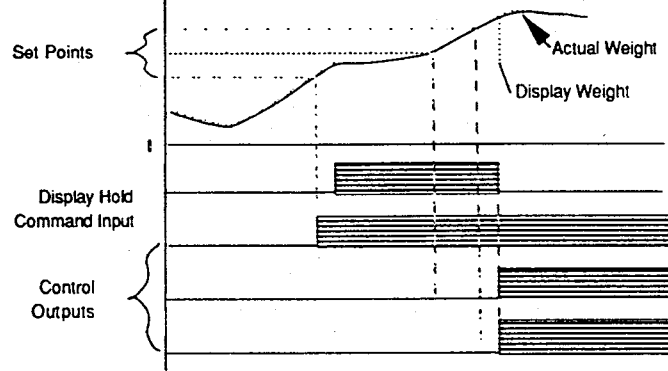
Comparison Result Output Mode-Input 6 Active, Page G.2		
	1	 <p style="text-align: center;"><i>Comparison result is always output</i></p> <p>To input on Print Command set 'F 23', 'F 32' or 'F 43' to "3". To input on Hold command set 'F 23', 'F 32' or 'F 43' to something other than "3".</p>
	2	 <p style="text-align: center;"><i>Comparison result is locked when the display is locked</i></p> <p>To input on Print command set 'F 23', 'F 32' or 'F 43' to "3". To input on Hold command set 'F 23', 'F 32' or 'F 43' to something other than "3".</p>
3	Clears all Accumulated Count and weight settings - 00 - 99.	

Note

The **ZERO**, **TARE** and **TARE RESET** commands will not work while the display has been locked.

When the display is locked, the Hold (**▼HOLD**) annunciator between **▼TARE** and **▼\*** will come ON.

AD-4325A WEIGHING INDICATOR

ZERO MD GROSS NET TARE HOLD ENTERED
lb ●  
kg ●

## ▼ For Batch Weighing

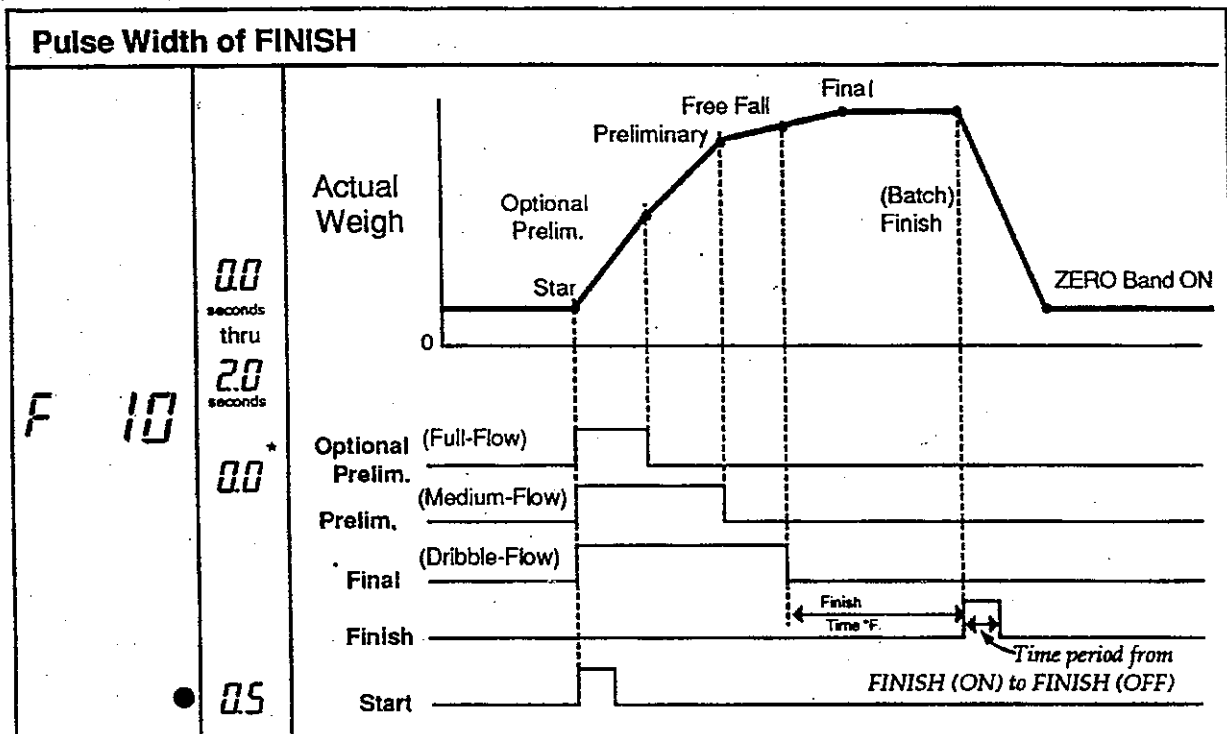

This setting sets the time period from when the FINISH signal is ON to when it goes OFF. *note:* Works only in the Built-in Automatic Program mode.  
 \* "00" = FINISH signal sent ON, and stays ON until the next START signal.

**ZERO Band**

F	11	Input the weight where the AD-4325A will read ZERO (empty). ZERO Band can be changed via the OP-03/04 Serial Input. <i>Initial setting is "000000"</i>
---	----	---

**Optional Preliminary Output**

F	12	Input the Optional Preliminary Weight. The Optional Preliminary Weight can be changed via the OP-03/04 Serial Input. <i>Initial setting is "000000"</i>
---	----	--

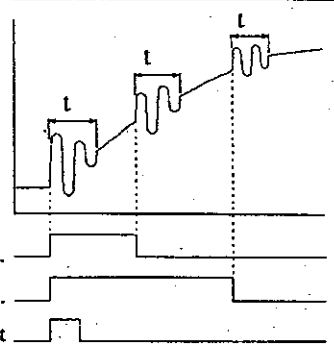

<b>Timer - Comparator Inhibiter</b>		This function is valid when F-15 is in Built-In Program mode.
F 13	<div style="text-align: center; margin-bottom: 10px;"> <span style="font-size: 1.5em;">00</span> thr <span style="font-size: 1.5em;">2.0</span> </div> <div style="text-align: center;"> <input checked="" type="radio"/> <span style="font-size: 1.5em;">00</span> Disabl                 </div>	<p>The Comparator Input Inhibiter can be set between 0.0 seconds and 2.0 seconds. If there are strong vibrations, the peaks could be mistaken for the next Set Point.</p> <div style="display: flex; justify-content: space-between; align-items: flex-start; margin-top: 10px;"> <div style="font-size: small;"> <p><i>note</i> 0.1 = 0.1 seconds</p> <p>2.0 = 2.0 seconds</p> </div> <div style="text-align: right;">  </div> </div>
<p>This setting depends on vibration. If there is little, or no vibration, then the Function is not needed ("00"). The stronger the vibration, the longer the time needed. <i>note:</i> Works only in Built-In Automatic Program Normal Batching mode.</p>		

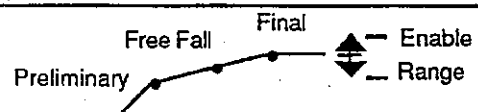
<b>Automatic Free Fall Compensation Range</b>	
F 14	<p>Free fall is the amount of material that falls into the weighting hopper after the last gate closes.</p> <p>Automatic Free Fall Compensation is used by the AD-4325V to automatically adjust the amount of Free Fall to achieve an accurate final batch weight. It is calculated when, in the Customer Programmed Control Mode, an A.F.F.C. command pulse is given (input 5, G.2). In the Built-in Automatic Program, A.F.F.C. is calculated when the Batch Finish signal is sent. The display of the Free Fall is replaced by this.</p> <p>"F14" sets the range in which the A.F.F.C. can operate. If a value of "1" is entered the range is then 1 lb. or kg. -lower and higher - from the Final,</p> <p>Output: a 2 lb or kg. range in which the A.F.F.C. can make compensations.</p> <p>A setting of "0" disables the A.F.F.C. function.</p> <p>When you use with " F8=1" :</p> <p>When you change your code number, the Compensation Value is reset. If you change the Free Fall value itself, the Compensation Value will also be reset. If you compound several materials, set the Free Fall value to "0". The Free Fall value will be different for each material.</p> <p>When you use with " F8=2" :</p> <p>The Compensation Value is stored in the memory replacing the original Free Fall Value.</p> <p>The Max Value of the compensation is 999.</p> <div style="margin-top: 10px;"> <p style="font-size: small;">Initial setting is "000000".</p>  </div>

Weighing Mode					
		RS-422, RS-232C	BCD	Front Panel	Weighing Mode
<b>F 15</b>	Customer Programmed Control Mode	21	11	● 01	Normal Batching
		22	12	02	Loss-in-Weight Batching
	Built-in Automatic Program Mode	23	13	03	Normal Batching
		24	14	04	Loss-in-Weight Batching
When entering Set Point code from the Front Panel use the settings "01-04", depending on your Batching system. Use the settings "11-14", when using the Code Input Connector on the Rear Panel and settings "21-24", when using the RS-422 (OP-03) or RS-232C (OP-04). See 'SET POINT PROCEDURE', D-2, for more information.					

TARE and ZERO keys Availability (Not available on USA version)	
<b>F 16</b>	1 ZERO & TARE keys only work when display is STABLE
	2 ZERO & TARE keys always work.

TARE key Availability (Not available on USA version)	
<b>F 17</b>	1 If the GROSS is negative (-), TARE key does not work.
	2 TARE key always works.

Timer - Finish Signal	
<b>F 18</b>	00 thr 99 ● 00 Output when stable
	<p>This Finish Signal Timer can be set between 0.0 seconds and 9.9 seconds. It adjusts the time from the Final signal to the (batch) Finish signal when there are strong vibrations. Setting "00" sends the output Finish signal only when the display is stable.</p> <div style="text-align: center;"> <p>note 0.1 = 0.1 seconds 9.9 = 9.9 seconds</p> <p>note: Works only in the Built-In Automatic Program mode.</p> </div>

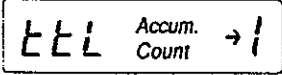
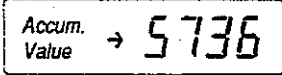
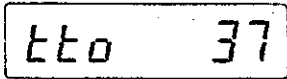
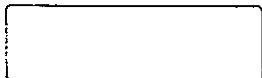
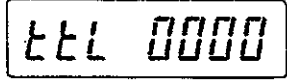
Batching Mode		
1	<b>Normal (Sequencing) Mode</b>	<p>Allows two Set Point Codes to be Sequenced automatically.</p> <p>In the Built-in Automatic Programmed Control Mode a second Set Point code can be entered after the Start signal (Input 4, G.2) is sent to start the first batch. Upon entering the second Set Point code the display will return to the first Set Point code and first Set Point code will be active. At the time the Batch Finish Signal, G.10, is output for the first batch the second Set Point will be displayed and will be active, ready for the second batch.</p> <p>In the Customer Programmed Mode the second Set Point is entered while the Set Point "data" read Inhibit is active (Input 4, G.2). At the end of the first batch if Input 4 is deactivated, the second Set Point code will be displayed and will be active.</p>
2	<b>Accumulation Mode</b>	<p>When the <input checked="" type="checkbox"/> key is pressed, the Accumulated Count and Accumulated Value will be displayed (see below).</p>
<p>0 The top Set Point display will show the Accumulated Count and the lower Set Point display the Accumulated weight after pressing the <input checked="" type="checkbox"/> key. Press the <input checked="" type="checkbox"/> key again to return to Normal mode.</p> <div style="display: flex; justify-content: space-around; align-items: flex-start;"> <div style="text-align: center;"> <p>SETPOINTS</p>  </div> <div style="text-align: center;"> <p>FINAL WEIGHT    FREE FALL</p>  </div> </div> <div style="display: flex; justify-content: center; align-items: center; margin-top: 10px;"> <p style="margin-right: 10px;">PRELIM    OVER    UNDER</p>  </div>		
<p><input checked="" type="checkbox"/> You can only clear the Accumulated Count and weight and change the Code number from the Front Panel. Clear the Accumulated settings by following the steps listed below. When 'F 09' is set to "3", the Accumulated Value can be cleared through the Control I/O input 6.</p> <p><input checked="" type="checkbox"/> In the Built-in Automatic Program Weighing Modes, "f15" page F.13, accumulation occurs at the batch finish signal output, page G.10.</p> <p style="padding-left: 40px;">In the Customer Programmed control Weighing Modes, accumulation will occur when Input 5,g.2, is pulsed to COM1.</p>		
<p><input checked="" type="checkbox"/> The bottom Set Point display will blank when the accumulated weight value is overloaded and an error will be output by the Control I/O Output 9, G.3. Plus max is 99999999 and Minus max is - 9999999.</p> <div style="display: flex; justify-content: center; align-items: center; margin-top: 10px;"> <p style="margin-right: 10px;">FINAL WEIGHT    FREE FALL</p>  </div> <div style="display: flex; justify-content: center; align-items: center; margin-top: 10px;"> <p style="margin-right: 10px;">PRELIM    OVER    UNDER</p>  </div>		
<p><input checked="" type="checkbox"/> Only the last four digits of the Accumulated Count will be displayed on the top Set Point display when it is overloaded. Max is 9999.</p> <div style="display: flex; justify-content: center; align-items: center; margin-top: 10px;"> <p style="margin-right: 10px;">FINAL WEIGHT    FREE FALL</p>  </div>		

F 19

## ⚠ Accumulated Value and Count Clearing



**Once you erase all stored Accumulated Data – you can not recall any of that information.**

1

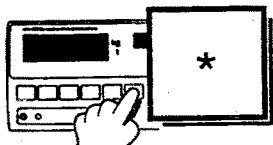

- ▶ Press the **[\*]** key to enter the Accumulation Mode, the Star (▼\*) Annunciator will appear on the display. If you are already in the Accumulation Mode, do nothing.

2

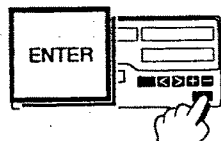

- ▶ Press the **[ENTER]** key.
- One of the two digits in the 2-digit Set Point display will be flashing.

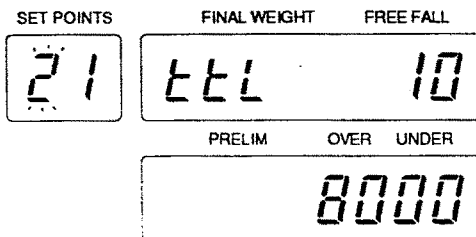

3

- ▶ Use the **[<]** and **[>]** keys to move the blinking cursor through the 2-digit Set Point display and across the top Set Point display.
- "EEE" in the top Set Point display will be replaced by "EEE".

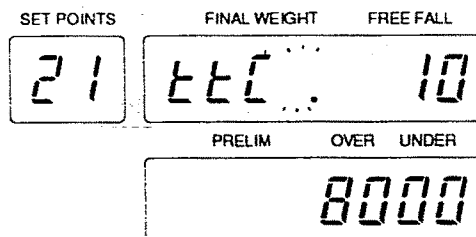

4

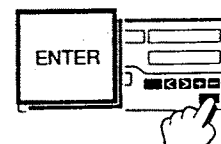

- ▶ If you want to clear the Accumulated settings press the **[ENTER]** key.
- ▶ To escape, press the **[S.P.R.]** key and go to step #3.
- All three Set Point displays will flash once and reset to zero.
- ▶ The Accumulated Count and Value settings are now cleared.

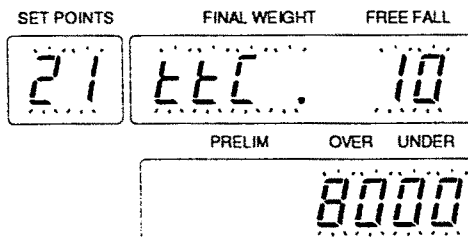

5

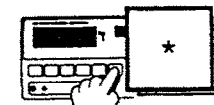

- ▶ Press the **[\*]** key to return to Normal Mode.

## Front Panel Keys

**Panel Key Disable Selection – Dip-Switch "S4" ON**

This function allows you to select Front Panel keys to be enabled/disabled when the Mode Dip-Switch, "S4" is ON. (see right)

**back side of DIP Switch cover**

OFF	ON	OFF	ON	OFF	ON	OFF	ON
CHECK	CAL	FUNC	MODE				

**DIP Switches**

Each of the eight digits on the top Set Point display represent one of the keys on the Front Panel. The keys are labeled "1-8" to the left.

key enabled → 0 ← key disabled

• initial setting is "11111111"

note: You have to slide Dip-Switch "S4" ON for 'F 20' to work.

## For Standard Current Loop

Baud Rate (serial out for display/printer)		
F 21	1	600 BPS
	2	2400 BPS

Output Data		
F 22	1	Same as Display
	2	GROSS Data
	3	NET Data
	4	TARE Data
	5	GROSS Data, NET Data, TARE Data

Output Mode		
F 23	1	Stream
	2	Auto Print Mode
	3	Manual Print Mode
	4	Accumulate and Print

Output Availability		
F 24 <sup>●</sup>	1	Always available
	2	Output when stable only

Output Format		
F 25 <sup>●</sup>	1	Sending with Set Point Code number
	2	Sending without Code number

### ⚡ For BCD Option OP-01

Output Data		
F 31 <sup>●</sup>	1	Same as Display
	2	GROSS Data
	3	NET Data
	4	TARE Data

Output Mode		
F 32 <sup>●</sup>	1	Stream
	2	Auto Print Mode
	3	Manual Print Mode
	4	Accumulate and Print

Output Logic		
F 33 <sup>●</sup>	1	Positive Logic
	2	Negative Logic

Output Format		
F 34 <sup>●</sup>	1	Normal sending
	2	Format for AD-8113B Printer
	3	Format for AD-8114 Printer
If 'F 34' is set to "1", the OP-01 Connector pins #34 ~ #41 output Set Point Code numbers. If 'F 34' is set to "2" or "3", then pins #34 ~ #41 output Unit signals. See 'PARALLEL BCD OUTPUT', H-2.		

**For Serial Interface Option OP-03/04**

<b>F 41</b>	$10^0$	<b>Baud Rate</b>			
		1	600 BPS <i>for OP-04 only</i>		
		2	1200 BPS		
		3	2400 BPS		
		4	4800 BPS <i>not for use with Current Loop</i>		
	5	9600 BPS <i>not for use with Current Loop</i>			
	$10^1$	Data Bit Length		<b>Stop Bit Length</b>	
				1	2
		7	8	2	3
	$10^2$	<b>Parity</b>			
		0	EVEN		
		1	ODD		
	$10^3$	<b>Terminator</b>			
		0	LF		
		1	CR		

Output Data		
<b>F 42</b>	1	Same as Display - Update rate = F 03
	2	GROSS Data - Update rate = F 03
	3	NET Data - Update rate = F 03
	4	TARE Data - Update rate = F 03
	5	GROSS, NET, & TARE Data - Update rate = F 03 <span style="float: right;"><i>for OP-03, F46=1 only</i></span>
	6	GROSS Data - Update rate = 70/sec. <i>for OP-03, F46=1 only</i>
	7	NET Data - Update rate = 70/sec. <i>for OP-03, F46=1 only</i>

Output Mode		
<b>F 43</b>	1	Stream <span style="float: right;"><i>for OP-03, F46=1 only</i></span>
	2	Auto Print Mode <span style="float: right;"><i>for OP-03, F46=1 only</i></span>
	3	Manual Print Mode <span style="float: right;"><i>for OP-03, F46=1 only</i></span>
	4	Command Mode # 1
	5	Command Mode # 2
	6	Accumulate and Print <span style="float: right;"><i>for OP-03, F46=1 only</i></span>

Output Availability		
F 44	1	Always available
	2	Output when stable only

Output Format		
F 45	1	Sending with Set Point Code number
	2	Sending without Code number

Communication Mode (for OP-03 only)		
F 46	1	Sending without Address
	2	Sending with Address

Address Number (for OP-03 only)		
F 47	0 thru 9 0	Setting this, the Address is set to 00, 01, ... or 09

**▼ For Analog Option OP-07**

Analog Output Data		
F 51	1	Same as Display
	2	GROSS Data
	3	NET Data

Output Current at Display Zero		
F 52	00 thru 999	0.0mA through 99.9mA <i>Factory set at "40" mA</i>

Output Current at Full Scale		
F 53	00 thru 999	0.0mA through 99.9mA <i>Factory set at "200" mA</i>



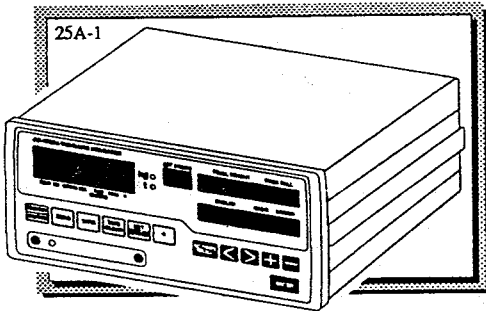

## AD-4325A • Section G

# I/O Interfacing

# Control I/O External Interface



Connect attachment wires from your Control board to the Control I/O on the rear panel, pictured below. Attach the wires in the same way you attached the load cell and power supply.

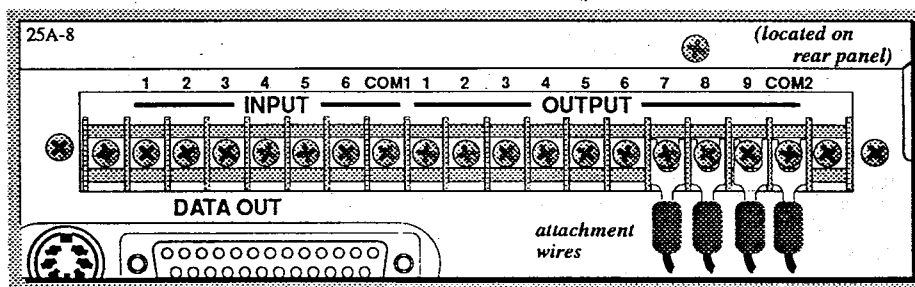

The Input and Output screws pictured above correlate to the screw explanations below. Input screws are active when shorted to their respective commons.

## Screw Arrangement

Screw	Signal Name	Description
Input 1	ZERO Input (pulse input)	AD-4325A returns to the center of ZERO when the weighing device is empty.
Input 2	TARE Input (pulse input)	AD-4325A switches to TARE mode, ZERO's the display and stores the TARE weight in memory.
Input 3	TARE Reset (pulse input)	TARE value is cleared.
Input 4	Built-In Program Mode Start Batch Input (pulse input)	Batching will be started when this input is shorted to COM1. See pages G-10 and G-13.
	Customer Program-Control Mode Setpoint 'data' read inhibit input	When this input is shorted to COM1, the AD-4325A will allow a 2nd Set Point code to be entered into memory for immediate recall. After the 2nd Set Point is entered the display will return to the first Set Point. Once the short to COM1 is removed, the 2nd Set Point code will be displayed and will be active.
Input 5	Built-In Program Mode Abort the Batch (pulse input)	If this input is shorted to COM1, the batch is aborted and FINISH signal is sent. If F 19 is set to "2", then NET weight data is also accumulated.
	Customer Program-Control Mode Automatic Free Fall comp. Command (pulse input)	When input is Pulsed for a minimum of 200ms to COM1, AD-4325A will estimate the Free Fall value for the next batch. If F 19 is set to "2", then NET weight data is also accumulated.

Screw	Signal Name	Description
Input 6	Display HOLD input	<ul style="list-style-type: none"> <li>If F 9 is not set to "3" and neither F 23, F 32 nor F 43 is set to "3" this screw will act as a HOLD input.</li> <li>When this screw is shorted to COM1, all data output and the display will be frozen.</li> </ul>
	Display PRINT Command input (pulse input)	<ul style="list-style-type: none"> <li>If F 9 is not set to "3" or "2" and either F23, F32 or F43 is set to "3" this screw will act as a PRINT Command input.</li> <li>If this command is accepted, data will be sent one time.</li> </ul>
	Display Accumulation Clear input (pulse input)	<ul style="list-style-type: none"> <li>If F 9 is set to "3", this screw will act as an Accumulation Clear input.</li> <li>If this command is accepted, all the accumulated weight and accumulated count will be cleared.</li> </ul>
<b>COM1</b>	Input Common	
Output 1	ZERO Band Output	GROSS Weight < ZERO Band
Output 2	Optional Preliminary Output (Full Flow Output)	Normal Mode - Net Weight $\geq$ Final Output - Optional Preliminary Output Loss-in-Weight - Gross Weight > Optional Preliminary Output
Output 3	Preliminary Output (Medium Flow Output)	NET Weight $\geq$ Final Output - Preliminary Output
Output 4	Final Output (Dribble-Flow Output)	NET Weight $\geq$ Final Output - Free Fall
Output 5	Over Limit Output	NET Weight > Final Output + Over Limit Output
Output 6	Under Limit Output	NET Weight > Final Output - Under Limit Output
Output 7	Batch Finish Output	When weighing is completed the Final signal is turned ON in Built-in Program Normal Batching Mode. Signal is not sent in Customer Programmed Normal Batching Mode. If F 19 is set to "2", then NET weight data can be accumulated.
Output 8	Motion Detection Output	Open (ON) in stable state and closed when in motion.
Output 9	Error Output	<ul style="list-style-type: none"> <li>If GROSS Weight is out of the 2% / 10% ZERO range when ZERO input is accepted.</li> <li>Overloaded or Under-loaded.</li> <li>If the Accumulated totals are over.</li> </ul>
<b>COM2</b>	Output Common	

# Control I/O Circuitry

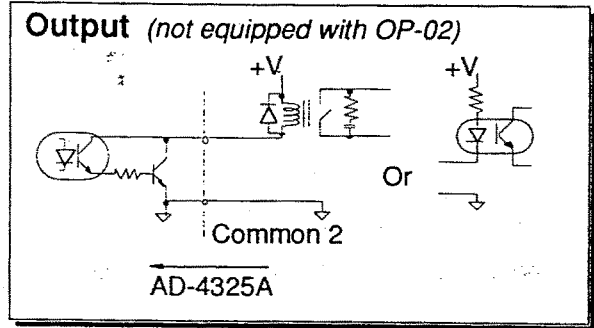
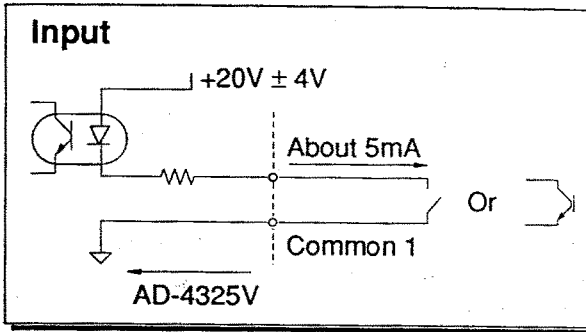

- When the **Output** circuit is **NOT** equipped with Option OP-02, please use optical isolator or relay.
- The excitation (or driving) capacity of the relays should be 12~24V DC and 50mA DC maximum.
- The pulse width of the inputs should be at least 200msec.

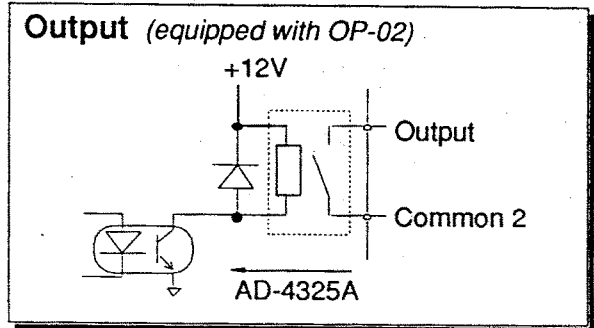



# Normal Batching

'F 15' is set at "01", "11", or "21"

## Customer Programmed Control Mode

For this explanation the following hold true:

- When AD-4325A appears in the left-hand column— action is performed by the AD-4325A controller. When Program appears action is performed by a customer-generated program and when Operator or Program appears action is performed by an operator, or the customer-generated program.

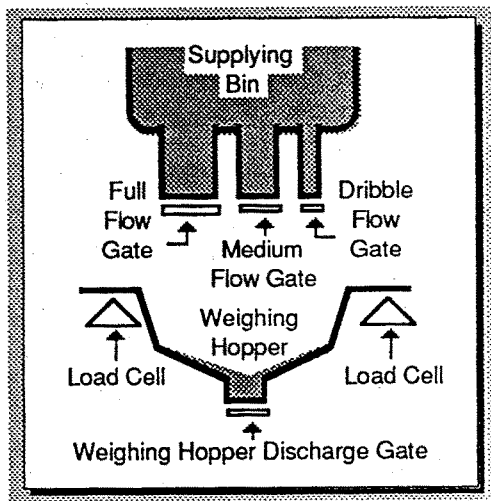

- Output and Input numbers in parenthesis refer to the Control I/O 'SCREW ARRANGEMENT' table on G•2 and G•3.
- The following can be connected:
  - Optional Preliminary Output (output 2) to the Weighing Hopper Full-Flow Gate controller.
  - Preliminary Output (output 3) to the Medium-Flow Gate controller.
  - Final Output (output 4) to the Dribble-Flow Gate controller.

1

Start

- The Weighing Hopper is empty, the display shows "0", and all Gates are closed.

2

Operator or Program

- ▣ Input a Set Point code number  
If the display is not at ZERO, input a TARE or ZERO signal, whichever is appropriate, to Zero the display.

3

Operator or Program

- ▣ Open the Supplying Bin's: Full-Flow Gate, Medium-Flow Gate, and Dribble-Flow Gate.

4

AD-4325A

- When the display reaches Optional Preliminary value (see 'F 12', F•11), the Optional Preliminary Output signal will be sent, or - "come ON".

5

Program

- ▣ Close the Full-Flow Gate by using the Optional Preliminary Output ON signal.

6

AD-4325A

- When the display reaches Preliminary (Final minus Preliminary value) the Preliminary Output signal will be sent, or - "come ON".

7

Program

- ▣ Close the Medium-Flow Gate by using the Preliminary Output ON signal.

8

AD-4325A

- When the display reaches Free Fall (Final minus Free Fall value) the Final Output signal will be sent, or - "come ON".
- ▣ An Automatic Free Fall Compensation command (Min.200ms pulse to input 5, G•2) may be given at this time.

9

Program

- ▣ Close the Dribble-Flow Gate by using the Final Output ON signal.

10

Program

- ▣ After Free Fall has stopped - check to see if the Over and Under Limit signals are OFF. If both outputs are OFF then the batch is completed correctly.



If you change the Automatic Free Fall Set Point value (D•4) – either from the Front Panel or the RS-232C/422 – the learned Free Fall value will be cleared.

11

Program

- ▣ The AD-4325A does not have a Discharge Gate control for the Weighing Hopper - use the Final signal plus a time period as the control signal to open the Weighing Hopper Discharge Gate.

12

AD-4325A

- When the GROSS weight is below ZERO Band ('F 11', F•11), the ZERO Band Output will come ON - signifying the Weighing Hopper is empty.

13

Program

- ▣ Close the Weighing Hopper Discharge Gate by using the ZERO Band Output ON signal.
- You are now ready for your next batching event.

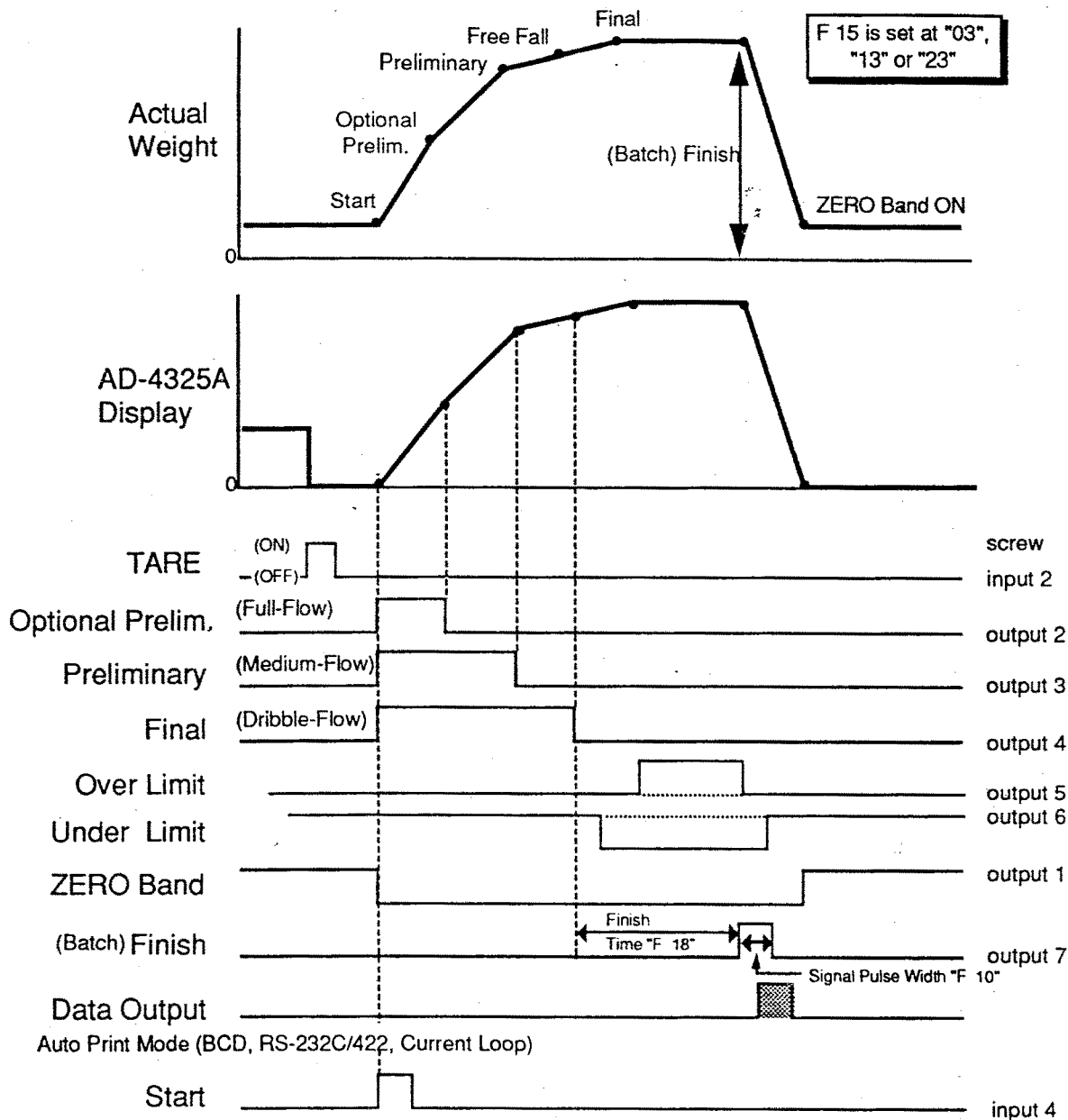



# Loss-in-Weight

'F 15' is set at "02", "12", or "22"

## Customer Programmed Control Mode

For this explanation the following hold true:

- ☐ When AD-4325A appears in the left-hand column – action is performed by the AD-4325A controller. When Program appears action is performed by a customer-generated program and when Operator or Program appears action is performed by an operator, or the customer-generated program.

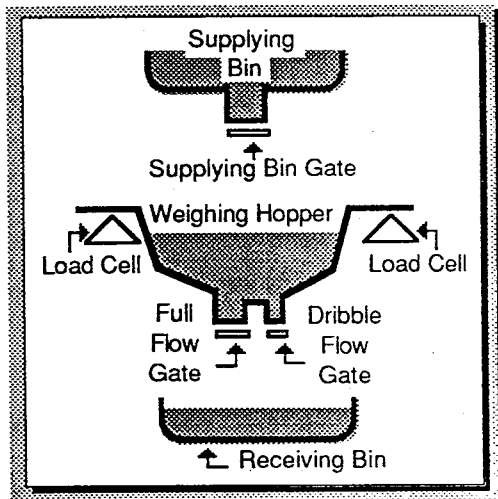

- ☐ Output and Input numbers in parenthesis refer to the Control I/O 'SCREW ARRANGEMENT' table on G-2 and G-3
- ☐ The following can be connected:
  - Optional Preliminary Output (output 2) to the Supplying Bin Gate controller.
  - Preliminary Output (output 3) to the Weighing Hopper Full-Flow Gate controller.
  - Final Output (output 4) to the Weighing Hopper Dribble-Flow Gate controller.

1

Start

- The Weighing Hopper is empty as is the Receiving Bin. The display shows "0", and all Gates are closed.

2

Operator or Program

- ☑ Input a Set Point Code number  
Open the Supplying Bin Gate.

3

AD-4325A

- When the display reaches the Optional Preliminary value (see 'F 12', F-11), the Optional Preliminary Output signal will be sent, or - "come ON".

4

Program

- ☑ Close the Supplying Bin Gate by using the Optional Preliminary Output ON signal.



The displayed weight will exceed the Optional Preliminary value by the Free Fall value. This weight is not necessarily accurate - but accuracy is not needed here since the purpose of this event is to fill up the Weighing Hopper. The Optional Preliminary value is always compared to GROSS weight.

5

Operator or Program

- ☑ Input a TARE signal (input 2) to ZERO the display.

6

AD-4325A

- Display goes to ZERO.



7

Operator or Program

8

AD-4325A

9

Program

10

AD-4325A

11

Program

▶ Open the Hopper Full-Flow Gate and Weighing Hopper Dribble-Flow Gate for Full-Flow filling into the Receiving Bin.

○ When the display reaches Preliminary (Final minus Preliminary value) the Preliminary Output signal will be sent, or - "come ON".

▶ Close the Hopper Full-Flow Gate by using the Preliminary Output ON signal.

○ Full-Flow filling is now completed.

○ When the display reaches Free Fall (Final minus Free Fall value) the Final Output signal will be sent, or - "come ON".

▶ An Automatic Free Fall Compensation command (Min. 200ms pulse to input 5, G•2) may be given at this time.

▶ Close the Weighing Hopper Dribble-Flow Gate by using the Final Output ON signal.

F 15 is set at "02", "12" or "22"

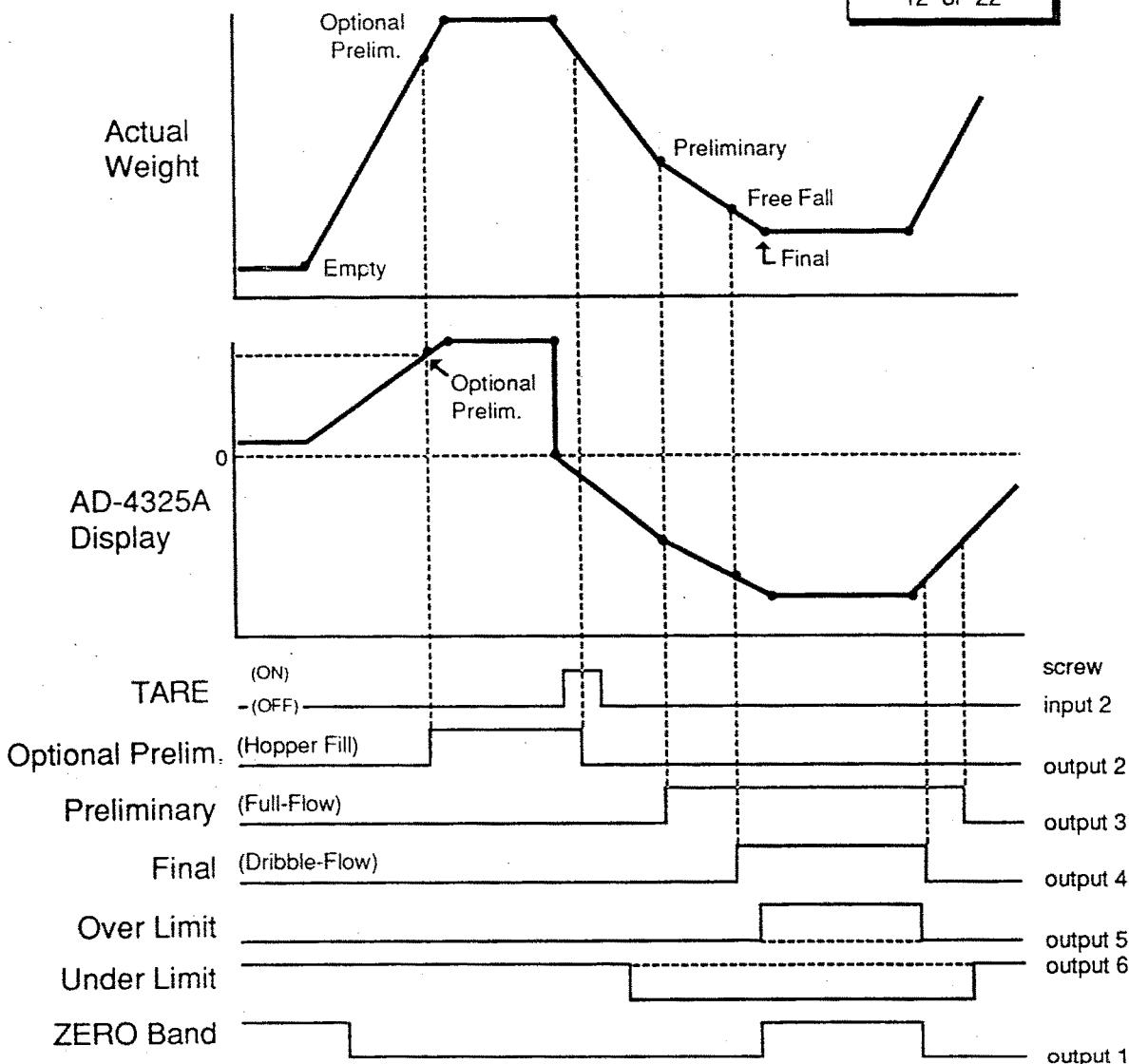



- After Free Fall has stopped, the display will show the Final value.
- ▣ If you change the Free Fall value (**D•5**) – either from the Front Panel or the RS-232C/422 – the learned Free Fall value will be cleared.



If you used the Over and Under Limit signals, please check that both of them are OFF - meaning the Final Weight is within acceptable limits, and the Receiving Bin has received the correct weight.

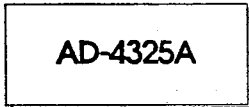

- If the GROSS weight of the Weighing Hopper is below the ZERO Band Set Point ('F 11', **F•11**), the ZERO Band Output will be ON.
- ▣ Please use ZERO Band Output for refilling if needed.

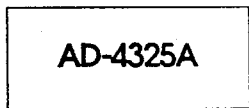

- Ready for next batching event.



# Normal Batching

'F 15' is set at "03", "13", or "23"

## Built-in Automatic Program

For this explanation the following hold true:

- When AD-4325A appears in the left-hand column – action is performed by the AD-4325A. When Built-in Auto Program appears action is performed by the AD-4325A Built-In Automatic Program and when

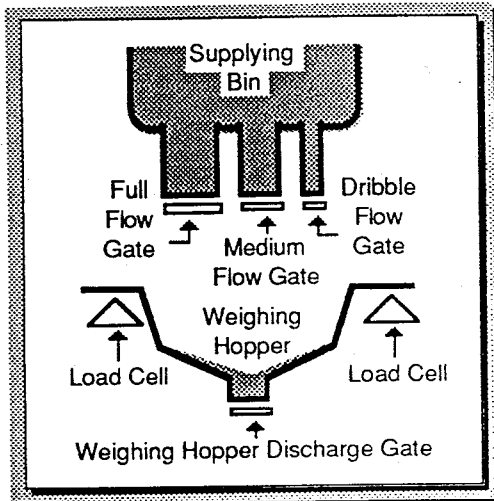

Operator or Program appears action is performed by an operator, or the customer generated program.

- Output and Input numbers in parenthesis refer to the Control I/O 'SCREW ARRANGEMENT' table on G-2 and G-3.
- The following can be connected:
  - Optional Preliminary Output (output 2) to the Weighing Hopper Full-Flow Gate controller.
  - Preliminary Output (output 3) to the Medium-Flow Gate controller.
  - Final Output (output 4) to the Dribble-Flow Gate controller.
  - Start signal Input is from input 4.

1

Start

- The Weighing Hopper is empty, the display shows "0", and all Gates are closed.

2

Operator or Program

- ▶ Input a Set Point Code number.
- ▶ If the display is not at ZERO, input a Tare or Zero signal, whichever is appropriate to re-ZERO the display.

3

Operator or

- ▶ Check that the Weighing Hopper is empty by monitoring the ZERO Band Output ('F 11', F-11).

**5**

**AD-4325A**

- When the display reaches Optional Preliminary value (Final minus Optional Preliminary Value), the Optional Preliminary Output signal will go OFF.
- The Full-Flow Gate will be closed by using the Optional Preliminary Output OFF signal.

**6**

**AD-4325A**

- When the display reaches Preliminary (Final minus Preliminary value), the Preliminary Output signal will go OFF.
- The Medium-Flow Gate will be closed by using the Preliminary Output OFF signal.

**7**

**AD-4325A**

- When the display reaches Free Fall (Final minus Free Fall value) the Final Output signal will go OFF (see 'F 14', F•12).
- The Dribble-Flow Gate will be closed by using the Final Output OFF signal.

**8**

**Built-In Auto Program**

- Batch Finish signal is sent after the set time period (see 'F 18', F•13) or when the display is stable ('F 18' default).

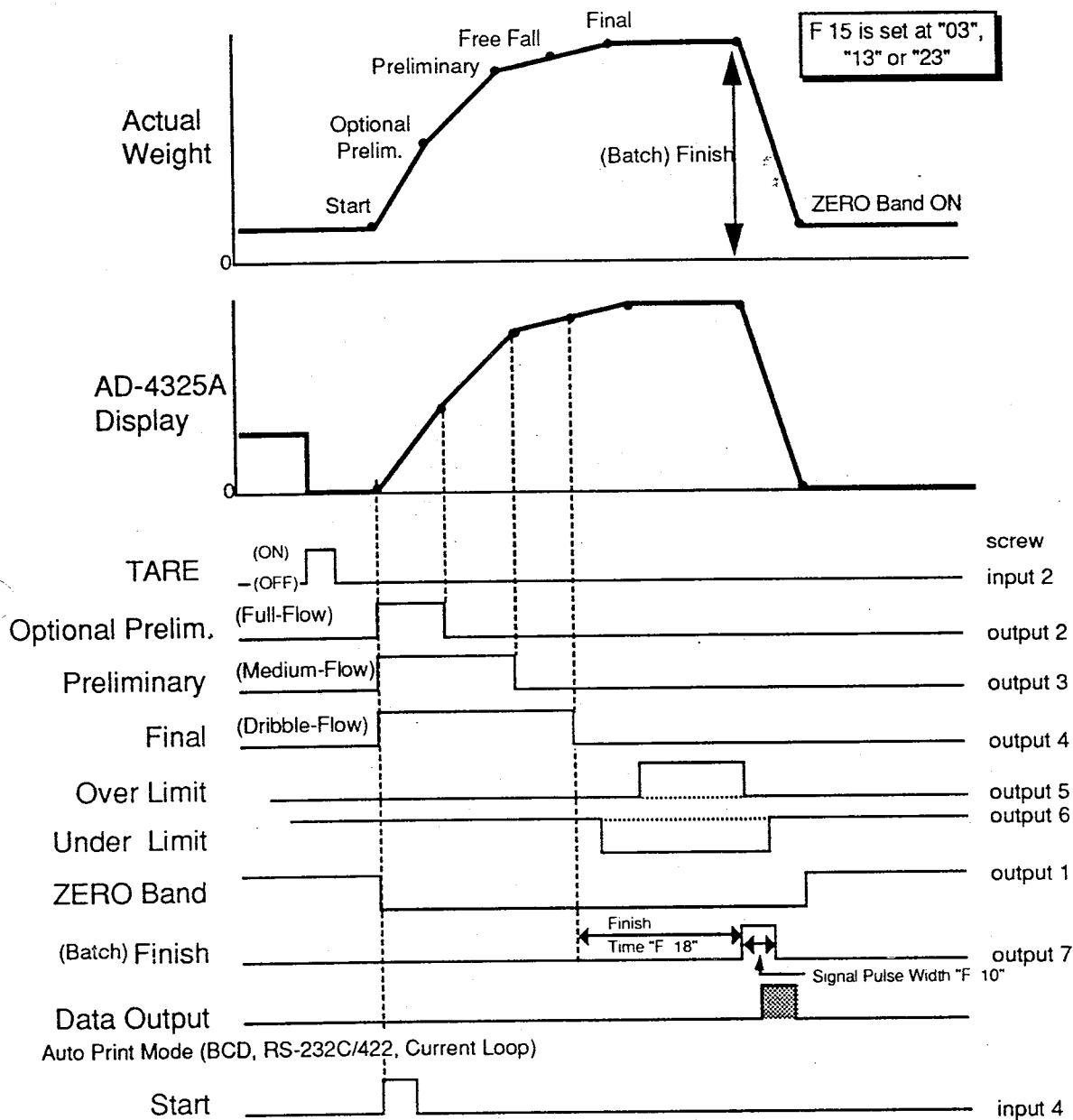

**9****Operator or Program**

- ▶ If you used Over and Under Limits – after Free Fall has stopped, check that both signals are OFF. If both outputs are OFF, then the batch is completed correctly.
- Automatic Free Fall ('F 14', F•12) is now recalculated for the next event.
- The Weighing Hopper Discharge Gate will be opened by using the Finish Output ON signal.



If you change the Free Fall Set Point value – either from the Front Panel or the RS-232C/422 – the learned Free Fall value will be cleared.

**10****Built-In Auto Program**

- Data Output is sent (Auto Print Mode: BCD, RS-232C/422 or Current Loop). If 'F 19' is set to "2" (F•14), the Data out totals the Net weight.

**11****AD-4325A**

- Ready for next batching event.



If an Abort signal is sent (input 5) anytime after the Start signal is received, then:

- Optional Preliminary, Preliminary and Final signals will go OFF, and Gates will close.
- Batch Finish and Data Output signals will be sent.
- NET weight is totalled (if 'F 19' is set to "2").

During a normal batching event, do not press the **TARE** or **STNDIOPR** keys.



*Please note that the idea of Free Fall is based upon the concept of solids falling (after the flow has been cut to ZERO) from a Supplying Bin into a Weighing Hopper. When liquids are being added to a Weighing Hopper, wave propagation must be kept to a minimum to avoid load oscillation. If a submerged filling probe is employed (which may mean ZERO Free Fall) liquid displacement must be taken into consideration.*



# Loss-in-Weight

'F 15' is set at "04", "14", or "24"

## Built-in Automatic Program

For this explanation the following hold true:

- When AD-4325A appears in the left-hand column – action is performed by the AD-4325A. When Built-in Auto Program appears action is performed by the AD-4325A Built-In Automatic Program.

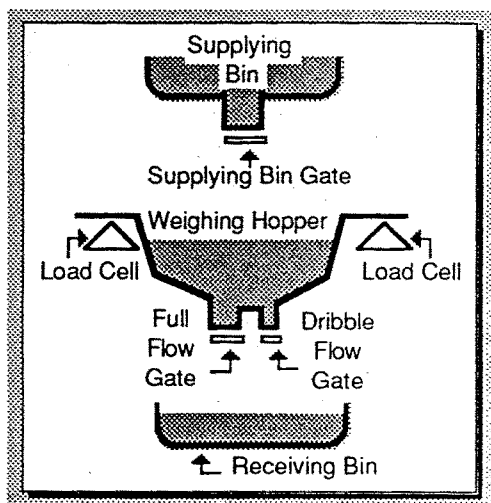

When Operator or Program appears action is performed by an operator, or the customer generated program.

- Output and Input numbers in parenthesis refer to the Control I/O 'SCREW ARRANGEMENT' table on G-2.
- The following can be connected:
  - Optional Preliminary Output (output 2) to the Supplying Bin Gate controller.
  - Preliminary Output (output 3) to the Weighing Hopper Full-Flow Gate controller.
  - Final Output (output 4) to the Weighing Hopper Dribble-Flow Gate controller.
  - Start signal Input is from input 4.

1

Start

- The Weighing Hopper is empty as is the Receiving Bin. The display shows "0", and all Gates are closed.

2

Operator or Program

- ▣ Input a Set Point Code number.
- ▣ Open the Supplying Bin Gate.

3

AD-4325A

- When the display reaches Optional Preliminary value (see 'F 12', F-11), the Optional Preliminary Output signal will be sent, or - "come ON".
- If the Gate switch control relays are connected as listed above - the Supplying Bin Gate will be closed by using the Optional Preliminary Output ON signal.



The displayed weight will exceed the Optional Preliminary value by the Free Fall value. This weight is not necessarily accurate - but accuracy is not needed here since the purpose of this event is to fill up the Weighing Hopper. The Optional Preliminary value is always compared to GROSS weight.

4

Operator or Program

- ▣ Input a TARE signal (input 2) to ZERO the display.

5

AD-4325A

- Display goes to ZERO.

**6**

**Operator or Program**

**7**

**Built-In Auto Program**

- ▶ Input the Start signal via the Control I/O interface connector (input 4).
- When the Start signal is received, the Preliminary and Final Outputs "come ON".
- ▶ The Weighing Hopper Full-Flow Gate and Weighing Hopper Dribble-Flow Gate will be opened by using the Preliminary Output and Final ON signal.

F 15 is set at "04",  
"14" or "24"

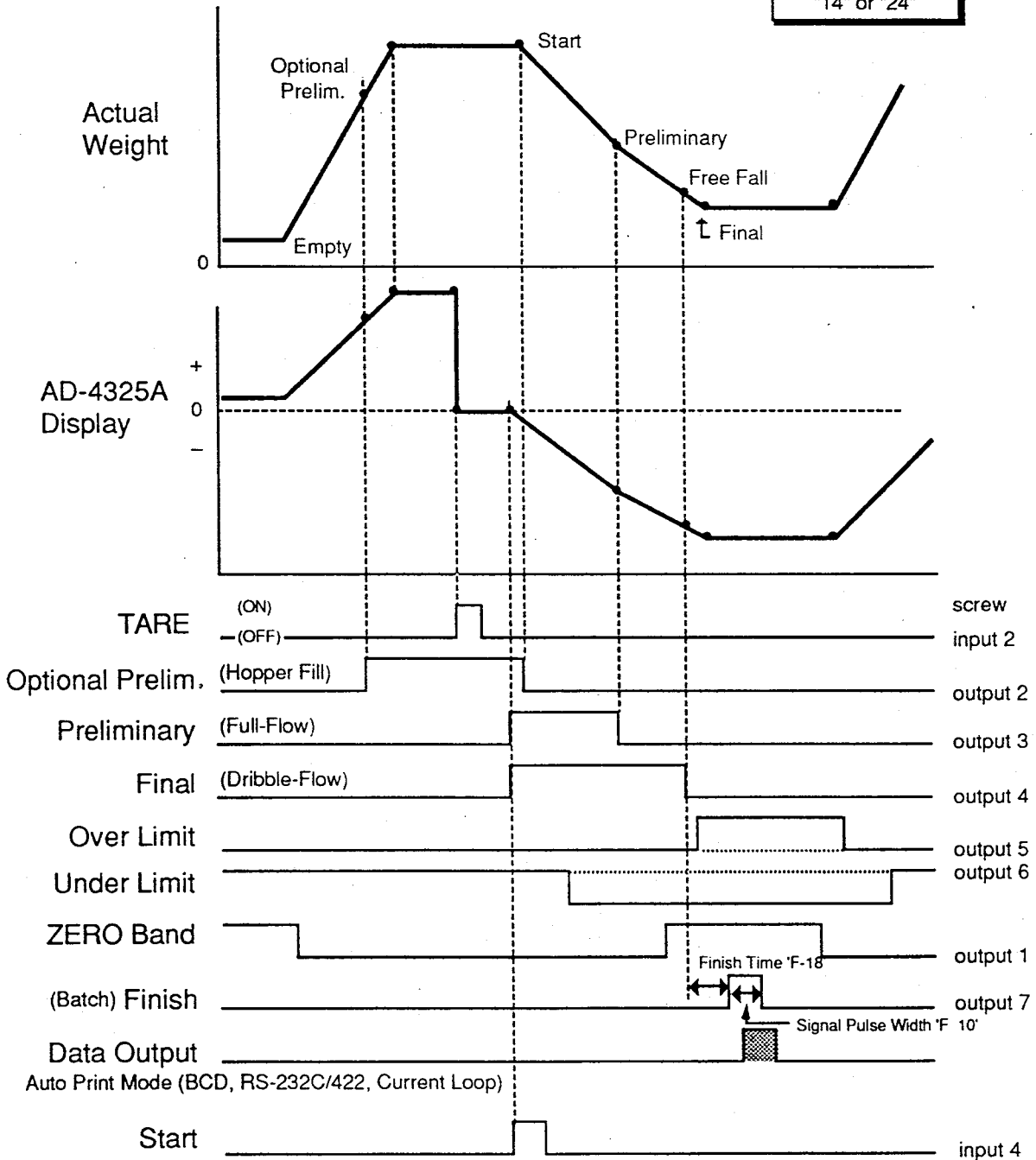



**8****AD-4325A**

- When the display reaches Preliminary (Final minus Optional Preliminary) the Preliminary Output signal will be OFF.
- The Weighing Hopper Full-Flow Gate will be closed by using the Optional Preliminary Output OFF signal.

**9****AD-4325A**

- When the display reaches Free Fall (Final minus Free Fall value) the Final Output signal will be OFF (see 'F 14', F•12)
- The Weighing Hopper Dribble-Flow Gate will be closed by using the Final Output OFF signal.

**10****Built-In Auto Program**

- Batch Finish signal is sent after the set time period (see 'F 18', F•13) or when the display is stable ('F 18' default).

**11****AD-4325A**

- After Automatic Free Fall has stopped, the display will show the Final value.

**12****Operator or Program**

- ▣ If you used Over and Under Limits – after Free Fall has stopped, check that both signals are OFF. If both outputs are OFF, then the batch is completed correctly.
- Automatic Free Fall ('F 14') is now recalculated for the next event.



If you change the Automatic Free Fall Set Point value – either from the Front Panel or the RS-232C/422 – the learned Free Fall value will be cleared.

**13****Built-In Auto Program**

- Data Output is sent (Auto Print Mode: BCD, RS-232C/422 or Current Loop). If 'F 19' is set to "2" (F•14), the Data Out totals the Net weight.
- ▣ Please use ZERO Band Output for refilling if needed.

**14****AD-4325A**

- Ready for next batching event.



If an Abort signal is sent (input 5) anytime after the Start signal is received, then:

- Optional Preliminary, Preliminary and Final signals will go OFF, and Gates will close.
- Batch Finish and Data Output signals will be sent.
- NET weight is totalled (if 'F 19' is set to "2").

During a normal batching event, do not press the **TARE** or **STNDVOPR** keys.



*Please note that the idea of Free Fall is based upon the concept of solids falling (after the flow has been cut to ZERO) from a Supplying Bin into a Weighing Hopper. When liquids are being added to a Weighing Hopper, wave propagation must be kept to a minimum to avoid load oscillation. If a submerged filling probe is employed (which may mean ZERO Free Fall) liquid displacement must be taken into consideration.*



# Multiple-Ingredient Batching



Multiple-Ingredient Batching can be done in any of the four Batch settings of F-Function 'F 15' (see **F•13**). Accumulation will be performed by Automatic Free Fall Compensation Command (Control I/O Input 5) in the Customer-Programmed Control mode and at Final Output in the Built-In Automatic Program mode (see 'F 19', **F•14**). The example below is a Normal Batching operation in the Customer Programmed Control mode.

**For this explanation the following hold true:**

- ❑ When AD-4325A appears in the left-hand column – action is performed by the AD-4325A. When Program appears action is performed by a customer-generated program and when Operator or Program appears action is performed by an operator, or the customer-generated program.

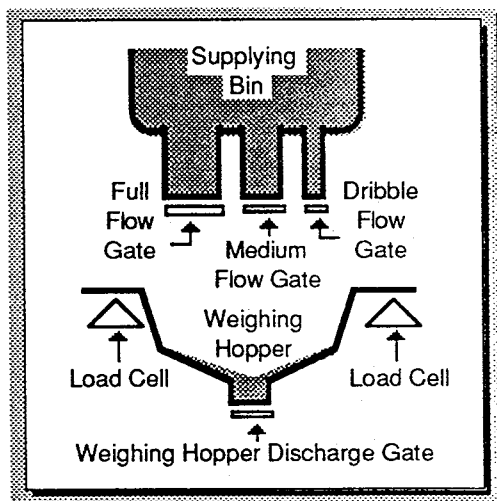

- ❑ Output and Input numbers in parenthesis refer to the Control I/O 'SCREW ARRANGEMENT' table on **G•2**.
- ❑ The following can be connected:
  - Optional Preliminary Output (output 2) to the Weighing Hopper Full-Flow Gate controller.
  - Preliminary Output (output 3) to the Medium-Flow Gate controller.
  - Final Output (output 4) to the Dribble-Flow Gate controller.

**1**

Start

- The Weighing Hopper is empty, the display shows "0", and all Gates are closed.

**2**

Operator or Program

- ▶ Input the Set Point Code number for Batching.

**3**

Operator or Program

- ▶ If the display is not at ZERO, please input a TARE or ZERO signal whichever is appropriate.

**4**

Operator or Program

- ▶ Open the Supplying Bin's: Full-Flow Gate, Medium-Flow Gate, and Dribble-Flow Gate.

**5**

AD-4325A

- When the display reaches Optional Preliminary value (see 'F 12', **F•11**), the Optional Preliminary Output signal will be sent, or - "come ON".

**6**

Program

- ▶ Close the Full-Flow Gate by using the Optional Preliminary Output ON signal.

**7****AD-4325A**

- When the display reaches Preliminary (Final minus Preliminary value) the Preliminary Output signal will be sent, or - "come ON".

**8****Program**

- ▣ Close the Medium-Flow Gate by using the Preliminary Output ON signal.

**9****AD-4325A**

- When the display reaches Free Fall (Final minus Free Fall value) the Preliminary Output signal will be sent, or - "come ON".

**10****Program**

- ▣ Close the Dribble Gate by using the Final Output ON signal.



An Automatic Free Fall Compensation Command (Min.200ms pulse input 5, **G•2**) may be given at this time.

If you change the Free Fall Set Point value (F14, **F•12**) either from the Front Panel or the RS-232C/422 – the learned Free Fall value will be cleared.

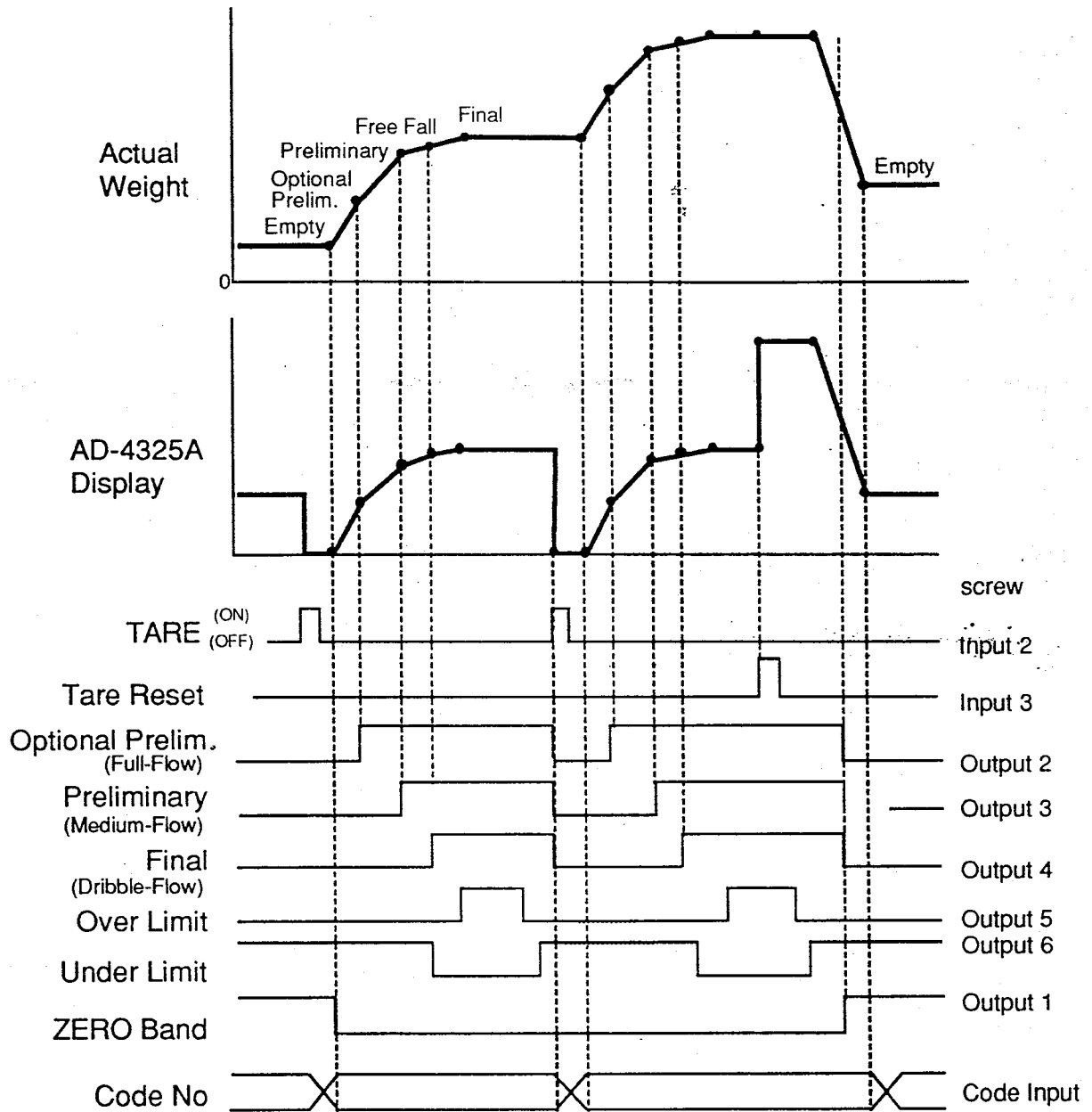

**11****Program**

- ▶ Check to see if the Over and Under Limit signals are OFF. If both outputs are OFF then the batch is completed correctly.

**12****Program**

- ▶ The AD-4325A does not have a Discharge Gate control for the Weighing Hopper - use the Final signal plus a time period as the control signal to open the Weighing Hopper Discharge Gate.

**13****AD-4325A**

- When the GROSS weight is below ZERO Band ('F 11', F•11), the ZERO Band Output will come ON - signifying the weighing Hopper is empty.

**14****Program**

- ▶ Close the Weighing Hopper Discharge Gate by using the ZERO Band Output ON signal.
- You are now ready for your next batching event.

**15****Operator or  
Program**

- ▶ Load the next substance into the Supplying Bin. Prepare the proper Program, Operator Settings (if needed). Repeat Steps #2 ~ #14.

# Standard Serial Output



The Standard Serial Connector is for a printer, remote display, or similar device. Do NOT confuse it with Option OP-04 Serial Interface. The Standard Serial Connector is marked 'SER. OUT' on the Rear Panel, and is pictured to the right. This is a passive current loop output.



## Transmission Mode

Refer to the following F-Functions to set up your Serial Out:

### FOR STANDARD CURRENT LOOP

F 21	Baud Rate	600, 2400 Baud
F 22	Output Data	Display, GROSS, NET, TARE, or GROSS+NET+TARE Data
F 23	Output Mode	Stream, Auto Print, Manual Print, Accum. Print
F 24	Output Availability	Always available or when stable only
F 25	Output Format	Sending with code, sending w/o code (see H-9)

### 'F 23' = "1" Stream Mode

In this mode data will be transmitted whenever new data becomes available. However, the sampling rate, or baud rate, is so fast that there is a possibility the output will not be the latest data. Output wave form timing is as follows:

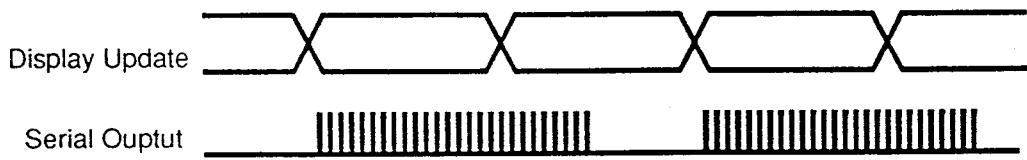

### 'F 23' = "2" Auto Print Mode

- Customer Program Control Modes:** The data is sent once when the Optional Preliminary, Preliminary, and Final Outputs have all reached (ON) and the display is stable. The Auto Print function will reset if the NET weight data falls below +5 Divisions.
- Built-in Automatic Program Control Modes:** The data is sent when the (Batch) Finish signal is sent.

## ⚡ 'F 23' = "3" Manual Print Mode

The data is sent when an I/O control input screw (input 6) is shorted to Common.

## ⚡ 'F 23' = "4" Accumulate and Print Mode

The data is sent when Accumulation totals are performed. In Customer Programmed Normal Batching Mode it is performed when an Automatic Free Fall Compensation command is input (input 5, **G•2**), and in Built-In Automatic Program Normal Batching Mode printing occurs when the Batch Finish signal is sent.

## ⚡ Pin Assignment

Pin	Assignment
1	No Connection
2	Frame Ground (GND)
3	Serial Output *
4	N. C.
5	Serial Output *
6	N. C.
7	N. C.

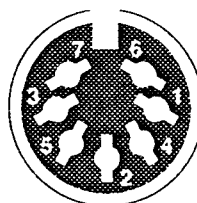

The 7 pins numbered above correspond with the pins described in the table to the left.

\* Output has no polarity, rather it is bi-directional

## ⚡ Signal Format

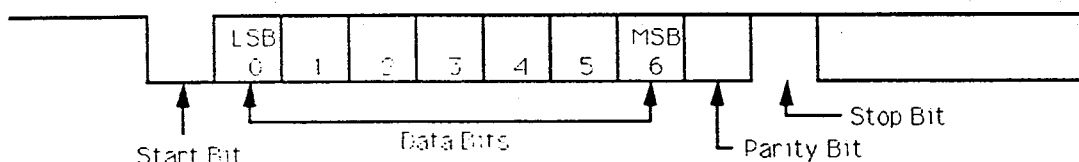

20mA Current Loop	
1 =	20mA
0 =	0mA





# Code Input Wiring Diagram

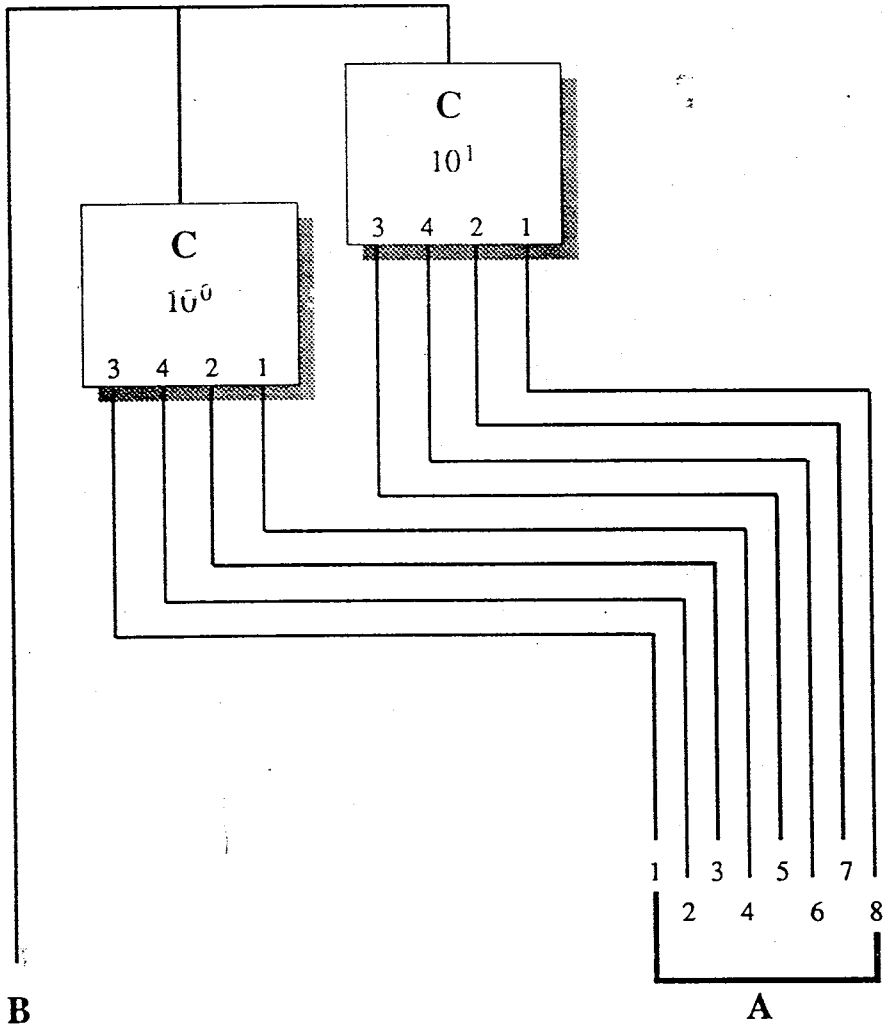

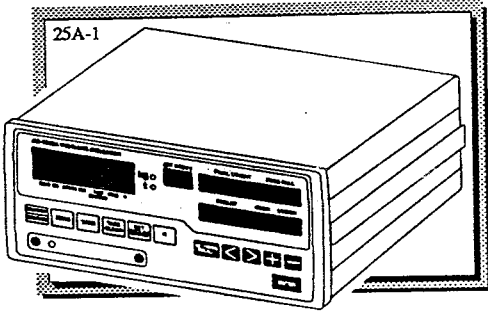

**AD-4325A • Section H**

Options



## Parallel BCD Output

# OP-01



The parallel BCD Output Connector is for sending weight data to a printer, remote display, PLC (Programmed Logic Control). It should be installed in the window marked 'Data Out' on the rear panel. The Serial Interface Connector Option (OP-03/04) may also be installed here. You may only use one or the other.

The Pin numbers of the BCD Output correspond with the Pins described in the 'PIN ASSIGNMENTS' table on the next page.

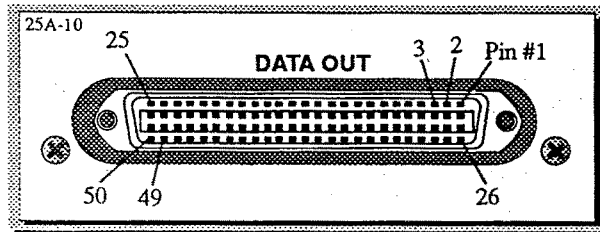

## Transmission Mode

Refer to the following F-Functions to set up your Parallel BCD Out:

### FOR PARALLEL BCD OUTPUT

F 31	Output Data	Display, GROSS, NET, or TARE Data
F 32	Output Mode	Stream, Auto Print, Manual Print, Accum. Print (same as 'F 23', see G•18, G•19 for descriptions)
F 33	Output Logic	Positive Logic, Negative Logic
F 34	Output Format	Normal, for AD-8113B, for AD-8114



## BCD Output Circuitry

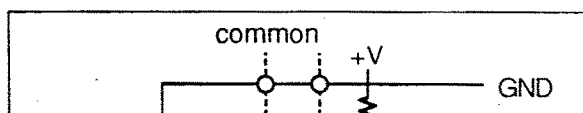

- The output circuit is an open-collector type. If you hook-up this line to TTL Logic, please



## Pin Assignments

- ❑ The BCD Output is a 50 pin connector, TTL or Open-Collector Output, fan-out 5, positive/negative logic. Pins 2 → 25 are data output.
- ❑ When BUSY (pin 50) input is accepted by a contact closure, output will go to hold and printing will be halted.

Pin	Signal	Pin	Signal
1	Ground (GND)	27	Hi = Net    Lo = Gross
2	$1 \times 10^0$	28	N. C.
3	$2 \times 10^0$	29	N. C.
4	$4 \times 10^0$	30	Print Command 2 ('F 34' is set at "2")
5	$8 \times 10^0$	31	N. C.
6	$1 \times 10^1$	32	N. C.
7	$2 \times 10^1$	33	Lo = Motion Detection
8	$4 \times 10^1$		'F 34' is set at "2" or "3"
9	$8 \times 10^1$		Not USA Ver.    USA Ver.    'F 34' is set at "1"
10	$1 \times 10^2$		34    Lo=kg, Hi=t    Lo=lb, Hi=kg $1 \times 10^0$
11	$2 \times 10^2$	35	Lo=kg, Hi=t    Lo=lb, Hi=kg $2 \times 10^0$
12	$4 \times 10^2$	36	Lo=kg, Hi=t    Lo=lb, Hi=kg $4 \times 10^0$
13	$8 \times 10^2$	37	Hi Permanently $8 \times 10^0$
14	$1 \times 10^3$	38	Lo=kg, Hi=t    Lo=lb, Hi=kg $1 \times 10^1$
15	$2 \times 10^3$	39	Hi Permanently $2 \times 10^1$
16	$4 \times 10^3$	40	Lo Permanently $4 \times 10^1$
17	$8 \times 10^3$	41	Lo=kg, Hi=t    Lo=lb, Hi=kg $8 \times 10^1$
18	$1 \times 10^4$	42	Lo = Negative Polarity
19	$2 \times 10^4$	43	Decimal Point at $10^1$
20	$4 \times 10^4$	44	Decimal Point at $10^2$
21	$8 \times 10^4$	45	Decimal Point at $10^3$
22	$1 \times 10^5$	46	Decimal Point at $10^4$
23	$2 \times 10^5$	47	Overload
24	$4 \times 10^5$	48	N. C.
25	$8 \times 10^5$	49	Print Command 1
26	N. C.	50	Busy (input)

Options

- If 'F 34' is set to "1", pins #34 ~ #41 output Set Point Code numbers.  
If 'F 34' is set to "2" or "3", pins #34 ~ #41 output Unit signals.
- If you are going to use an AD-8113B or AD-8114 printer use the KO: 145 cable supplied with the printer.
- Standard Accessory – Mating connector (1) 57-30500 (Amphenol).

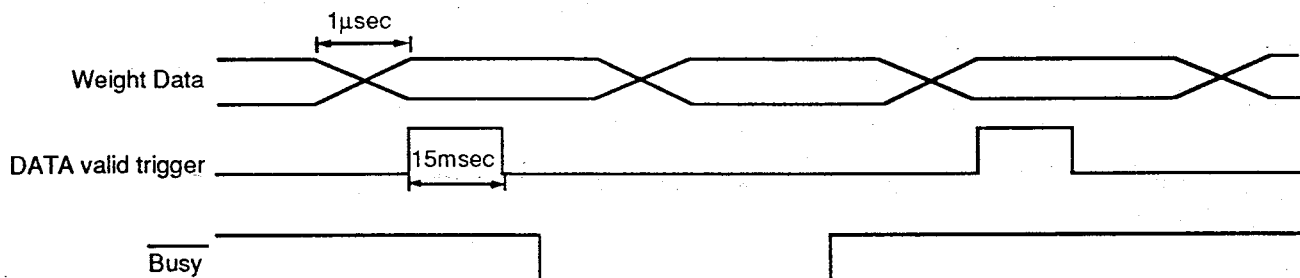



# Relay Output

# OP-02



The Outputs are isolated by Relay Outputs. If Option OP-02 is installed, the Control I/O External Interface (G•2) cannot be installed.

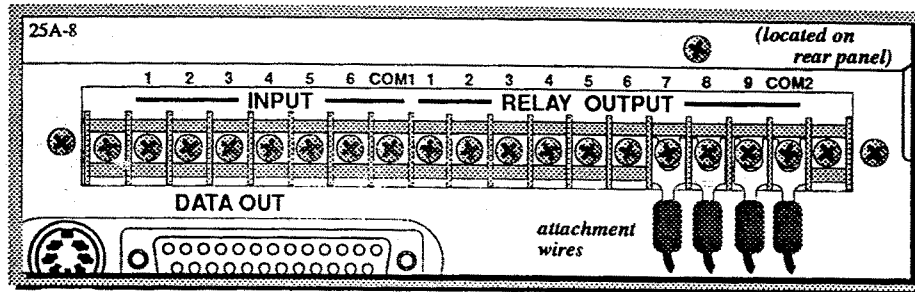

- ▶ Connect your six inputs to the screws marked 'INPUT' on the Control I/O and the nine outputs to the screws marked 'RELAY OUTPUT'. Connect the common input to 'COM1' and the common output to 'COM2'.



## Specifications

Relay Ratings	
Rated Load	240V AC, 0.5A 28V DC, 0.5 A
Minimum Load	5V DC, 10mA
Life	100,000 times or more Open/Close frequency equals 1.88 times per hour



## RS-422 Interface Option OP-03



This option is an interface to be connected to a sequencer and personal computer. The input/output standards conform to EIA-RS-422.

Prior to connection, set each function. Up to 10 interfaces can be connected in series and the maximum length of the cable is 500 m (irrespective of the number of interfaces to be connected).

### FOR SERIAL INTERFACE OPTION OP-03

F 41	10 <sup>0</sup>	Baud Rate	1200, 2400, 4800, 9600	
	10 <sup>1</sup>	Data Bit Length	7 (= ASCII), 8 (MSB = 0)	
		Stop Bit Length	1, 2	
	10 <sup>2</sup>	Parity	EVEN, ODD, without Parity	
	10 <sup>3</sup>	Terminator	CR, LF, CR	
F 42	Output Data	Without Address	Display, GROSS, NET, TARE, GROSS+NET+TARE, GROSS per Sampling, NET per Sampling	
		with Adr.	Display, GROSS, NET, TARE	
F 43	Output Mode	Without Address	Stream, Auto Print, Manual Print, Command 1, Command 2, Accum. Print	
		with Adr.	Command 1, Command 2	
F 44	Output When Over or Unstable	Sending/Not sending when over or unstable		
F 45	Output Data Format	Sending with code No. or w/o code No.		
F 46	Communication Mode	With address or w/o address		
F 47	Address No.	0~9		

## SPECIFICATIONS

- (1) Type .....EIA-RS-422
- (2) Method .....Half-duplex, Asynchronous Transmission, Bi-directional.
- (3) Format
  - Baud rate.....1200, 2400, 4800, 9800 BPS
  - Data bit .....7 (ASCII) or 8 (MSB=0)
  - Parity bit.....Even, ODD or without Parity
  - Stop bit .....1 or 2
- (4) Terminator .....  $\text{CR}$  LF,  $\text{CR}$
- (5) Output level
  - 1 .....SDA<SDB , 0 .....SDA>SDB ,  $|SDA-SDB|\approx 2V$

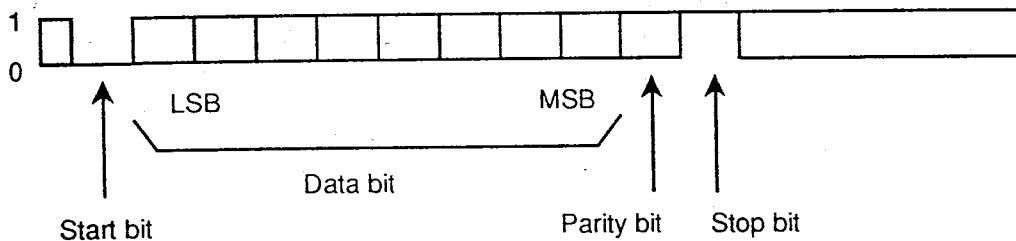

### Data Formats without Address when 'F46' = "1"

Data Formats are the same as that of OP-04.  
See page H12 ~H19 .

### Data Formats with Address when 'F46' = "2"

This can be used only with Command Mode #1 and #2.  
See page H15 ~H16 .

Before the Command, add '@' and the address No.

When you connect the AD-4325A more than 2 units, each address should be different.

The address Number is chosen out of 00 through 09.

The higher digit is fixed to 0 and the lower digit is set by F47.

Example. When you send T  $\text{CR}$  LF to the AD4325A, addressed to 01 ('F47'="1"), send the data as follows.

@ 01 T  $\text{CR}$  LF

The AD4325A, addressed to 01, will send back

@ 01 T  $\text{CR}$  LF



# Interface Circuit Diagram

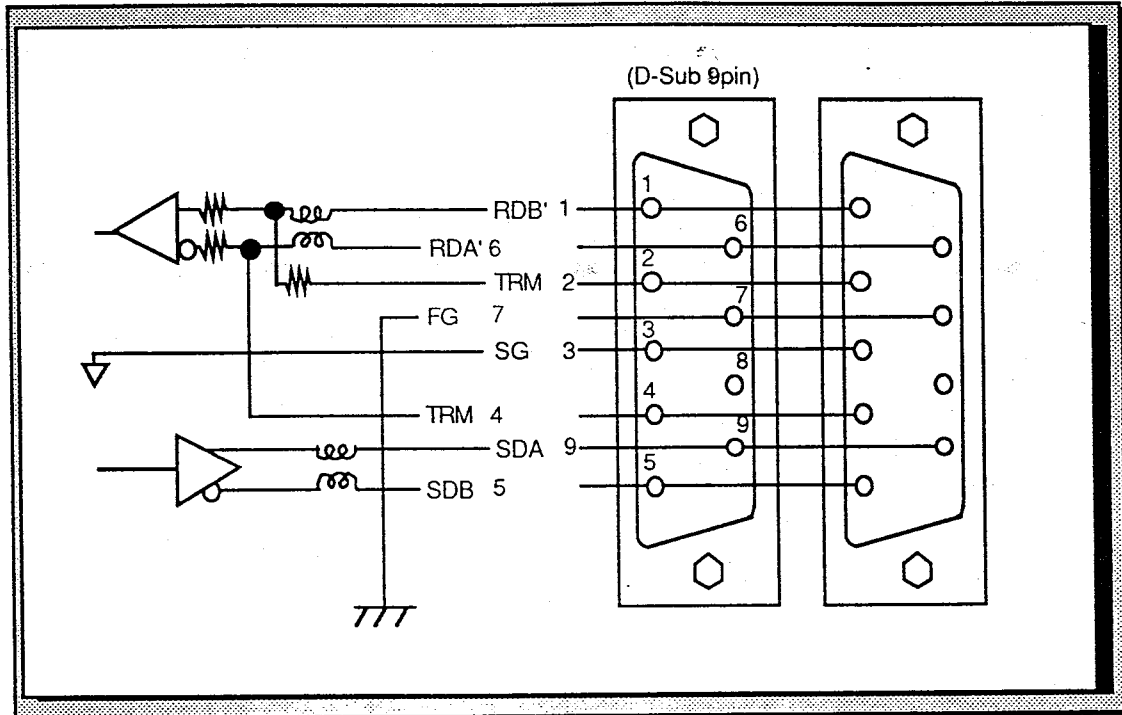

\*Short-circuit the TRM pins at the last end as viewed from the host (sequencer, etc.)  
(Short-circuit pins 2 and 4 of either one of the connectors.)

\*Pin 8 is not connected.

Example of cable connection

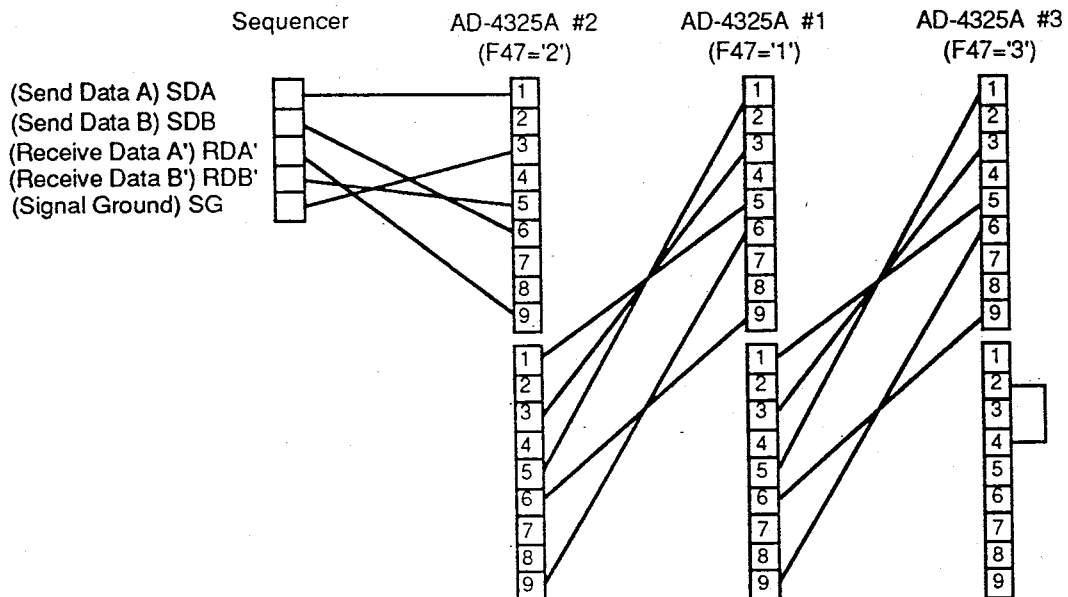



## RS-232C Interface

## OP-04



Two Connectors are provided with the RS-232C Interface Option; a Current Loop Connector and an RS-232C Connector. The 7-pin Current Loop (four of the pins are not connected however) and the 25-pin RS-232C (pins 8 → 25 are not connected) transmit the same data. Only use one of the two ports to connect a computer or other peripheral device.

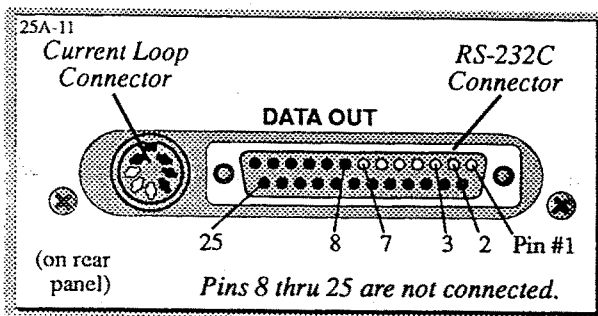

The analogue output from the Load Cell(s), and the RS-232C input/output signals, are sensitive to electrical noise. Do not place these cables together as it could result in cross-talk interference. Please also keep them well away from AC power cables. Keep all cable/coax as short as possible.



## Transmission Mode

Refer to the following F-Functions to set up your RS-232C Interface:

### FOR SERIAL INTERFACE OPTION OP-04

F 41	10 <sup>0</sup>	Baud Rate	600, 1200, 2400, 4800*, 9600*
	10 <sup>1</sup>	Data Bit Length	7 (= ASCII), 8 (MSB = 0)
		Stop Bit Length	1, 2
	10 <sup>2</sup>	Parity	EVEN, ODD, without Parity
	10 <sup>3</sup>	Terminator	cr LF, cr
F 42	Output Data	Display, GROSS, NET, TARE, GROSS+NET+TARE, Gross per Sampling, Net per Sampling	
F 43	Output Mode	Stream, Auto Print, Manual Print, Command 1, Command 2, Accum. Print	
F 44	Output Availability	Always available or when stable only	
F 45	Output Format	Sending with code, sending w/o code	

\*Not for use with Current Loop Output

## Specifications

- Type** EIA-RS-232C / Passive 20mA Current Loop
- Method** Half-duplex, Asynchronous Transmission, Bi-directional.  
Passive Current Loop is transmit only.
- Format** Baud rate: 600, 1200, 2400, 4800\* and 9600\* selectable
- Data bit** 7 (ASCII) or 8 (MSB = 0)      **Stop bit** 1 or 2
- Parity** EVEN, ODD or without Parity

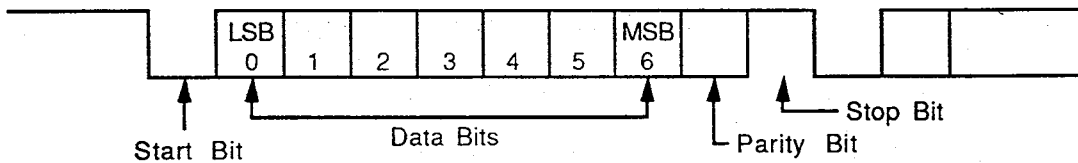

**Terminator**  LF or

- The connecting cable should be of high quality: NEC PC-8895, or Epson cable set #705, #724 are fine.

RS-232C	20mA Cur. Loop
1 = -5V → -15V	20mA
0 = +5V → +15V	0mA

## RS-232C Pin Connection

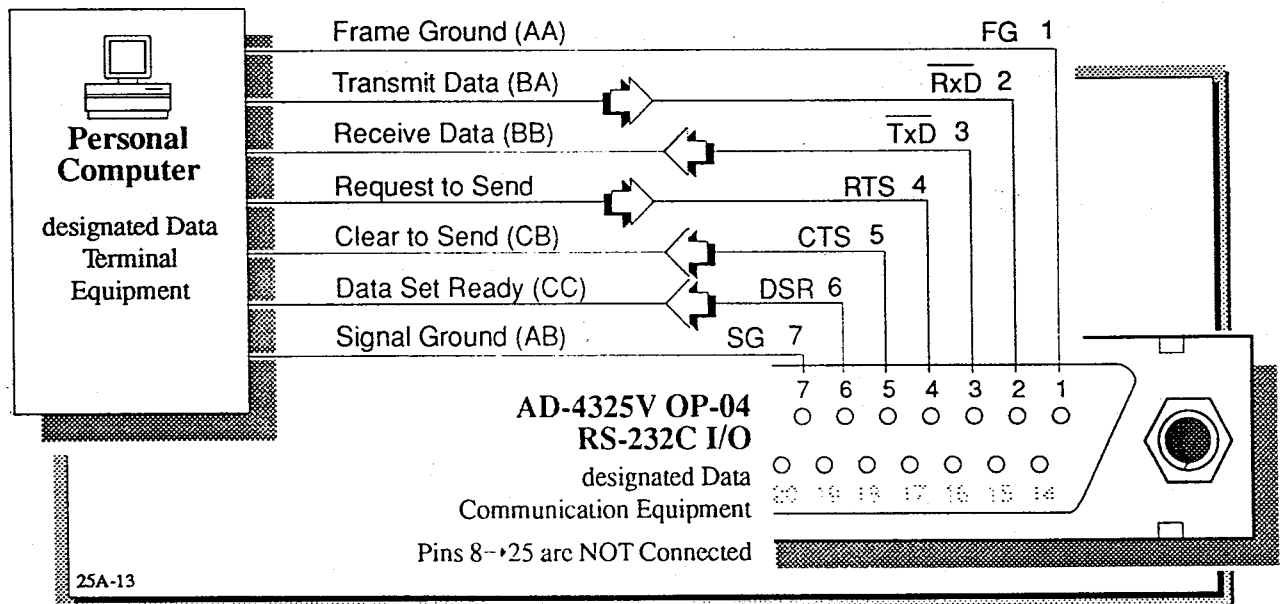

- A 25-pin RS-232C male connector and cover (HDB-25P & HDB-CTF) are not provided with this option.
- Use a high quality modem type cable between the computer and AD-4325A.

# Current Loop Pin Connection

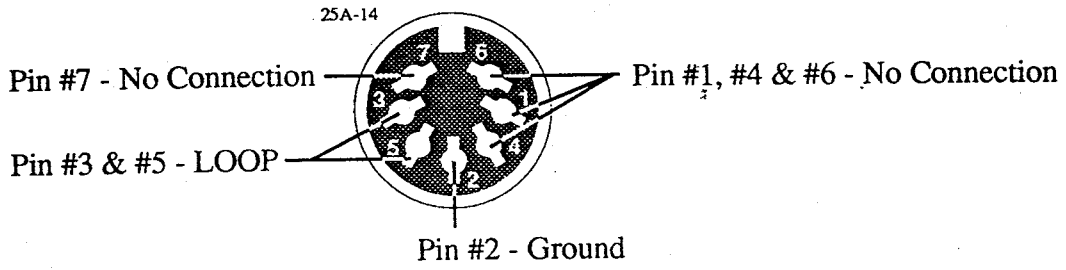

# Output Circuit Diagram

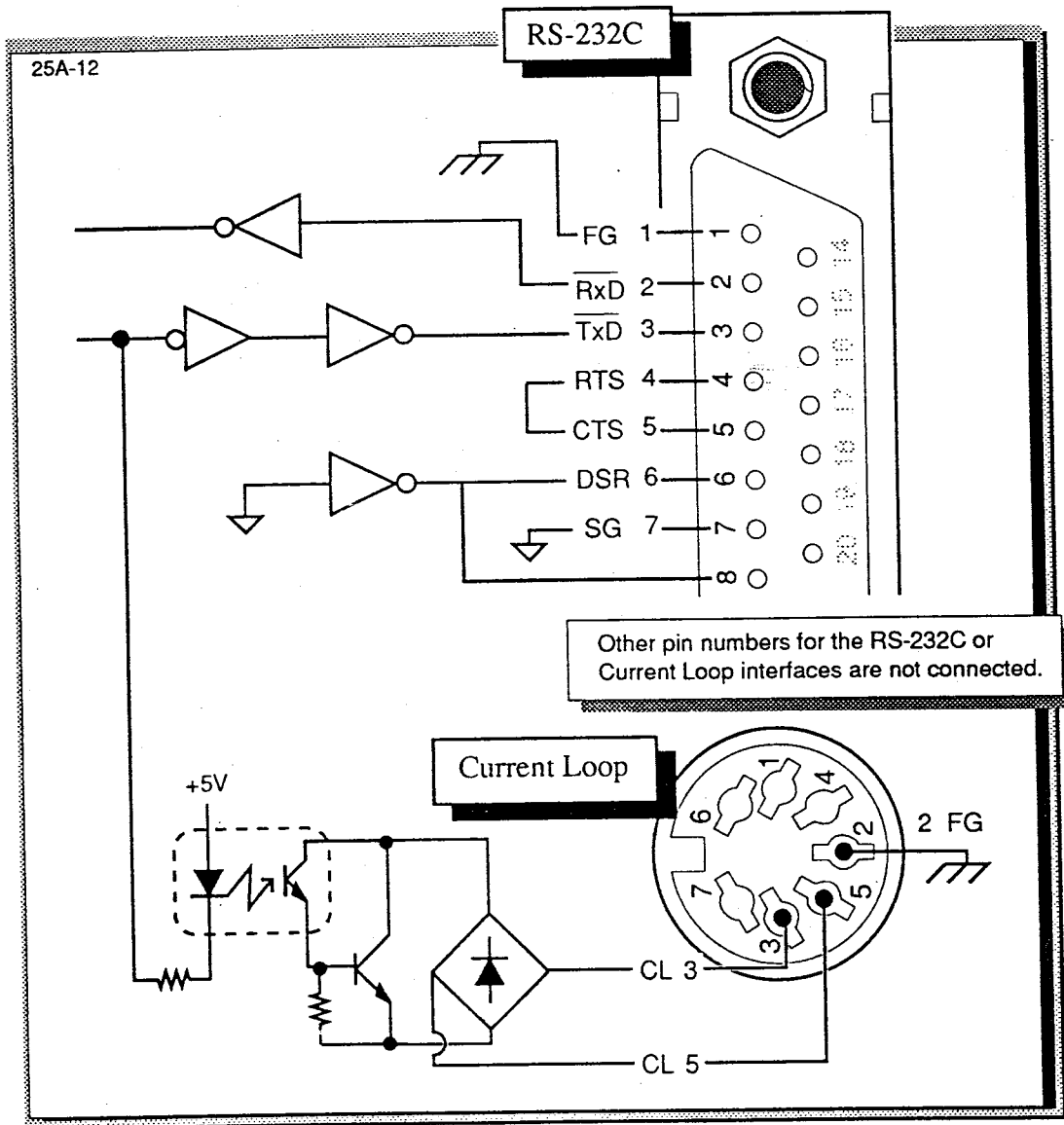



# RS-232C Data Formats



There are two Data Formats; F-Function settings dictate which format to use:

**Use Data Format #1:** When the Update Rate is slow - at 4 or 17 times per sec. ('F 42' is **NOT** set at "6" or "7"), and 'F 43' is **NOT** set to a Command Mode ('F 43' is **NOT** set at "4" or "5").

**Use Data Format #2:** When the Update Rate is fast - at 70 times per sec. ('F 42' is set at "6" or "7").



## Formatting Example

*Data Format #1, when 'F 45' is set to "1"*

C	D	,	0	.	1	,	S	T	,	N	T	,	0	0	2	4	7	8	.	1	k	g	↵	LF
↵	↵		↵	↵			↵	↵		↵	↵		↵ Data to the Main display ↵								↵	↵		
CODE	Set Point Code No.		Header 1		Header 2		("↵" represents blank space)															Indicator	Terminator	
	SET POINTS						AD-4325A WEIGHING INDICATOR																	
	01						2478.1																	



## Header 1

Overload	O	L	Data at Overload is ±9999999 for Data Format #1 and ±999999 for Data Format #2.
Stable overload (STABLE)	S	T	
Unstable overload (UNSTABLE)	U	S	



## Header 2

NET Weight (NET)	N	T	If 'F 45' is set at "5" - GROSS, NET, and TARE Data mode - the Code number is output only when the GROSS Weight is output.
GROSS Weight (GROSS)	G	S	
TARE Weight (TARE)	T	R	

## Unit Indicator

Kilogram (kg)

k	g
l	b
(20H)	t

Pound (lb)

Tonne (t)

'lb' can be used with the lb/kg version (USA) only.

't' can be used with the International version only. Be sure to include a space, see 'HEX CODE INPUTS', H-13.

## HEX Code Inputs

Space, " " - 20 (HEX)

Decimal Point, "." - 2E (HEX)

Minus, "-" - 2D (HEX)

Plus, "+" - 2B (HEX)

(20H)
(2EH)
(2DH)
(2BH)

Be sure to enter the correct HEX code when inputting data.

## Data Format #1

- When 'F 45' or 'F 25' is set to "1"

### Output with code number

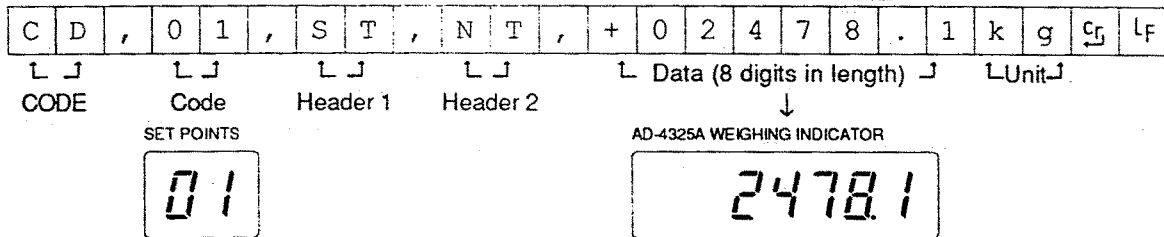

- The above line of data will be sent with Set Point Code No. 01 and a stable NET weight of 2478.1kg. The NET (▼NET) annunciator will be on with an NT in Header 2, and the kilogram annunciator will be lit as the unit of measure.

- When 'F 45' or 'F 25' is set to "2"

### Output with no code number

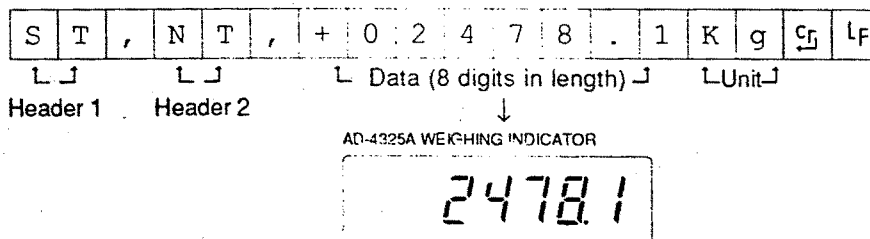

- When F45 is set to 2 and a stable, net weight of 2478.1 Kg is displayed, the above data will be output.

**Data Format #2**

when 'F 42' = "6" or "7"

**Data Format is Fixed**

+	0	7	2	9	6	6	CF	LF
---	---	---	---	---	---	---	----	----

└ Data (7 digits in length, ┘  
but decimal point not included)

AD-4325A WEIGHING INDICATOR

- ▶ In Format #2 the settings at F-Functions, 'F 41', 'F 43' and 'F 44' will be ignored; they will automatically be set to "1". The Baud Rate will be fixed at 9600bps, printing will be in Stream mode and output will always be available. The data is sent in 7 digits with no Header 1 or Header 2 data, no unit indicator and no decimal point.

- **OUTPUT MODES**

**'F 43' = "1" Stream Mode**

In this mode data will be transmitted whenever new data becomes available. However, the sampling rate, or baud rate, can be so fast that there is a possibility the output will not be the latest data. Output wave form timing is as follows:

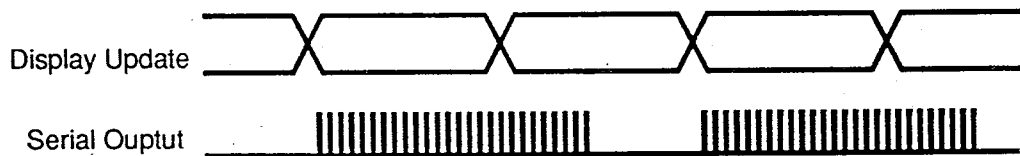
**'F 43' = "2" Auto Print Mode**

- **Customer Program Control Modes:** The data is sent once when the Optional Preliminary, Preliminary, and Final Outputs have all reached (ON) and the display is stable. The Auto Print function will reset if the NET weight data falls below +5 Divisions.
- **Built-in Automatic Program Control Modes:** The data is sent when the (Batch) Finish signal is sent.

**'F 43' = "3" Manual Print Mode**

The data is sent when an I/O control input screw (input 6) is shorted to Common.

## 'F 43' = "4" Command Mode #1



When F-Function 'F 43' Command Mode #1 is selected ('F 43' is set to "4"), a command will be sent from the host computer or sequencer to the AD-4325A. The AD-4325A will send back a reply to the Host according to the command.

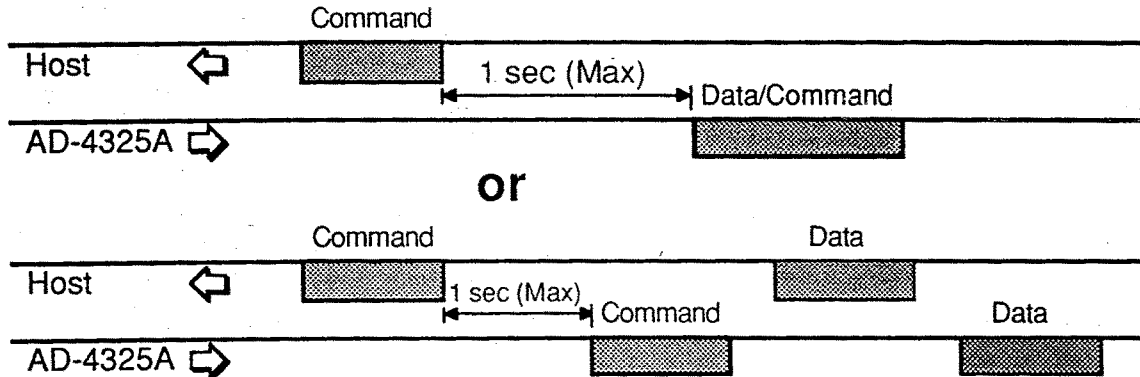

## Command List Table

To AD-4325A	Command from Host	AD-4325A Response
R(W) $\text{CR}$ LF •READ•	This is a command to the AD-4325A to read the data and transmit.	If "R(W)" is received, the AD-4325A will send the latest data one time. Data format depends on 'F 42' & 'F 45'
(M)Z $\text{CR}$ LF •ZERO•	This is a command to the AD-4325A to ZERO the display.	If "(M)Z" is received, the AD-4325A display will ZERO and: (M)Z $\text{CR}$ LF will be sent by the AD-4325A.
(M)T $\text{CR}$ LF •TARE•	This is a command to the AD-4325A to TARE the display and go to NET mode.	If "(M)T" is received, AD-4325A will go to NET mode, display will ZERO, TARE ENTERED annunciator will be lit and: (M)T $\text{CR}$ LF will be sent by the AD-4325A.
(M)N $\text{CR}$ LF •NET•	This is a command to the AD-4325A to change from GROSS to NET mode.	If "(M)N" is received, AD-4325A display will change from GROSS to NET mode and: (M)N $\text{CR}$ LF will be sent by the AD-4325A.
(M)G $\text{CR}$ LF •GROSS•	This is a command to the AD-4325A to change from NET to GROSS mode.	If "(M)G" is received, AD-4325A display will change from NET to GROSS mode and: (M)G $\text{CR}$ LF will be sent by the AD-4325A.

- The number in parenthesis is optional, both one letter and two letter inputs can be entered.











The Command Mode #1 can only work with the RS-232C or RS-422 Connector.

- ▣ If the commands are not accepted for any reason: I  $\text{CR}$  LF will be sent by the AD-4325A.
- ▣ If an invalid character is received: ?  $\text{CR}$  LF will be sent by the AD-4325A.



**'F 43' = "5" Command Mode #2**
**Command List Table**

To AD-4325A	Command from Host	Setpoint Data from Host (2nd Command)
<b>BB</b>  • <u>B</u> EGIN <u>B</u> ATCHING•	This is a command to the AD-4325A to begin Batch Weighing.	"BB" can only be received in the Built-in Automatic Program Control mode.
<b>HB</b>  • <u>H</u> ALT <u>B</u> ATCHING•	This is a command to the AD-4325A to halt Batch Weighing.	"HB" can only be received in the Built-in Automatic Program Control mode.
<b>RF</b>  • <u>R</u> EADS <u>F</u> INAL NET•	This is a command to the AD-4325A to read the final NET weight.	"RF" can only be received in the Built-in Automatic Program Control mode. Data Format depends on 'F 45' setting.
<b>S</b>  • <u>S</u> ETPOINT	This is a command to the AD-4325A to accept Set Point data for the current Code setting.	If "S" is received, the Host will send the Final Weight, Free Fall, Preliminary Output, Over, Under, Optional Preliminary and ZERO Band.
<b>SS XX</b>  • <u>S</u> ET <u>S</u> ET POINTS•	This is a command to the AD-4325A to accept Set Point data for "xx", the Code setting.	If "SSxx" is received, the Host will send the Final Weight, Free Fall, Preliminary Output, Over and Under Weight.
<b>RS XX</b>  • <u>R</u> EAD <u>S</u> ET POINTS•	This is a command to the AD-4325A to read Set Point data for "xx", the Code setting.	If "RSxx" is received, the Host will read the Final Weight, Free Fall, Preliminary Output, Over and Under Weight.
<b>SA</b>  • <u>S</u> ET <u>A</u> CCES- <u>S</u> ORIES•	This is a command to the AD-4325A to accept the Optional Preliminary Output and ZERO Band.	If "SA" is received, the Host will send the Optional Preliminary Output ('F 12') and ZERO Band ('F 11'), changing the current F-Function settings.
<b>RA</b>  • <u>R</u> EAD <u>A</u> CCES- <u>S</u> ORIES•	This is a command to the AD-4325A to read the Optional Preliminary Output and ZERO Band.	If "RA" is received, the Host will read the Optional Preliminary Output ('F 12') and ZERO Band ('F 11').
<b>CC XX</b>  • <u>C</u> ODE <u>C</u> HANGE•	This is a command to the AD-4325A to change the Code setting to "xx".	Set the F-Function ('F 15' to "21" ~ "24") on the AD-4325A for use with the RS-232C or RS-422.

In place of "XX", enter a code number. If you type in two blank spaces the current code number will be used; this is also true for Command "S". **Exception:** in Built-in Automatic Program mode the reserved code number will be used when not weighing (see 'F 19', F-14).

In addition to these Commands listed, those described in the Command List Table for Command Mode #1 also apply.



**The Command Mode #2 can only work with the RS-232C or RS-422 Connector.**

- ▶ If an invalid character is received, ?  $\text{CR}$  LF will be sent.
- ▶ If an invalid character is received for S  $\text{CR}$  LF, SSxx  $\text{CR}$  LF or SA  $\text{CR}$  LF: E  $\text{CR}$  LF will be sent.
- ▶ B  $\text{CR}$  LF will be sent by the AD-4325A when BB  $\text{CR}$  LF and RF  $\text{CR}$  LF commands are received while in the Built-in Automatic Program Mode ('F 15' = "23" or "24", F-13).
- ▶ I  $\text{CR}$  LF will be sent when HB  $\text{CR}$  LF is received while in the Built-in Automatic Program Mode ('F 15' = "23" or "24", F-13) and NOT in operation.



When F-Function 'F 43' Command Mode #2 is selected ('F 43' is set to "5"), a command will be sent from a host computer or sequencer to the AD-4325A. The AD-4325A will echo that command back and the Host will reply with Set Point information if applicable.

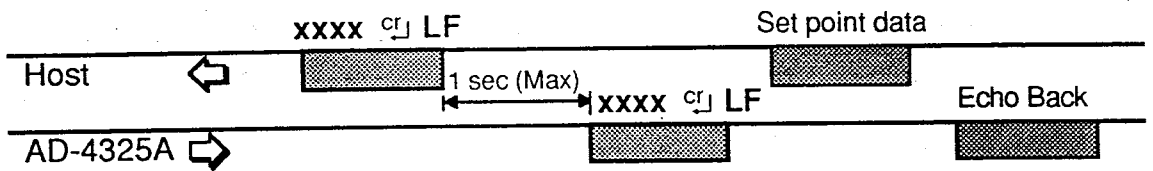

"xxxx" is the Command code entered

- If 'F 15' is set at "21" or "22", then the External I/O Input 4 screw should be open.
- ▶ Each Set Point value has 6 digits, except for the 2-digit code setting, followed by a carriage return and line feed. There are no decimal points or separators.

**Example of Set Point Data Format**

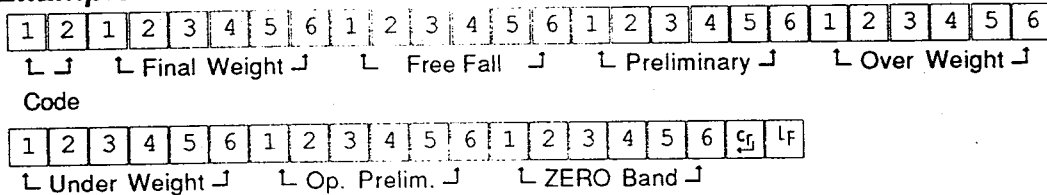

**Commands in which Set Point data is applicable are:**

**Set Point Data Format for S  $\text{CR}$  LF**

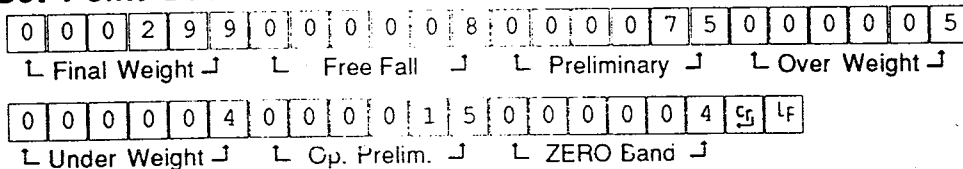

Final Weight	-	299		Under Weight	-	4
Free Fall	-	8		Optional Preliminary	-	15
Preliminary Weight	-	75		ZERO Band	-	4
Over Weight	-	5				

**Set Point Data Format for SSxx <sup>CF</sup> LF**

0	0	0	2	9	9	0	0	0	0	0	8	0	0	0	0	7	5	0	0	0	0	0	5
---	---	---	---	---	---	---	---	---	---	---	---	---	---	---	---	---	---	---	---	---	---	---	---

↓ Final Weight ↓    ↓ Free Fall ↓    ↓ Preliminary ↓    ↓ Over Weight ↓

0	0	0	0	0	4	<sup>CF</sup>	LF
---	---	---	---	---	---	---------------	----

↓ Under Weight ↓

Final Weight	-	299	Over Weight	-	5
Free Fall	-	8	Under Weight	-	4
Preliminary Weight	-	75			

**Set Point Data Format for RSxx <sup>CF</sup> LF**

0	1	0	0	0	2	9	9	0	0	0	0	0	8	0	0	0	0	7	5	0	0	0	0	0	5
---	---	---	---	---	---	---	---	---	---	---	---	---	---	---	---	---	---	---	---	---	---	---	---	---	---

↓ ↓    ↓ Final Weight ↓    ↓ Free Fall ↓    ↓ Preliminary ↓    ↓ Over Weight ↓

Code

0	0	0	0	0	4	<sup>CF</sup>	LF
---	---	---	---	---	---	---------------	----

↓ Under Weight ↓

Code number	-	1	Preliminary Weight	-	75
Final Weight	-	299	Over Weight	-	5
Free Fall	-	8	Under Weight	-	4

**Set Point Data Format for SA <sup>CF</sup> LF**

0	0	0	0	1	5	0	0	0	0	0	4	<sup>CF</sup>	LF
---	---	---	---	---	---	---	---	---	---	---	---	---------------	----

↓ Op. Prelim. ↓    ↓ ZERO Band ↓

Optional Preliminary	-	15	ZERO Band	-	4
----------------------	---	----	-----------	---	---

**Set Point Data Format for RA <sup>CF</sup> LF**

0	0	0	0	1	5	0	0	0	0	0	4	<sup>CF</sup>	LF
---	---	---	---	---	---	---	---	---	---	---	---	---------------	----

↓ Op. Prelim. ↓    ↓ ZERO Band ↓

Optional Preliminary	-	15	ZERO Band	-	4
----------------------	---	----	-----------	---	---



## 'F 43' = "6" Accumulate and Print Mode

The displayed data is sent when Accumulation totals are performed. In Customer Programmed Normal Batching Mode it is performed when an Automatic Free Fall Compensation command (input 5, **G•2**) is given in the Customer Program Control Modes step #10, **G•6** ), and in Built-In Automatic Program Normal Batching Mode printing occurs when the Batch Finish signal is sent (Step #8 in 'TIMING - NORMAL BATCHING, *Built-In Autor Program Mode*', **G•12**).

```

10 REM *****
20 REM *      AD-4325-04 INTERFACE SAMPLE PROGRAM      *
30 REM *      (COMMAND MODE)                          *
40 REM *
50 REM *      for IBM PC-XT DOS version 3.10          *
60 REM *      and BASIC VERSION D#.10                *
70 REM *
80 REM *      by A & D COMPANY, LTD.                  *
90 REM *****
100 PRINT"***** TURN ON CAPS LOCK*****"
110 PRINT"THIS PROGRAM WILL ESCAPE AFTER Q INPUTS"
120 PRINT"THIS PROGRAM MAY RETURN LAST COMMAND"
130 PRINT"SET AD4325 TO F41=3 AND F43=5"
150 OPEN "COM1:2400,,,,LF" AS #1
170 INPUT "INPUT CHARACTER(S) >>";KY$
180 IF KY$="Q" THEN GOTO 260
210 PRINT #1,KY$
220 REM
230 LINE INPUT #1,DT$
240 PRINT DT$
250 GOTO 170
260 CLOSE #1
280 END

```



## Analog Output

# OP-07



The Analog Output Option is used to transmit analog weight data to equipment that is controlled by analog signals rather than digital. A coaxial cable connector is used to output the data.

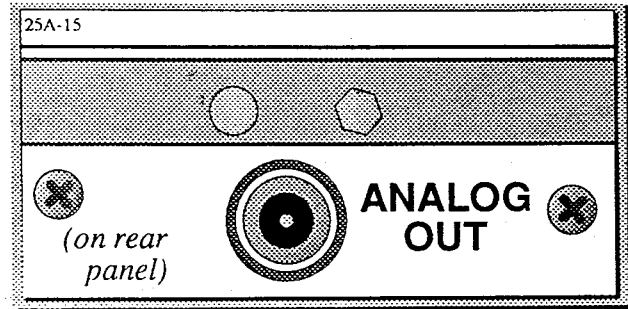

## Transmission Mode

Refer to the following F-Functions to set up the Analog Output:

### FOR ANALOG OPTION OP-07

F 5 1	Analog Output Data	Display, GROSS, or NET Data
F 5 2	Output current at display ZERO	0.0mA through 99.9mA
F 5 3	Output current at Full Scale	0.0mA through 99.9mA



## Specifications

Output Level	4 ~ 20mA effective range. Output range is approximately 2mA to 22mA.
Resolution	more than 1/1000
Temperature Coefficient	$\pm (0.015\% \text{ of rdg} + 0.01\text{mA}) / ^\circ\text{C}$
Maximum Load Resistor	500 $\Omega$ Maximum

- The Output Current when the display is at "0", and at Maximum Capacity, can be set from 0.0mA to 99.9mA by F-Functions 'F-52' & 'F-53', see G-9.
- If the output is NET output and the weighing mode is in Loss-in-Weight mode, the Analog output will send the reversed value.

## Output Circuitry

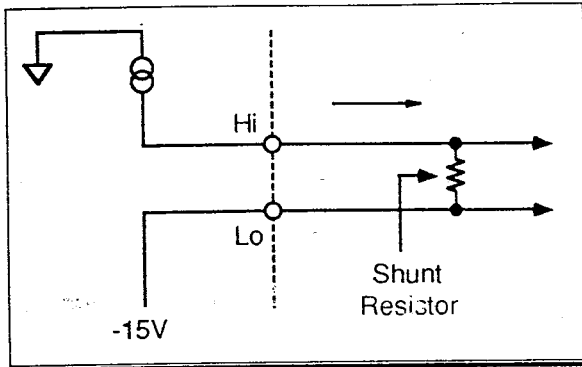

- If you add a 250Ω resistor, the output will be 1V to 5V.



Do not connect any ground line, chassis GND, or similar device.



This resistor must be large enough for proper power consumption. Use the following formula:

$$W = i^2 R \quad \text{where} \quad \begin{array}{l} W = \text{power} \\ i = \text{Output Current} \\ R = \text{Resistor} \end{array}$$

If a 500Ω resistor is used, power consumption will be:

$$W = (0.02)^2 \times 500 = 0.2 \quad \text{when the Output Current is set to 0.2mA.}$$

The resistor should have a power greater than "0.5" ( $W = 0.5$ ) and have a very low temperature coefficient. In this example power consumption is "0.2" and thus, the 500Ω resistor is adequate.

## F 53 – Setting Output Current

Output Current can be scaled from ZERO to Full Capacity by using F-Functions 'F 52' and 'F 53'. The setting range is 0.0mA to 99.9mA, at 0.1mA intervals. This simulated value is calculated by the following formula:

$$I_{OUT} = I_Z + \frac{\text{weight}}{\text{capacity}} \times (I_M - I_Z) \quad (\text{if } 2\text{mA} \leq I_{OUT} \leq 22\text{mA})$$

where  $I_{OUT}$  = Output Current  
 where  $I_Z$  = Output at ZERO ('F 52', F•19)  
 where  $I_M$  = Output at Maximum Capacity ('F 53', F•19)

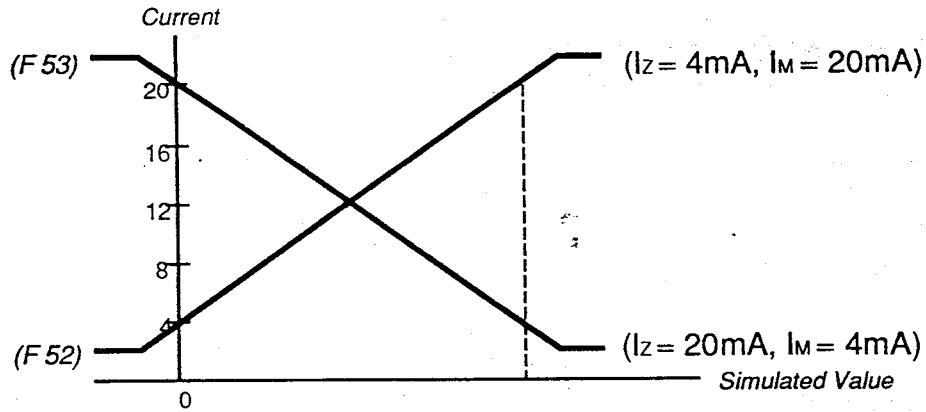

**Example:**

A weighing system has a Maximum Capacity of 10,000kg. If you want the Output current to be 4mA at ZERO display, and 20mA at 1/2 Maximum Capacity then:

$$I_M = \frac{\text{capacity}}{\text{simulated value}} \times (I_{OUT} - I_z) + I_z$$

$$I_M = \frac{10,000\text{kg}}{5,000\text{kg}} \times (20\text{mA} - 4\text{mA}) + 4\text{mA}$$

$$= 36\text{mA}$$

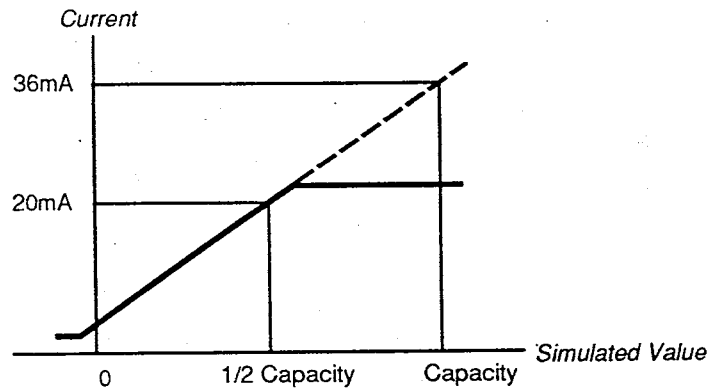

When Output at Full Scale ('F 53') is set at 36mA, and Output Current at Display ZERO ('F 52') is set at 4mA, then at 1/2 Capacity (5,000kg) the Output Current will be 20mA. **NOTE:** The Maximum Output will be saturated at 22mA.

**Analog Connector (Accessory)**

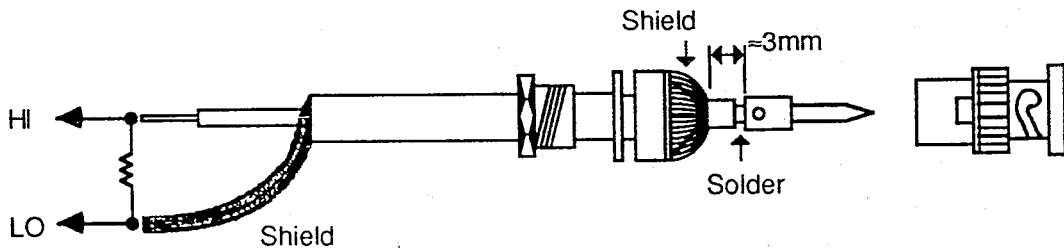

Connector is BNC type plug: **BNC-P-58U**



# Dimensions

### Rear Panel

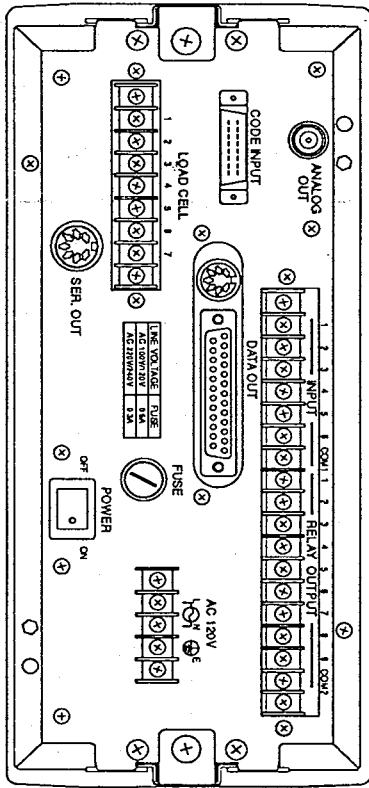

### Front Panel

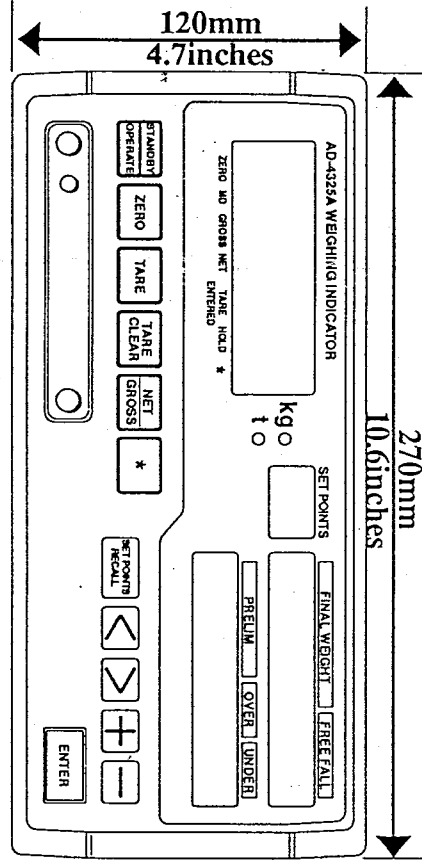

### For Mounting

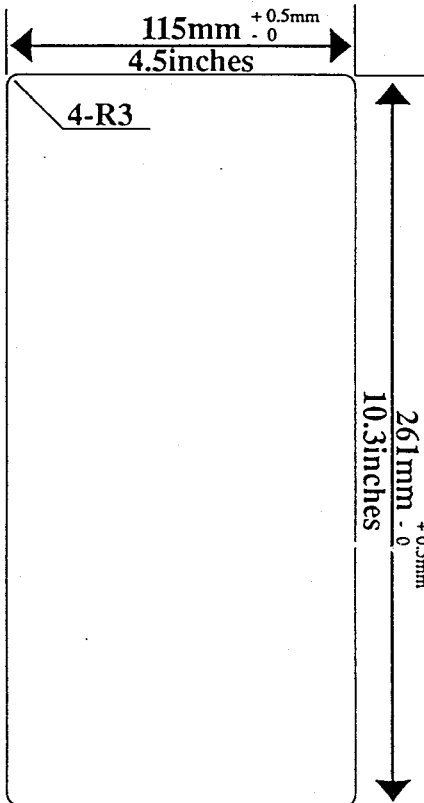

### Side View

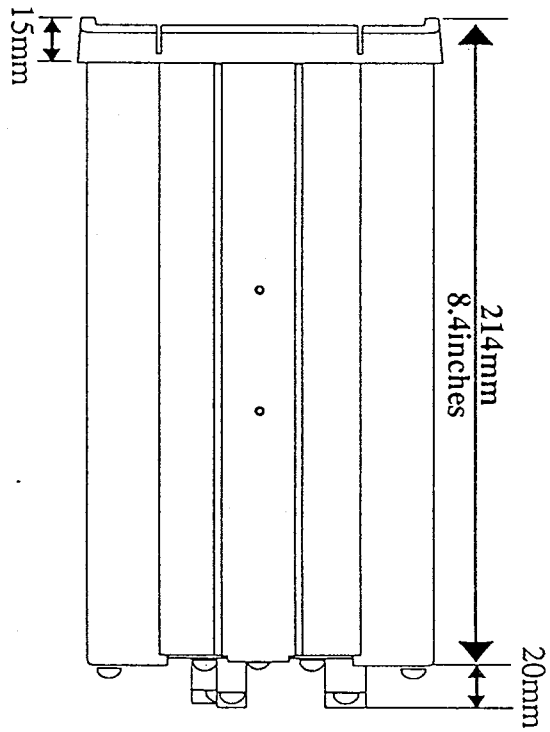







**A&D Company, Limited**

3-23-14 Higashi-Ikebukuro, Toshima-ku, Tokyo 170 Japan  
Telephone:(03)5391-6132 Fax:(03)5391-6129 Telex:2422816 AANDD J

**A&D ENGINEERING, INC.**

1555 McCandless Drive, Milpitas, CA. 95035 U.S.A.  
Telephone:(408)263-5333 Fax:(408)263-0119

**A&D INSTRUMENTS GmbH**

Lyoner Straße 36, D-6000 Frankfurt/Main 71 F.R. Germany  
Telephone:(069)666-7006 Fax:(069)666-6831 Telex:417-0586 ANDI D

**A&D MERCURY PTY. LTD.**

32 Dew Street, Thebarton, South Australia 5031 Australia  
Telephone:(08)352-3033 Fax:(08)352-7409

**A&D KOREA Limited**

3rd Floor Hanam Bldg 44-27 Yoido-dong Youngdeungpo-ku Seoul, Korea  
Telephone:(02)784-4264 Fax:(02)784-6557