

AD-4324

WEIGHING INDICATOR

INSTRUCTION MANUAL

Instruction-AD-4324-v.1.b 92.05.15. OGA

CHECK WEIGHING INDICATOR



Table of Contents

Section A • Introduction	page A • 1
Compliance with FCC Rules	page A • 2
Welcome	page A • 3
Features	page A • 3
Front Panel Description	page A • 4
Main Display.....	page A • 4
System Operation Keys.....	page A • 6
TARGET, LOWER and UPPER LIMITS Section.....	page A • 7
Acceptance Judgement Section.....	page A • 8
Dip-Switches.....	page A • 9
Rear Panel Description.....	page A • 10
AC Power Input.....	page A • 10
POWER Switch.....	page A • 10
LOAD CELL.....	page A • 10
CONTROL I/O	page A • 10
SER. OUT • Serial Output	page A • 10
DATA OUT • Option OP•01 or OP-04 Output.....	page A • 11
FUSE.....	page A • 11
Specifications	page A • 12
Section B • Installation	page B • 1
Unpacking & Setting Up.....	page B • 2
Best Conditions for Use.....	page B • 3
Connecting the Load Cell	page B • 4
Load Cell and Input Sensitivity.....	page B • 4
Select Check Weigh Mode	page B • 5
To Set Check Mode	page B • 5
Display Resolution Table	page B • 6
Section C • Calibration	page C • 1
Calibration Terms	page C • 2
If You Want to Perform.....	page C • 3
Calibration Flowchart.....	page C • 4
Full Calibration Procedure.....	page C • 5
ZERO Cal & Fine SPAN.....	page C • 9
Calibration Errors.....	page C • 10
Timer Setting Procedure	page C • 13

Compensation of Weight.....	page C • 14
F13 Setting	page C • 14
Section D • Check Mode	page D • 1
Check Weighing Operation.....	page D • 2
The STOP MODE.....	page D • 2
The RUN MODE.....	page D • 2
Check Mode 0.....	page D • 3
Check Mode 1.....	page D • 3
Check Mode 2.....	page D • 3
Check Mode 3.....	page D • 3
Check Mode 4.....	page D • 3
Check Mode 5.....	page D • 3
Checking Modes Overview.....	page D • 4
CHECK MODE–0 • Fully Automated System.....	page D • 4
CHECK MODE–1 • Semi-Automated System.....	page D • 4
CHECK MODE–2 • Fully Automated System.....	page D • 5
CHECK MODE–3 • Semi-Automated System.....	page D • 5
CHECK MODE–4 • Packing.....	page D • 6
CHECK MODE–5 • UNDER / ACCEPT / OVER.....	page D • 6
ERROR DESCRIPTION.....	page D • 7
Section E • Code Setting	page E • 1
About Code Setting Displays.....	page E • 2
Code Setting Procedure.....	page E • 2
To Set Tare Value for Each Code Number.....	page E • 3
Section F • F-Functions	page F • 1
Internal Parameter F-Functions.....	page F • 2
Changing the F-Functions.....	page F • 3
F-Function NOTES.....	page F • 4
F-Functions List.....	page F • 5
F-Functions.....	page F • 7
F-Functions 1 to 7.....	page F • 7
F-Functions 01 to 33.....	page F • 10
For the Standard Serial Output (SER. OUT).....	page F • 17
Timer Judgement.....	page F • 18
For Parallel BCD Output - Option OP-01.....	page F • 18
RS-232C, Current Loop Output — OP-04.....	page F • 18

Section G • Control I/O
Standard Serial Output..... page G • 1

CONTROL I/O..... page G • 2
 Input page G • 2
 Output page G • 2
 Circuits..... page G • 3
Serial Output (SER. OUT) page G • 4
 Specifications..... page G • 4
 Controlling F-Functions..... page G • 5

Section H • Options..... page H • 1

OP-01 Parallel BCD Output page H • 2
 Pin Assignment..... page H • 2
 BCD Output Circuit..... page H • 3
 Hold Input..... page H • 3
 Controlling F-Function page H • 3
OP-02 Relay Output..... page H • 4
 Input / Output Specification..... page H • 4
 Connection page H • 7
 OP-02 Troubleshooting..... page H • 8
OP-04 RS-232C Serial Interface page H • 9
 Specifications..... page H • 9
 RS-232C Pin Connection page H • 10
 Output Circuit Diagram page H • 10
 Current Loop Pin Connection page H • 11
 HEX Code Inputs..... page H • 11
 Header 1 page H • 11
 Header 2 page H • 11
 'F 32' = "1" or "2" with Code Number page H • 11
 'F 33' = "2" Command Mode (RS-232C ONLY)..... page H • 12
 'S' UPPER and LOWER LIMITS Setting..... page H • 12
 OP-04 Notes..... page H • 13
 Controlling F-Functions..... page H • 13
Dimensions..... page **iv**

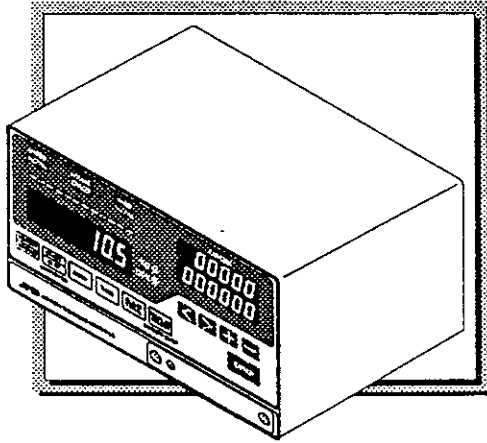

AD-4324 • Section A

Introduction



Compliance with FCC Rules

Please note that this equipment generates, uses and can radiate radio frequency energy. This equipment has been tested and has been found to comply with the limits of a Class A computing device pursuant to Subpart J of Part 15 of FCC rules. These rules are designed to provide reasonable protection against interference when equipment is operated in a commercial environment. If this unit is operated in a residential area it might cause some interference and under these circumstances the user would be required to take, at his own expense, whatever measures are necessary to eliminate the interference.

(FCC = Federal Communications Commission in the U.S.A.)



Welcome!

Thank You for Your **A&D** Purchase!

This is the INSTRUCTION MANUAL for the AD-4324 Check Weighing Indicator. The AD-4324 is the product of years of design, development, and in-field testing. It is designed to withstand harsh environmental conditions – and each indicator is subjected to several levels of quality control before it leaves the factory. Every care has been taken during the manufacturing process of this indicator to ensure that it will perform accurately and reliably for many years.

Speed, accuracy and reliability set the AD-4324 Indicator apart from every other unit in its class. The AD-4324 is a versatile and accurate check weighing tool. Four easy-to-use GO/NO-GO check comparison modes are available using the AD-4324's built-in software system. Attach to a weighing platform, check scale, or any system using load cells – then, simply select a check comparison mode and set the target weight, along with the high and low acceptable limits.

70 times-per-second high-speed sampling makes the AD-4324 ideal for dynamic weighing applications. Like its A&D predecessors, the AD-4324 is designed for flawless performance in demanding industrial applications. The analog section is completely sealed against RFI interference and A&D's Watchdog™ circuitry automatically resets the unit if a software crash develops - for uninterrupted weighing. A sealed front panel keeps out dirt, and the three displays can be easily read in any light.



Features

- High speed A/D converter - up to 70 times per second.
- LED bar shows where the weight of an object falls within the acceptance range.
- Weight, Checked and Accepted Piece count can be displayed at the touch of a button.
- Comparator function is equipped with a buzzer.
- Simple calibration via FDC (Full Digital Compensation) function with one-touch Zero Point and Span adjustment.
- WATCHDOG** circuitry virtually eliminates malfunctions commonly associated with computerized equipment.
- Screened against **RFI** (Radio Frequency Interference).
- Standard Serial Out for external printer hook-up.
- Convenient optional interfaces, parallel BCD (Binary-Coded-Decimal) and Serial RS-232C/Current Loop (Passive).

Front Panel Description

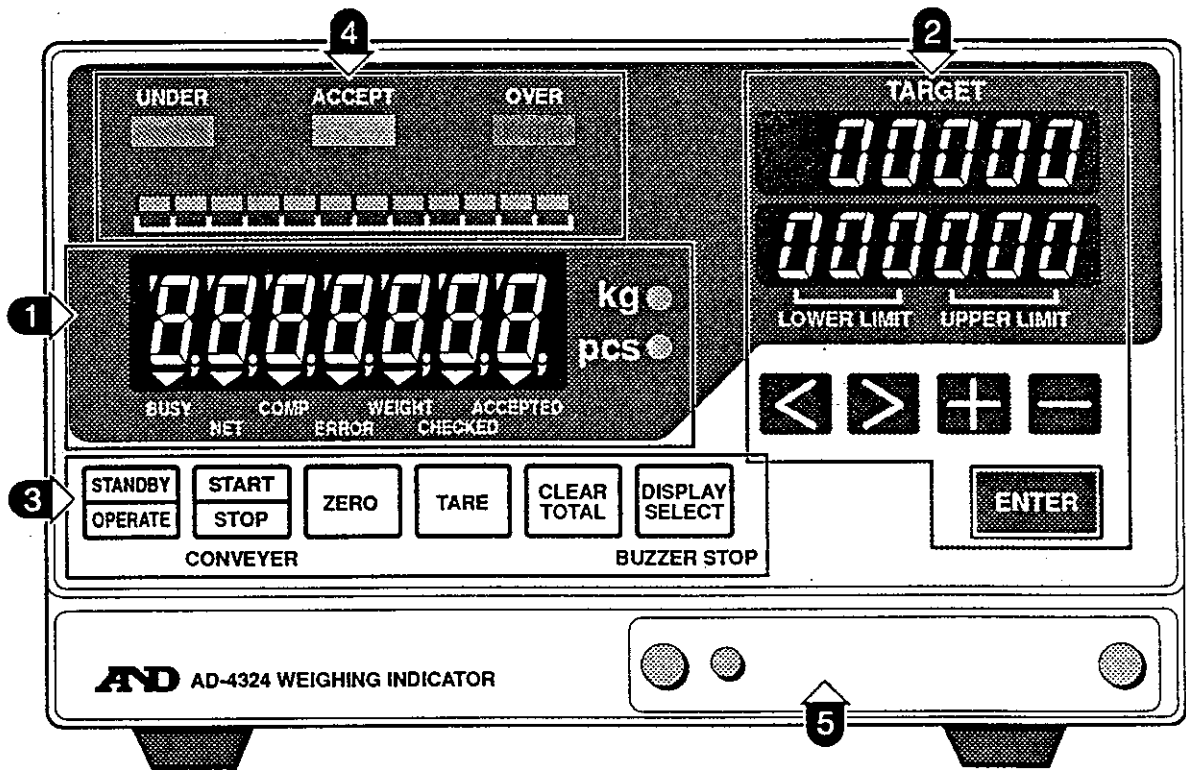

1 Main Display

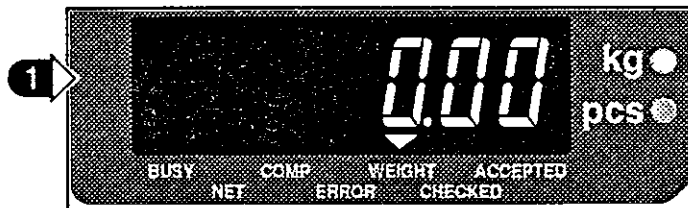

The Main Display shows weight or count results, as well as using ▼ annunciators to indicate weighing system status.

kg ● or pcs ● Annunciators

The kg annunciator will be lit when the AD-4324 is in kilogram weighing mode - the displayed weight is in kilograms. The kg ● annunciator lamp will remain ON in STANDBY mode.

The pcs annunciator will come ON when the display is showing a CHECKED or ACCEPTED peice amount.

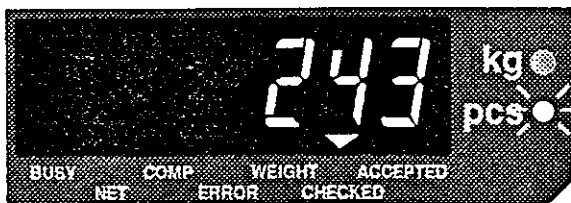

▼ System Status Annunciators

▼ **BUSY** The **BUSY** Annunciator triangle comes ON when the AD-4324 is in RUN mode (RUN output in ON).

▼ **NET** The **NET** Annunciator triangle comes ON when a TARE weight has been entered and the display is in NET mode.

▼ **COMP** The **COMP** Annunciator triangle comes ON when the comparator is in the RUN mode of **CHECK MODE-0** or **CHECK MODE-1** check weighing and a compensation factor is added to an item's weight to compensate for the force of gravity on a moving object.

▼ **ERROR** The **ERROR** Annunciator triangle comes ON when an error occurs (as an operator signal).

▼ **WEIGHT** The **WEIGHT** Annunciator triangle comes ON when a weight value is being displayed (use the **DISPLAY SELECT** key to rotate). Example below: An item weighing 150.5kg.



▼ **CHECKED** The **CHECKED** triangle comes ON when the display is the TOTAL number of peices checked (use the **DISPLAY SELECT** key to rotate). Example below left: 243 pieces checked.

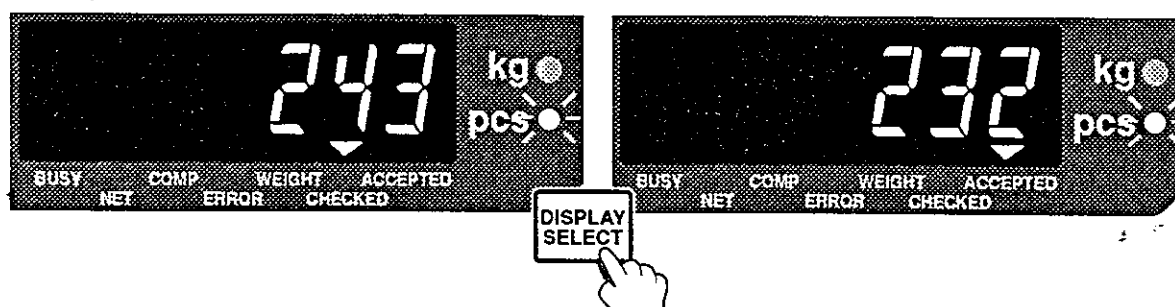

▼ **ACCEPTED** The **ACCEPTED** Annunciator triangle comes ON when the display is the number of items that were in the ACCEPT range ($\text{LOWER LIMIT} \leq \text{TARGET} \leq \text{UPPER LIMIT}$) from the amount checked as shown above (use the **DISPLAY SELECT** key to rotate). Example above right: 232 pieces accepted out of 243 checked.

2 System Operation Keys

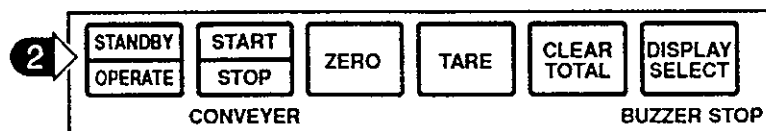

The STANDBY/OPERATE Key

The **STANDBY/OPERATE** key switches the AD-4324 between STANDBY and OPERATE mode. In STANDBY mode the displays will be OFF and all data output will stop. In OPERATE mode the displays will be ON and all Function keys will work. The power cord must be disconnected to actually stop power to the indicator. The kg ● annunciator will remain ON in STANDBY mode.



The START/STOP Key

CONVEYER

The **START/STOP** key starts and stops the RUN modes (RUN output), *with most weighing systems, this will be a conveyer.*



The ZERO Key

The **ZERO** key returns the display to the center of ZERO when the weighing device is empty (user selected within $\pm 2\%$ or 10% of the Maximum Capacity, see F-Functions F-06 and F-07), and motion is not detected. It should not be confused with the **TARE** key which re-ZERO's the display and switches to NET mode.

When an error occurs, the **ZERO** key clears the error (if error has been solved). Press & hold the **ZERO** key, then press the **STANDBY/OPERATE** key to reset.



The TARE Key

The **TARE** key switches to NET mode, ZERO's the display, stores the TARE weight in memory – as long as the weight is over zero and meets the setting of F-07. Works only in STOP mode. The NET weight (▼NET) Annunciator will come ON. Maximum TARE value is Maximum Capacity, regardless of the decimal point position (if any).

To clear the TARE weight: Press and hold the **TARE** key and press the **STANDBY/OPERATE** key – the tare will clear and the ▼NET annunciator will go OFF.



The CLEAR TOTAL Key

The **CLEAR TOTAL** key, when held down for a second-or-two, clears the TOTAL displayed (or any positive number).

**DISPLAY
SELECT**

The DISPLAY SELECT Key

The **DISPLAY SELECT** key switches the display between ▼WEIGHT, ▼CHECKED, ▼ACCEPTED displays (see page A-5).

3 TARGET, LOWER and UPPER LIMITS Section

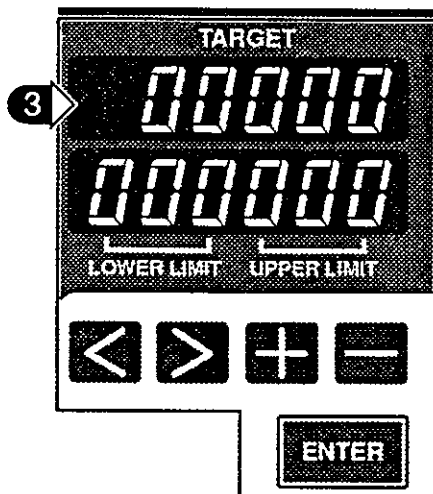

The TARGET display shows a set target weight of up to 5 digits.

The LOWER LIMIT and UPPER LIMIT displays show the LOWER (under) limit and the UPPER (over) LIMIT of acceptance – up to three digits.

The Setting Keys

ENTER

The ENTER Key

The **ENTER** key does two things: 1) It activates the setting mode and you will see the upper right digit start to flash (ready to be changed), and 2) Enters the settings displayed into memory.

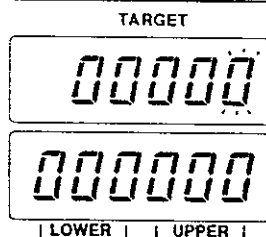

The < and > Keys

The **<** and **>** keys move the flashing cursor one place left or right for changing the settings (after pressing the **ENTER** key).

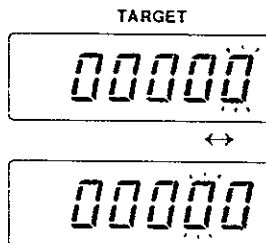

The + and - Keys

The **+** and **-** keys move the flashing digit one increment higher or lower.

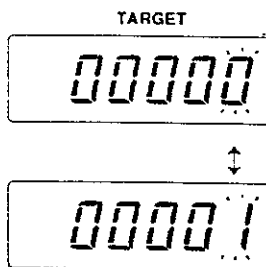

4 Acceptance Judgement Section

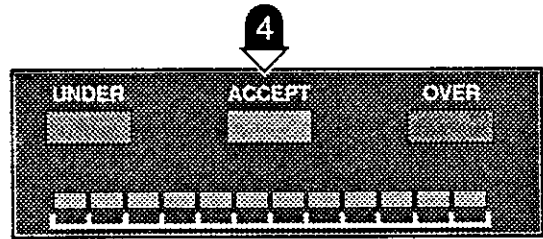

Under, Accept and Over Annunciators

ACCEPT The ACCEPT annunciator comes ON if a weight is in the acceptable range $LOWER\ LIMIT \leq TARGET \leq UPPER\ LIMIT$.

UNDER The UNDER annunciator comes ON if a weighed item is below the LOWER LIMIT. $Weight < LOWER\ LIMIT$.

OVER The OVER annunciator comes ON if a weighed item is above the UPPER LIMIT. $Weight > UPPER\ LIMIT$.

LED Acceptance Range Bar

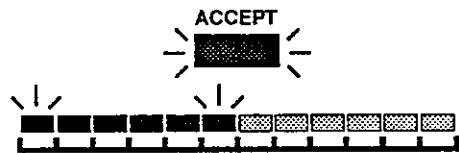

This 12 step LED bar gives a visual indication of how far-off a weighed item is from the TARGET weight. The ACCEPT annunciator comes ON and the bar lights from left to right if a weight is in the ACCEPT range, but varies from the TARGET weight. For example if a weight is half-way between the UPPER LIMIT and the LOWER LIMIT, six LED's of the twelve will come ON. If a weighed object is UNDER or OVER, the LED bar will go OFF.

5 Dip-Switches

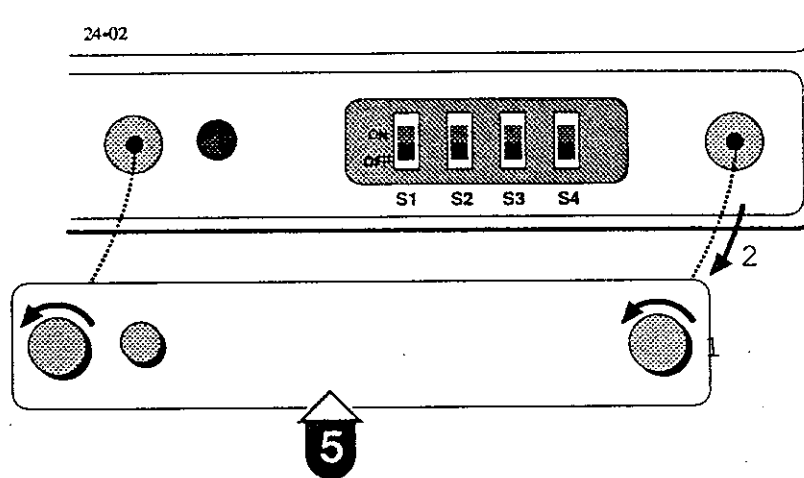

- S1** Dip Switch **S1** is for Check mode.
- S2** Dip Switch **S2** is for Calibration.
- S3** Dip Switch **S3** is for the F-Function mode.
- S4** Dip Switch **S4** is for Front Panel key enable/disabling.



Rear Panel Description

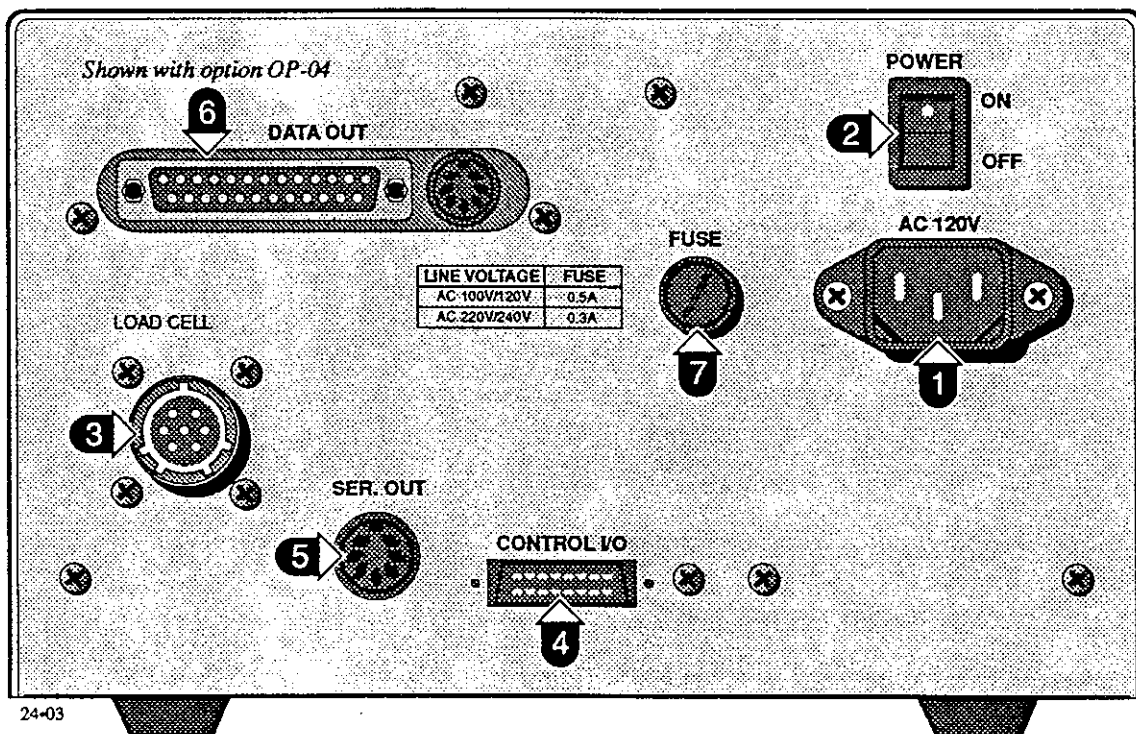

1 AC Power Input

AC Input is marked with the appropriate voltage above the three prong connector, for example: "AC 120V". Please check that the voltage is appropriate for your location, and use the grounding prong on the plug to ground the AD-4324.

2 POWER Switch

The Power Switch is simply marked "POWER." Keep the power ON when not in use and use the **STAND/OPER** key to switch OFF the display. Turn OFF the power when you are going to move the AD-4324, or if you are going to attach or disconnect any connections from the rear panel.

3 LOAD CELL

Marked "LOAD CELL," Load Cell installation is explained in CONNECTING THE LOAD CELL on page B-4.

4 CONTROL I/O

To connect with weighing equipment accepting control signals

5 SER. OUT • Serial Output

The Serial Output, marked "SER. OUT," is for the connection of a printer, score card, external display or similar device. See 'STANDARD SERIAL OUTPUT,' page G-4

6 DATA OUT • Option OP-01 or OP-04 Output

The "DATA OUT," window provided is for the BCD Output Connector Option (OP-01) or the Serial Interface Connector Option (OP-04). Only one of the two options can be attached. *The Serial Interface OP-04 is installed in the drawing on the preceding page.*

- **BCD Output Connector** - Parallel Binary-Coded-Decimal Output Connector Option (OP-01) is for sending weight data to a printer, score card, or PLC (Programable Logic Controller). See PARALLEL BCD OUTPUT, page H-2.
- **Serial Interface Connector** - Two types of serial interfaces are available with this option, the RS-232C and Current Loop interfaces (OP-04). See page H-9.

7 FUSE

The Fuse can be removed by unscrewing the Fuse Holder counter-clockwise. Use the correct fuse for the voltage used in your country.

Line Voltage	Fuse
AC 100V ~120V	0.5A
AC 220V ~240V	0.3A



Specifications

ANALOG SECTION

Input Sensitivity	0.6 μ V/D or more
ZERO Adjustment Range	0.35mV~24mV
Load Cell Excitation Voltage	12V DC \pm 5% , 280mA, with sensing. Capable of connection to up to 8 350 Ω Load Cells
Temperature Coefficient	zero ... \pm (0.2 μ V + 0.0008% of Dead Load)/ $^{\circ}$ C TYP span ... \pm 0.0008%/ $^{\circ}$ C TYP
Non-Linearity	0.01% of F.S.
Input Noise	\pm 0.3 μ v or less
Input Impedance	10 M Ω or more
Max, Measured Voltage	36mV
A/D Conversion System	Double integrating system
A/D Resolution	96000 Maximum
Max, Display Resolution	10000 Counts Maximum
A/D Conversion Rate	Approx. 70 times/sec.

DISPLAY SECTION

Weight & State Display	
Display Element	13mm character height 7 digits 7 segment fluorescent display tube
Display Color	cobalt blue
Display Function	weight, no. of pieces, state
Judgment Display	
Display Element	square LED
Display Color	red, green
Display Function	OVER/ACCEPT/UNDER
Unit Display	
Display Element	LED
Display Color	green
Display Function	unit (kg, pieces)
Setting Display	
Display Element	10mm character height 7 segment LED 11 digits
Display Color	red
Display Function	reference value, upper Limit, lower limit (upper / lower limit values)
Others	
Power Source	100, 115, 220, 240V $\begin{matrix} +10\% \\ -15\% \end{matrix}$ AC, 50/60Hz, approx. 20VA
Weight	approx. 3.4kg
Operating Temp. Range	-5 to +40°C (23°F to 104°F)
Operating Humidity Range	85% RH or less (non- condensing)
External Dimensions	218(W) X 221(D) X 135(H) mm (Refer to the outline drawing.)
Options	
OP-01	Parallel BCD output (open collector)
OP-02	Relay I/O
OP-04	Serial I/O (RS-232C, current loop)
OP-05	Indicator stand
OP-06	Panel mount metal fittings
OP-10	Printer mount metal fittings
Accessories	

Fuse	100 to 120VAC = 0.5A 220 to 240VAC = 0.3A
Load Cell Connector	1
I/O Connector	1
Serial Output Connector	1
Power Cable	1 (KO: 115, ET: 9102)
Weighting Name Plate	1
Upper/lower Limit Valve Seal	1
Unit Seal	1

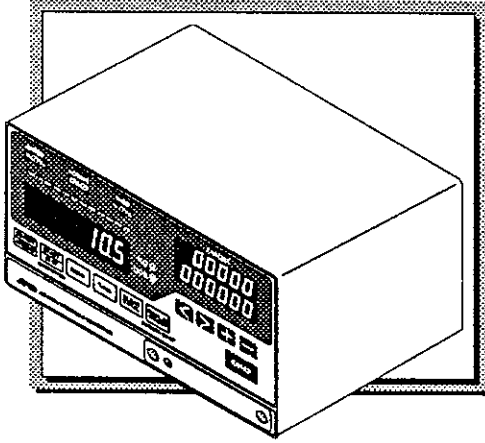

AD-4324 • Section B

Installation



Unpacking & Setting Up



Do not plug in your power cable until you have completely set up everything else!

1

When you receive your AD-4324 Weighing Indicator the following should be included in the packaging:

- | | |
|--|--|
| <input type="checkbox"/> This Manual. | <input type="checkbox"/> A Load Cell Connector. |
| <input type="checkbox"/> The Weighing Indicator. | <input type="checkbox"/> A Control I/O Connector. |
| <input type="checkbox"/> Power Cord. | <input type="checkbox"/> A Replacement Fuse (0.5A). |
| | <input type="checkbox"/> A Capacity Sticker (place on dip-switch cover panel). |

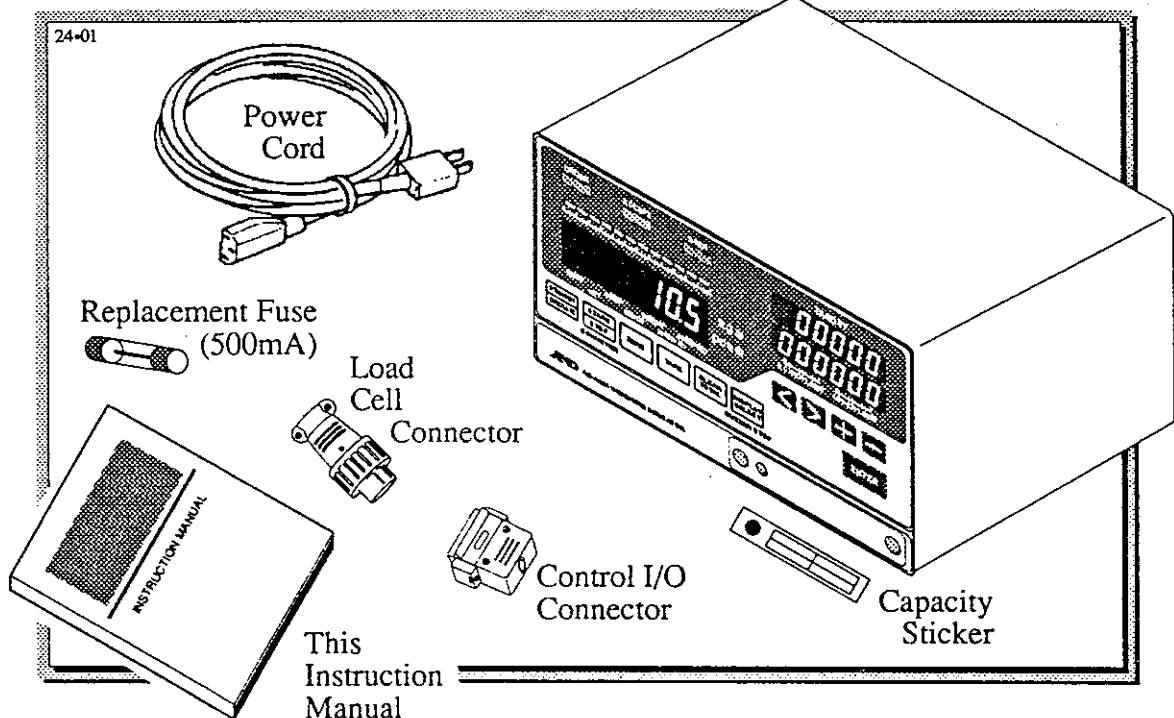

2

Connect the AD-4324 to the Weighing Device Load Cell(s) via the back panel LOAD CELL connector. See 'CONNECTING THE LOAD CELL' on page B-4. Make any other connections at this time as well; optional attachments, Control I/O's, or an A&D printer or display.

3

Mount the Capacity Sticker on the Dip-Switch cover. Remember to mark down your Weighing Indicator's Maximum Capacity and Minimum Division in the space provided after calibrating (see 'FULL CALIBRATION PROCEDURE', page C-5). Also, mark the AD-4324's section weight in the space provided.

4

Connect the AC power cord (and see that the cord is grounded).



Be sure to disconnect AC power before connecting or disconnecting any I/O on the rear panel.

Best Conditions for Use



To ensure that you get the most from your weighing indicator, please try to meet the following conditions as closely as possible:

- Don't install in direct sunshine. Avoid sudden temperature changes, vibration, wind, water, or excessive dirt.
- The operating temperature range is from about -5°C/23°F to 40°C/104°F. The best temperature is at about 20°C/68°F with 50% Relative Humidity.
- Analogue input/output signals are sensitive to electrical noise. Do not bind the cables together as it could result in cross-talk interference. Please also keep them well away from AC power cables. Keep all cable/coax as short as possible.
- If the local AC electricity supply fluctuates by more than $\pm 10\%$, an AC regulator must be used to stabilize the power supply.



Connecting the Load Cell



- To connect your load cell to the Weighing Indicator use a six-wire cable with shield - connect the wires as indicated below. If the AD-4324 is located near the Load Cells (within a few yards or meters) you may use a 4-wire cable with shield, but first connect pins 1 & 2 and 3 & 4 with independent jumper leads.
- The analogue output from the Load Cell and the RS-232C input/output signals are sensitive to electrical noise. Do not bind these cables together as it could result in cross-talk interference. Please also keep them well away from AC power cables.

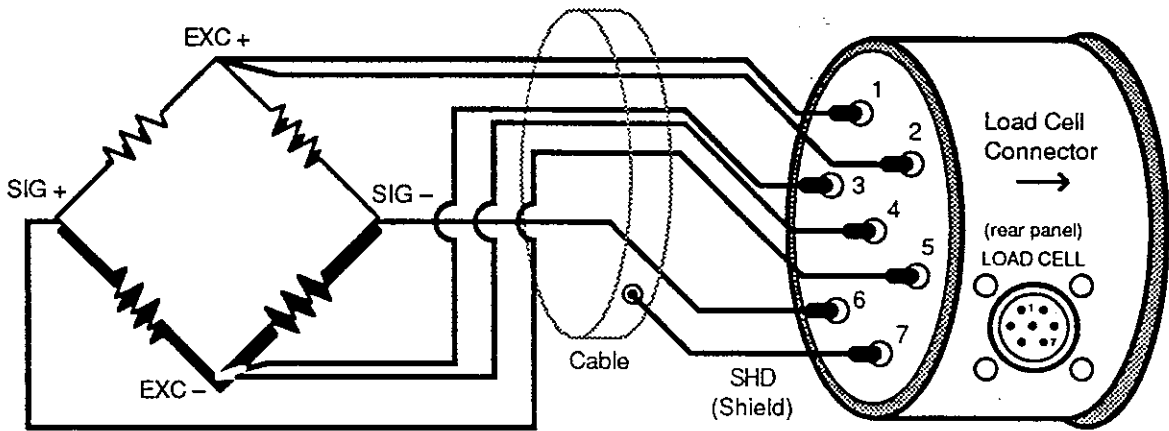

Load Cell Connections			
Screw	Signal	Screw	Signal
1	Positive Excitation Voltage (EXC+)	5	Positive Signal Voltage (SIG+)
2	Positive Sense Voltage (SEN+)	6	Negative Signal Voltage (SIG-)
3	Negative Sense Voltage (SEN-)	7	Shield (SHD)
4	Negative Excitation Voltage (EXC-)		



Load Cell and Input Sensitivity

The relationship between the Load Cell and the Input Sensitivity (X) of the AD-4324 is formulated below:

Load Cell Capacity	"A"	Example:	"A"	=	100kg
Rated Output	"B"		"B"	=	3mV/V
Max. Capacity of Platform	"C"		"C"	=	50kg
Min. Division of Display	"d"		"d"	=	0.01kg
Excitation	"EXC"		"EXC"	=	12V

- Using the above terms and numbers – the following equation can be solved: $X = a * EXC * B * 1,000 * (d / C) \mu V$
- "a", the actual Load Cell Range, is C / A . If you are using multiple load cells, the sum of all load cell ratings equals "A", and if your load cell has levers determine "a" according to the lever ratio.
- Using the above equation, Input Sensitivity (X) equals $3.6 \mu V$. System design will be satisfactory if "X" is between $0.6 \mu V$ and $36 \mu V$.



Select Check Weighing Mode



You must select the check weighing mode desired (unless your dealer has done it for you). The modes are illustrated on page D-4.



To Set Check Mode

1

- 1 Start with the backpanel POWER switch turned OFF:
- 2 Press and hold the **STANDBY/OPERATE** and **ZERO** keys;
- 3 Then turn the POWER switch back ON.

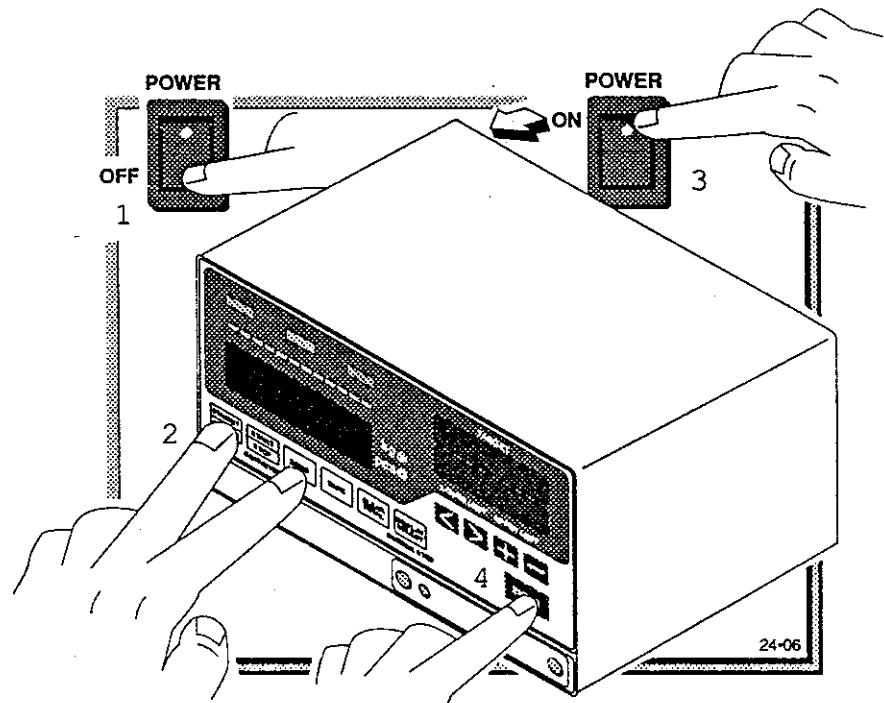

2

- "in it TYPE" will appear on the Main display.

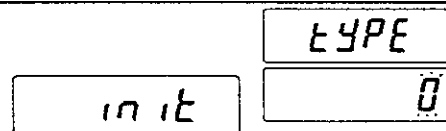

- ▣ If you want to change the Check Mode type, use the **+** and **-** keys to move through the available settings.



1→2→3→4→5



When you change a Check Mode type setting: ZERO correction, TARE weight, UPPER and LOWER limits and pieces WILL BE CLEARED.

3

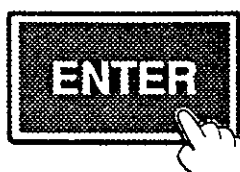

- ▣ When the new setting is displayed, press the **ENTER** key to enter the setting into memory.
- ▣ If you do not want to change the setting after all, simply turn the power OFF and ON once again.

Display Resolution Table

Maximum Capacity	RESOLUTION					
	1 Min. Div.	2 Min. Div.	5 Min. Div.	10 Min. Div.	20 Min. Div.	50 Min. Div.
300	1/300					
400	1/400					
500	1/500					
600	1/600	1/300				
800	1/800	1/400				
1,000	1/1,000	1/500				
1,200	1/1,200	1/600				
1,500	1/1,500	1/750	1/300			
2,000	1/2,000	1/1,000	1/400			
2,500	1/2,500	1/1,250	1/500			
3,000	1/3,000	1/1,500	1/600	1/300		
4,000	1/4,000	1/2,000	1/800	1/400		
5,000	1/5,000	1/2,500	1/1,000	1/500		
6,000	1/6,000	1/3,000	1/1,200	1/600	1/300	
8,000	1/8,000	1/4,000	1/1,600	1/800	1/400	
10,000	1/10,000	1/5,000	1/2,000	1/1,000	1/500	
12,000		1/6,000	1/2,400	1/1,200	1/600	
15,000		1/7,500	1/3,000	1/1,500	1/750	1/300
20,000		1/10,000	1/4,000	1/2,000	1/1,000	1/400
25,000			1/5,000	1/2,500	1/1,250	1/500
30,000			1/6,000	1/3,000	1/1,500	1/600
40,000			1/8,000	1/4,000	1/2,000	1/800
50,000			1/10,000	1/5,000	1/2,500	1/1,000
60,000				1/6,000	1/3,000	1/1,200
80,000				1/8,000	1/4,000	1/1,600
100,000				1/10,000	1/5,000	1/2,000
120,000					1/6,000	1/2,400
150,000					1/7,500	1/3,000
200,000					1/10,000	1/4,000
250,000						1/5,000
300,000						1/6,000
400,000						1/8,000
500,000						1/10,000

○ When the minimum division is set to 10, 20 or 50 - the main display will use all 6 digits.

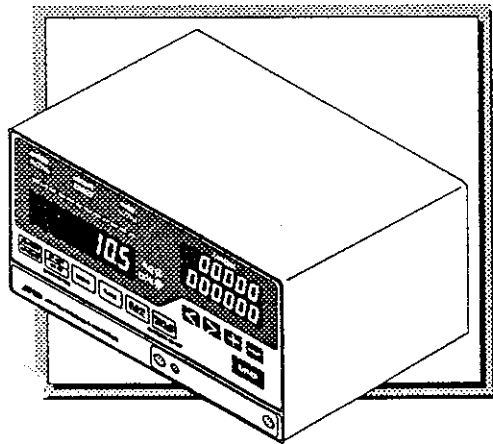

AD-4324 • Section C

Calibration



Calibration Terms

The section 'FULL CALIBRATION PROCEDURE', starting on C-5, involves the inputting of the following terms that make the AD-4324 functional as a Weighing Indicator.

Minimum Division

The Display Resolution depends on, and is limited by, the Minimum Division. Display Resolution is Minimum Division divided by the Maximum Capacity (see the 'DISPLAY RESOLUTION TABLE', B-6). The Minimum Division's are the blocks in which the display will be able to show change in weight. If you set the AD-4324 for 1 internal minimum division, then the display will be able to move by one, ex: 101, 102, 103... If you set it for 2 minimum divisions, then the smallest the display will be able to move is by two's, ex: 100, 102, 104.... and so forth. You are limited to 1, 2, 5, 10, 20, or 50 internal divisions – this is in turn limited by the Maximum Capacity of your weighing device. The internal divisions are different in the various weighing modes.

Zero Calibration

The ZERO Calibration is simply: re-calibrating the AD-4324, to the weighing device when it has no weight acting on it ("0"). This gives the Weighing Indicator a base reference point, "ZERO", to compare with when weight is added. It is possible that temperature changes, wear-and-tear on the Weighing Indicator, and other influences, may cause the "ZERO" point to drift - thus needing re-calibration. You may want to do ZERO Calibration on a regular schedule, as weighing conditions demand.

Maximum Capacity

The Maximum Capacity is the full weight that you want your weighing device to handle. This could be the rated capacity of the Load Cells, or some other limit you wish to set. Maximum Capacity also has a relationship to the Display Resolution. Resolution is Minimum Division divided by the Maximum Capacity. Please see the 'DISPLAY RESOLUTION TABLE' on B-6.

Span Calibration

SPAN Calibration is simply: re-calibrating the AD-4324, to the weighing device, at full capacity. With ZERO Calibration, you set an empty weighing device as your "ZERO" point. With SPAN Calibration, you set the end point of your weighing device's ability to weigh - its Maximum Capacity. This gives the AD-4324 two extreme points in which it knows the correct weight. Now it will accurately calculate what the weights are in between. While the most accurate SPAN Calibration is with Maximum Capacity as your SPAN weight – this may not always be possible. In those cases, use the weight closest to Maximum Capacity that is practical.



The closer to Maximum Capacity the SPAN weight is – the more highly accurate the reading will be (especially at the higher end).



If You Want to Perform...

ZERO Calibration ONLY

If you only want to perform the simple calibration procedure – use the 'ZERO CAL & FINE SPAN' procedure, C•8.

Minimum Division Change ONLY

If you only want to change the Minimum Division – use the 'FULL CALIBRATION PROCEDURE' (C•5), after Step 4, press the **ENTER** key, and slide the Calibration Dip-Switch, "S2" OFF.

Maximum Division Change ONLY

If you only want to change the Minimum Division – use the 'FULL CALIBRATION PROCEDURE' (C•5), after Step 7, press the **ENTER** key, and slide the Calibration Dip-Switch, "S2" OFF.

SPAN Calibration ONLY

If you only want to do SPAN Calibration – use the 'ZERO CAL & FINE SPAN' procedure, C•8.

Any Mix of Changes

If you only want to make some other mix of changes or calibrations, please go through the procedure from the beginning and make your choices as you move through.



Calibration Flowchart

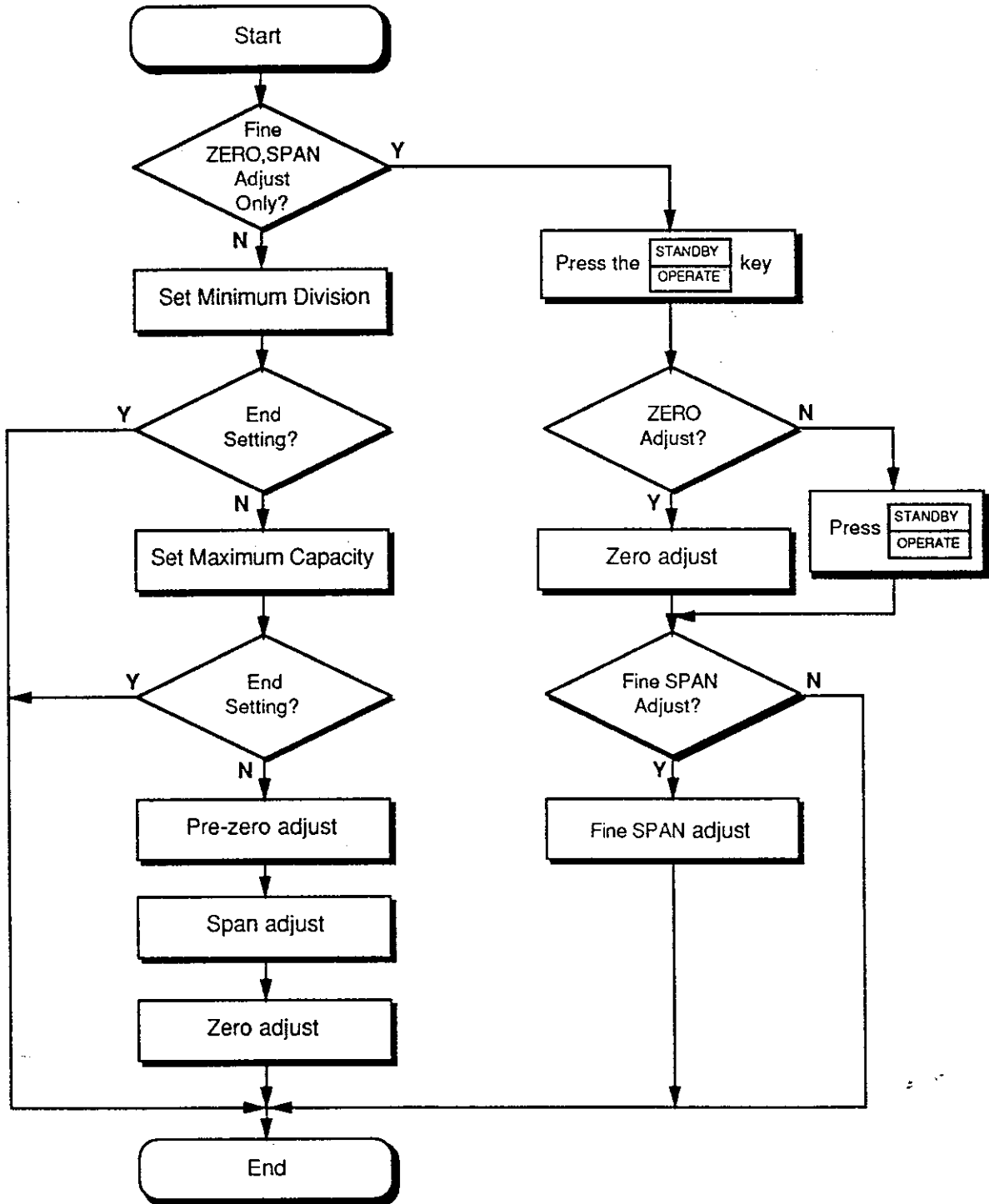

Full Calibration Procedure

Calibration, Minimum Division and Maximum Capacity Settings



Your AD-4324 should be calibrated: when first installed, if moved, after Re-installation and on a regular basis as conditions warrant. Calibration is part of regular weighing operation, correcting changes in temperature, humidity, air pressure, etc.



The AD-4324 must be warmed up (plugged in and the rear panel power switch on) for at least 30 minutes before starting calibration.

During calibration, the weighing system must be kept stable for accurate adjustment.

The display examples shown in this procedure are initial ones. After this procedure has been done once, the example numbers may be different than the actual numbers displayed on your indicator.

1



Press the **STANDBY/OPERATE** key to turn the display ON – have nothing on the weighing surface.

2

Open the Dip-Switch cover on the front panel of the AD-4324 unit by unscrewing the knobs counter-clockwise to expose the Dip-switches.

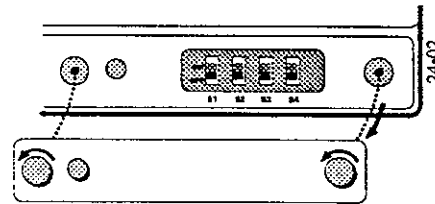

3

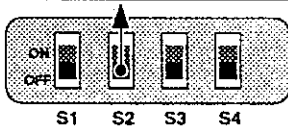

Slide the second Dip-Switch marked "S2", up to ON.

"CAL" will appear on the Main display.

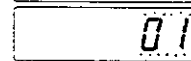
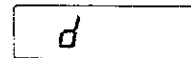
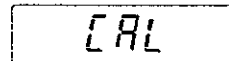

TARGET

"d" will appear on the TARGET display. This indicates that you are setting the internal Minimum Division.

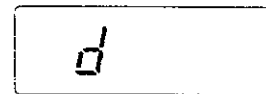

"01" will be flashing on the lower display. This is the current Minimum Division setting.

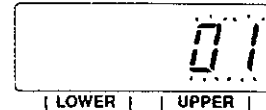

4

If you do not want to change the Minimum Division go on to Step 5.

If you want to change the Minimum Division, use the **+** and **-** keys to move through the available divisions. **Do not use** the **<** and **>** keys unless you want to go straight to 'ZERO Calibration', page C-8.



1→2→5→10→20→50
Divisions

You are limited to one of the following internal Minimum Divisions: 1, 2, 5, 10, 20, or 50 - see the 'DISPLAY RESOLUTION TABLE', p. B-6.

5

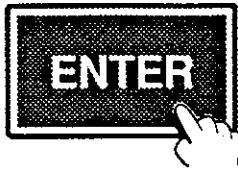

- ⚠ If there is no change to the Minimum Division, or if you have already changed to the new setting, press the **ENTER** key.
- ⚠ If you only wanted to change the Minimum Division go to Step 14 and finish.

- ▶ After you press the **ENTER** key – "CAP" will appear on the TARGET display.
- The lower display shows the Maximum Capacity weight presently entered. The last digit will be flashing.

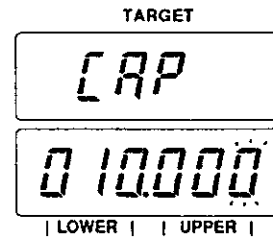

6

- ⚠ If you do not want to change the Maximum Capacity, go to Step 7.
- ▶ If you wish to change the Maximum Capacity, you may do so now by using the keys as described in the 'CALIBRATION KEY ENTERING' table. Enter in the Maximum Capacity of your weighing device.

	<h3>Calibration Key Entering</h3>		<p>The ENTER key stores settings into memory and moves to the next screen.</p>
<p>○ The < key moves the flashing cursor digit to the left.</p>	<p>○ The + key increases the flashing cursor by one digit.</p>		
<p>○ The > key moves the flashing cursor digit to the right.</p>	<p>○ The - key decreases the flashing cursor by one digit.</p>		

7

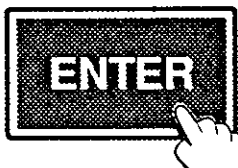

- ▶ If there is no change to the Maximum Capacity, or if you have already changed to the new setting, press the **ENTER** key.
- ▶ If you have now finished changing what you wanted - go to Step 14 and finish.

- ▶ After you press the **ENTER** key – "PCAL 0" will appear on the TARGET display.
- The lower display blanks.

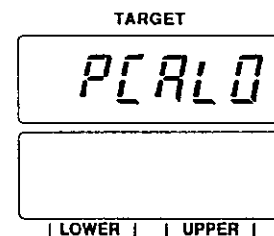

8

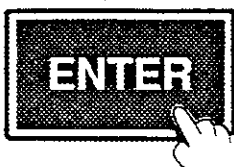

▶ Press the **ENTER** key again and a series of periods appear across the lower display for a few seconds, followed by:

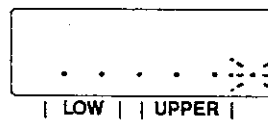

- "SPAn" (SPAN Calibration) will appear on the TARGET display
- The lower display shows the Maximum Capacity weight entered in Step 6. The last digit will be flashing.

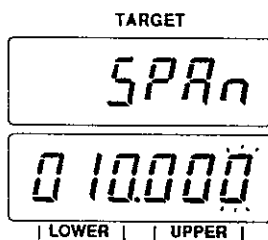

9

▶ If you are not using the Maximum Capacity as your SPAN weight, or if the exact weight of the Calibration Mass is known – please enter in the weight of the calibration mass by using the keys described in the 'CALIBRATION KEY ENTERING' table on C-6.

10

▶ Place your calibration mass on the weighing device.

1



▶ Press the **ENTER** key again after you have entered the SPAN weight or loaded the calibration mass. A series of periods will blink across the lower display for a few seconds, followed by:

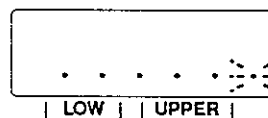

- "CAL 0" will appear on the TARGET display.
- The lower display blanks.

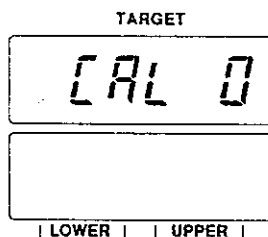

12

▶ Remove the calibration mass from the weighing device.

13

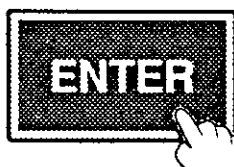

▶ Press the **ENTER** key again and a series of periods appear across the lower display for a few seconds, followed by:

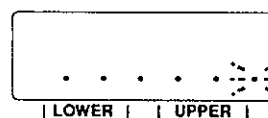

- "End" will appear on the TARGET display indicating the end of full calibration.

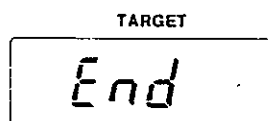

14

- ▶ Slide the second Dip-Switch, "S2", back to the OFF position.
- ▶ Replace the Dip-Switch cover.

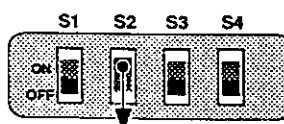

✚ ZERO Cal & Fine SPAN

Periodic Calibration Adjustment of ZERO Point and Manual SPAN – to Maintain Accuracy



The display examples shown in this procedure are initial ones. After this procedure has been done once, the example numbers may be different than the actual numbers displayed on your indicator.

1

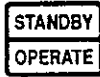

▶ Press the **STANDBY/OPERERATE** key to turn the display ON – have nothing on the weighing surface.

2

▶ Open the Dip-Switch cover on the front panel of the AD-4324 unit by unscrewing the knobs counter-clockwise to expose the Dip-switches.

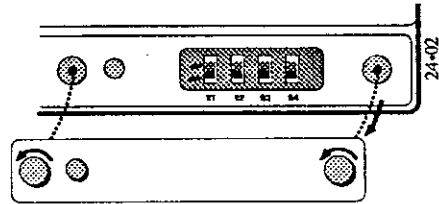

3

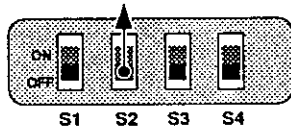

▶ Slide the second Dip-Switch marked "S2", up to ON.

○ "CAL" will appear on the Main display.

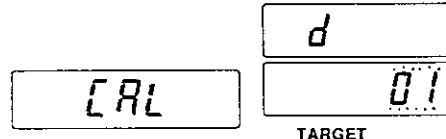

○ "d" will appear on the TARGET display. This indicates that you are setting the internal Minimum Division.

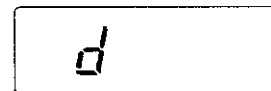

○ "01" will be flashing on the lower display. This is the current Minimum Division setting.

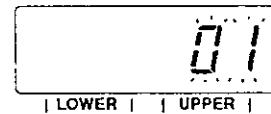

4

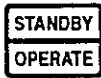

▶ Press the **STANDBY/OPERERATE** key to bypass the Min. Division, Max. Capacity and Span Calibration:

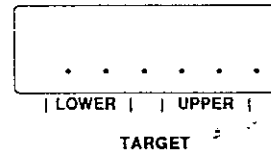

○ "CAL 0" will appear on the TARGET display.

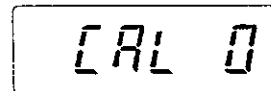

○ The lower display blanks.

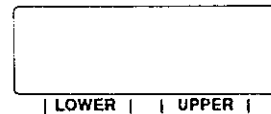

5



▶ If you only want to do manual SPAN adjustment, then press the **STANDBY/OPERERATE** key to bypass ZERO Calibration.



▶ Press the **ENTER** key if you do want to perform ZERO Calibration. A series of periods will blink across the lower display, followed by:

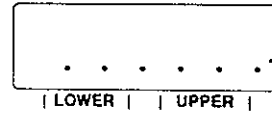

- "SPAnR" (SPAN Calibration Adjustment) will appear on the TARGET display
- The lower display shows the Maximum Capacity weight entered in Step 6. The last digit will be flashing.

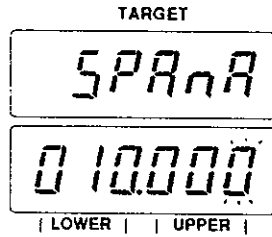

6

- ▶ Load the standard weight you are using on the weighing device. The display will show it's weight.
- ▶ To perform Fine SPAN Adjustment on the standard weight please use the keys described in the 'CALIBRATION KEY ENTERING' table, page C-6, to adjust the standard weight.

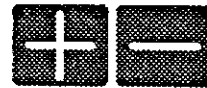

7

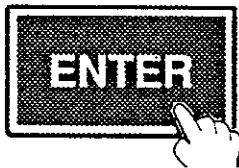

▶ Press the **ENTER** key again and a series of periods appear across the lower display for a few seconds, followed by:

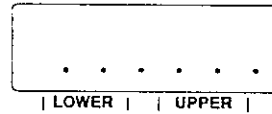

- "End" will appear on the TARGET display indicating the end of full calibration.

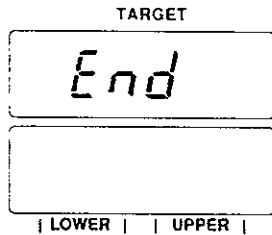

8

- ▶ Slide the second Dip-Switch, "S2", back to the OFF position.

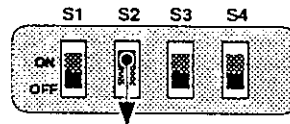

9

- ▶ Return the Dip-Switch cover to the front panel by screwing the knobs clockwise.



Calibration Errors

All Calibration Errors will appear on the Lower/Upper Limit display.

❑ Errors:

Error

'Error 1' will be displayed if the resolution exceeds 1: 10,000.

1

- ▶ Check the Minimum Division and Maximum Capacity ratio. Make sure that the resolution does not exceed 10,000 Divisions.

Error

'Error 2' will be displayed if the Load Cell output is too large at ZERO Calibration.

2

- ▶ In this case add an additional resistor between EXC+ and SIG-.

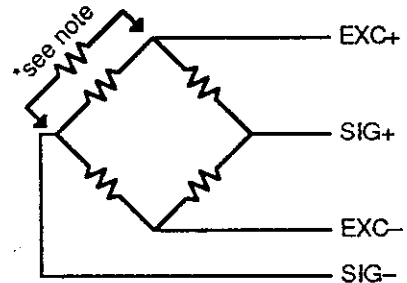

Error

'Error 3' will be displayed if the Load Cell output is too small (negative offset) at ZERO Calibration.

3

- ▶ In this case add an additional resistor between EXC+ and SIG+.

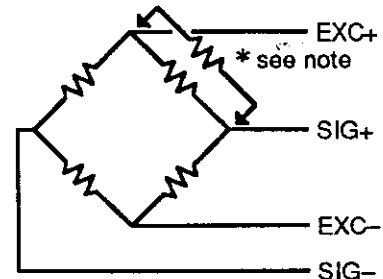

NOTE: *The resistor should have as high a resistance as possible (50kΩ to 500kΩ) and should be of the highest quality, having the lowest temperature coefficient.*

'Error 4' will be displayed if the Calibration Mass has been mistakenly entered as a value greater than the Maximum Capacity.

- ▶ Re-enter the 'Cal SPAN' weight in step 8 of the 'FULL CALIBRATION PROCEDURE', C-5.

'Error 5' will be displayed if the Calibration Mass has mistakenly been entered as "0", or if it is smaller than the Minimum Division.

- ▶ Re-enter the 'Cal SPAN' weight in step 8 of the 'FULL CALIBRATION PROCEDURE', C-5.

'Error 6' will be displayed if the Load Cell output is too low.

- ▶ Replace your Load Cell with a more sensitive one, or adjust the Minimum Division and Maximum Capacity ratio from the 'DISPLAY RESOLUTION TABLE' on page B-6. Make the resolution smaller.

'Error 7' will be displayed if the Load Cell signal pins are reversed, incorrectly wired, or the Load Cell output voltage at capacity weight is too low.

- ▶ Check the load cell – if it is all right then you will need to add an additional resistor between EXC+ and SIG+. See 'Error 3' diagram.

'Error 8' will be displayed if the Load Cell output voltage at capacity weight is too high.

- ▶ Check the load cell – if it is all right then you will need to add an additional resistor between EXC+ and SIG-. See 'Error 2' diagram.



'Error 11' will be displayed if the ZERO or TARE were not cleared during Fine SPAN Adjustment.



- ▶ Clear ZERO and/or TARE and re-start Calibration.

Timer Setting Procedure

Mode 0 is the most difficult and so we will describe it here.

Mode 0

- F6.....HI/GO/LO Output Pause Timer
- F7.....HI/GO/LO Output Length Timer
- F10.....Judgement Sampling Rate
- F14.....Placement timer

Time periods set by the above functions are called T6, T7, T10 and T14 respectively.

(For example, $T6 = F6 \times 0.014 \text{ sec.}$ $F6 = 70 \dots$ about 1 sec.)

Where:

Conveyor speed.....VC [m/sec.]

Conveyor length.....LC [m]

Then, the time period required for a weighed article from being placed on the conveyor (with the location detection signal changing From OFF to ON) till being removed must be $TC = LC/VC$ [sec.], where T10 = T14 is shorter than this.

F14 starts with delay of about 0.2 sec. when the location detection signal is turned on. With the length of a weighed article as LS[m], T14 needs LS/VC [sec.] or more.

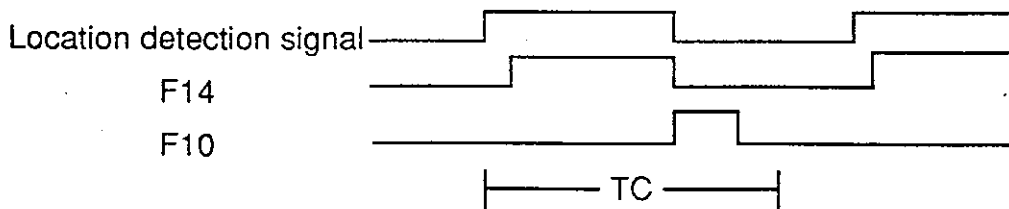
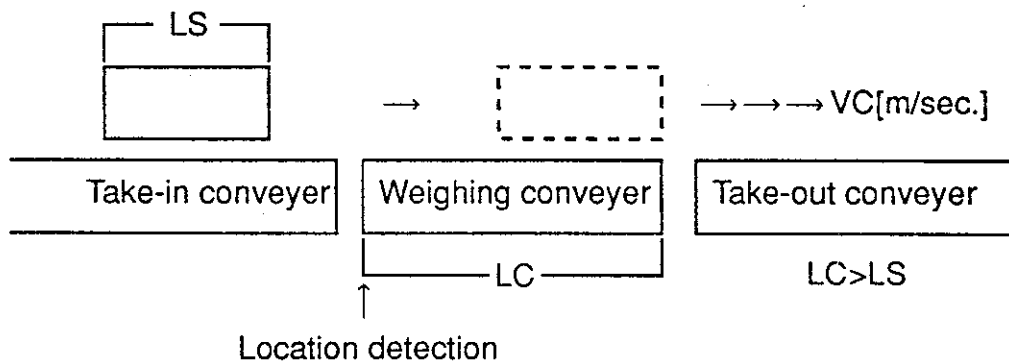

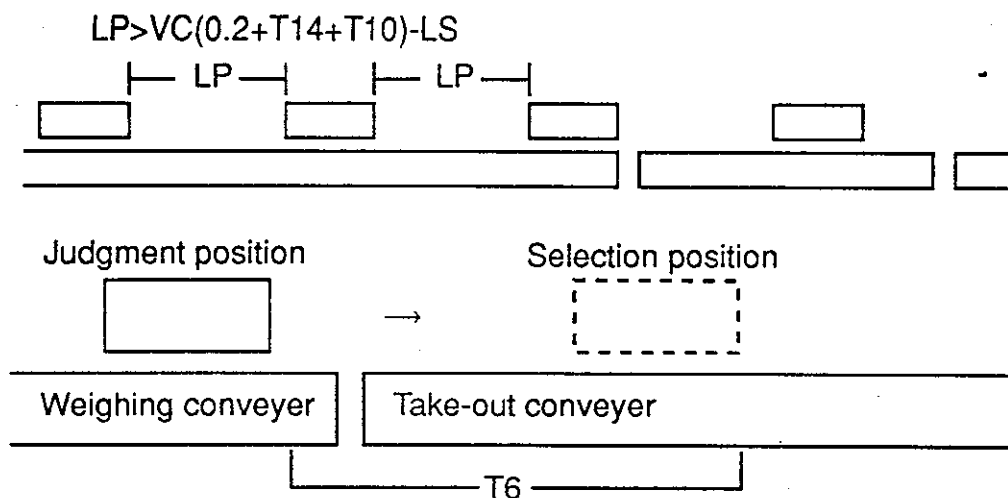

F6 sets time during which a weighed article moves from completion of judgment to the selection position, while F7 sets a time period during which judgment output is on.



Compensation of Weight

A weight, which is weighed in transfer on a conveyor, may be less (or more) in a fixed ratio compared with its actual weight.

In Mode 0 or 1, since judgment is made based on the weight weighed in motion, the weighed value is corrected with its value multiplied by F13 value so that the final value becomes equal to that weighed in the stop state.



F13 Setting

1

- ▣ Preset the judgement sampling rate (F10) and digital filter (F12). F13 is set to 1.0000 beforehand.

2

- ▣ Set to stop mode. Confirm that weight display is 0 without any article placed on the weighing conveyor. (If not 0, press "Zero" key.)

3

- ▣ Place an article which is actually to be weighed on the conveyor and weigh the article. The article weight at this time is taken as "Stop weight". Remove the article.

4

- ▣ Press "Run/Stop" key to put in the Run mode.

- 5** ▶ Feed an article weighed in stop mode onto the conveyor and take the judgment result.
- 6** ▶ By feeding the same article several times, obtain the mean value. This mean value is taken as "weight in motion".

$$F13 = \frac{\text{"Stop weight"}}{\text{"Weight in motion"}}$$

- 7** ▶ Set the value obtained in the above expression into F13 in Function mode. With F13 other than 1.0000, "Run" is lit in Run mode.
- 8** ▶ Weigh an article in Run mode and confirm that the result is equal to the "Stop weight".

Example:

With "Stop weight" is 12.345kg and "Weight in motion" of 12.340kg, F13 = 1.0004.

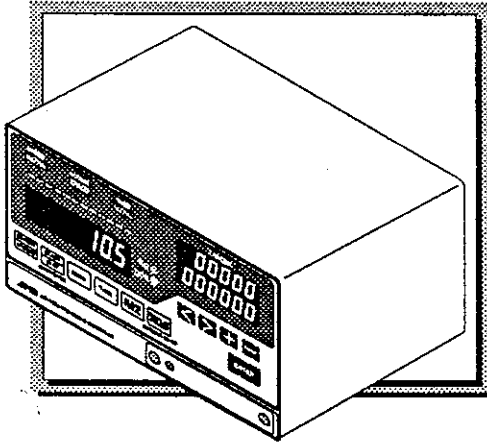

AD-4324 • Section D

Check Modes



Check Weighing Operation



The AD-4324 has two main modes of operation: 1 The **STOP MODE** in which the indicator act like a normal weighing indicator (it is not operating any automatic machinery), and; 2 The **RUN MODE** in which the AD-4324 is capable of driving other machinery in accept/reject operations.



The STOP MODE

- A The main display shows an object's weight.
- B The front panel key are able to operate.
- C ACCEPT, OVER, and UNDER LED's operate only when in Check Modes 4 or 5.
- D You can set the TARGET, LOWER and UPPER Limits.



The RUN MODE

- A The operator starts the RUN MODE by pressing the **START/STOP** key (except in Check Mode 4).
- B The control outputs become active and the ACCEPT, OVER, and UNDER LED's come ON at the end of a JUDGEMENT operation.
- C Only the **START/STOP** , **DISPLAY SELECT** and **CLEAR TOTAL** keys will operate while in the RUN MODE.
- D For the RUN MODE to operate correctly, the AD-4324's has built-in timers, these timers are set by the following F-Fuctions:

<p>F - 6 Hi/Go/Lo Output Pause Timer see page F-9</p>	<p>This F-Function controls the amount of time: from the completion of JUDGEMENT, to the output of the comparator HI, GO or LO results. [Check Modes 0 & 2 only].</p>
<p>F - 7 Hi/Go/Lo Output Length Timer see page F-9</p>	<p>This F-Function controls the lenght of time for the comparator HI, GO or LO output.</p>
<p>F - 10 JUDGEMENTSampling Rate see page F-12</p>	<p>This F-Function controls the amount of time that object is sampled for JUDGEMENT.</p>
<p>F - 14 Placement Timer see page F-14</p>	<p>This F-Function controls the amount of time: after the location detection signal (A1) has been activated until the item is correctly situated for JUDGEMENT.</p>
<p>F - 15 Mode 4 Conveyor Run Timer see page F-15</p>	<p>This F-Function controls the amount of time in Mode 4 that the weighing platform conveyor runs after the location detection signal (A1) has been received. If the result is NO GO, then the display is held.</p>

Check Mode 0

This mode is used for on-line dynamic check weighing. The product moves from the feeding conveyor onto the weighing conveyor and is weighed while in motion. The product continues onto the exit conveyor where it can be directed by the accept/reject controller.

- 1** The product is detected by a photoelectric cell as it passes onto the weighing conveyor and starts the Placement Timer (F-14).
- 2** At the end the **Placement Timer** (F-14) time, the **JUDGEMENT Sampling Rate** (F-10) starts and the product is sampled during the **JUDGEMENT Sampling Rate** period.
- 3** At the end the **JUDGEMENT Sampling Rate** period: **A** The **Hi/Go/Lo Output Pause Timer** (F-6) starts, & **B** The display shows the product's weight and the corresponding Accept, Under or Over LED's come ON.

Check Mode 1

This mode checks product in transfer in the same way as check mode 0, but stops the conveyor upon detection of a defective (low weight or high weight) and is used without the accept/reject mechanism.

Check Mode 2

This mode checks products by stopping the conveyor for examination with higher accuracy. Otherwise it is the same as check mode 0.

Check Mode 3

This mode stops the conveyor as check mode 2, and keeps it stopped upon detection of a non-defective.

Check Mode 4

This mode is for packing or filling on a conveyor which is stopped and starts the conveyor only for a non-defective.

Check Mode 5

This mode is used as a platform scale and checks the weight when a product is placed on the weighing conveyor.

Checking Modes Overview

0 CHECK MODE-0 • Fully-Automated System

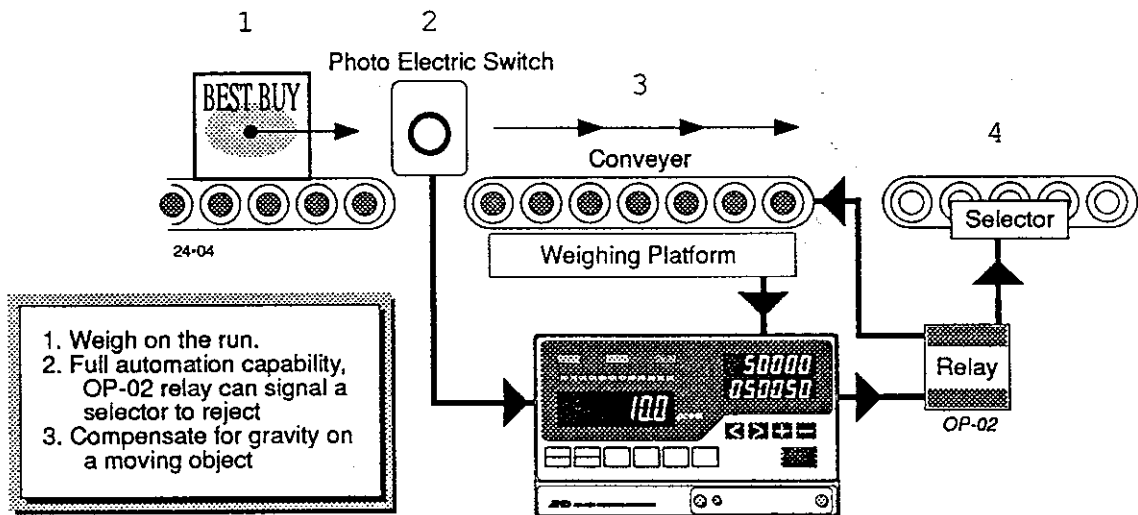

Set the acceptable weight range and a reject mechanism can discard unacceptable items automatically. Compensation is available to counter the effect of gravity on a moving object.

1 CHECK MODE-1 • Semi-Automated System

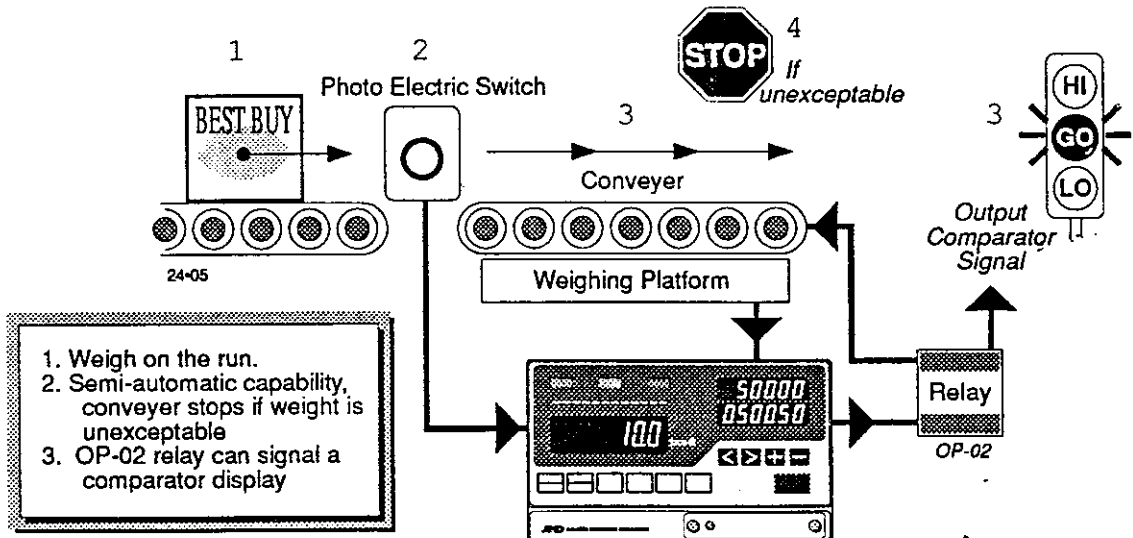

Set the acceptable weight range and if an item is not within the acceptable weight range, the conveyor stops and the buzzer sounds. Compensation is available to counter the effect of gravity on a moving object.

2 CHECK MODE-2 • Fully Automated System

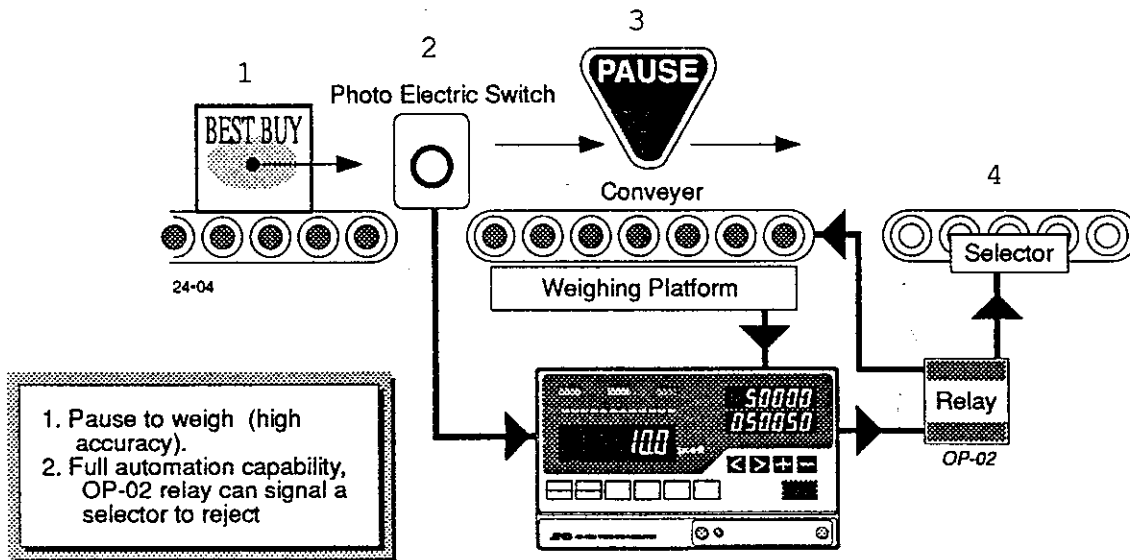

Same as **CHECK MODE-0**: Set the acceptable weight range and a reject mechanism can discard unacceptable items automatically — *Except*: Conveyor stops during weighing for higher accuracy.

3 CHECK MODE-3 • Semi-Automated System

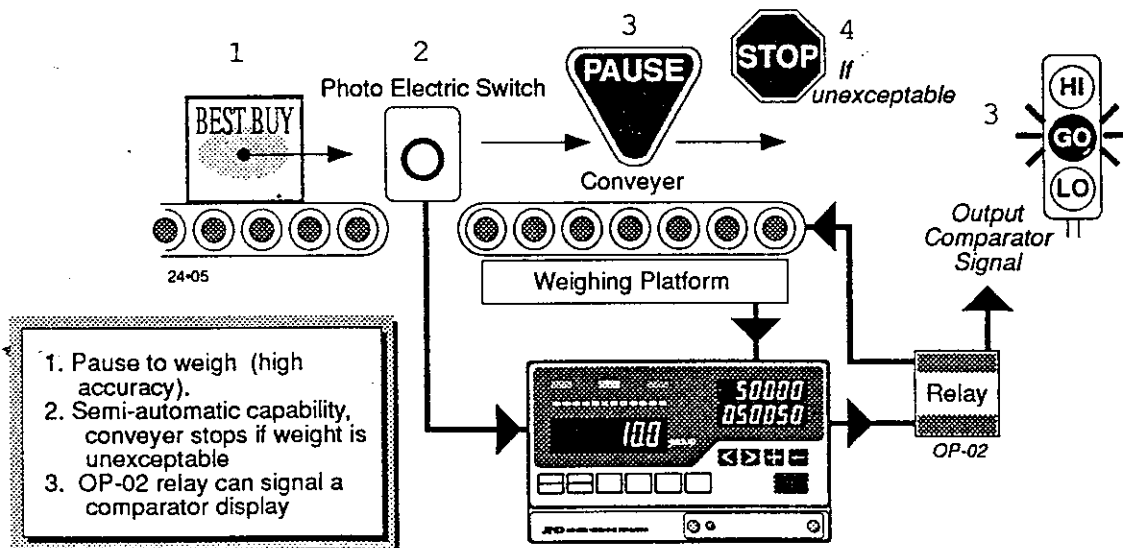

Same as **CHECK MODE-1**: Set the acceptable weight range and if an item is not within the acceptable weight range, the conveyor stops and the buzzer sounds — *Except*: Conveyor stops during weighing for higher accuracy.



Error Description

"Error" annunciator is lit (external output B5 turned on) in Stop and Run modes in the following cases.

❑ Push Zero Error

This error message is displayed when conditions set by F06 and F07 are not met upon zero correction through use of **ZERO** key or the external input A3. It is cancelled when either the conditions are satisfied or zero resetting is carried out.

❑ Weighing Over

This error message is displayed when there is load cell input which exceeds the max. capacity + 9D. (D = min. division.)

❑ Duplication Error

This error message is displayed when a location detection signal is turned on upon completion of judgment. It is cancelled either when **START/STOP** key is pressed or upon completion of the next judgment.

❑ Timer Error

This error message is displayed when two pieces of output standby timer F6, operable inside singly cannot be set because both of the two are already occupied when a judgment has completed. It is cancelled when either the output standby timer has been set upon completion of the next judgment or the **START/STOP** key has been pressed.

❑ Battery Error

When **Lo bAtt** is displayed upon supply of power, deterioration of a battery for memory or for backup is suspected.

There are two ways in how to revert from the battery error.

(1) Press the **ETNTER** key.

Recall the set-up value of Code number 0 and clear frequency data. Then, return to the weight display mode.

(2) Press the **ENTER** key while holding the **CLEAR TOTAL** key pressed.

Clear data of set-up values of Code numbers. 0 to 99, Tare Weight Value and number of Times. Then, return to the weight display mode.

Check Mode

If battery error message is displayed, check all set-up values and then restart the program.

As for errors in relation to Calibration and Function, refer to the items concerned.

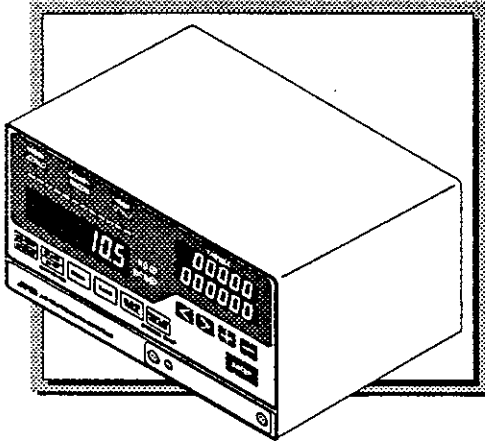

AD-4324 • Section E

Code Setting

About Code Setting Displays



100 different settings can be stored under the Code settings '00 to 99' in the 7-digit display.

The TARGET display shows a set target weight of up to 5 digits.

The LOWER LIMIT and UPPER LIMIT displays show the LOWER (UNDER) limit and the UPPER (OVER) limit of acceptance - up to three digits.

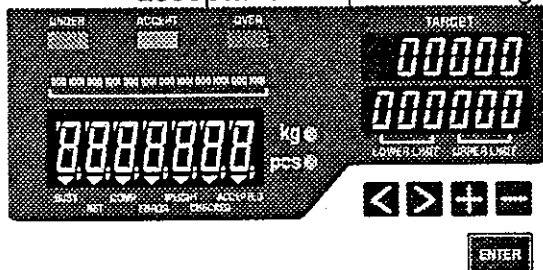

Code Setting Procedure

When 'F18' = '1'

The displays shown in this procedure are example only. The example numbers will be different from the actual numbers displayed.

1

- ▶ Press the **DISPLAY / SELECT** key to display the code number.

2

**DISPLAY
SELECT**

- ▶ Press the **DISPLAY / SELECT** key when

[Code 00] has been displayed.







- One of the two-digit display will be flashing- "00"

3

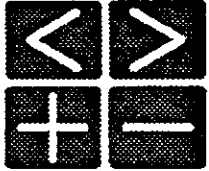
- ▶ Use the **<**, **>**, **+** and **-** keys to select the code number which has been registered or register the new code number.

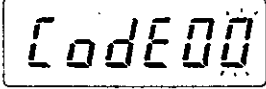
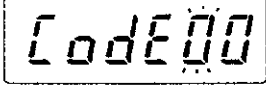
The value assigned for each code number which has been stored in memory will be displayed sequentially.

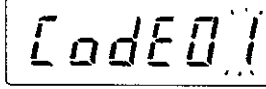
Next, if you press the **ENTER** key, the data will be verified and weight value will be changed. If the tare value has been stored in memory, it may be recalled.

	<h3>Code Number Key Entering</h3>	 <p>The ENTER key stores settings into memory and moves to the next screen.</p>
 <p>○ The < key moves the flashing cursor digit to the left.</p>  <p style="text-align: center;">↔</p> 	 <p>○ The + key increases the flashing cursor by one digit.</p>  <p style="text-align: center;">↓</p> 	
 <p>○ The > key moves the flashing cursor digit to the right.</p>	 <p>○ The - key decreases the flashing cursor by one digit.</p>	

If the wrong data has been registered, code number will return to the original code number.

To change the setting value, enter the new value and press the **ENTER** key .

If you want to stop code setting procedure , press the **DISPLAY / SELECT** key.

To Set the Tare Value for Each Code Number

1 Set the code number you desire.

2 Press the **TARE** key and the tare value will be stored into memory under the code number you set in Step 1.

To clear the tare value: after recalling the code number you desire, press and hold the **TARE** key and press the **STANBY/OPERATE** key- the tare will be cleared.

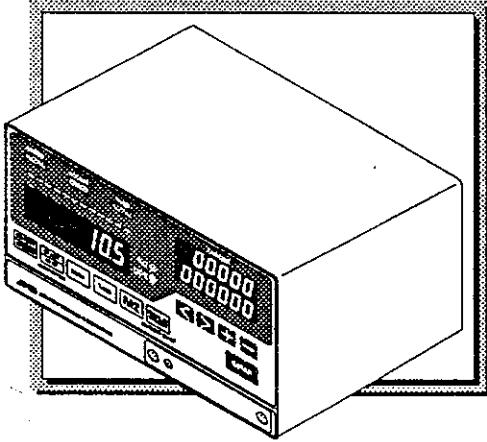

AD-4324 • Section F

F-Functions



Internal Parameter F-Functions



Your AD-4324 Indicator has a number of internal software parameters that enable you to select the best weighing features for your needs. These settings control how you want the Indicator to respond to its environment, various commands, operations and options.

All of the F-Functions have initial settings from the factory, or possibly from your dealer. You may change these settings easily as you need them, or conditions vary. Please take a moment to look through the different F-Functions on the following pages. You are able to change any F-Function listed.

F-Functions can be set using the method as explained in the section CHANGING THE F-FUNCTIONS, page F•3. The individual settings for each group are detailed in the following section THE F-PARAMETERS, page F•5.

▶ To Change an F-Function

- ▶ Follow the Steps on page F•3.

▶ Overall F-Function List

- ▶ The F-Functions are listed on page F•5 with the check mode types they will operate with.

▶ F-Functions and their Settings

- ▶ The F-Functions and their settings are detailed on page F•7. Factory settings are also indicated with a 'G' mark.

Changing the F-Functions

1 Open the Dip-Switch cover on the front panel of the AD-4324 unit by unscrewing the knobs counter-clockwise to expose the Dip-switches.

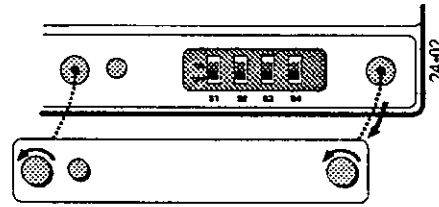

2 Slide the third Dip-Switch marked "S3", up to ON.

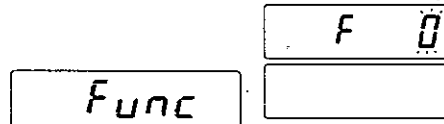
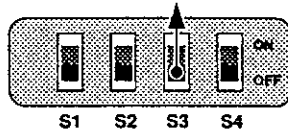

A single "0" will appear on the TARGET display. This indicates that you are in setting the F-Functions 1 thru 7.

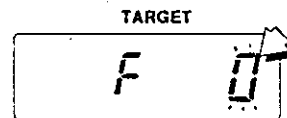

To get the "00" needed to change settings 01 thru 33, press the **DISPLAY SELECT** key now.

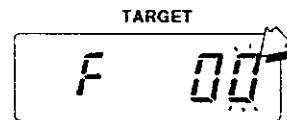
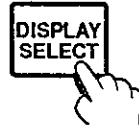

3 Use the **+** and **-** keys to move through the available F-Functions.

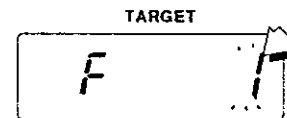

Also use the **<** and **>** keys to move through the available F-Functions 10 →33.

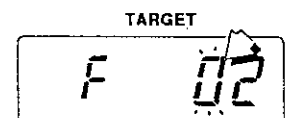

4 Press the **ENTER** key when the desired number is displayed.

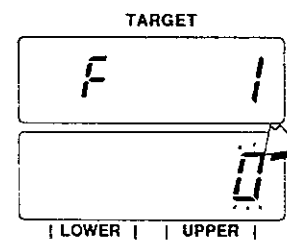
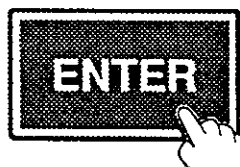
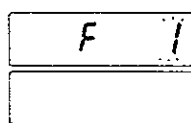

F-Function Setting

The present setting in memory is displayed.

5 Use the **+** and **-** keys to move through the available settings.

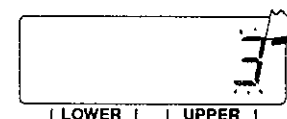
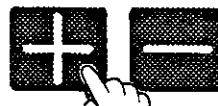

Also use the **<** and **>** keys when the settings have more than one digit.

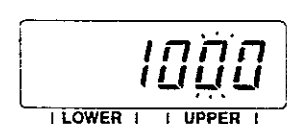

6

- ▶ Press the **ENTER** key when the desired setting is displayed.

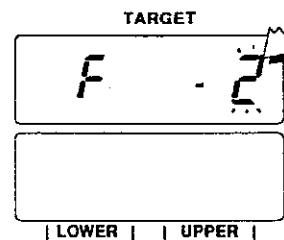
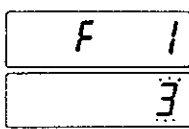

- The next F-Function is displayed.

7

- ▶ Continue moving through and changing F-Functions as desired.

8

- ▶ When finished, slide the third Dip-Switch marked "S3", down to OFF and replace the cover.

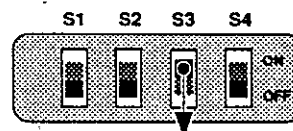

F-Function NOTES

- 1 Make sure that you press the **ENTER** key when you have changed the setting and want to enter it into memory (as in Step 6.), otherwise it will not be entered (especially the last F-Function you change before Step 8).
- 2 If you have changed a setting and do not want to enter it into memory, DO NOT press the **ENTER** key (as in Step 6.), — instead slide Dip-Switch "S3", down to OFF (as in Step 8.) or turn the back panel main POWER switch OFF and ON. Any changes made since the last time the the **ENTER** key was used to enter will not be saved.
- 3 The **STANDBY/OPERATE** key will not operate while in F-Function mode (Dip-Switch "S3", is ON).



F-Functions List

F-##	Function	CHECK MODE TYPE					
		0	1	2	3	4	5
F-1	Buzzer (Accept/Reject)	●	●	●	●	●	●
F-2	Buzzer Sound Time Length	●	●	●	●	●	●
F-3	Front Panel Key Lock-out	●	●	●	●	●	●
F-4	<input type="button" value="ENTER"/> key Lock-out	●	●	●	●	●	●
F-5	TARGET / LIMIT's Setting Input	●	●	●	●	●	●
F-6	HI/GO/LO Output Pause Time	●		●			
F-7	HI/GO/LO Output Length Time	●	●	●	●	●	

F-01	Decimal Point Position	●	●	●	●	●	●
F-02	Motion Detection Time	●	●	●	●	●	●
F-03	Motion Detection Width (Count)	●	●	●	●	●	●
F-04	ZERO Tracking Time	●	●	●	●	●	●
F-05	ZERO Tracking Width	●	●	●	●	●	●
F-06	Set ZERO Range	●	●	●	●	●	●
F-07	<input type="button" value="ZERO"/> & <input type="button" value="TARE"/> keys Availability	●	●	●	●	●	●
F-08	ZERO Band (Output B7)	●	●	●	●	●	●
F-09	ZERO Band Judgement	●	●	●	●	●	
F-10	Judgement Sampling Rate	●	●	●	●	●	●
F-11	Digital Filter	●	●	●	●	●	●
F-12	Mode 0/1 RUN Digital Filter	●	●				
F-13	Mode 0/1 RUN Gravity Comp.	●	●				
F-14	Modes 0→3 Placement Timer	●	●	●	●		
F-15	Mode 4 Conveyor Run Timer					●	
F-16	Mode 0/2 Error Stop	●		●			
F-17	Modes 0/1 A1 Start Off or ON	●	●				
F-18	Code	●	●	●	●	●	●
F-19	Weighing Unit	●	●	●	●	●	●

▶ For Standard Serial Out

F-20	Baud Rate	●	●	●	●	●	●
F-21	Data Format	●	●	●	●	●	●

▶ Timer Judgement

F-22	Data Output Timer	●	●				
------	-------------------	---	---	--	--	--	--

▶ **For Parallel BCD Output Option OP-01**

F-30	Output Logic	●	●	●	●	●	●
------	--------------	---	---	---	---	---	---

▶ **For Serial Interface Option OP-04**

F-31	Baud Rate	●	●	●	●	●	●
F-32	Data Format	●	●	●	●	●	●
F-33	Print Output Mode	●	●	●	●	●	●

 **Function Error**

"Err 1" When a function number which does not exist has been set
 "Err 2" When data out of the range has been input

An error is displayed for about 2 seconds and the function number input standby state is created.

F-Functions

F = Initial Factory Setting

F-Functions 1 to 7

F - 1 Buzzer

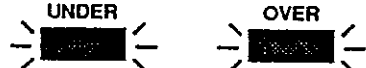
0	Buzzer OFF.	
1	Buzzer ON with ACCEPT.	ACCEPT 
F 2	Buzzer ON with UNDER or OVER.	UNDER OVER 

F - 2 Buzzer Sound Time Length

F 0	Buzzer ON until BUZZER STOP key is pressed.	 BUZZER STOP
1 to 999	Buzzer ON length, each 1 = 14ms. For example: a setting of 71 would sound the buzzer for 1 second, a setting of 355 would sound the buzzer for 5 seconds.	

F - 3 Front Panel Key Lock-Out

F 111111 to 000000
When dip-switch S4 on the front panel is turned ON, any of the six main front panel keys can be locked-out (will not operate when pressed). To select which keys will be locked-out, change the keys corresponding "1" setting to "0" ("0" = locked-out).

In this example: the key lock-out has been set so that when dip-switch S4 is turned ON, the **ZERO** key will not operate when pressed.

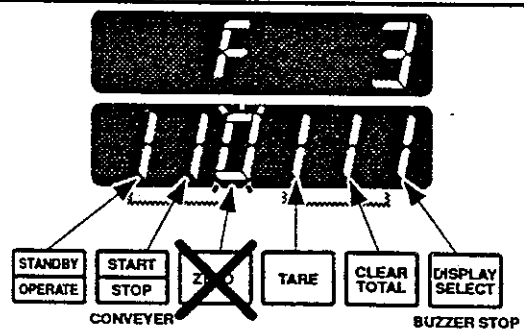
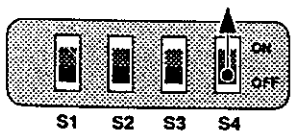

F-4 ENTER Key Lock-Out

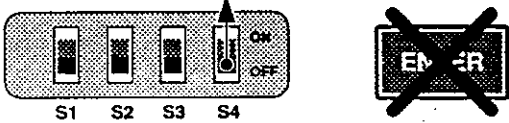
0	<p>ENTER key is locked-out: when dip-switch S4 on the front panel is turned ON, the ENTER key will not operate when pressed. This setting prevents the changing of TARGET weight, UPPER and LOWER LIMITS.</p>
	
1	<p>The ENTER key will operate when dip-switch S4 on the front panel is turned ON. This setting allows changing of TARGET weight, UPPER and LOWER LIMITS, even though some other key may be locked-out with F-Function F-3.</p>

F-5 TARGET / LIMIT's Settings Input

<p>Have the LIMIT setpoints as either: 11 digits for TARGET weight, UPPER and LOWER LIMITS – or 10 digits for just UPPER and LOWER LIMITS.</p>	
1	<p>11 digits for TARGET weight, UPPER LIMIT and LOWER LIMIT.</p> <div style="text-align: right; padding-right: 20px;"> <p>TARGET</p> <div style="border: 1px solid black; padding: 5px; display: inline-block; margin-bottom: 10px;">54321</div> <div style="border: 1px solid black; padding: 5px; display: inline-block; margin-bottom: 10px;">321321</div> <p> LOWER UPPER </p> </div>
2	<p>10 digits for UPPER LIMIT and LOWER LIMIT.</p> <div style="text-align: right; padding-right: 20px;"> <p>Upper Limit</p> <p>TARGET</p> <div style="border: 1px solid black; padding: 5px; display: inline-block; margin-bottom: 10px;">54321</div> <div style="border: 1px solid black; padding: 5px; display: inline-block; margin-bottom: 10px;">54321</div> <p> LOWER UPPER </p> <p>Lower Limit</p> </div>

F - 6

Hi/Go/Lo Output Pause Timer

<p>0 to 999</p>	<p>The time period from the completion of JUDGEMENT to the output of the comparator HI, GO or LO results: each / = 14ms. Range: 0 → 14 seconds.</p> <p>For example: a setting of 7 / would pause for 1 second, a setting of 355 would pause for 5 seconds.</p> <p>Ⓢ Factory setting is 120 or 1.68 seconds.</p> <p><i>Not available for Check Modes 1, 3, 4 or 5.</i></p>
-------------------------	--

F - 7

Hi/Go/Lo Output Length Timer

<p>0</p>	<p>Comparator output is ON until the next JUDGEMENT is made.</p>
<p>1 to 999</p>	<p>The time period (length) for the comparator HI, GO or LO output: each / = 14ms. Range: 0.014 → 14 seconds</p> <p>For example: a setting of 7 / would send for 1 second, a setting of 355 would send for 5 seconds.</p> <p>Ⓢ Factory setting is 100 or 1.4 seconds.</p> <p><i>Not available for Check Mode 5.</i></p>

⚡ F-Functions 01 to 33

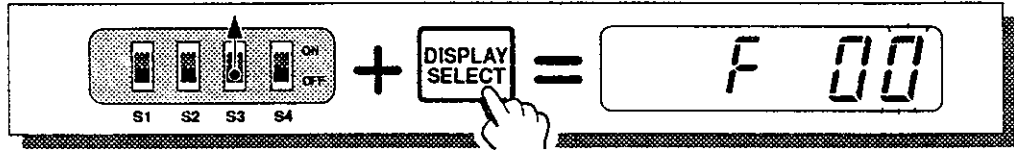

F-01

Decimal Point Position

0	No Decimal Point.	12345	kg pcs
1	10 ¹	1234.5	kg pcs
2	10 ²	123.45	kg pcs
ⓐ 3	10 ³	12.345	kg pcs
4	10 ⁴	1.2345	kg pcs

F-02

Motion Detection Time

⚠ Use in conjunction with F-03. If F-03 is set at '0' then both are disabled.

This modifies the 'stable' condition by the counts (see F-03) per time of non-movement before the AD-4324 recognizes the stable condition. The fewer counts (F-03) per longer time are more likely to recognize the stable condition (vice versa).

1	0.5 second (more accurate).
ⓐ 2	1 second (less accurate).

F-03

Motion Detection Width (Counts)

This modifies the 'stable' condition by the counts per time (see F-02) of non-movement before the AD-4324 recognizes the stable condition. The fewer counts per longer time (F-03) are more likely to recognize the stable condition (vice versa).
If you are using Check Mode 5: do not set to "0" – Judgement would start before a item is fully placed on platform, giving the results of almost zero.

0	Always Stable (no counts).
1 to 9	1 count (less accurate) ⓐ 2 counts (factory setting) ... 9 counts (more accurate)

F-04

ZERO Tracking Time

⚠ Use in conjunction with F-05. If F-05 is set at '0' then both are disabled.

This function, along with F-05 (width), controls the Automatic ZERO Tracking Compensation (rate of drift from ZERO). The function will automatically bring the display back to zero when there are normal weight fluctuations caused by normal use (see example below).

1	1 second.
2	2 seconds.

For example: Packing fill collects between the weighing conveyor rollers throughout the day. Within the limits you set, the AD-4324 will ignore the fill and automatically bring the display to "zero" for easier weighing. So, if your max. capacity = 10.000kg, min. div. = 1D (0.001kg) and you set F-04 at "1" and F-05 at "2" (2x0.5D = 1D) - every second the AD-4324 will check if more fill than 0.001kg (1D) has collected. If it's less, then the display will automatically "zero". If it's more, it will not - you will have to press the ZERO key, and the cycle will start again at the new "zero".

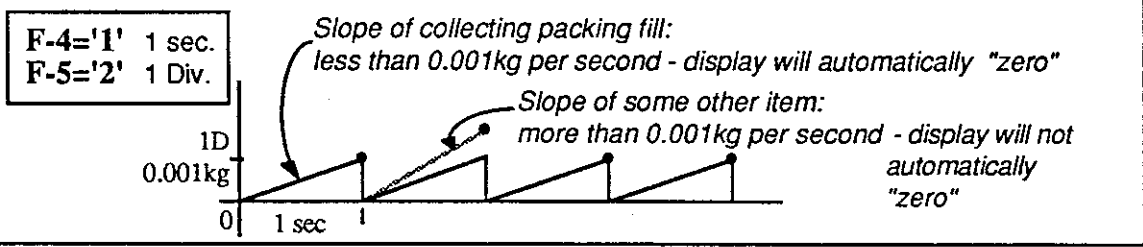

F-05

ZERO Tracking Width

This function, along with F-04 (time), controls the Automatic ZERO Tracking Compensation (see example above).

0	Disabled.
1 to 9	0.5 Divisions (1 x 0.5 Div) 1 Division (2 x 0.5 Div) ... 4.5 Divisions (9 x 0.5 Div)

F-06

Set ZERO Range

Set so **ZERO** key works only if the display is within the set $\pm 2\%$ or $\pm 10\%$ limit of the weighing platform Full Capacity.

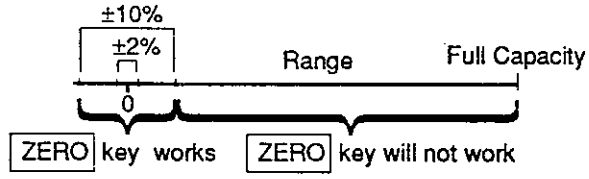

1	$\pm 2\%$ of weighing platform Full Capacity.
2	$\pm 10\%$ of weighing platform Full Capacity.

F-07 ZERO and TARE Key Availability

0	ZERO and TARE keys work if the display is stable or unstable.
① 1	ZERO and TARE keys work <i>only</i> when display is stable.

F-08 ZERO Band (Output B7)

⚠ If F-09 is set at '0' then F-08 is disabled.

① 000000 to 500000	Input the weight where if the reading is below it, the AD-4324 will send the 'ZERO' signal B7. Example: if capacity is 10kg (1D) and this is set to 000000 1 then when the displayed weight falls below 1g, 'ZERO' signal B7 will come ON.
--------------------------	---

F-09 ZERO Band Judgement

0	No ZERO Band Judgement is made.
① 1	ZERO Band Judgement is made (signal comes ON when below weight set in F-08).

F-10 Judgement Sampling Rate

1 to 99	Time that object is sampled for Judgement, each 1 = 14ms. See F-14 for more information. ① Factory setting is 25 or 0.35 seconds.
---------------	--

F-11 Digital Filter



This function is weighing environment dependent. When fast weighing is needed, then the filter should be weaker for a faster display response.

1 to 5	1 = weakest ① 4 = Normal 5 = Strongest	<table border="0"> <tr> <td>Good Environment</td> <td>1</td> <td>More Sensitive</td> </tr> <tr> <td></td> <td> </td> <td></td> </tr> <tr> <td>Bad Environment</td> <td>5</td> <td>Less Sensitive</td> </tr> </table>	Good Environment	1	More Sensitive				Bad Environment	5	Less Sensitive
Good Environment	1	More Sensitive									
Bad Environment	5	Less Sensitive									

F - 12

Mode 0/1 RUN Digital Filter

This function is for weighing environment dependent. Use to compensate for vibration or noise. When you increase the filter strength, the response time becomes slower.

1 to 5	/ = weakest ● 3̄ = Normal 5 = Strongest	Good Environment  Bad Environment	More Sensitive  Less Sensitive
--------------	---	---	---

F - 13

Mode 0/1 RUN Gravity Comp.

This function is used for gravity compensation while the weighing platform is weighing and the conveyor is running. An item weighs slightly less when in motion, so this feature is more useful with lighter items, or when high accuracy is needed. Compensation is applied to the TARGET weight.

0.9000 to 1.1000	Take the weight of an item and divide by its weight on the run. Enter that number. Example: Item weighs 12.345kg, and on the run it weighs 12.340kg. $12.345 \div 12.340 = 1.0004$. You would set this function at 1.0004. ● Factory set at 1.0000 or the same as TARGET.
------------------------	--

F-14

Modes 0, 1, 2, 3 Placement Timer

This F-Function controls the amount of time: after the location detection signal (A1) has been activated* until the item is correctly situated for **JUDGEMENT**:

Modes 0 & 1 – Time for item to become correctly placed on platform (*also see F-16).

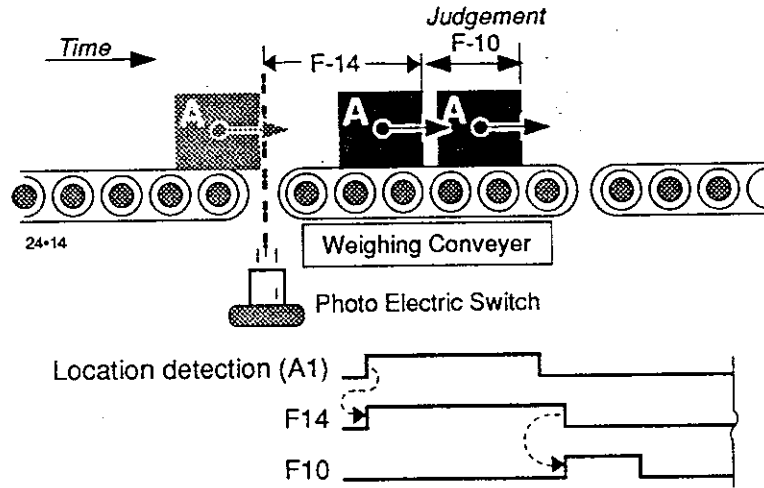

Modes 2 & 3 – Time to placement and stability is achieved.

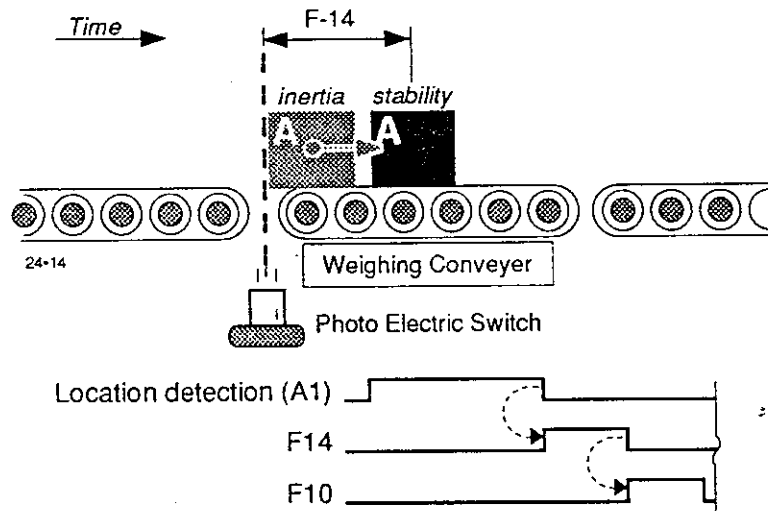

<p>0 to 999</p>	<p>Placement time after A1 signal, each = 14ms. Range: 0 → 14 seconds</p> <p>⊕ Factory setting is 150 or 2 seconds</p>
-------------------------	--

F - 15**Mode 4 Conveyor Run Timer**

This F-Function controls the amount of time in Mode 4 that the weighing platform conveyor runs after the location detection signal (A1) has been received (usually the amount of time it takes for an item to move completely off the weighing platform conveyor). If the result is **NO GO**, then the display will be held.

0	No conveyor stop.
1 to 999	<p>Conveyor run after A1 signal, each 1 = 14ms. Range: 0 → 14 seconds.</p> <p>For example: a setting of 355 would run the conveyor for another 5 seconds, a setting of 710 would run it another 10 seconds.</p> <p>ⓐ Factory setting is 70 or 2 seconds</p>

F - 16**Mode 0/2 Error Stop**

0	No stop.
1	Stop on Error.

F-17

Modes 0/1 A1 Start OFF or ON

This function controls whether the location detection signal (A1) ON or OFF starts F-14, Placement Timer. *Concept:*

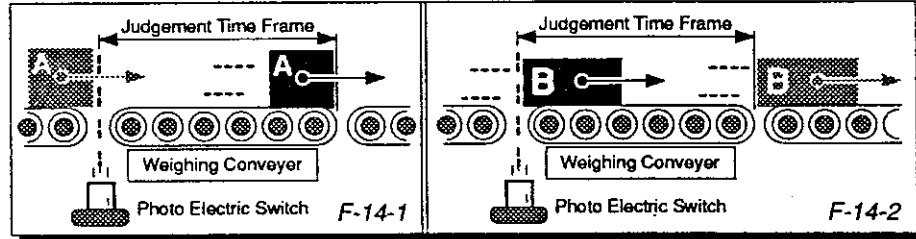

1 A1 ON starts Placement Timer F-14. This is for normal objects that are consistent in the amount of time to load on the weighing conveyor (they don't slip or twist around).

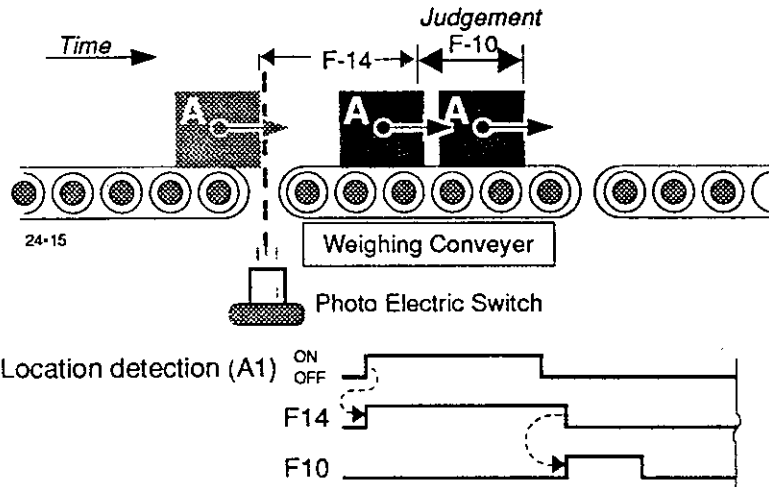

2 A1 OFF starts Placement Timer F-14. This is for slippery objects or others that are NOT consistent in the amount of time they take to be on the weighing conveyor (or for longer items). This way the AD-4324 knows the item is completely on the weighing conveyor, before starting F-14.

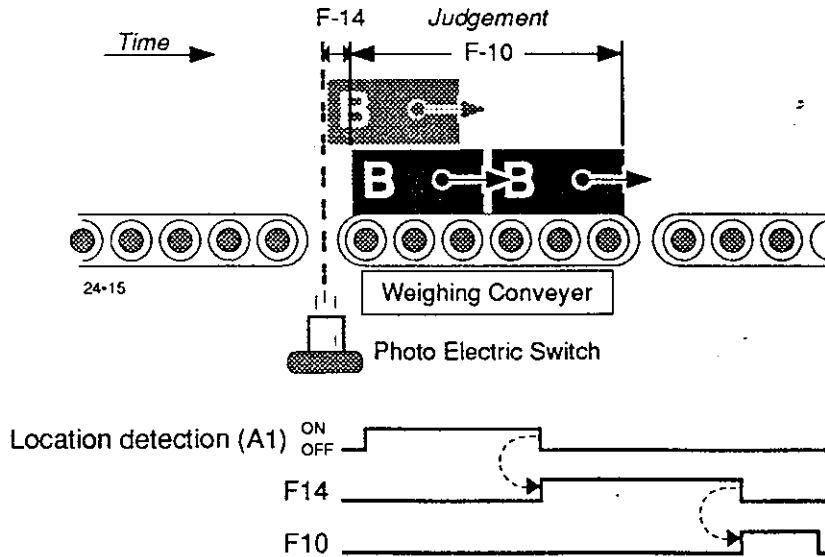

F-18

Code

0	Not Using Code	Code number is not displayed even if the DISPLAY/SELECT key is pressed.
1	Using Code	"Code **" will be displayed each time pressing the DISPLAY/SELECT key and you can recall the setting value assigned for each code number.

F-19

Weighing Unit

When the unit is set, it is the unit output through the serial output or serial interface option OP-04. Please use the stickers inclosed to change the 'kg' mark to the proper unit weight.

	SER. OUT & OP-04 Serial format		OP-01 BCD output	
0	No unit (no output).		FF	
1	kg	lb (USA version only)	28	FF (USA)
2	g	oz (USA version only)	F8	FF (USA)
3	t	kg (USA version only)	BF	28 (USA)
4	lb	g (USA version only)	FF	F8 (USA)
5	oz	↑ (USA version only)	FF	BF (USA)

For the Standard Serial Output (SER. OUT)

F-20

Baud Rate

1	600 bits per second.
2	2,400 bits per second.

F-21

Data Format

1	Weight Data.
2	Number of weighing events, HI/CO/LO , item weight.
3	Code + Weight Data.
4	Code + Number of weighing events, HI/CO/LO , item weight.

✚ Timer Judgement

F-22 Timer Judgement

This function controls the amount of time a Judgement signal must be ON.

0 to 9	Each / = 14ms. If a Judgement signal duration is less than the time set here, then the Judgement is not performed, and timer starts again at the next Judgement (prevents erroneous Judgements, such as from vibrations) Ⓢ Factory setting is 9
--------------	---

✚ For Parallel BCD Output - Option OP-01

F-30 Output Logic

Ⓢ	1	Positive Logic.
	2	Negative Logic

✚ RS-232C, Current Loop Output — OP-04

F-31 Baud Rate

Ⓢ	1	600 bits per second.
	2	1,200 bits per second.
	3	2,400 bits per second.
	4	4,800 bits per second (RS-232C ONLY).
	5	9,600 bits per second (RS-232C ONLY).

F-32**Data Format**

①	1	Weight Data.
	2	Number of weighing events, HI/CO/LO , item weight.
	3	Code + Weight Data.
	4	Code + Number of weighing events, HI/CO/LO , item weight.

F-33**Print Output Mode**

①	1	Auto-Print.
	2	Command Mode.
	3	Stream Mode.



Initialization

Initializes function data.



With initialization, Zero Calibration, Tare Weight value, Upper/Lower Limit set values and Number of Times are cleared off.

1

- ▶ Confirming that the dip switches (S1-4) are OFF, turn on power switch on the rear panel while pressing **STANDBY/OPERATE** and **START/STOP** keys.

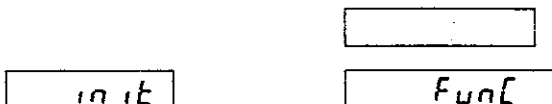

2

- ▶ When **ENTER** is pressed, the initial value is loaded and the Normal mode starts. For the contents to be initialized, refer to the item concerning Function.

3

- ▶ To initialize calibration data, press the **ZERO** key to display the following messages:



4

- ▶ Press **ENTER** . Function data are also initialized.

- When initialization is carried out, perform the calibration procedure again.

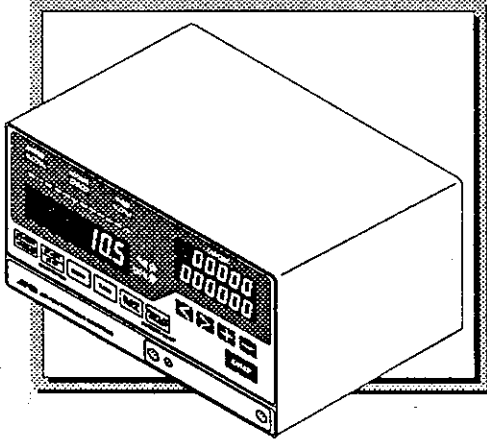

AD-4324 • Section G

Control I/O Standard Serial Output



CONTROL I/O



The Control I/O connector on the rear panel (see page A-10 34) can 1. Send commands to operate weighing equipment or comparator displays and 2. Receive signals such as the Location Detection or external keyboard commands.

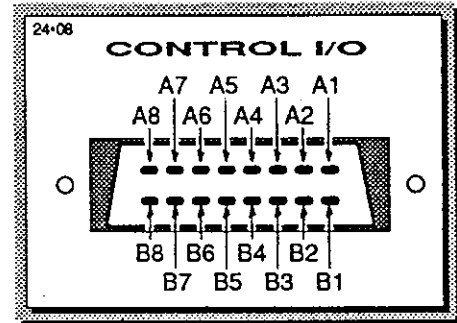

Input

PIN	SIGNAL NAME	DESCRIPTION
A-1	Location Detection	Location Detection timing signal (see F-14, 15).
A-2	START / STOP (RUN modes)	} Same as front panel keys
A-3	ZERO	
A-4	TARE	
A-5	CLEAR TOTAL	
A-6	DISPLAY SELECT	
A-7	N.C.	Do not connect anything to this pin
A-8	Common	

24-09



Output

PIN	SIGNAL NAME	DESCRIPTION
B-1	RUN Output	Conveyor ON/OFF, RUN mode
B-2	OVER Output	ON when UPPER LIMIT is exceeded (RUN mode only)
B-3	ACCEPT Output	ON when in TARGET range (RUN mode only)
B-4	UNDER Output	ON when LOWER LIMIT is exceeded (RUN mode only)
B-5	ERROR Output	ON when error occurs
B-6	Motion detection Out	ON when weight is in motion
B-7	Zero band Output	ON when gross weight is below the F-08 set value
B-8	N.C.	Do not connect anything to this pin

Circuits

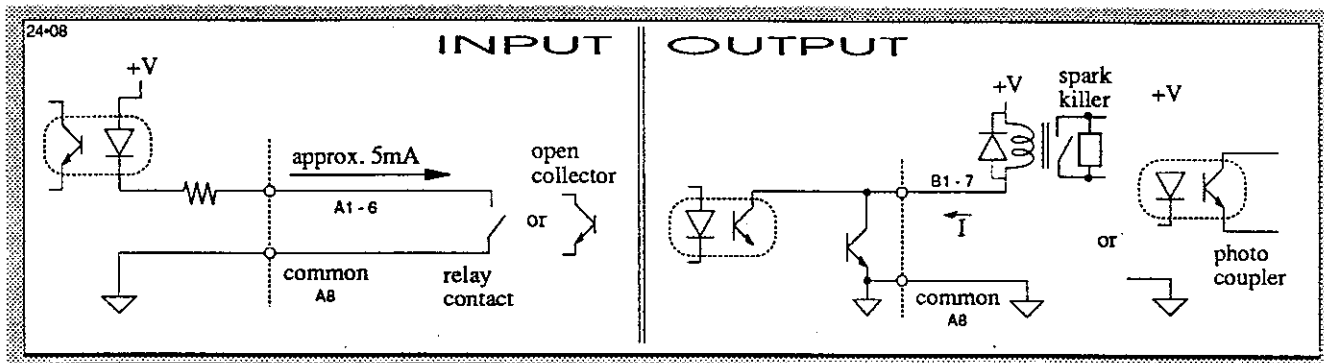

- ❑ The INPUT circuit is operated by a short. The width of these input pulses should be least 200msec, the interval is at least 100msec.
- ❑ With the above OUTPUT circuit, please use optical isolator, relay or solid state relay (SSR).
- ❑ The excitation (or driving) capacity of these relays are 12 to 24V 50mA DC.

Control I/O Notes

- 1 Output time on B-2, B-3, B-4 are set by F-Functions F-6 and F-7 (pages F-9).
- 2 Output time on B-7 is set by F-Function F-08 (page F-12).

Serial Output (SER. OUT)



The Serial Output connector on the rear panel (see page A•1005 marked SER. OUT) can send weighing data to a printer or external display.

Specifications

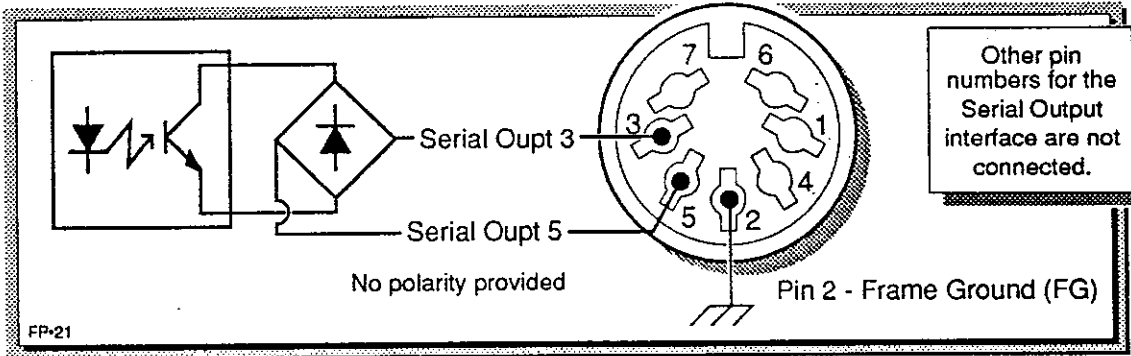

FP-21

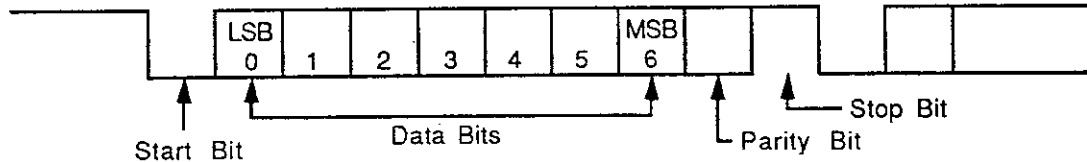

20mA Cur. Loop	
1	= 20mA
0	= 0mA

⊃ Data format is the same as the serial output of option OP-04, see page H•9.

Serial Output Notes:

- 1 Data is output once, after a weighing judgement is made.
- 2 For A&D's printers AD-8117/8117A, use printer cable AD-8117-01.
- 3 When using A&D's printer AD-8117, use printer mode 1.

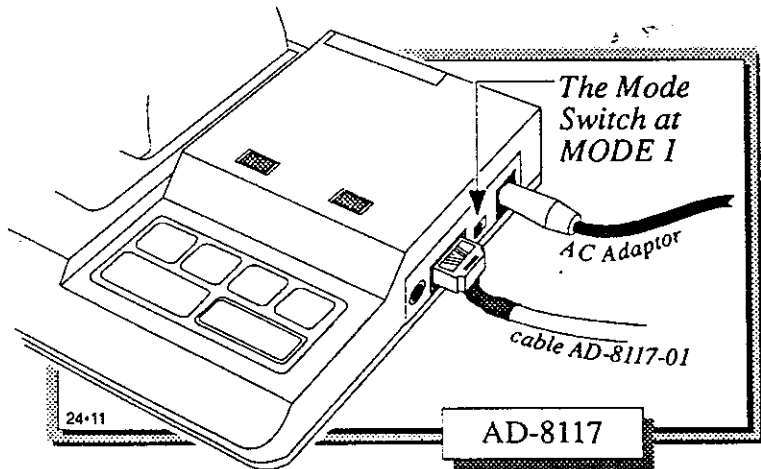

Controlling F-Functions

F-19

Display Weighing Unit

When the unit is set, it is the unit output through the serial output or serial interface option OP-04. Please use the stickers inclosed to change the 'kg' mark to the proper unit weight.

	SER. OUT & OP-04 Serial format	OP-01 BCD output
0	No unit (no output).	FF
① 1	kg <u>lb (USA version only)</u>	28 <u>FF (USA)</u>
2	g <u>oz (USA version only)</u>	F8 <u>FF (USA)</u>
3	t <u>kg (USA version only)</u>	BF <u>28 (USA)</u>
4	lb <u>g (USA version only)</u>	FF <u>F8 (USA)</u>
5	oz <u>t (USA version only)</u>	FF <u>BF (USA)</u>

F-20

Baud Rate

1	600 bits per second.
① 2	2,400 bits per second.

F-21

Data Format

① 1	Weight Data.
2	Number of weighing events, HI/CO/LO , item weight.
3	Code + Weight Data.
4	Code + Number of weighing events, HI/CO/LO , item weight.

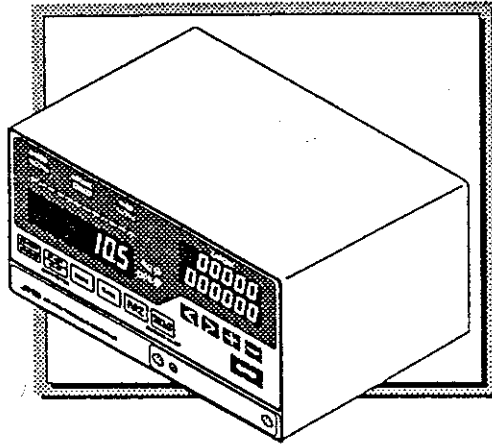

AD-4324 • Section H

Options

- OP-01 Parallel BCD Output
- OP-02 Relay Output
- OP-04 RS-232C Serial Interface

OP-01 Parallel BCD Output



The Parallel BCD Output Connector is for sending weighing data to a printer, display, score board, PLC (Programmable Logic Controller).



Pin Assignment

Pin No.	Signal Name	Pin No.	Signal Name
1	GND	26	Net
2	1	27	
3	2	28	
4	4	29	
5	8	30	Stable
6	1	31	
7	2	32	
8	4	33	
9	8	34	Unit A
10	1	35	
11	2	36	
12	4	37	
13	8	38	Unit B
14	1	39	
15	2	40	
16	4	41	
17	8	42	Polarity (Lo with minus)
18	1	43	Decimal point 10^1
19	2	44	Decimal point 10^2
20	4	45	Decimal point 10^3
21	8	46	Decimal point 10^4
22	1	47	Over
23	2	48	
24	4	49	Print command
25	8	50	Hold input

- 50 pin connector, TTL Open-Collector Output, fan-out 5, positive/negative logic. Pins 2 → 25 are data output.
- When HOLD (pin 50) input is connected to GND (pin1) by an Open-Collector Output or contact closure, output will go to hold.
- Standard Accessory..... Mating connector (1) 57-30500 (Amphenol).

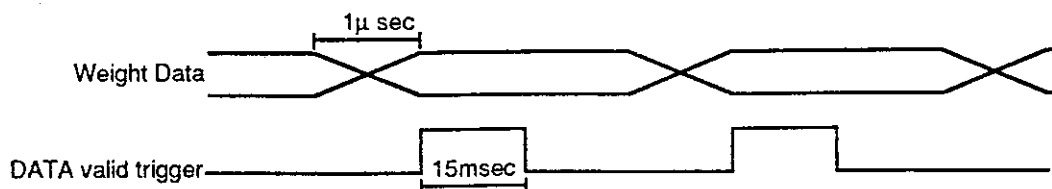

BCD Output Circuit

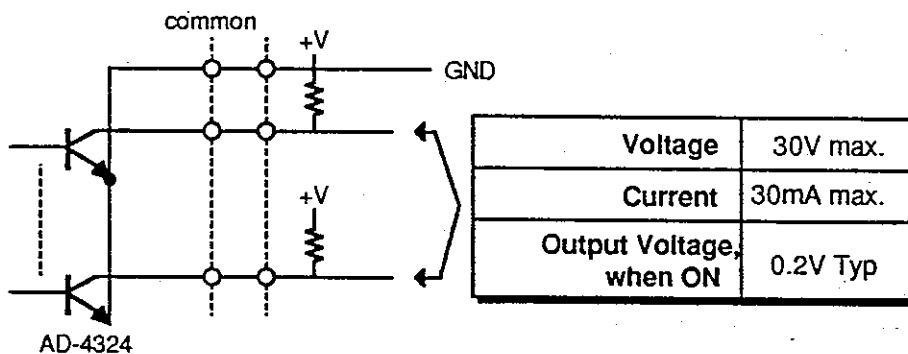

- ❑ The output circuit is an open-collector type. If you hook-up this line to TTL Logic, please add a pull-up resistor.

Hold Input

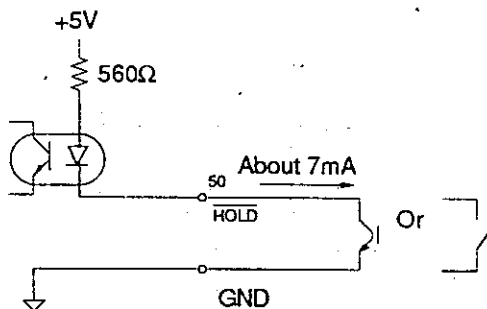

Controlling F-Function

F-30

Output Logic

1	Positive Logic.
2	Negative Logic



OP-02 Relay Output

This option converts the open collector output of the AD-4324 to relay type output. This option requires only one cable to connect it to the AD-4324. All input / output signals are through 5 pin - base connectors. In addition, conveyor motor power can be directly controlled.

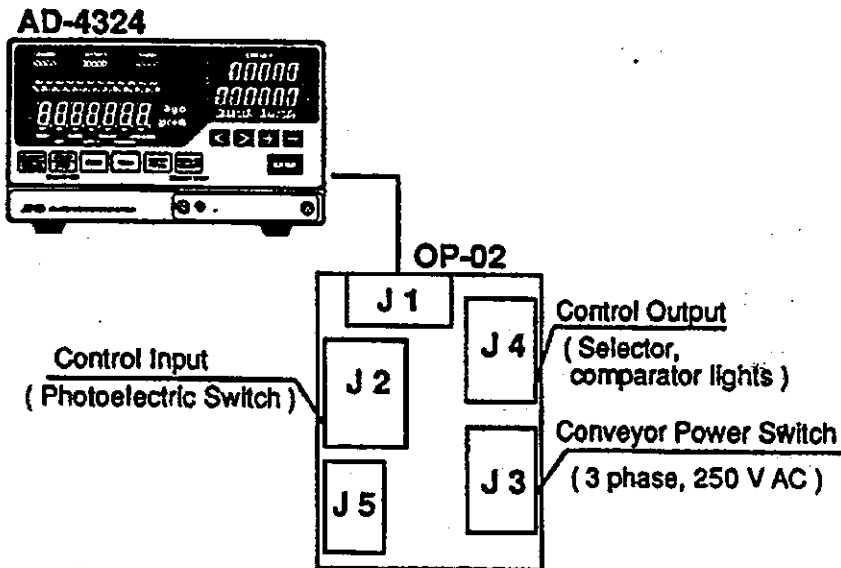

Input / Output Specification

Interface (J 1)

A 1	Location Detection	B 1	RUN
A 2	START/STOP	B 2	OVER
A 3	ZERO	B 3	ACCEPT
A 4	TARE	B 4	UNDER
A 5	CLEAR TOTAL	B 5	ERROR
A 6	DISPLAY SELECT / BUZZER STOP	B 6	STABLE Motion Detection (USA version only)
A 7	N.C.	B 7	Zero Band
A 8	Input / output common	B 8	Power supply

Connected to the AD-4324 main unit "CONTROL I/O" with a 1- to-1 cable.

Control Input (J 2)

IN 1	Location Detection
IN 2	START/STOP
IN 3	ZERO
IN 4	TARE
IN 5	CLEAR TOTAL
IN 6	DISPLAY SELECT / BUZZER STOP
G	GND
12 V	+ 12V (DC 12V, 70mA for photoelectric switch)

Input a non-voltage output of a relay closure, an open collector and so on.

The INPUT circuit is operated by a connection GND.

The width of these input pulses should be at least 200 msec.

The 12 V output can be used for the photoelectric switch power supply (up to 70mA).

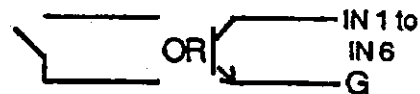
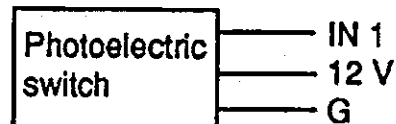
Conveyor Power Supply (J 3)

U 1, V 1, W 1	Conveyor Power Supply Output
U 2, V 2, W 2	Conveyor Power Supply Output
FG	Frame Ground

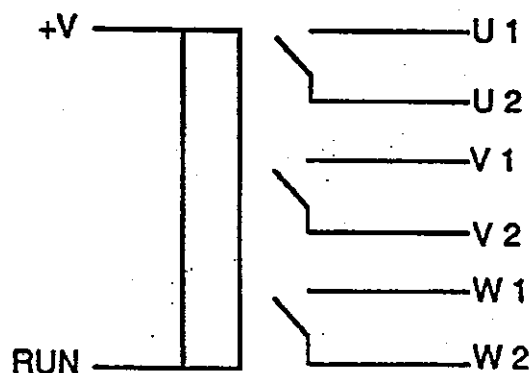

This should be operated at AC 250 V, 1 A or less. Alternately DC 30 V, 1 A or less may be used. The relay points are linked to OUT 1.

AD-4324

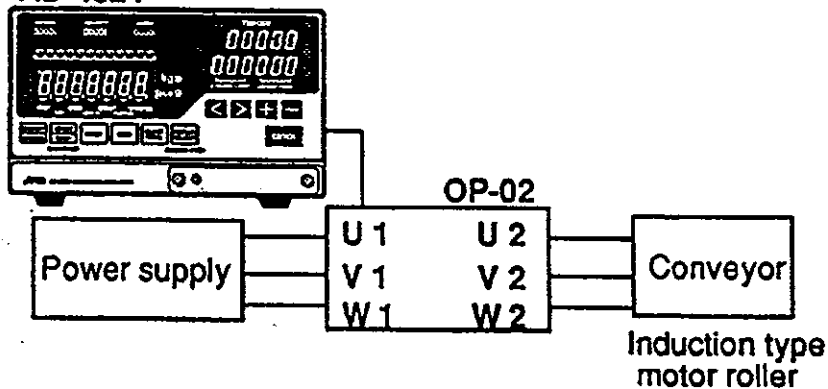

Conveyor Power Supply (J 4)

OUT 1	RUN
OUT 2	OVER
OUT 3	ACCEPT
OUT 4	UNDER
OUT 5	ERROR
OUT 6	STABLE Motion Detection (USA version only)
OUT 7	Zero Band
COM	Power Supply

This should be operated at AC 250 V, or less. Alternately DC 30 V, 1 A or less may be used.

While in operation; OUT 1, OUT 2, and OUT 3 may be connected to common.

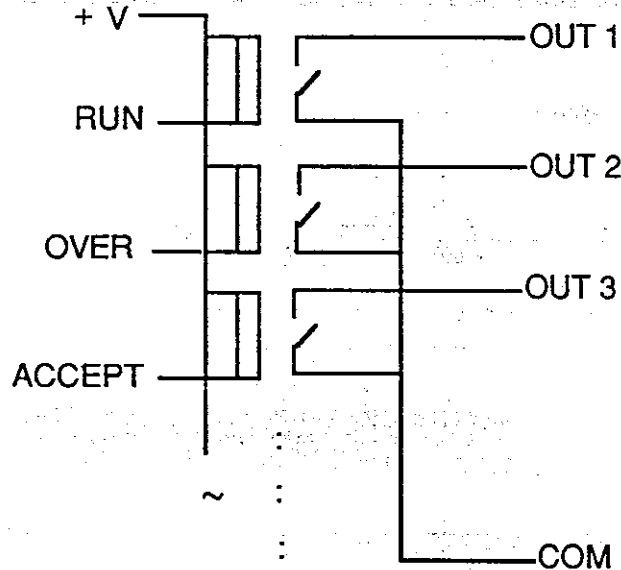

Connection

Use connectors with isolation sleeves.

Route cables through the inside of the guide-posts (to avoid pressure from the upper cover).

Locate the input cable away from noise sources.

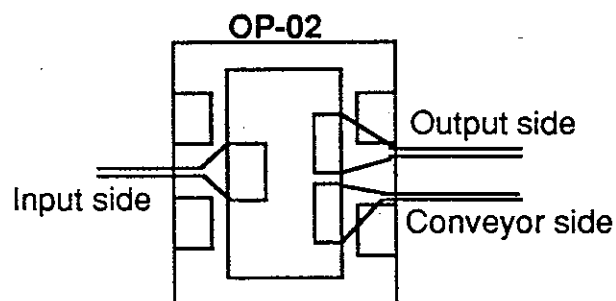

Switch the jumper inside the AD-4324 to supply power for the relay drive.

Disconnect the AD-4324 from AC power prior to starting this procedure.

Remove the 7 screws on the top cover, then slide it 2 cm to the rear panel side and pull it up.

Change the position of JP 1 on the circuit boards to " 1 " and " C ". Put the top cover on.

Reconnect AC power and turn on the AD-4324 power supply.

Press the **START/STOP** key with the display on, and check for the sound of the relay operation.

AD-4324

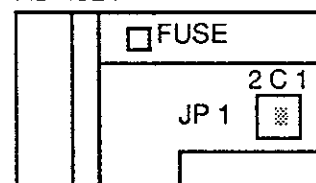

OP-02 Troubleshooting

Relay does not operate?

Interface cable contact failure:

Confirm that all connections are OK and that the cable is not broken.

Fuse:

If the fuse on the AD-4324 main body board is blown, power for relay drive can not be supplied to the OP-02. Check the cause and replace the fuse (0.3A).

Photoelectric switch does not operate?

If power (12V) is not supplied to the photoelectric switch, then the fuse might be blown.

Confirm that fuse (J5) on the OP-02 board is blown. Check the cause and replace the fuse (0.3A).



Devices with different power supply systems cannot be concurrently connected to the control output. Separate the output commons and sub-relay etc.

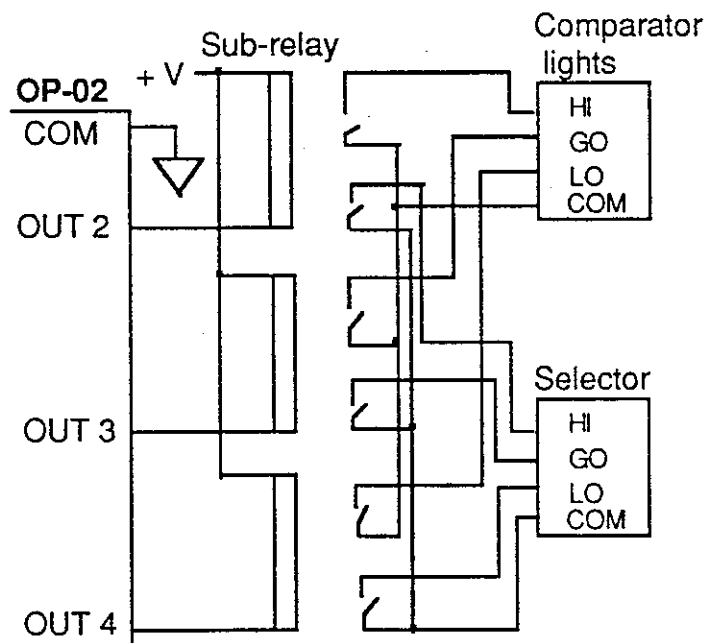



OP-04 RS-232C Serial Interface



Two Connectors are provided with the RS-232C Interface Option; a Current Loop Connector and an RS-232C Connector. The 7-pin Current Loop (four of the pins are not connected) and the 25-pin RS-232C (pins 8 → 25 are not connected) transmit the same data. Only use one of the two ports to connect a computer or other peripheral devices.

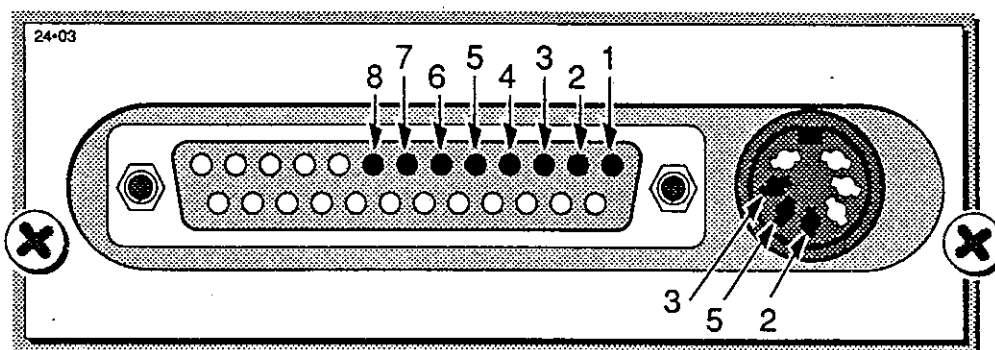

Specifications

Type EIA-RS-232C/Passive 20mA Current Loop.
Method Half-duplex, Asynchronous Transmission, Bi-directional (RS-232C only).
Format Baud rate: 600, 1200, 2400, 4800 and 9600 selectable (do not use 4800 or 9600 with current loop).
Data bit 7
Parity bit 1 Even
Stop bit 1
Code ASCII

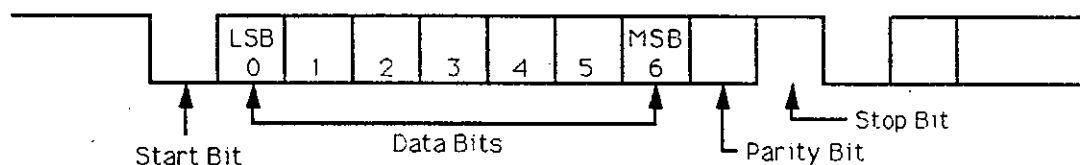

- The connecting cable should be of high quality.

RS-232C	20mA Cur. Loop
1 = -5V → -15V	20mA
0 = +5V → +15V	0mA

RS-232C Pin Connection

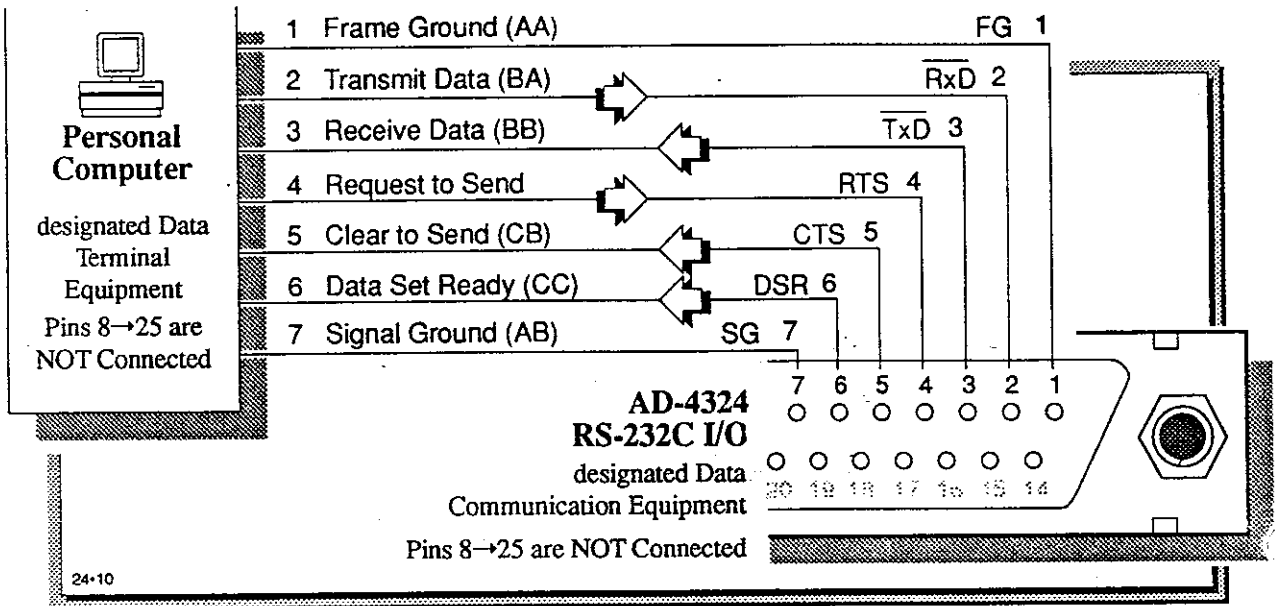

▶ Use a high quality modem type cable between the computer and AD-4324.

Output Circuit Diagram

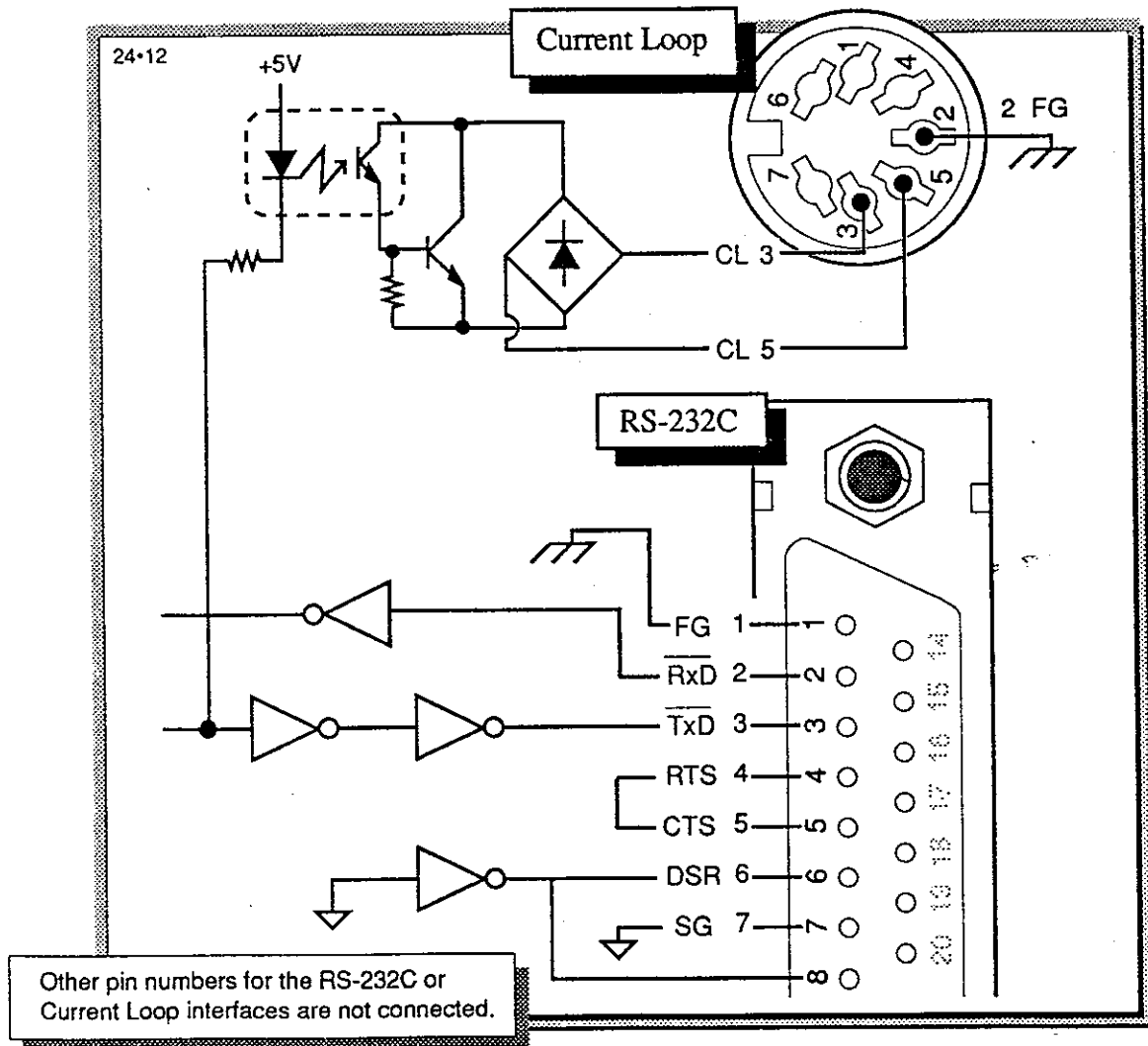

Current Loop Pin Connection

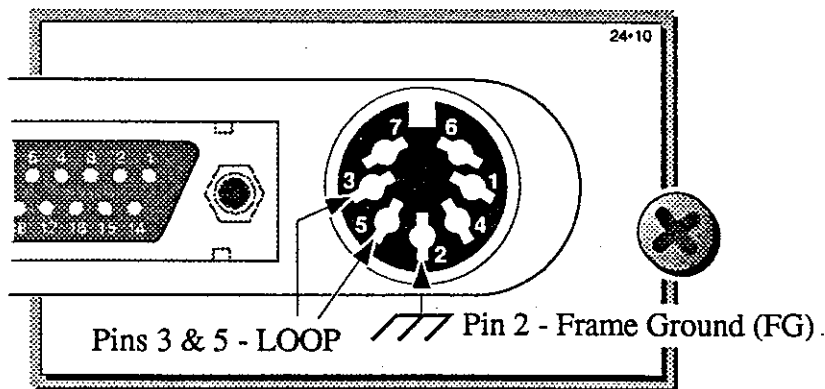

HEX Code Inputs

Space, " " - 20 (HEX)
 Decimal Point, "." - 2E (HEX)
 Minus, "-" - 2D (HEX)
 Plus, "+" - 2B (HEX)

(20H)
(2EH)
(2DH)
(2BH)

The HEX codes for the following relate to your keyboard. Every keyboard is different, and thus each key is given a code. Be sure to enter the correct HEX code when inputting data.

Header 1

When F-32=1:

Overload	O	L
Stable	S	T

When F-32=2:

0	0	0	0	1
to				
9	9	9	9	9

Header 2

When F-32=1:

NET Weight (NET) N T

When F-32=2:

Over UPPER LIMIT	H	I
Within set LIMIT's	G	O
Under LOWER LIMIT	L	O

'F 32' = "1" or "2" with Code Number

C	D	,	2	1	,	S	T	,	N	T	,	+	0	0	0	.	0	0	0	k	g	Ⓒ	Ⓕ	
Ⓕ	Ⓕ		Ⓕ	Ⓕ		Ⓕ	Ⓕ		Ⓕ	Ⓕ		Ⓕ	Ⓕ Data (8 digits in length) Ⓕ								Ⓕ Unit Ⓕ			
CODE			Code #		Header 1		Header 2																	

⚡ 'F 33' = "2" Command Mode (RS-232C ONLY)



To AD-4322A	Command Explanation	AD-4322A Response
R ␣ LF • <u>R</u> EAD•	This is a command to the AD-4324 to read the data and transmit.	If "R" is received, the AD-4324 will send the latest data one time.
Z ␣ LF • <u>Z</u> ERO•	This is a command to the AD-4324 to ZERO the display.	If "Z" is received, the AD-4324 display will ZERO and: Z ␣ LF will be sent by the AD-4324.
T ␣ LF • <u>T</u> ARE•	This is a command to the AD-4324 to TARE the display and go to NET mode.	If "T" is received, AD-4324 will go to NET mode, display will ZERO, TARE annunciator will light and: T ␣ LF will be sent by the AD-4324.
S ␣ LF • <u>S</u> ET•	This is a command to the AD-4324 to be ready to accept new LIMIT's.	If "S" is received, AD-4324 will send S ␣ LF and accept the next as new LIMIT's.
RS ␣ LF • <u>R</u> e <u>S</u> et•	This is a command to the AD-4324 to send present set LIMIT's.	If "RS" is received, AD-4324 will send present set LIMIT's
C ␣ LF • <u>C</u> LEAR•	This is a command to CLEAR the tare display.	If "C" is received, tare display will clear, and: C ␣ LF will be sent by the AD-4324.

- If the commands aren't accepted for any reason: **I** ␣ LF will be sent by the AD-4324.
- If an invalid command is received: **?** ␣ LF will be sent by the AD-4324.

⚡ 'S' UPPER and LOWER LIMITS Setting

- 1 When the 'S' command is received by the AD-4324, it will send 'S' ␣ LF.
- 2 Send the UPPER and LOWER LIMITS in the following form:

If F-5 = '1' .

5	4	3	2	1	3	2	1	3	2	1	␣	LF
└ Target Weight ─┘			└ Lower ─┘			└ Upper ─┘						

If F-5 = '2' .

5	4	3	2	1	5	4	3	2	1	␣	LF
└ Upper Limit ─┘					└ Upper Limit ─┘						

- 3 If the data is accepted, the AD-4324 sends a copy back. If there is an error, then '? ␣ LF' is returned. If the setting can not be changed, then 'I ␣ LF' is returned.

OP-04 Notes

- 1 COMMAND Mode will not work with the Current Loop.
- 2 If a second command is sent before the AD-4324 has sent data from a first command, data may not be sent.
- 3 'Z', 'T', 'C' have the same restrictions on use as the corresponding front keyboard keys. See page A•6, **ZERO**, and **TARE** keys.
- 4 'S' and 'RS' commands respond in the format set by F-5.



The analogue output from Load Cells, and the RS-232C input/output signals, are sensitive to electrical noise. Do not bind these cables together as it could result in cross-talk interference. Please also keep them well away from AC power cables. Keep all cable/coax as short as possible.

Controlling F-Functions

F-31

Baud Rate

1	600 bits per second.
2	1,200 bits per second.
3	2,400 bits per second.
4	4,800 bits per second (RS-232C ONLY).
5	9,600 bits per second (RS-232C ONLY).

F-32

Data Format

1	Weight Data.
2	Number of weighing events, HI/CO/LO , item weight.
3	Code + Weight Data.
4	Code + Number of weighing events, HI/CO/LO , item weight.

F-33

Print Output Mode

1	Auto-Print.
2	Command Mode.
3	Stream Mode.

If 'F - 33' is set to '3', settings of 'F - 31' and 'F - 32' are disabled.

The format for the example is as follows :

- Baud Rate : 9600 bps
- Header : None
- Decimal Point : None
- Unit : None
- Update Rate : 70 times / sec.
- Weight value : Six digits with polarity (positive sign or negative sign),
Net weight

Example :

```
+ 0 1 2 3 4 5 < CR > < LF >
- 0 1 2 3 4 5 < CR > < LF >
```

If the weight value is overloaded, six spaces with polarity may be sent.

Example :

```
±                < CR > < LF >
```

A '5' will be appended immediately after the polarity sign to show where the AD-4324 started averaging from.

The AD-4324 starts averaging from this data.

This may be a sign of a judgment timer setting.



```
+ 0 1 2 3 0 0 < CR > < LF >
+ 0 1 2 3 1 0 < CR > < LF >
+ 0 1 2 3 2 0 < CR > < LF >
+ 0 1 2 3 3 0 < CR > < LF >
+ 0 1 2 3 4 0 < CR > < LF >
+ 0 1 2 3 3 0 < CR > < LF >
+ 5 1 2 3 3 0 < CR > < LF >
+ 0 1 2 3 3 0 < CR > < LF >
+ 0 1 2 3 2 0 < CR > < LF >
+ 0 1 2 3 3 0 < CR > < LF >
+ 0 1 2 3 2 0 < CR > < LF >
+ 0 1 2 3 3 0 < CR > < LF >
+ 0 1 2 3 2 0 < CR > < LF >
+ 0 1 2 3 3 0 < CR > < LF >
```



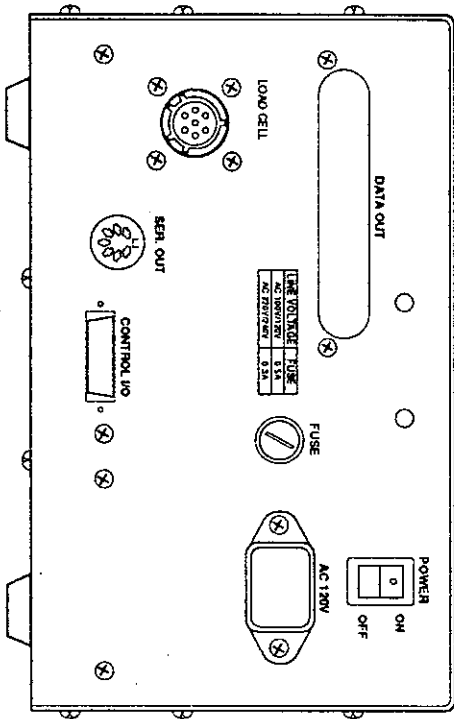

Dimensions

Rear Panel

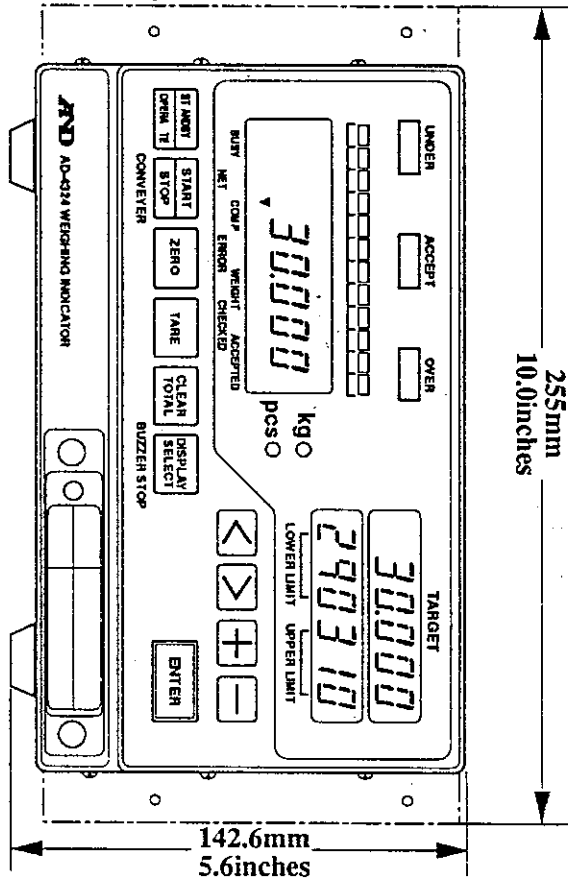

Front Panel



For Mounting

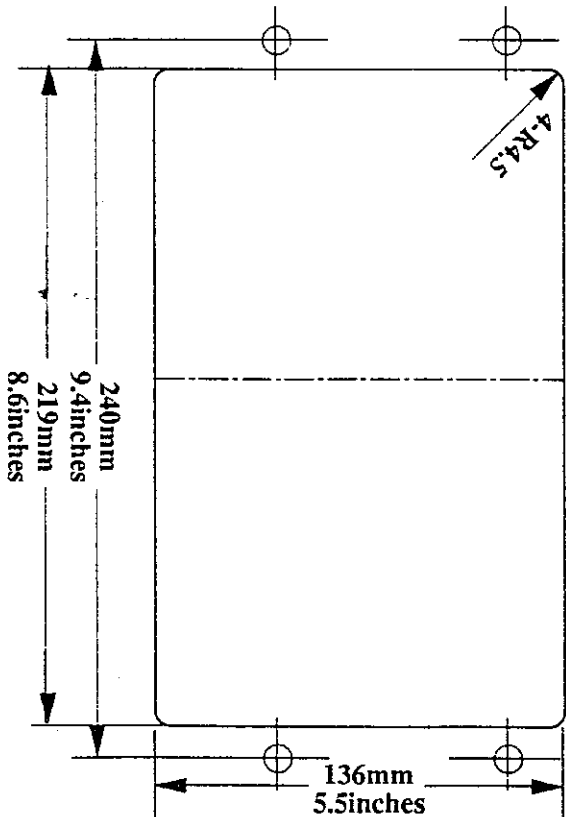

Side View

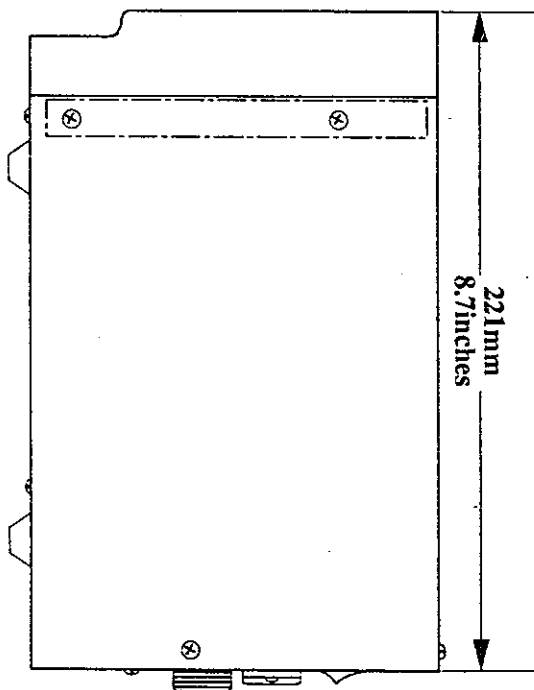

OP-02

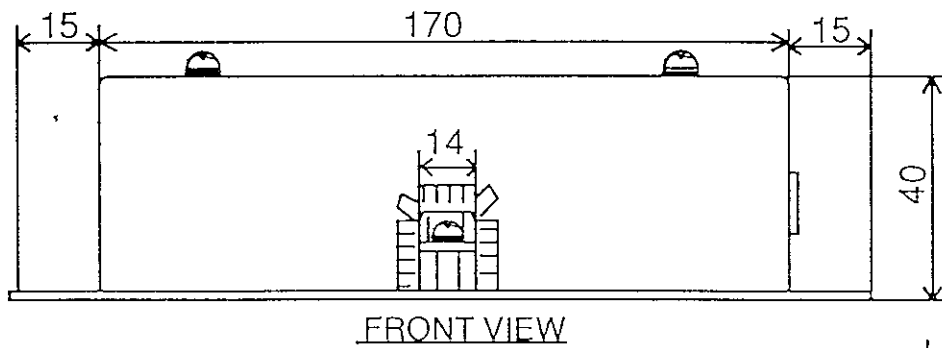
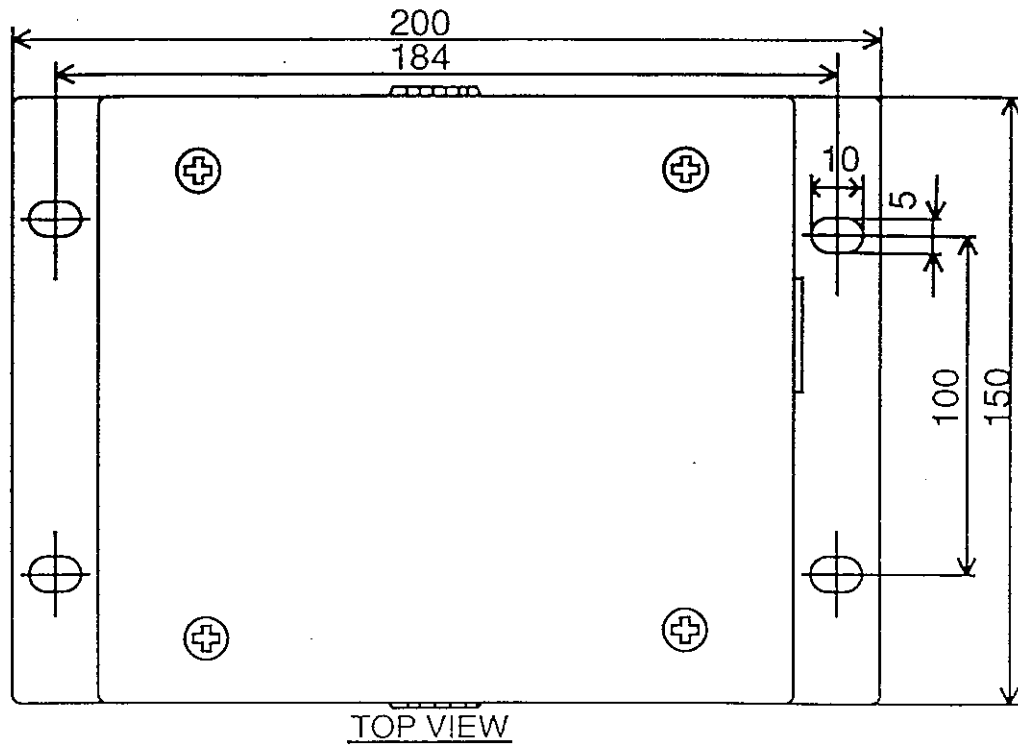

Unit : mm

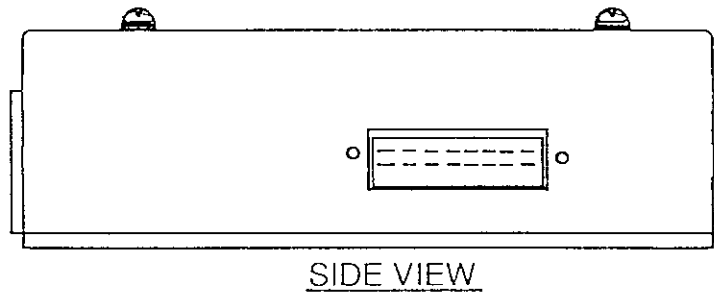



A&D Company, Limited

3-23-14 Higashi-Ikebukuro, Toshima-ku, Tokyo 170 Japan
Telephone: [81] (03) 5391-6132 Fax: [81] (03) 5391-6148 Telex: 2422816 AANDD J

A&D ENGINEERING, INC.

1555 McCandless Drive, Milpitas, CA. 95035 U.S.A.
Telephone: [1] (408) 263-5333 Fax: [1] (408) 263-0119

A&D INSTRUMENTS LTD.

Abingdon Science Park, Abingdon, Oxford OX14 3YS England
Telephone: [44] (0235) 550420 Fax: [44] (0235) 550485

A&D MERCURY PTY. LTD.

32 Dew Street, Thebarton, South Australia 5031 Australia
Telephone: [61] (08) 352-3033 Fax: [61] (08) 352-7409

A&D KOREA Limited

3rd Floor Hanam Bldg 44-27 Yoido-dong Youngdeungpo-ku Seoul, Korea
Telephone: [82] (02) 784-4264 Fax: [82] (02) 784-6557