

SA Series

Portable Bench Scale

INSTRUCTION MANUAL

SA-30K
SA-60K
SA-150K

© 2015 A&D Company, Limited. All rights reserved.

No part of this publication may be reproduced, transmitted, transcribed, or translated into any language in any form by any means without the written permission of A&D Company, Limited.

The contents of this manual and the specifications of the instrument covered by this manual are subject to change for improvement without notice.



CONTENTS

1.	INTRODUCTION	2
2.	FEATURES.....	2
3.	PRECAUTIONS.....	3
3.1.	Precautions for Installation.....	3
3.2.	Precautions for Accurate Weighing.....	3
4.	UNPACKING.....	4
5.	NAME OF INDIVIDUAL PARTS	5
5.1.	Display and Symbols	6
5.2.	Operations and Functions of Keys.....	7
6.	SETTING UP	8
6.1.	Setting up Your Scale.....	8
6.2.	Power Source	8
7.	OPERATION.....	10
7.1.	Turning the Scale ON and OFF	10
7.2.	Basic Weighing	11
7.3.	Changing the Minimum Display	12
8.	DISPLAY HOLD FUNCTION	13
9.	AUTOMATIC ZERO SETTING MODE	14
10.	FUNCTION SETTINGS	15
10.1.	Setting Procedure	15
10.2.	Function List.....	16
11.	CALIBRATION	17
11.1.	Calibration Using a Weight.....	17
11.2.	Gravity Acceleration Correction	19
11.3.	Restoring the Calibration Data to the Default Settings	20
12.	SA-03: RS-232C SERIAL INTERFACE	21
13.	MAINTENANCE.....	25
13.1.	Storing and Cleaning the Scale.....	25
13.2.	Error Codes.....	25
14.	SPECIFICATIONS	26
14.1.	Specifications	26
14.2.	External Dimensions	27
14.3.	Gravity Acceleration Map	28



1. INTRODUCTION

This manual describes how the SA series scale works and how to get the most out of it in terms of performance.

Read this manual thoroughly before using the scale and keep it at hand for future reference.



2. FEATURES

The SA series scales have the following features:

- The thin and compact design allows the scale to be stored in small spaces.
- A handle is provided for easy transportation.
- The displayed contents in the LCD can be rotated 180° for viewing the weighing results from the convenient direction.
- Four minimum displays are available for selection (1 g, 0.001 kg, 0.01 kg, 0.1 kg).
- The backlit LCD provides ease of use even in dark locations.
- The weight value is locked for a certain period after the object to be weighed is placed on the scale. So, reading the weighing results is easy.



3. PRECAUTIONS



3.1. Precautions for Installation

To get the optimum performance from the scale and acquire accurate weighing data, note the following:

- Install the scale on a solid level surface.
- Install the scale in an environment:
 - Where the temperature and humidity are stable and not excessive
 - Where it is free of drafts and vibration
 - Where it is not subject to direct sunlight
 - Where it is not affected by heaters or air conditioners
 - Where corrosive gas, flammable gas or steam is not present
 - Where static electricity does not readily occur.
When the humidity is below 45%RH, insulating materials such as plastics are prone to static electricity due to friction.
 - Where strong magnetic fields or radio waves do not exist
- Allow the scale to reach equilibrium with the ambient temperature before use.
- Installing the scale or storing it for an extended period where the temperature and relative humidity are high and where there may be abrupt changes in temperature may cause scale failure.
- When the scale is installed for the first time or has been moved, refer to “11. CALIBRATION” to calibrate the scale.



3.2. Precautions for Accurate Weighing

- Check the scale periodically to confirm accuracy.
- To maintain accurate weighing performance, a periodic calibration is recommended. (Refer to “11. CALIBRATION.”)
- Do not place an object on the weighing pan that is beyond the weighing capacity.
- Do not drop things on or impact the weighing pan.
- Use your finger to press the keys.
- To avoid weighing errors, adjust zero before each weighing.



4. UNPACKING

When unpacking, confirm the following is included.

- Instruction manual

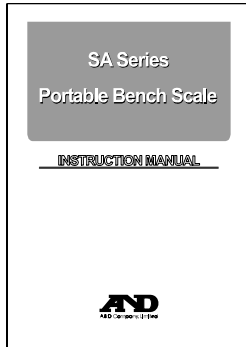

- AC adapter

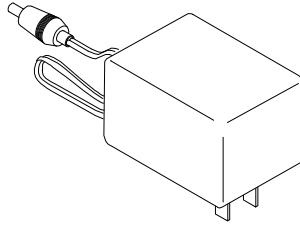

Note
Please confirm that the AC adapter type is correct for your local voltage and receptacle type

- SA series scale (Same for all the models except the key sheet)

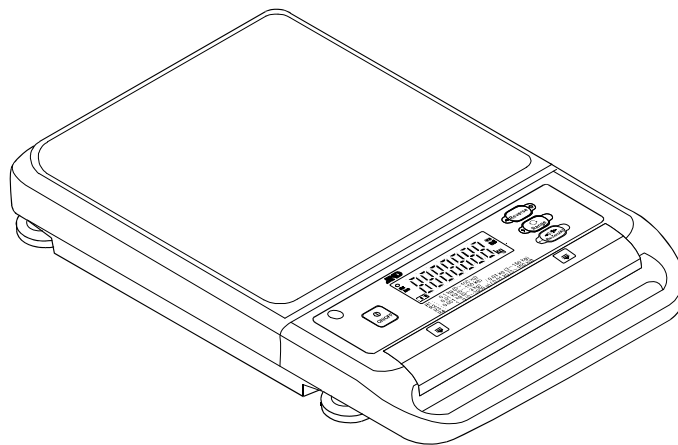



5. NAME OF INDIVIDUAL PARTS

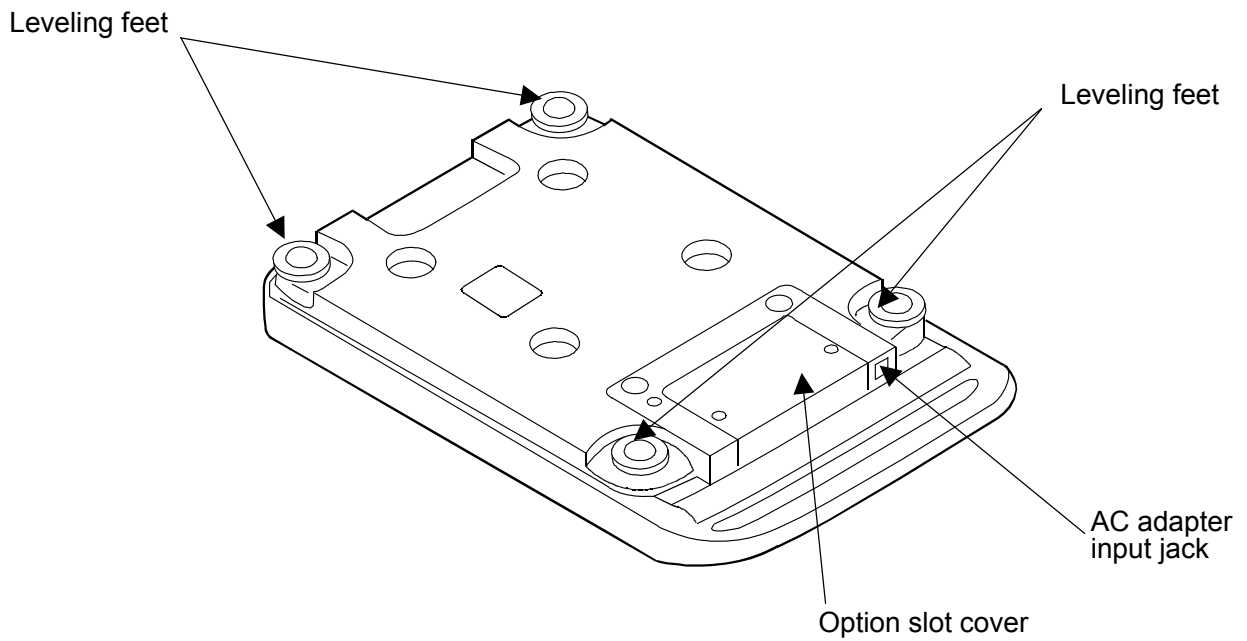
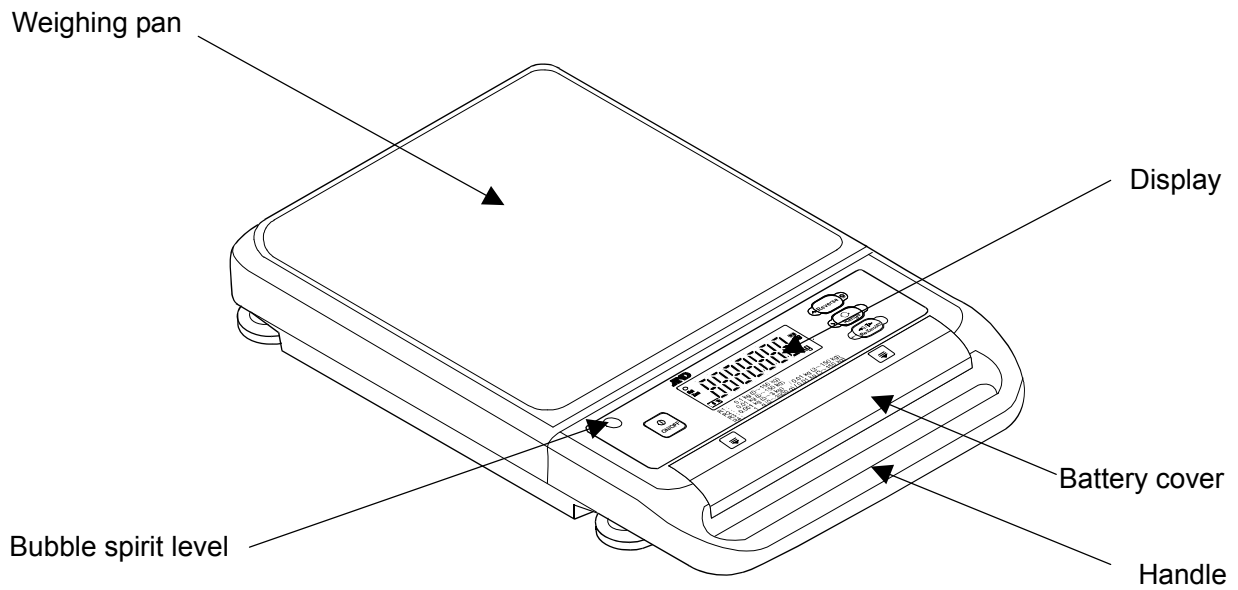



5.1. Display and Symbols

Display

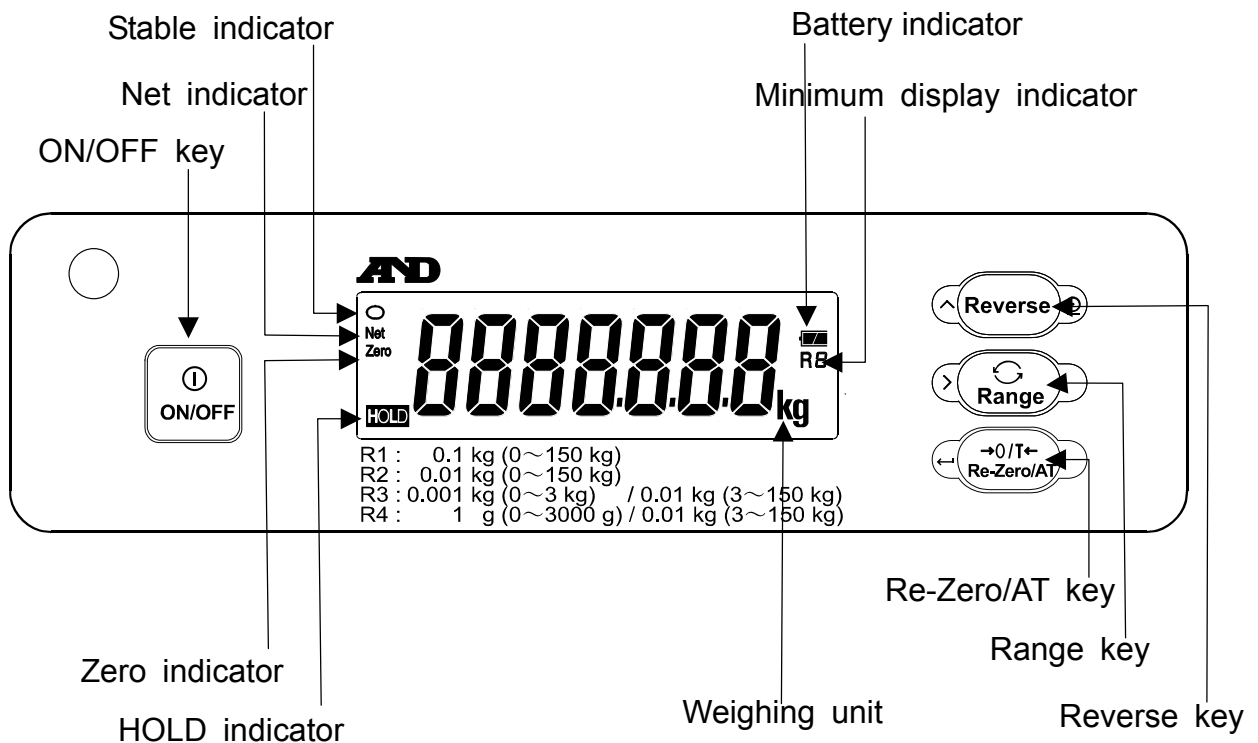



Symbols

Symbol	Description
Stable indicator	Turns on when the weight value is stable and is ready to be read.
Net Net indicator	Turns on when the NET weight is displayed. (The tare operation is in progress.)
Zero Zero indicator	Turns on when zero is displayed.
HOLD HOLD indicator	Turns on when the weight value is locked. Does not turn on when the display hold function is disabled.
Weighing unit	“kg” and “g” are available. Displays the selected unit.
Minimum display indicator	Indicates the minimum display currently selected with “R”+“Number”.
Battery indicator	Turns on when the batteries are used. The battery indicator changes as the battery capacity decreases, as shown below: New → Replace the batteries

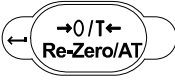

5.2. Operations and Functions of Keys

Key	Description
	<p>ON/OFF key</p> <ul style="list-style-type: none">• Press to turn the scale ON or OFF. When turned ON, the scale will be automatically set to zero.
	<p>Reverse key</p> <ul style="list-style-type: none">• Press and hold to rotate the displayed contents in the LCD by 180°.• Press to change the numerical value of the blinking digit in the function setting mode and the calibration mode. <p>The key also functions as the Print key.</p> <ul style="list-style-type: none">• Press to output the weight value to the printer.
	<p>Range key</p> <ul style="list-style-type: none">• Press and hold to enter the minimum display selection mode. Then, press to select a minimum display. For details, refer to “7.3. Changing the Minimum Display.”• Press to change the parameter in the function setting mode.• Press to shift the blinking digit in the calibration mode.
	<p>Re-Zero/AT key</p> <ul style="list-style-type: none">• Press to set the display to zero.• Press and hold to enter the automatic zero setting mode. When pressed while the scale is OFF, the scale will be turned ON in the automatic zero setting mode. For details, refer to “9. AUTOMATIC ZERO SETTING MODE.”• Press to confirm the setting values in the function setting mode and the calibration mode.



6. SETTING UP



6.1. Setting up Your Scale

1. Refer to “3.1. Precautions for Installation” to set up the scale.
2. Adjust the level of the scale using the leveling feet.
Use the bubble spirit level to confirm. The bubble should be in the center of the circle.

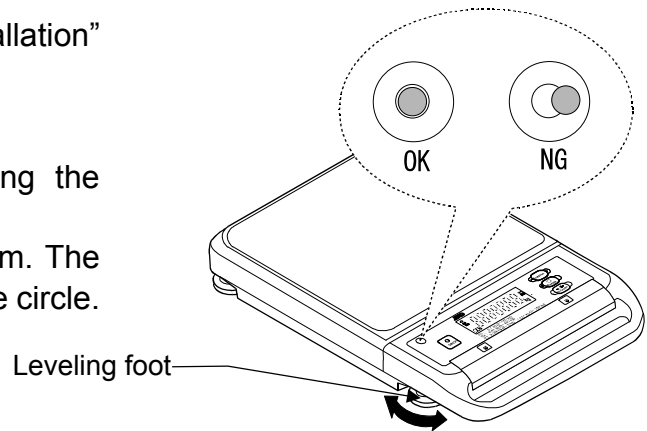

6.2. Power Source

As the power source, the AC adapter or four D (R20 / LR20) batteries are available.

When the AC adapter is used:

Insert the AC adapter plug into the AC adapter input jack located on the underside of the scale.

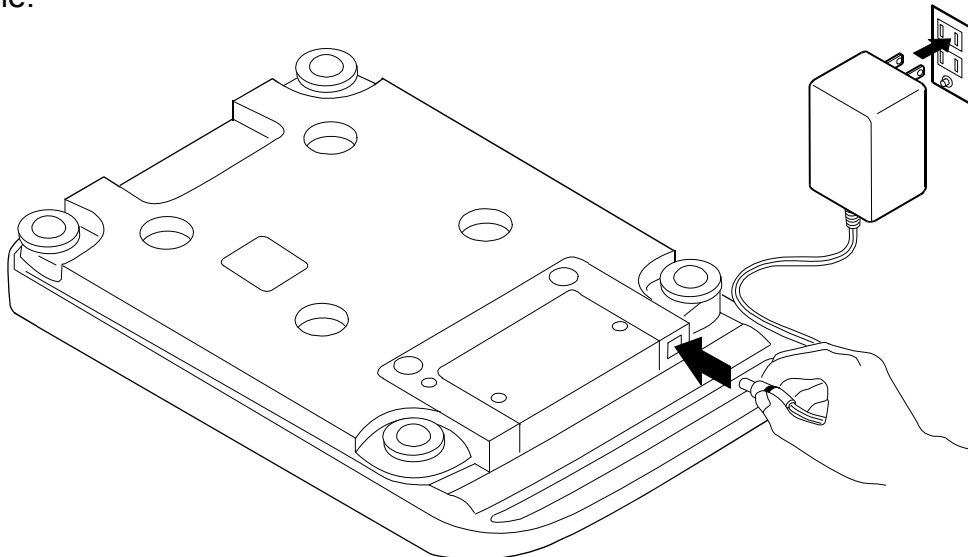

- Use a stable power source.
- Use the AC adapter provided with the scale.

When the batteries are used:

The batteries are not provided and must be supplied by the user.

1. Remove the battery cover located on the front of the display.
2. Insert four new D (R20 / LR20) batteries into the battery compartment after confirming that the battery polarities are correct.
3. Replace the battery cover.

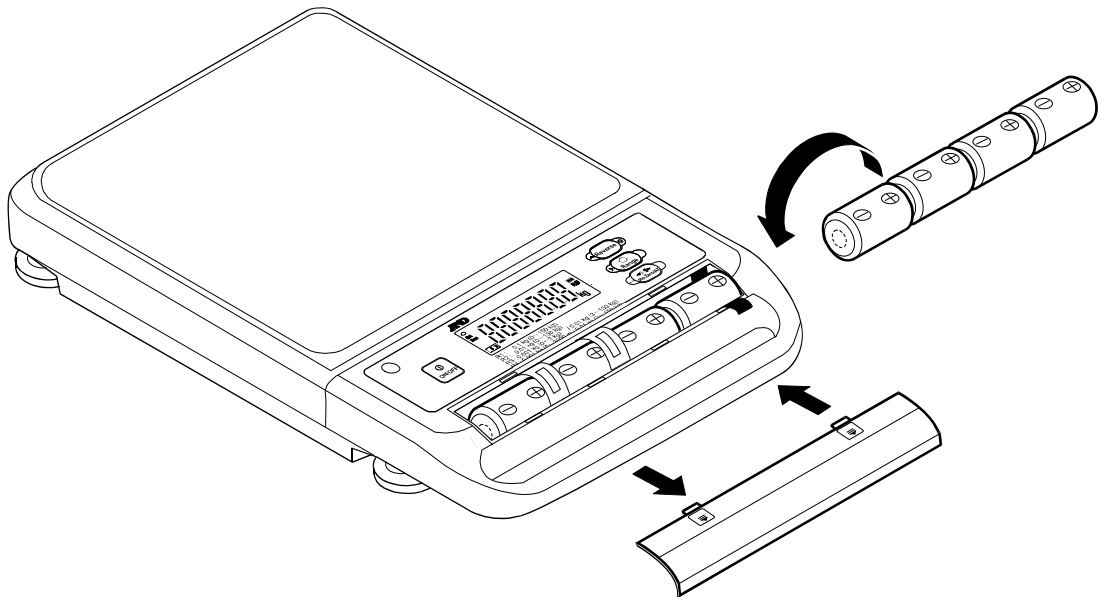

● Precautions on handling the batteries

- Do not handle the batteries with wet hands. Keep the batteries away from moisture.
- Confirm that the battery polarities are correct. The battery polarities are printed in the battery compartment.
- Do not mix old and new batteries or different types of batteries.
It may cause the batteries to leak or burst and may lead to the scale failure
- When the battery indicator changes to , replace the batteries with new ones immediately.
- When “Lb” appears, replace the batteries with new ones immediately.
- The battery life depends on the ambient temperature.
- Remove the batteries if the scale is not to be used for a long time.
The batteries may leak and cause scale failure.



7. OPERATION



7.1. Turning the Scale ON and OFF

1. Press the **ON/OFF** key to turn the scale ON.

All the display symbols turn on and the scale waits for the weight value to become stable.

When the weight value is stable, the Stable indicator (○) turns on and zero is displayed with the Zero indicator (**Zero**) turned on (power-on zero).

If the weight value is not stable, “-----” appears.

Check that nothing is touching the weighing pan and that there are no drafts or vibrations.

When causes are detected, eliminate them.

The range for power-on zero is within $\pm 10\%$ of the weighing capacity around the calibrated zero point.

If the scale is turned ON while there is a load beyond this range, the scale is tared to zero and the Net (**Net**) and Zero (**Zero**) indicators turn on.

- If the scale is required to be turned ON while a certain object is placed on the pan, consider the condition as the initial state and perform zero calibration. When the scale is turned ON next time, the scale will be in the weighing mode. (Refer to “11. CALIBRATION.”)
Please note that the total value of the mass in the initial state and the object to be weighed should be within the weighing capacity.

2. Press the **ON/OFF** key to turn the scale OFF.

- Auto power-OFF function

The auto power-OFF function automatically turns the scale OFF when the weight value is stable and no key operation is performed for a certain period.

To use the function, refer to “10.2. Function List” to set “**P_{OFF}**”.

The auto power-OFF function is enabled in the default setting.



7.2. Basic Weighing

1. Press the **ON/OFF** key to turn the scale ON and wait for the weight value to be stable.
When the display does not show zero, press the **Re-Zero/AT** key to set the display to zero.
 2. When a tare (container) is used, place the container on the weighing pan and press the **Re-Zero/AT** key to set the display to zero.
 3. Place the object to be weighed on the pan or in the container.
Wait for the Stable indicator (○) to turn on and read the weight value.
 4. Remove the object from the pan.
-
- The **Re-Zero/AT** key will zero the scale if the weight value is within $\pm 2\%$ of the weighing capacity around the power-on zero point. The Zero indicator (**Zero**) turns on.
When the weight value exceeds $+2\%$ of the weighing capacity, the scale is tared to zero and the Net (**Net**) and Zero (**Zero**) indicators turn on.
The weighing range is from the zero point to the maximum weighing capacity.
When tared, weighing can be performed up to the weighing capacity minus the tare value.
 - When reading the weight value, confirm that the Stable indicator (○) is turned on.
 - While the HOLD indicator (**HOLD**) is turned on, the weighing result that meets the display hold conditions is locked in the display.



7.3. Changing the Minimum Display

The minimum display can be changed.

The minimum display currently selected is indicated by “R” followed by the number in the LCD.

1. In the weighing mode, press and hold the **Range** key. The unit and the minimum display indicator blink.

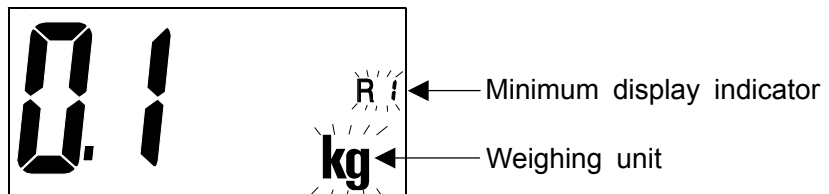

2. Release the **Range** key. Press the **Range** key again to select a minimum display. Each time the **Range** key is pressed, the minimum display changes as shown below:

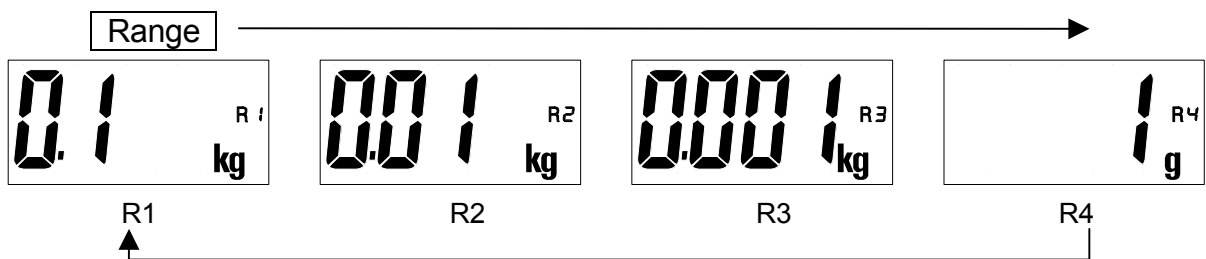

3. Press the **Re-Zero/AT** key to confirm. When no key operation is performed for a certain period, the minimum display currently displayed is confirmed automatically.

R1 ~ R4: Minimum display indicator

Model		SA-30K	SA-60K	SA-150K
Minimum display (d)	R1	0.1 kg	0.1 kg	0.1 kg
	R2	0.01 kg	0.01 kg	0.01 kg
	R3	0.001 kg (0 ~ 3 kg) 0.01 kg (3 ~ 30 kg)	0.001 kg (0 ~ 3 kg) 0.01 kg (3 ~ 60 kg)	0.001 kg (0 ~ 3 kg) 0.01 kg (3 ~ 150 kg)
	R4	1 g (0 ~ 3000 g) 0.01 kg (3 ~ 30 kg)	1 g (0 ~ 3000 g) 0.01 kg (3 ~ 60 kg)	1 g (0 ~ 3000 g) 0.01 kg (3 ~ 150 kg)



8. DISPLAY HOLD FUNCTION

When the weight value meets the display hold conditions, the value is locked in the display.

The HOLD indicator (**HOLD**) is on while the weight value is locked.

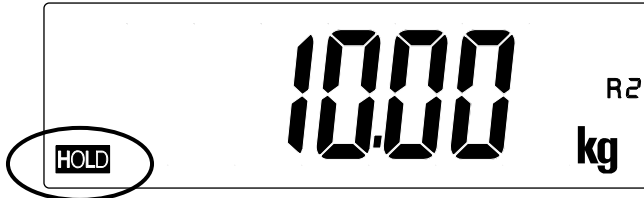

Display hold conditions

When the weight value is greater than 5d and stable, the value is locked in the display.

When the weight value is greater than 5d and is within the “fluctuation range” for two seconds, the value is locked in the display.

Conditions to unlock the weight value

When the weight value changes by ten times the “fluctuation range” or is less than 5d and the “display unlock time” has elapsed, the weight value is unlocked in the display.

- “d”: minimum display.
 - “Fluctuation range” is selected in the function setting “HoLd”.
 - “Display unlock time” is selected in the function setting “Hd-t”.
- For details, refer to “10.2. Function List.”



9. AUTOMATIC ZERO SETTING MODE

When the object to be weighed is placed, the display is set to zero automatically without pressing the **Re-Zero/AT** key.

1. Starting up the automatic zero setting mode

- In the weighing mode
Press and hold the **Re-Zero/AT** key until the weight value starts to blink.
- When the scale is OFF:
Press the **Re-Zero/AT** key.
The scale will be turned ON in the automatic zero setting mode and wait for the weight value to be stable.
Then, the weight value starts to blink.



The buzzer continues to sound while the weight value is blinking.

- ### 2. Place the object to be weighed on the pan.
- When the Stable indicator (○) turns on or the display hold conditions are met, the scale sets the display to zero automatically and returns to the weighing mode.

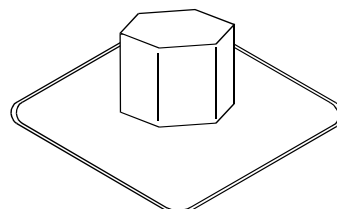

Automatic zero setting ↓

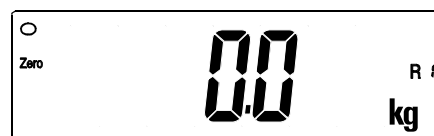

- The condition of the weight value to be set to zero is the same as the **Re-Zero/AT** key performance described in “7.2. Basic Weighing.”
- If the weight value is not stable when starting with the scale OFF, “-----” appears. Take measures as described in “7.1. Turning the Scale ON and OFF.”



10. FUNCTION SETTINGS

The scale has function settings to specify the scale performance.

The parameters set in the function settings are maintained even if the scale is turned OFF.

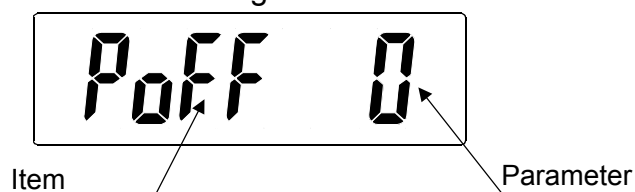

10.1. Setting Procedure

1. While the scale is OFF, press and hold the **Range** key and press the **ON/OFF** key to turn the scale ON.

The software version is displayed.

e.g. : Software version=1.00

While the scale is OFF, press and hold



and press

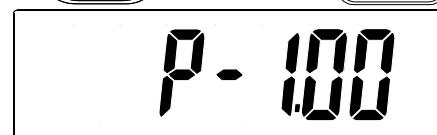
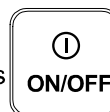

2. Press the **Range** key to display the item.

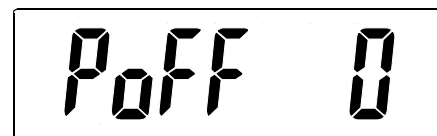

3. Press the **Range** key to change the item.



4. Press the **Re-Zero/AT** key to change the parameter of the item. The parameter blinks.

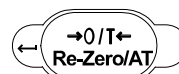

Press the **Reverse** key to increase the value by one.

- “ 0 ” turns on when the parameter currently set is displayed.



5. Press the **Re-Zero/AT** key to confirm the value.

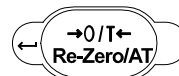



10.2. Function List

Item	Parameter	Description	
Auto power-OFF "P _{OFF} "	0	Auto power-OFF function disabled	Turns the scale OFF automatically when the weight value is stable.
	♦ 1	Turns the scale OFF after 5 minutes	
	2	Turns the scale OFF after 15 minutes	
	3	Turns the scale OFF after 30 minutes	
Auto power-ON "P _{ON} "	♦ 0	Auto power-ON function disabled	When connected to the power source, turns the scale ON automatically.
	1	Auto power-ON function enabled	
Response "C _{OND} "	0	Fast response / Sensitive	
	♦ 1	Standard response / Normal	
	2	Slow response / Less sensitive	
Fluctuation range "H _{OLD} "	0	Display hold function disabled	Select the fluctuation range as the condition to lock the display.
	1	Locks the value only when stable	
	♦ 2	±10d	
	3	±20d	
	4	±50d	
	5	±100d	
Display unlock time "H _{d-t} "	0	Unlocks the display immediately	Select the time (seconds) to be elapsed before unlocking the display.
	1	Unlocks after one second	
	♦ 2	Unlocks after two seconds	
	3-8	Unlocks after three to eight seconds	
	9	Unlocks after nine seconds	
Backlight control "L _{ETUP} "	0	Backlight always off	Turns the backlight off after the specified time of a stable display or no key operation.
	1	Turns off after 5 seconds	
	♦ 2	Turns off after 10 seconds	
	3	Turns off after 30 seconds	
	4	Turns off after 60 seconds	
	5	Backlight always on	
Buzzer "b _{EP} "	0	Buzzer disabled	Sounds the buzzer
	♦ 1	Buzzer enabled	
Zero tracking "t _{rc} "	0	Zero tracking function disabled	
	♦ 1	Zero tracking function enabled	
Decimal point "P _{nt} "	♦ 0	Point (.)	Decimal separator
	1	Comma (,)	
Serial interface Response "R _{CL} "	0	No reply except "Q" command	*Displayed only when the SA-03 is installed.
	♦ 1	Reply to commands	
Data output mode "P _{rt} "	0	Command and stream modes	Auto-print A: +data Auto-print B: +/-data *Displayed only when the SA-03 is installed.
	♦ 1	Key mode / Command mode	
	2	Auto-print A / Command mode	
	3	Auto-print B / Command mode	
	4	Command mode only	
Baud rate "b _{PS} "	♦ 0	2400 bps	*Displayed only when the SA-03 is installed.
	1	4800 bps	
	2	9600 bps	
Data and parity "b _{tPr} "	♦ 0	7 bits, even parity	*Displayed only when the SA-03 is installed.
	1	7 bits, odd parity	
	2	8 bits, non parity	

♦: Default setting "d": Minimum display



11. CALIBRATION

This function adjusts the scale for accurate weighing.
Perform calibration in the following cases

- When the scale is first installed.
- When the scale has been moved.
- When the ambient environment has changed.
- For regular calibration.



11.1. Calibration Using a Weight

- Select a calibration weight according to the accuracy used. A calibration weight is not provided and must be supplied by the user.
- A calibration weight with a value of one half the weighing capacity or more is recommended.

Be sure to start from the following conditions:

- Nothing is placed on the weighing pan.
- The scale is turned OFF.

1. While the scale is OFF, press and hold the **Reverse** and **Range** keys, and press the **ON/OFF** key to turn the scale ON. "CAL" is displayed.

2. Confirm that nothing is placed on the weighing pan. Press the **Re-Zero/AT** key to display "CAL 0". Wait for the Stable indicator (○) to turn on.

3. Confirm the Stable indicator (○) is turned on. Press the **Re-Zero/AT** key to perform zero calibration.

When zero calibration is complete, the calibration weight value is displayed.

- When span calibration is not to be performed, turn the scale OFF to exit from the calibration mode.

While the scale is OFF,
press and hold

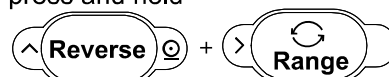

and press **ON/OFF**

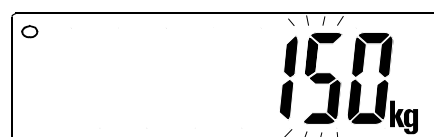
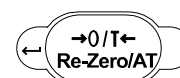
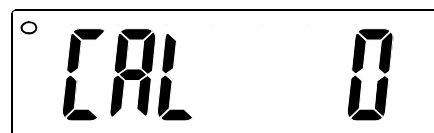
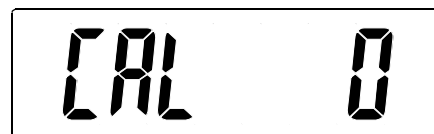
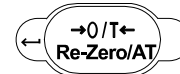
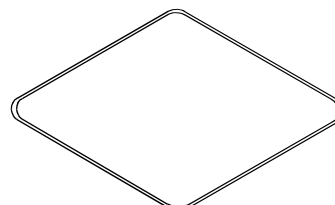

4. To calibrate with a weight different from the one displayed, press the **Reverse** key to change the value.
- “○” turns on when the value currently set is displayed

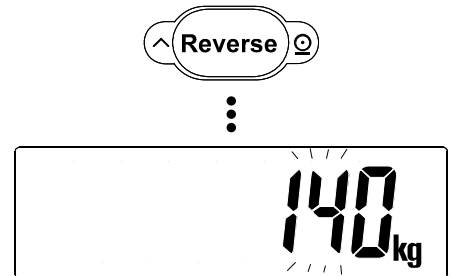
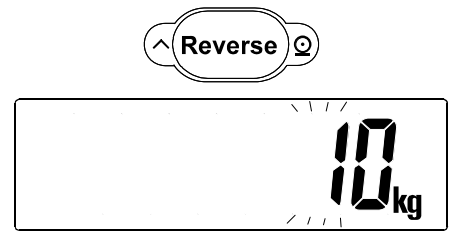

5. Place the calibration weight with the same value as displayed in the center of the weighing pan, and wait for the Stable indicator (○) to turn on.

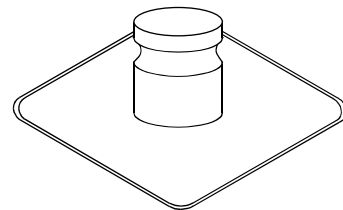

6. Confirm the Stable indicator (○) is turned on and press the **Re-Zero/AT** key. "End" is displayed to complete calibration. The scale goes to the weighing mode automatically.

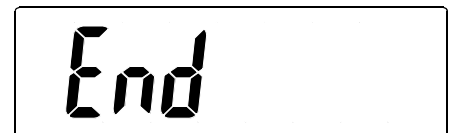
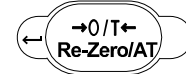



11.2. Gravity Acceleration Correction

When the scale is first used or has been moved to another location, it should be calibrated using a calibration weight. But if a calibration weight is not available, the gravity acceleration correction will compensate the scale. Change the gravity acceleration value stored in the scale to the value of the area where the scale will be used. Refer to the gravity acceleration map at the end of this manual.

1. While the scale is OFF, press and hold the **Reverse** and **Range** keys, and press the **ON/OFF** key to turn the scale ON. "CAL" is displayed.

While the scale is OFF,
press and hold

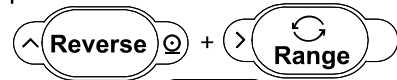

and press **ON/OFF**

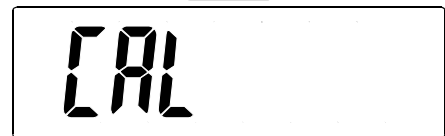

2. Press the **Range** key to display the gravity acceleration value currently set.
e.g.: $9.7985\text{m/s}^2 = "97985"$
(The decimal point is not displayed.)



3. Press the **Re-Zero/AT** key to enter the gravity acceleration value correction mode. A digit blinks. Change the value using the following keys.

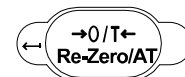

Range key: Shifts the blinking digit to the right.

Reverse key: Increases the value of the blinking digit by one.

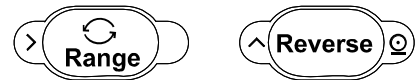

- "0" turns on when the value currently set is displayed

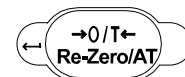

4. Press the **Re-Zero/AT** key to confirm the value. "End" is displayed to complete the gravity acceleration value correction.

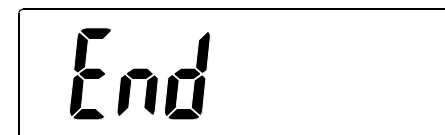



11.3. Restoring the Calibration Data to the Default settings

If the gravity acceleration value or calibration data is changed unintentionally, restore those values to the default values that are set at the factory.

1. While the scale is OFF, press and hold the **Reverse** and **RRange** keys, and press the **ON/OFF** key to turn the scale ON. "CAL" is displayed.

While the scale is OFF, press and hold

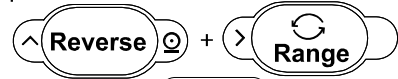

and press **ON/OFF**

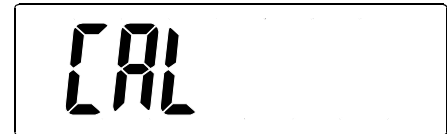

2. Press the **Range** key twice to display "Clr".

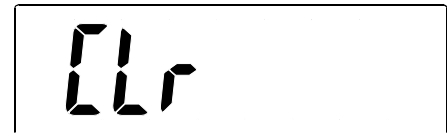

3. Press the **Re-Zero/AT** key. "no" is displayed blinking. Press the **Reverse** key to switch between "no" and "Go".

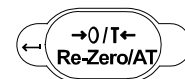
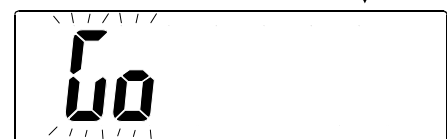
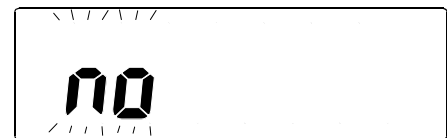
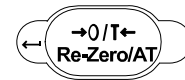

4. To restore to the default settings: While "Go" is displayed, press the **Re-Zero/AT** key.

5. "End" is displayed to complete the default settings restoration procedure.

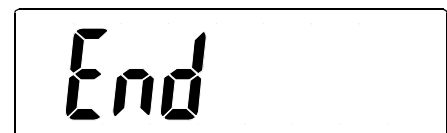



12. SA-03: RS-232C SERIAL INTERFACE

The SA-03 allows the SA series scale to be connected to a printer or a personal computer with the RS-232C interface.

- The RS-232C serial interface has the following four modes.
 - Stream mode..... Outputs data continuously.
 - Key mode..... Outputs data by pressing the Reverse key.
 - Auto-print mode Outputs data which meets the conditions of auto-print.
 - Command mode Controls the scale using commands from a computer.
- Set the parameters of the data format ($bP5$ and $bLPr$) and the data output mode (PrL), as necessary.
- Use a D-Sub 9 pin cable (straight type) to connect to a computer.
Optional cable: AX-KO2466-200 D-Sub 9 pin / 9 pin cable (2 m long)

SA-03 Installation

1. Turn the scale OFF.
Disconnect the AC adapter or remove the batteries.
2. Remove the screws on the underside of the scale to remove the option slot cover.
3. Insert the SA-03 connector into the connector in the option slot.
4. Secure the SA-03 using the screws removed in step 2.

Note: Be careful not to pinch the cables when securing the SA-03.

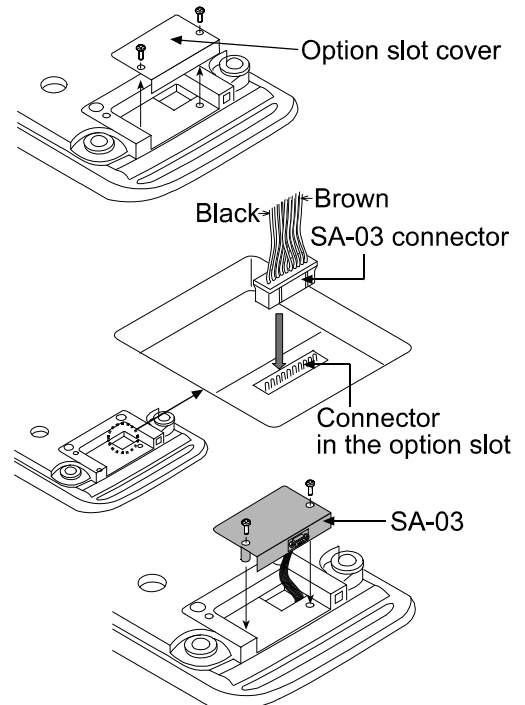

Interface Specifications

Transmission system	EIA RS-232C
Transmission form	Asynchronous, bi-directional, half-duplex
Data format	Baud rate: 2400, 4800, 9600 bps
	Data: 7 bits + parity 1bit (even or odd) or 8 bits (non-parity)
	Start bit: 1 bit
	Stop bit: 1 bit
	Code: ASCII
	Terminator: C_{RLF} (C_R : 0Dh, L_F : 0Ah)

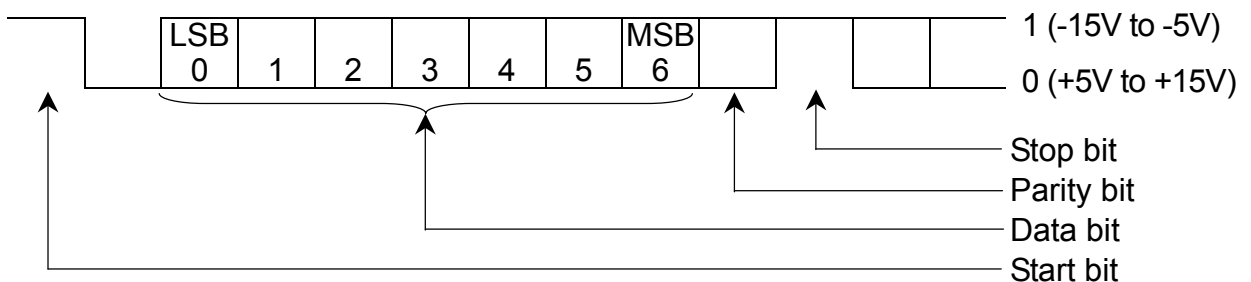

Pin Connections

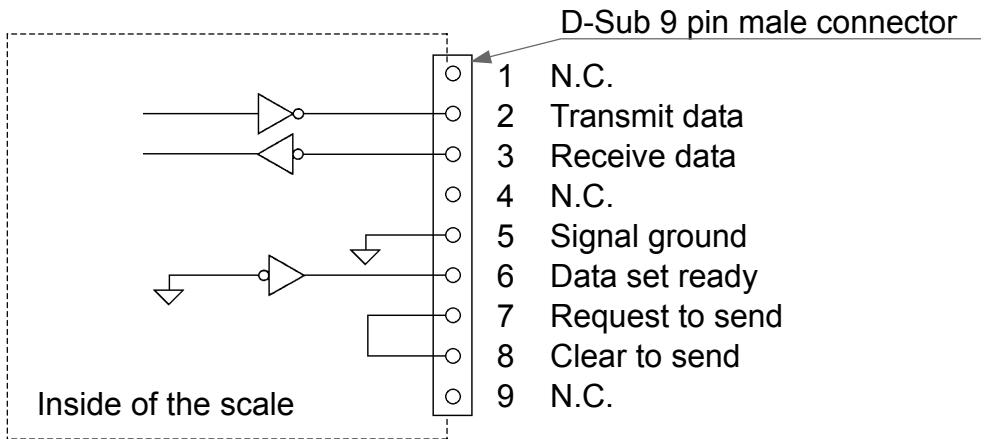

The interface is designated as DCE (Data Communication Equipment).

Data Format

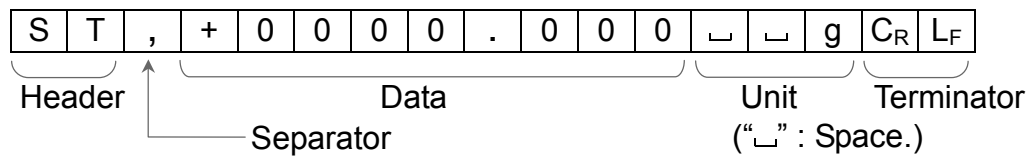

- There are three types of headers.
 - ST : Stable weighing data
 - US : Unstable weighing data
 - OL : Out of weighing range (Over)
- The data is normally 9 digits including a decimal point and a sign
- There are two types of units.
 - ␣g: Weighing data "gram"
 - ␣kg: Weighing data "kilogram"
- The terminator is always C_RL_F.
- Output data example

Weighing data "gram" S T , + 0 0 0 0 1 2 3 4 ␣ ␣ g C_R L_F

Weighing data "kilogram" S T , + 0 0 0 1 2 3 . 4 ␣ k g C_R L_F

Weighing data "kilogram" (+) O L , + 9 9 9 9 9 . 9 9 ␣ k g C_R L_F

Data Output Mode

Stream mode

Set the function to “Prt 0”.

The scale outputs the data currently displayed. The data update rate is approximately 10 times per second. This rate is the same as the display update.

The scale does not output data while it is in the setting mode.

Key mode

Set the function to “Prt 1”.

When the Reverse key is pressed while the weight value is stable (the Stable indicator is on), the scale transmits the data. When the data is transmitted, the display will blink one time.

Auto-print mode A

Set the function to “Prt 2”.

The scale transmits the weight value when it is stable (the Stable indicator is on) and is greater than +4d.

The next output will be performed after the value returns below +4d.

Auto-print mode B

Set the function to “Prt 3”.

The scale transmits the weight value when it is stable (the Stable indicator is on) and is greater than +4d or less than -4d.

The next output will be performed after the value returns between -4d and +4d.

Command Mode

In the command mode, the scale is controlled by commands that come from the personal computer.

Command list

- Command to request the current weighing data.

Command

Q	C _R	L _F
---	----------------	----------------

Reply

S	T	,	+	0	0	0	1	2	3	.	4	└	k	g	C _R	L _F
---	---	---	---	---	---	---	---	---	---	---	---	---	---	---	----------------	----------------

- Command to zero or tare the scale (same as the

Re-Zero/AT

 key).

Command

Z	C _R	L _F
---	----------------	----------------

Reply

Z	C _R	L _F
---	----------------	----------------

- Command to change the minimum display (same as the

Range

 key).

Command

U	C _R	L _F
---	----------------	----------------

Reply

U	C _R	L _F
---	----------------	----------------

Reply to the command

- When the command cannot be executed, for example, because the scale is unstable, the scale will send "I".

Reply

I	C _R	L _F
---	----------------	----------------

- If the received command is not for the SA series scale, the scale will send "?".

Reply

?	C _R	L _F
---	----------------	----------------

- When "RCL 0" is selected, there is no reply except the "Q" command.



13. MAINTENANCE



13.1. Storing and Cleaning the Scale

- Do not disassemble the scale.
- Do not use organic solvents to clean the scale. Use a lint free cloth moistened with warm water and a mild detergent.
- Check the scale periodically if it weighs accurately and calibrate the scale as necessary.
- Remove the batteries if the scale is not to be used for a long time.
- Use the original packaging for transportation.
- Be careful not to drop the scale or knock it over. It may cause scale failure.



13.2. Error Codes

Overload error



An object beyond the weighing capacity has been placed on the pan.
Remove the object from the pan.

Low battery error



The batteries are exhausted.
Stop using the scale immediately and replace all four batteries with new ones.

Other errors

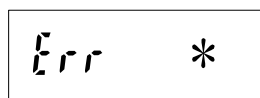

The scale has detected an error in the internal processing.
(* indicates the number.)

If you cannot resolve an error or other errors occur, request service from the store where you purchased the scale or from your local A&D dealer.



14. SPECIFICATIONS



14.1. Specifications

Model		SA-30K	SA-60K	SA-150K
Weighing capacity		30 kg	60 kg	150 kg
Minimum display(d)	R1	0.1 kg	0.1 kg	0.1 kg
	R2	0.01 kg	0.01 kg	0.01 kg
	R3	0.001 kg (0 ~ 3 kg)	0.001 kg (0 ~ 3 kg)	0.001 kg (0 ~ 3 kg)
		0.01 kg (3 ~ 30 kg)	0.01 kg (3 ~ 60 kg)	0.01 kg (3 ~ 150 kg)
R4	1 g (0 ~ 3000 g)	1 g (0 ~ 3000 g)	1 g (0 ~ 3000 g)	
	0.01 kg (3 ~ 30 kg)	0.01 kg (3 ~ 60 kg)	0.01 kg (3 ~ 150 kg)	
Repeatability (Std. Deviation)	R1	0.1 kg	0.1 kg	0.1 kg
	R2	0.01 kg	0.01 kg	0.01 kg
	R3	0.002 kg (0 ~ 3 kg)	0.002 kg (0 ~ 3 kg)	0.002 kg (0 ~ 3 kg)
		0.01 kg (3 ~ 30 kg)	0.01 kg (3 ~ 60 kg)	0.01 kg (3 ~ 150 kg)
R4	2 g (0 ~ 3000 g)	2 g (0 ~ 3000 g)	2 g (0 ~ 3000 g)	
	0.01 kg (3 ~ 30 kg)	0.01 kg (3 ~ 60 kg)	0.01 kg (3 ~ 150 kg)	
Linearity	R1	±0.1 kg	±0.1 kg	±0.1 kg
	R2	±0.01 kg	±0.02 kg	±0.05 kg
	R3	±0.002 kg (0 ~ 3 kg)	±0.002 kg (0 ~ 3 kg)	±0.002 kg (0 ~ 3 kg)
		±0.01 kg (3 ~ 30 kg)	±0.02 kg (3 ~ 60 kg)	±0.05 kg (3 ~ 150 kg)
R4	±2 g (0 ~ 3000 g)	±2 g (0 ~ 3000 g)	±2 g (0 ~ 3000 g)	
	±0.01 kg (3 ~ 30 kg)	±0.02 kg (3 ~ 60 kg)	±0.05 kg (3 ~ 150 kg)	
Display	7-segment LCD (Character height: 24 mm), 180° display rotation			
Display update	Approx. 10 times/s			
Operating temperature and humidity range	-10°C to 40°C, 85%R.H or less (non-condensing)			
Power source	AC adapter or four D (R20 / LR20) batteries			
Battery life	Approx. 700 hours (When Alkaline batteries are used at 23°C with backlight off) The battery life varies with manufacturers, conditions of use and storage.			
Weighing pan size	330 mm x 330 mm			
Mass	Approx. 6.3 kg			
Calibration weight (default setting)	30 kg	60 kg	150 kg	



14.2. External Dimensions

●SA-30K/SA-60K/SA-150K

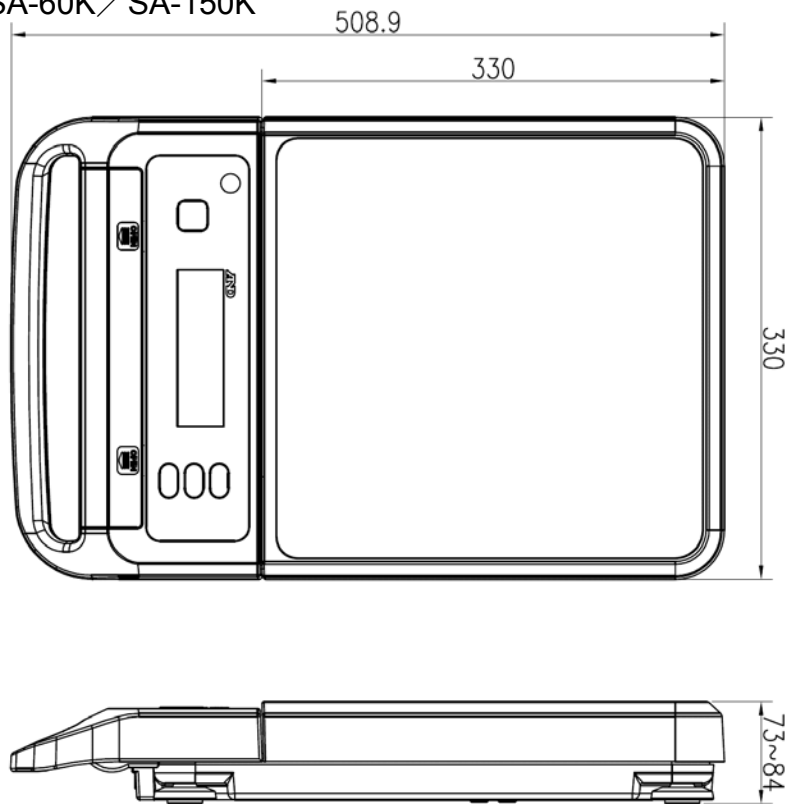

Unit: mm



14.3. Gravity Acceleration Map

Values of Gravity at Various Locations

Amsterdam	9.813 m/s ²	Manila	9.784 m/s ²
Athens	9.807 m/s ²	Melbourne	9.800 m/s ²
Auckland NZ	9.799 m/s ²	Mexico City	9.779 m/s ²
Bangkok	9.783 m/s ²	Milan	9.806 m/s ²
Birmingham	9.813 m/s ²	New York	9.802 m/s ²
Brussels	9.811 m/s ²	Oslo	9.819 m/s ²
Buenos Aires	9.797 m/s ²	Ottawa	9.806 m/s ²
Calcutta	9.788 m/s ²	Paris	9.809 m/s ²
Cape Town	9.796 m/s ²	Rio de Janeiro	9.788 m/s ²
Chicago	9.803 m/s ²	Rome	9.803 m/s ²
Copenhagen	9.815 m/s ²	San Francisco	9.800 m/s ²
Cyprus	9.797 m/s ²	Singapore	9.781 m/s ²
Djakarta	9.781 m/s ²	Stockholm	9.818 m/s ²
Frankfurt	9.810 m/s ²	Sydney	9.797 m/s ²
Glasgow	9.816 m/s ²	Taichung	9.789 m/s ²
Havana	9.788 m/s ²	Tainan	9.788 m/s ²
Helsinki	9.819 m/s ²	Taipei	9.790 m/s ²
Kuwait	9.793 m/s ²	Tokyo	9.798 m/s ²
Lisbon	9.801 m/s ²	Vancouver, BC	9.809 m/s ²
London (Greenwich)	9.812 m/s ²	Washington DC	9.801 m/s ²
Los Angeles	9.796 m/s ²	Wellington NZ	9.803 m/s ²
Madrid	9.800 m/s ²	Zurich	9.807 m/s ²

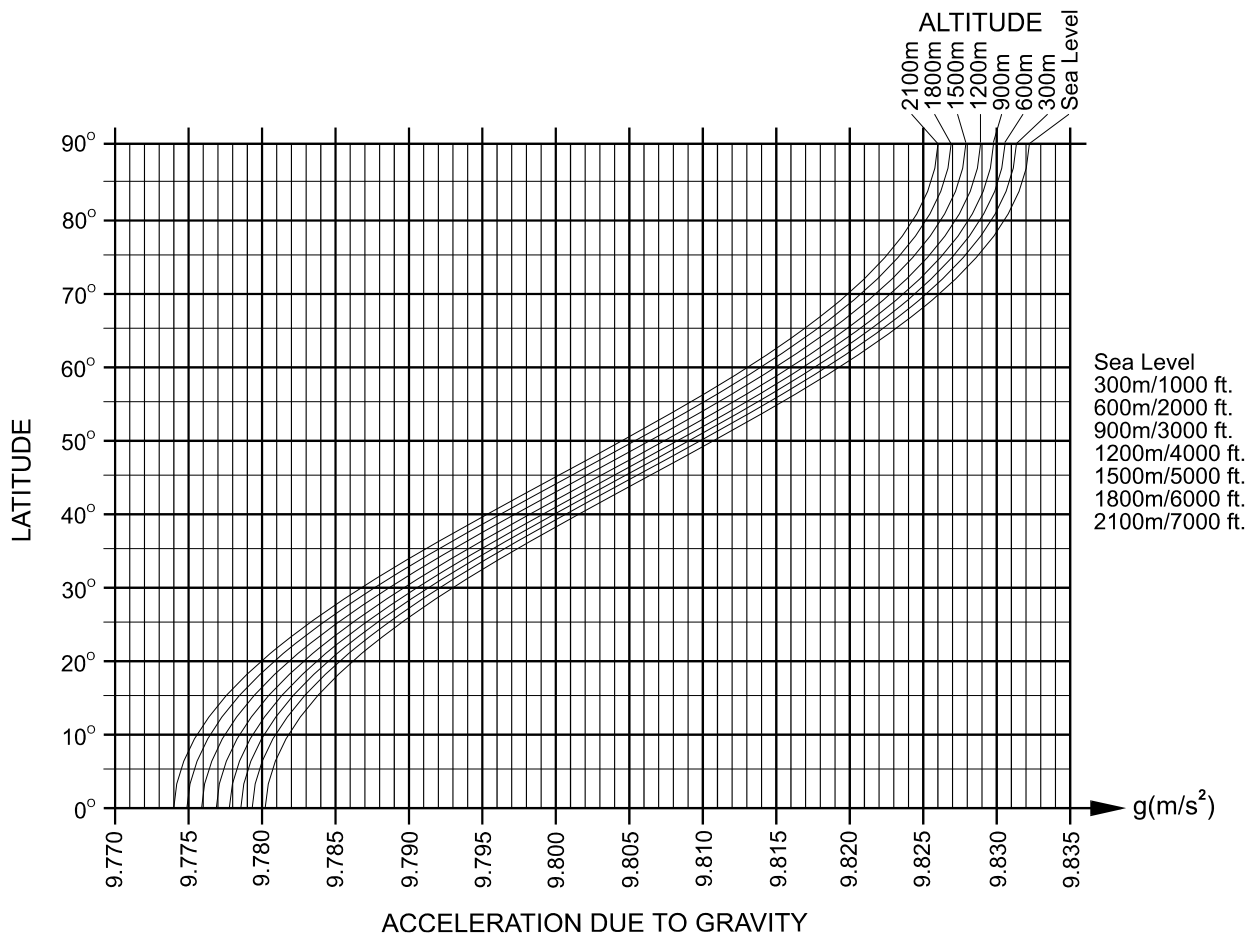

World Map

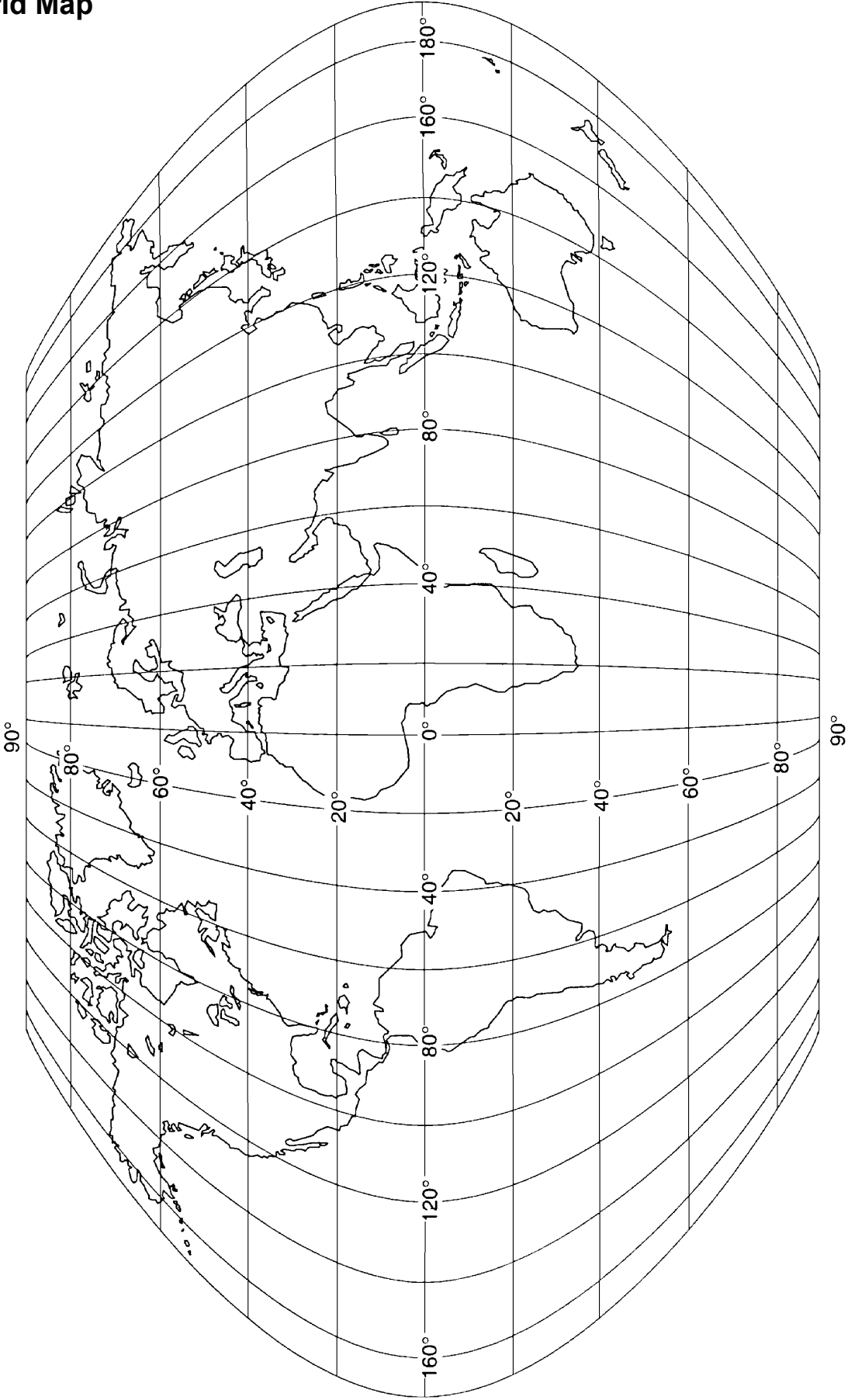



A&D Company, Limited

3-23-14 Higashi-Ikebukuro, Toshima-ku, Tokyo 170-0013, JAPAN

Telephone: [81] (3) 5391-6132 Fax: [81] (3) 5391-6148

A&D ENGINEERING, INC.

1756 Automation Parkway, San Jose, California 95131, U.S.A.

Telephone: [1] (408) 263-5333 Fax: [1] (408)263-0119

A&D INSTRUMENTS LIMITED

Unit 24/26 Blacklands Way, Abingdon Business Park, Abingdon, Oxfordshire OX14 1DY United Kingdom

Telephone: [44] (1235) 550420 Fax: [44] (1235) 550485

A&D AUSTRALASIA PTY LTD

32 Dew Street, Thebarton, South Australia 5031, AUSTRALIA

Telephone: [61] (8) 8301-8100 Fax: [61] (8) 8352-7409

A&D KOREA Limited 한국에이.엔.디(주)

대한민국 서울시 영등포구 여의도동 36-2 맨하탄 빌딩 8층 우편 번호 150-749

(Manhattan Building 8th Floor, 36-2 Yoido-dong, Youngdeungpo-gu, Seoul, 150-749 Korea)

전화: [82] (2) 780-4101 팩스: [82] (2) 782-4280

OOO A&D RUS ООО "Эй энд Ди Рус"

121357, Российская Федерация, г.Москва, ул. Верейская, дом 17

(Business-Center "Vereyskaya Plaza-2" 121357, Russian Federation, Moscow, Vereyskaya Street 17)

тел.: [7] (495) 937-33-44 факс: [7] (495) 937-55-66

A&D INSTRUMENTS INDIA PRIVATE LIMITED ऐंडी इन्स्ट्रूमेंट्स इण्डिया प्रा० लिमिटेड

509, उद्योग विहार, फेस -5, गुडगांव - 122016, हरियाणा, भारत

(509, Udyog Vihar, Phase-V, Gurgaon - 122 016, Haryana, India)

फोन : 91-124-4715555 फैक्स : 91-124-4715599