

HF SERIES

INSTRUCTION MANUAL

Multi-Function BALANCE

HF-200	HF-3200
HF-300	HF-4000
HF-320	HF-6100
HF-400	HF-6000
HF-2000	HF-8000
HF-3000	



This is information mark that inform to you about the operation of balance.



This is notice mark that inform to you on the operation of balance.



This is hazard mark.



Contents

Introduction	3
Features	3
Options and Accessories	3
Compliance with FCC Rules	3
Unpacking your Balance	4
Breeze Break Assembly (HF-200, HF-300, HF-320, HF-400)	5
Balance Location	6
Best conditions for weighing	6
Setting up your Balance	7
Taking care of the Balance	7
Power Supply	8
Display ON:OFF & Power Errors	8
Keys and Displays	9
Displays	9
Keys	9
Units	10
Weighing Units and their Conversions	10
Selecting the Weighing Unit	11
Weighing	12
Simple Weighing	12
Counting Mode (pcs)	13
ACAI Automatic Counting Accuracy Improvement	14
ACAI Notes	15
Counting Mode using Digital Input of Unit Weight	16
Percent Mode (%)	17
Percent Mode (%) with Digital Input of 100% Weight	18
Measuring differences in Percent (%) Mode	19
Animal Mode	20
Animal Weighing - Example of use	21
Environment Response Adjustment	22
Conditions of response	22
Calibration	23
Displays and cancelling calibration	23
Calibration Procedure	24
Zero-point-calibration	25
Functions	27

C-parameter keys and displays -----	27
Internal parameter setting -----	28
C-parameter settings -----	29
The ID number and GLP -----	31
Setting the ID number -----	31
Miscellaneous -----	33
Digital Tare -----	33
External Key Connector -----	34
Underhook Weighing -----	35
An Example of Underhook Weighing -----	35
Errors and Specifications -----	36
Errors -----	36
Specifications -----	38
Dimensions -----	39
Index -----	40



Introduction

*Thank You For Your **AD** Purchase*

Electronic Balances are easy to use, yet they are rather complex in that they are high technology products. This manual will tell you in simple language how this balance works and how to get the most out of it in terms of performance.



Features

- The HF series can be easily adapted to most operating environments through simple adjustments from the keyboard.
- The OP-03 serial interface, allows control of the balance or transmission of the weighing data to a computer or printer.
- Ten hour operation is possible using the optional battery pack, OP-09.
- Good Laboratory Practices (GLP) calibration output using the OP-03 / 05 serial interface.
- A calibration mass correction function allows precise input of the calibration mass.
- Multiple weighing units, with most of the common units used around the world.
- Counting (pcs) mode, for inventorying lightweight components or pharmaceuticals.
- Percent (%) mode, for matching weights against a standard.
- Animal Weighing Mode, for weighing small animals.
- Digital Tare, allows the input of a tare value from the keyboard or via the RS-232C interface.
- Security, the serial number of the balance is available using the RS-232C interface.



Options and Accessories

- OP-03 Serial interface, Bi-directional RS-232C/ Current Loop.
- OP-05 Current Loop printer interface.
- OP-09 Ni-MH battery pack.
- OP-10 Glass weighing chamber (except HF-6000 & HF-8000).
- OP-11 Animal weighing pan (HF-2000, HF-3000, HF-3200, HF-4000, HF-6100).
- AD-8121 multi-function printer. This printer can print weighing data, total weighing counting and standard deviation, along with the time and date. Includes statistical calculation.



Compliance with FCC Rules

Please note that this equipment generates, uses and can radiate radio frequency energy. This equipment has been tested and has been found to comply with the limits of a Class A computing device pursuant to Subpart J of Part 15 of FCC rules. These rules are designed to provide reasonable protection against interference when equipment is operated in a commercial environment. If this unit is operated in a residential area it might cause some interference and under these circumstances the user would be required to take, at his own expense, whatever measures are necessary to eliminate the interference. (FCC = Federal Communications Commission in the U.S.A.)



Unpacking Your Balance

- ❑ Unpack the balance carefully and keep the packing material if you want to transport the balance again in the future.
- ❑ In the carton you should find this manual plus:

Breeze break
standard for:
HF-200
HF-300
HF-320
HF-400

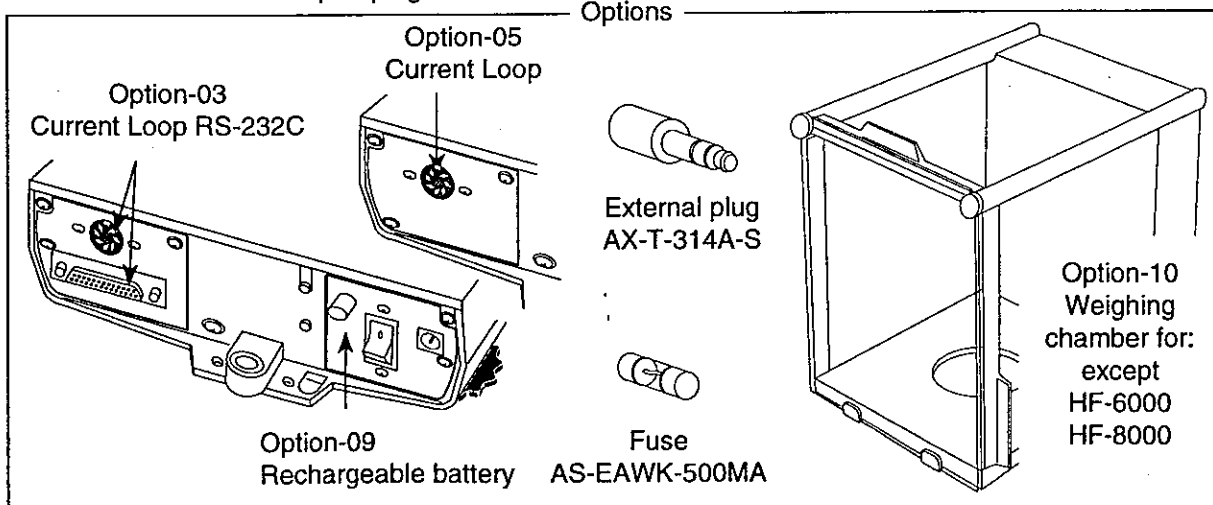
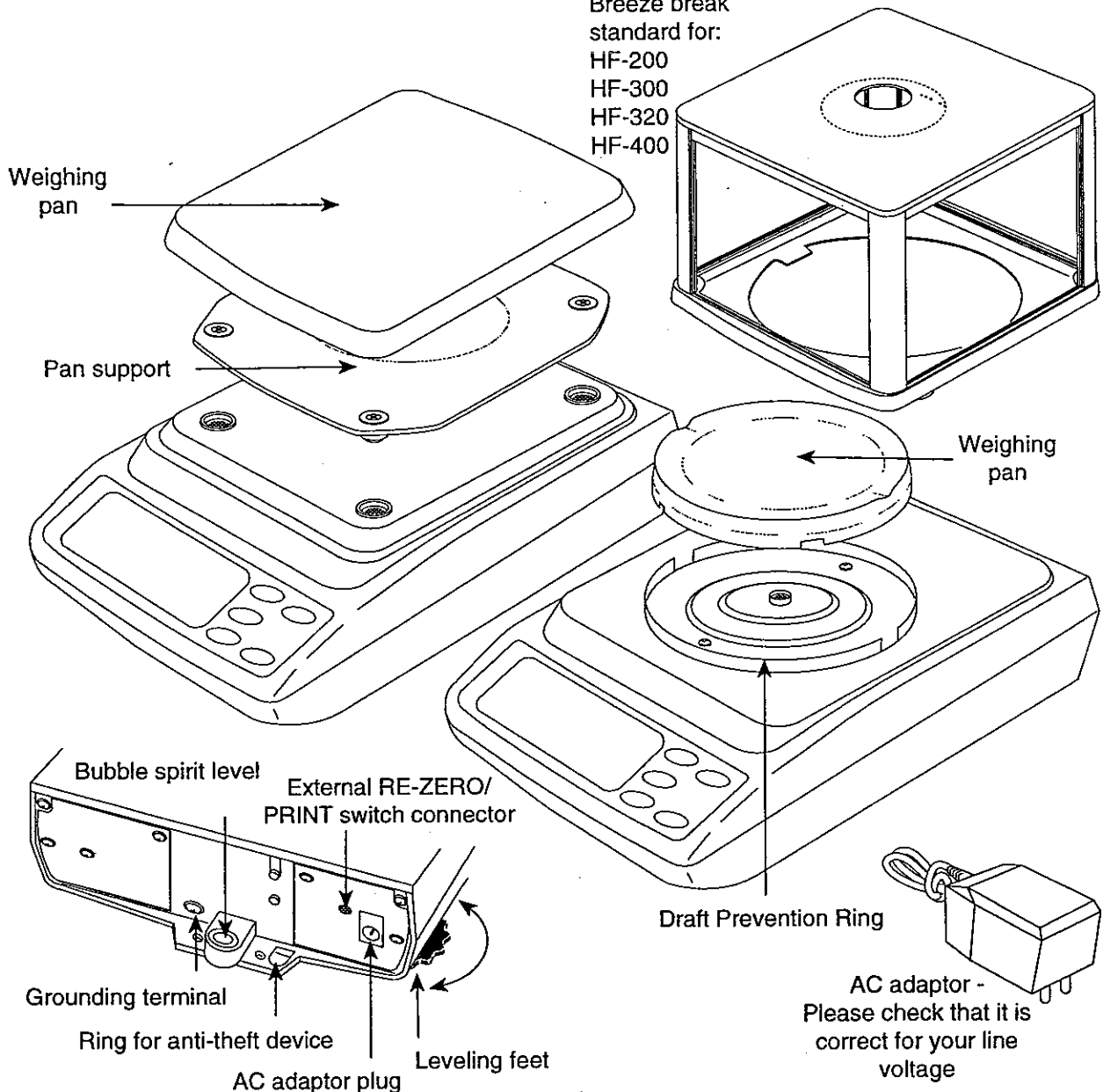

Breeze Break Assembly (HF-200, HF-300, HF-320, HF-400)

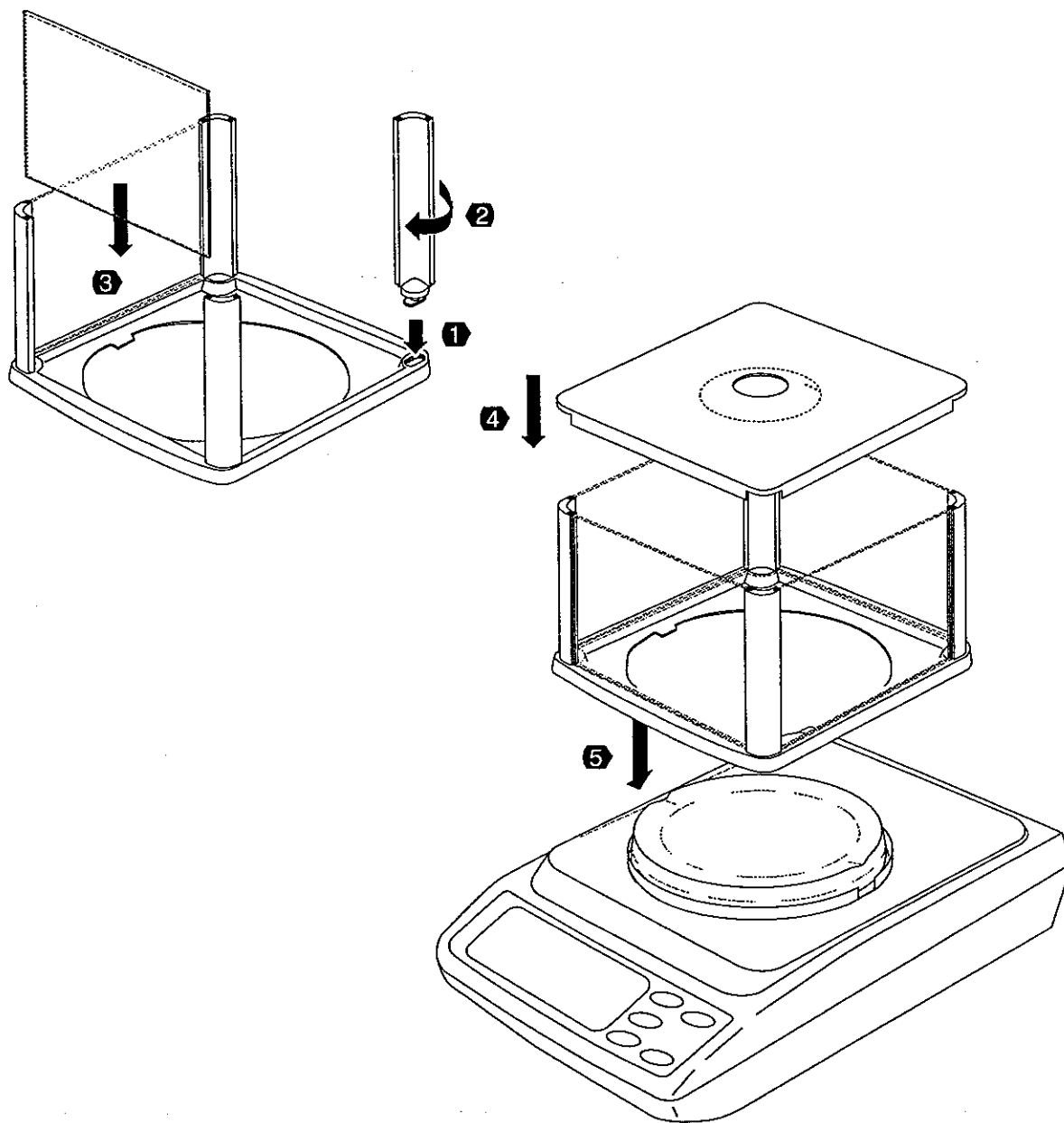

- 1** Fit the column posts into the slots at the four corners.
- 2** Turn the column posts to fasten them.
- 3** Insert the acrylic plates into the column groves.
- 4** Lower the Breeze Break top into position.
- 5** Position the Breeze Break base so that its stop tab fits into the draft ring slot..

Balance Location

- The weighing table should be solid and free from vibration, drafts (such as frequently opening doors or windows) and as level as possible.
- Corners of rooms are best as they are less prone to vibrations.
- Don't install the balance near heaters or air conditioners.
- Don't install the balance in direct sunlight.
- Don't use the balance near other equipment which produces magnetic fields.
- Try to ensure a stable power source when using the AC adaptor.
- The best operating temperature is about 20°C/68°F at about 50% Relative Humidity.

Best conditions for weighing



To ensure that you get the most from your balance, please try to follow these conditions as closely as possible:

- Please warm-up (plug-in) the balance for at least one hour.
- The weighing room should be kept clean and dry.
- Please RE-ZERO the balance before each use to prevent possible error.
- Make each weighing quickly to avoid errors due to changes in environmental conditions.
- Use a breeze break to keep out drafts.
- Do not drop things upon the weighing pan, or place a weight beyond the range of the balance on the weighing pan.
- Do not use a sharp instrument (such as a pencil or ball point pen) to press the keys, use only your finger.
- Use caution when weighing items that could have a static charge (plastics, insulator, etc.), as the weight of a material that has a static charge is influenced by its surroundings. Try to keep the ambient humidity above 45%RH.
- This balance uses a strong magnet as part of the balance assembly, so please use caution when measuring magnetic materials. If there is a problem, use the underhook assembly (on the bottom of the balance) to suspend the material away from the influence of the magnet.
- When weighing a sample that is either warmer or cooler than the ambient temperature, the sample can set up a draft due to the air rising or falling next to the sample. This draft can cause a shift in the weight of the sample.
- Due to the affect of air buoyancy on a sample, please take this into account when absolute accuracy is required.
- There are two methods of pressing a key. The first, is to press and release a key; and the second, is to press and hold a key. Each of these will perform a different function. Please refer to your instruction manual to learn the functions of the keys. Take special care with the **RE-ZERO** key, because if it is pressed and held, the balance will enter the calibration mode which could cause you to reset calibration improperly.

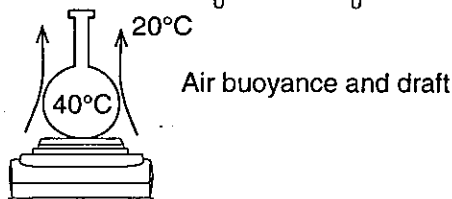
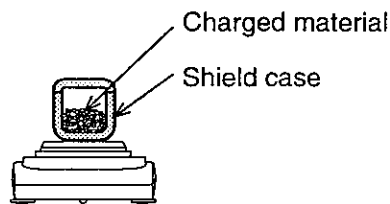

- Accessory for HF series includes "Clear cover".
Accessory for HF-400 / 300 / 320 / 200 includes "Breeze break".
These accessories may have static electricity when they are unpacked, when they are charged electricity by operation or environment. This static electricity influences weighing, appears phenomenon that are drift, linearity error and hysteresis error.
In this case, remove this clear cover or breeze break, or use an anti-static spray.

Setting up your Balance

- Place the balance on a firm weighing table and turn the adjustable feet until the balance is level (check the spirit level on the rear of balance).
- Install the weighing pan and breeze break (if used) on the balance (see the section on "Unpacking Your Balance").
- Plug in the AC adaptor. The adaptor's input requirements could be 100, 120, 220 or 240 Volts (50/60Hz) depending on where you are in the world, so please check that the adaptor is the correct voltage. Ground the balance chassis for electrostatic discharge if static electricity could be a problem.

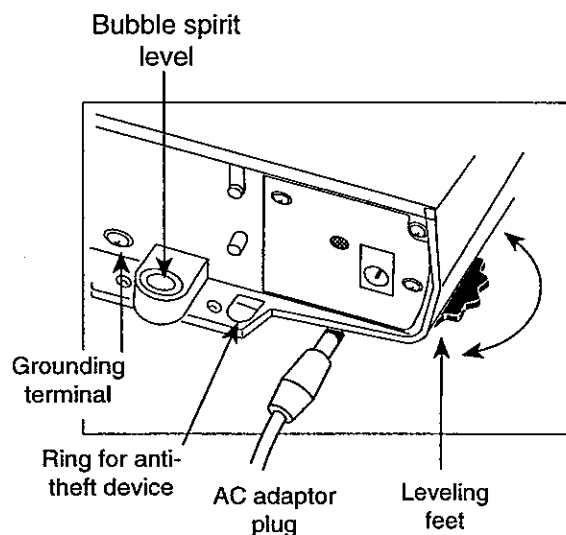

Taking care of the Balance

- Don't disassemble the balance. Contact your local A&D dealer if your balance needs service or repair.
- Don't use solvents to clean the balance. A lint free cloth is best for cleaning, using warm water with a mild detergent.
- Keep equipment containing magnets away from the balance.
- If you use the battery and "Lb" is displayed, charge the battery as soon as possible.
- To preserve battery life, do not recharge the battery until the "Lb" display is on.
- Protect the internal parts from liquid spills and excessive dust.
- Please use a very precise calibration mass.



Power Supply

When the AC adaptor is connected, the balance is in the standby mode if the standby indicator is on (see "Displays" on the next page). This is a normal state and does not harm the balance. We recommend that you plug in your balance for at least an hour before use so it can warm up.



Display ON:OFF & Power Errors

- The balance does a self check when you connect the AC adaptor or press the **ON:OFF** key. If there is a problem, you will get an error display. Please refer to the error code table. P-FAIL will be displayed if the power was cut with the display on. To clear this error, press the **ON:OFF** key.



Keys and Displays



This section explains the keys and displays for the weighing mode. Refer to the following separate sections for an explanation of Percent (%) Mode, Counting (pcs) Mode and Animal Weighing (g) Mode.



Displays

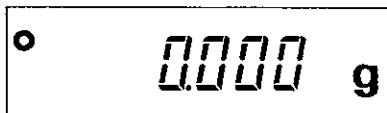

Normal weighing display of zero. Please read weighing data only after the stabilization mark is displayed.

Note: the number of decimal places depend on the model in use (HF-300 illustrated).

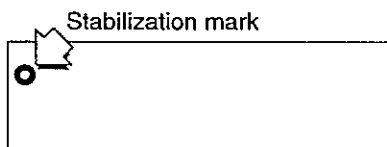

This round symbol is the stabilization mark. It is displayed when the balance is stable and the weighing data can be read. Refer to "Stability Band Width" Function.

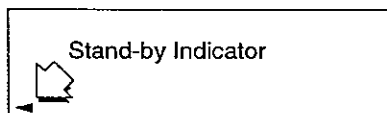

This is the Stand-by Indicator. This mark is displayed when you turn the display off, and the AC adaptor still connected.



Keys



The **ON/OFF** key switches the display ON and OFF but does not cut the power to the balance. The balance will remain on standby (warm up) while the AC adaptor remains connected.



The **RE-ZERO** key is used to zero the display within the range of the balance. This key returns the balance to the center of zero when the weighing pan is empty, and can also tare total weight (container and sample). Please use this key before each weighing to cancel possible error.



- The **SAMPLE** key can be used to register a sample count (eg: 10 units) in counting "pcs" mode or register 100% in percentage mode.
- The **SAMPLE** key can also be used to hide or show the minimum figure alternatively.

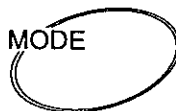

If you press the **MODE** key, the balance switches between weighing modes. However, only selected modes will be displayed.

If you press and hold the **MODE** key, the balance changes the adjustment mode to a new weighing environment. This mode sets the response of the balance. This parameter is common to the "Response / Environment" function and "Condition of response". Refer to this function and "Condition of response".



The **PRINT** key can be used to output data to a printer or personal computer if the RS-232C or current loop is installed. Please refer to section "Functions" for details of output format and setting up the balance.

Units

The most common unit of weight used around the world is grams, but there is often a need to shift to an alternative unit specific to the country where the balance is used or to select modes such as counting or percent.

The **MODE** key is used to switch between the weighing modes, counting and percent as follows:

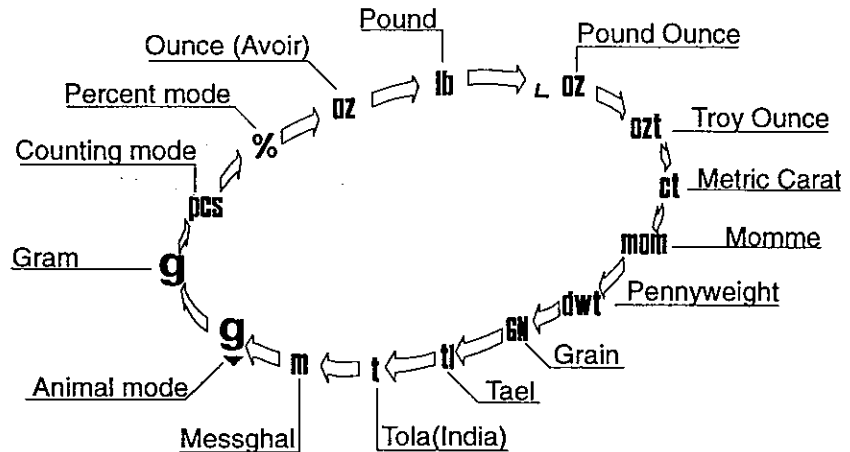

If a mode or unit of weight has been turned off, the sequence will be missing that mode or unit. There are also the various Tael and Tola that can be included if necessary.

Weighing Units and their Conversions

Abbrev.	Name	Conversion
oz	Ounce (Avoir)	28.3495231g
lb	Pound	453.592g
ozt	Troy Ounce	31.1034768g
ct	Metric Carat	0.2g
mom	Momme	3.75g
dwt	Pennyweight	1.55517384g
GN	Grain (UK)	0.06479891g
tl	Tael (HK general, Sing.)	37.7994g
tl	Tael (HK, jewelry)	37.429g
tl	Tael (Taiwan)	37.5g
tl	Tael (China)	31.25g
t	Tola (India)	11.6638038g
mes	Messghal	4.6875g



Selecting the Weighing Units



The HF series balances are multi-functional instruments where switching between the weighing units contained in the balance software is done by pressing the **MODE** key.

If the law in your area permits, you may use all of the units, or at this software level you can disable the weighing units you don't regularly use. Also, some dealers may initially turn OFF units which are not regularly used, but you may want to turn them back on. The complete weighing mode cycle is as follows (if some are missing please refer to your dealer):

- 1** Turn off the display
- 2** Press and hold the **MODE** and press the **ON:OFF** key. The balance will display the test mode and then "Unit".
- 3** Select the modes you want active using the following keys:

MODE key to step through the modes

SAMPLE key to select the mode

ON:OFF key to cancel the updating new set

- 4** Press the **PRINT** key to store the modes selected and return to normal display.

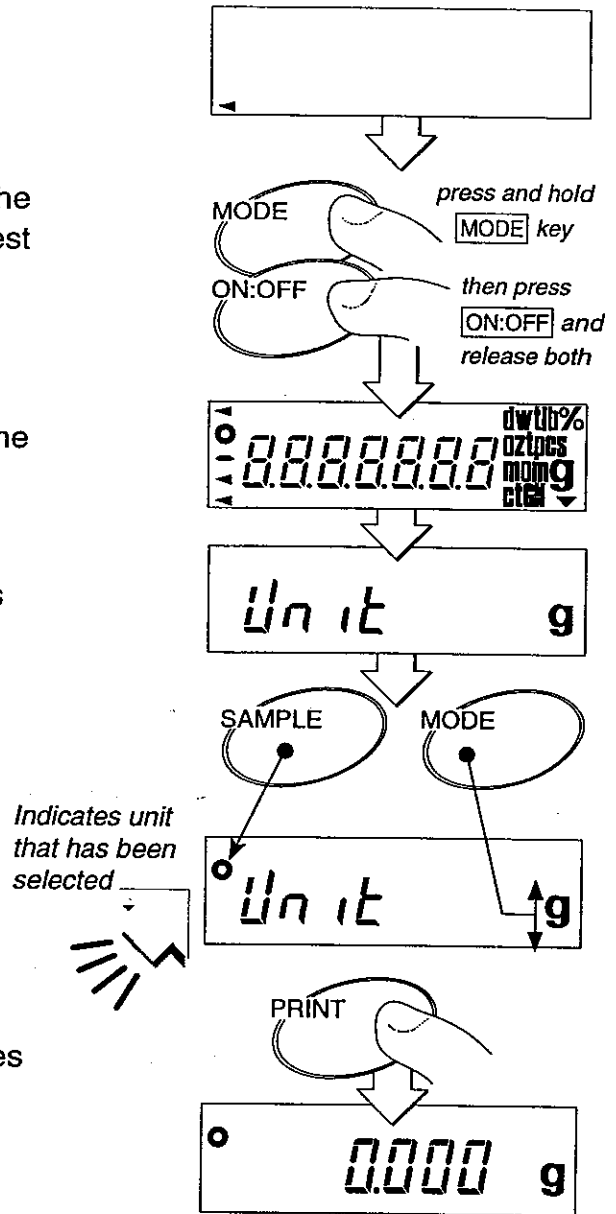



Weighing



For accurate weighing, please warm up the balance for an hour before use and try to meet "Best conditions for weighing".



Simple Weighing

- 1 Turn the display on using the **ON:OFF** key. After a moment "zero" will be displayed.

(The number of decimal places on the display depends on the model in use.)

- 2 If you are using a tare container, place it on the weighing pan. The display will show the container weight.

- 3 Press the **RE-ZERO** key to cancel the weight.

- 4 Place the object to be weighed in the container.

- 5 Wait for the stabilization mark to come on and read the weight.

- 6 Remove the object from the pan.

- 7 Turn the display off using the **ON:OFF** key. The display will show the stand-by indicator.

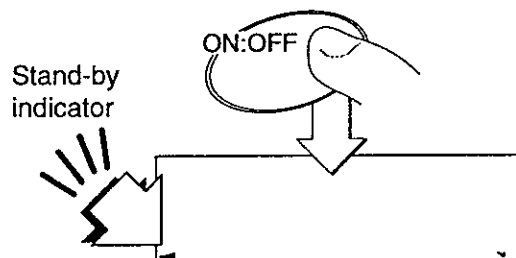
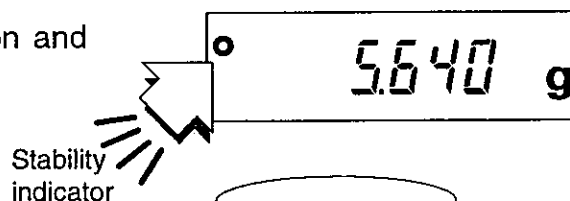
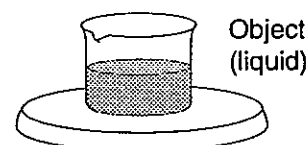
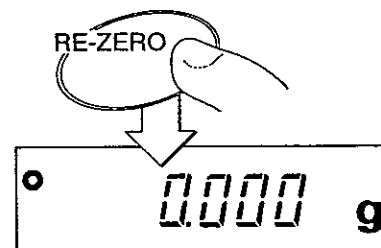
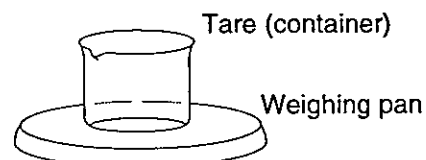
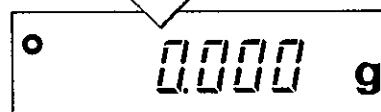
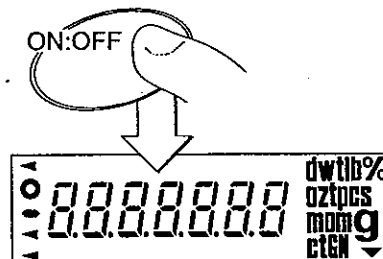

Counting Mode (pcs)

Often there is a need to be able to count small parts or pharmaceuticals. This is usually an inventory function that can be a problem due to the light weight of the individual item.

The HF balance counts by calculating the average weight of one piece-weight called the unit weight, then applying it to the total weight of what you are trying to count. A&D has added exclusive software called ACAI™ (Automatic Counting Accuracy Improvement) that constantly updates the unit weight. It is explained on page 14.

The unit-weight can be stored using all of the displayed figures. HF-320 and HF-3200 can store unit-weight in upper range values only.

This is the step by step process for using the counting function:

1 Select "pcs" using the **MODE** key (if you want to clear the current unit weight, press the **SAMPLE** key).

Press the **RE-ZERO** key to clear any offset from zero, such as a container to hold the items to be counted.

2 If you want change number of items table used for the sample quantity, press the **PRINT** key to select the number of items to be used for the sample. This may be set to 10, 20, 30, 40, 50, 60, 70, 80, 90 or 100. (The higher the number, the better the accuracy).

3 Place the sample to be counted on the pan (this will normally be the same quantity as the count displayed).

4 Wait for the stabilization mark to come on. Press the **SAMPLE** key. The balance will calculate the unit weight and store it (this value is saved, even if the balance is turned off).

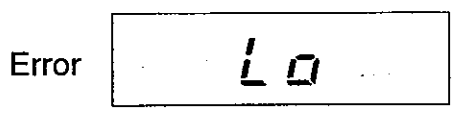

If the sample is very light, the balance may not be able to calculate the unit weight.

5 Add the remainder of the items to be counted.

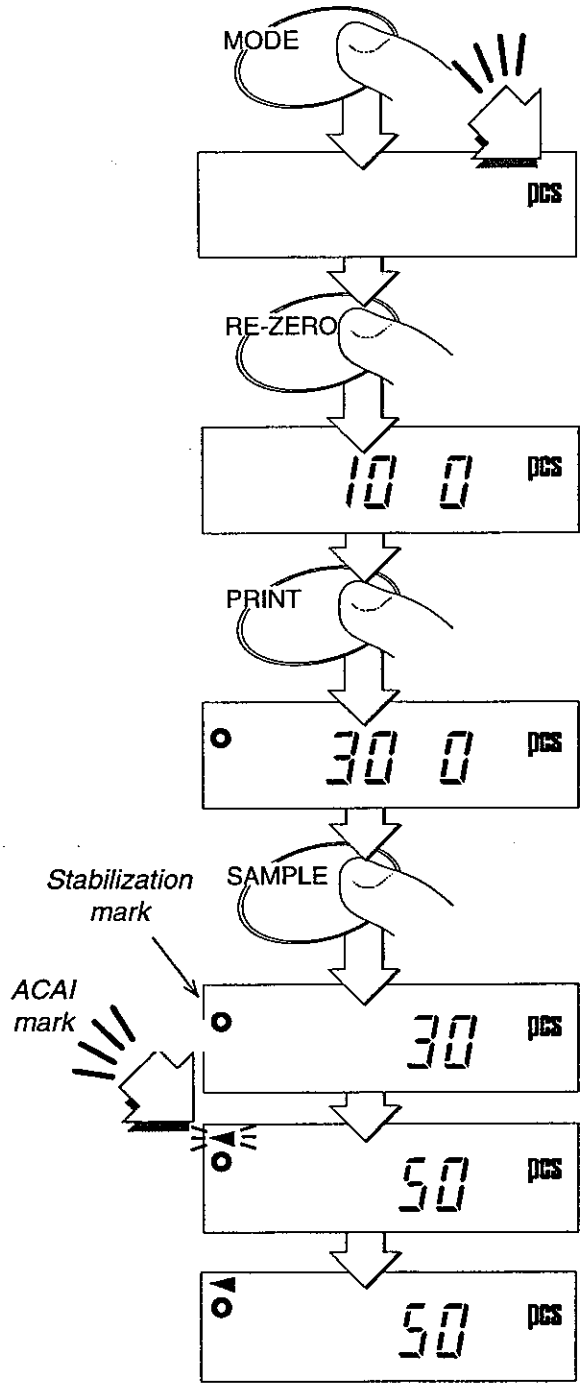

ACAI Automatic Counting Accuracy Improvement

The ACAI™ (Automatic Counting Accuracy Improvement) function re-calculates the unit weight as more items are added, to improve the accuracy.

The ACAI indicator



When the balance calculates the unit weight, the higher the number of items in the sample, the higher the accuracy.

Example: If you use 10 very small parts as your sample, with a unit weight of 0.1000 grams calculated by the balance. Using the ACAI feature, after 200 parts were counted, the updated unit weight was .0995 grams. This does not seem like a significant difference, but the count could have been off by 1 part at a count of 200, 2 parts at 400, etc..

$$0.1000 - 0.0995 = 0.0005\text{g}$$

$$0.0005\text{g} \times 200 \text{ parts} = 0.1000\text{g or } 1 \text{ part.}$$

This would not be acceptable if the part is expensive. This would be totally unacceptable to a purchaser if he stopped to count the parts.

To use ACAI, Follow the steps outlined on the previous pages, then follow these steps:

- 1** Add a small number of additional parts (it is not necessary to count the added number).
- 2** Allow the ACAI indicator to blink several times then stay on. Then, the ACAI indicator will turn off and the unit weight data is updated. Wait for the ACAI indicator to turn off, as this indicates that the balance has updated the unit weight.
- 3** Repeat steps 1. and 2., each time approximately doubling the amount added. Continue this process until you reach the desired count.
- 4** ACAI stores the corrected unit weight in memory until a new sample is established or the process is repeated.

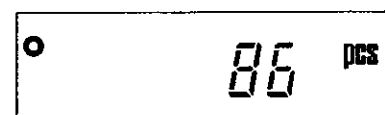
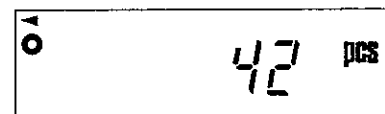
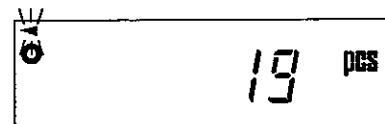
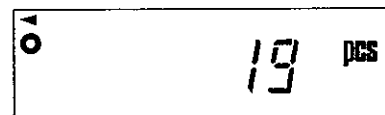

Please add these samples according to the table to best use the ACAI function.

Count on the weighing pan	Next total count on the weighing pan	Count on the weighing pan	Next total count on the weighing pan
10	13~26	70	73~118
20	23~47	80	83~128
30	33~65	90	93~138
40	43~81	100	103~148
50	53~95	101~	As necessary, but greater than the current count plus 3
60	63~108		



ACAI Notes

- You must use the ACAI procedure immediately after establishing the unit weight. Do not remove original samples, just continue to add.
- There is no need to actually count the additional items added.
- Do not remove the sample until the ACAI procedure is completed (if you remove the sample, the balance will accept this as the maximum amount that you want the ACAI to correct for).
- The balance will store the unit weight for the next count.
- If you use "Digital Unit of Weight" the balance can not use the "ACAI" mode for counting.

Measuring differences in Percent (%) Mode

- 1** Select "%" using the **MODE** key.
- 2** Press the **SAMPLE** key to switch to the sample input mode.
- 3** Press the **RE-ZERO** key to set the zero point.
- 4** Place the item to be used as the sample on the pan.
- 5** Press the **SAMPLE** key. The balance will store the weight of the sample as the 100% point.
- 6** Press the **RE-ZERO** key and remove 100% sample.
- 7** Load the next sample. The weighing difference is displayed in percentage (%).

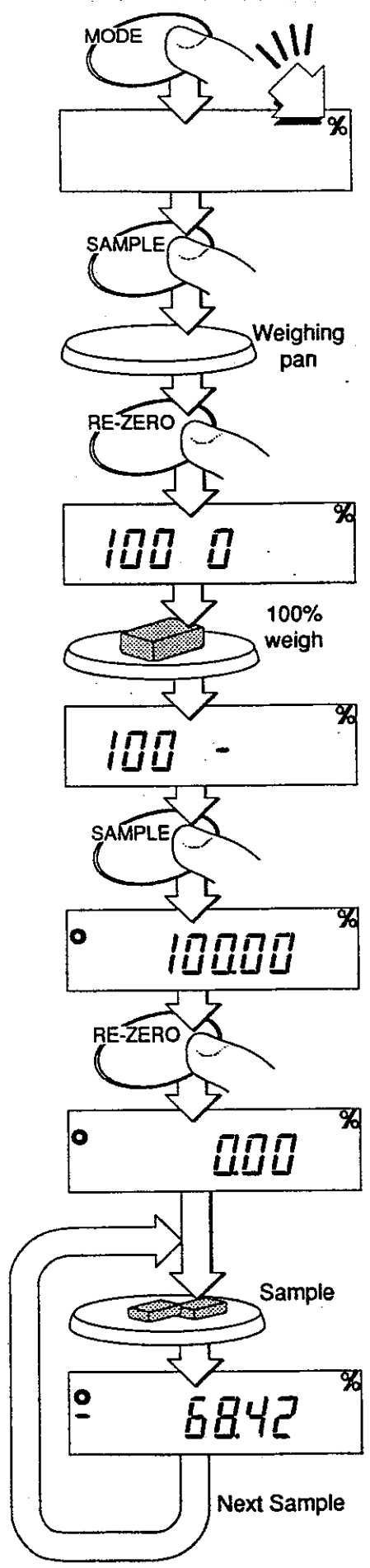

Percent Mode (%)



The HF balance has a Percentage mode that allows you to establish a 100% point, and then use this to determine a percentage based on that sample. Less or greater than 100% may be displayed at 1%, 0.1% or 0.01%, dependent on the range of digits used.

The minimum figure of 100% weight that is able to store a value is as follows:

The single range balances are: minimum digit x 100.

HF-320, HF-3200 are: minimum digit x 100 of the upper range.

- 1** Select "%" using the **MODE** key.
When the balance displays a value in the unit of percentage, press the **SAMPLE** key.
- 2** Press the **SAMPLE** key to switch to the sample input mode.
- 3** With nothing on the pan. Press the **RE-ZERO** key to set the zero point.
- 4** Place the item to be used as the sample on the pan.
- 5** Press the **SAMPLE** key. The balance will store the weight of the sample as the 100% point.
- 6** Remove the sample and place another item to be checked on the pan. Wait for the stability indicator to come on and read the percentage.

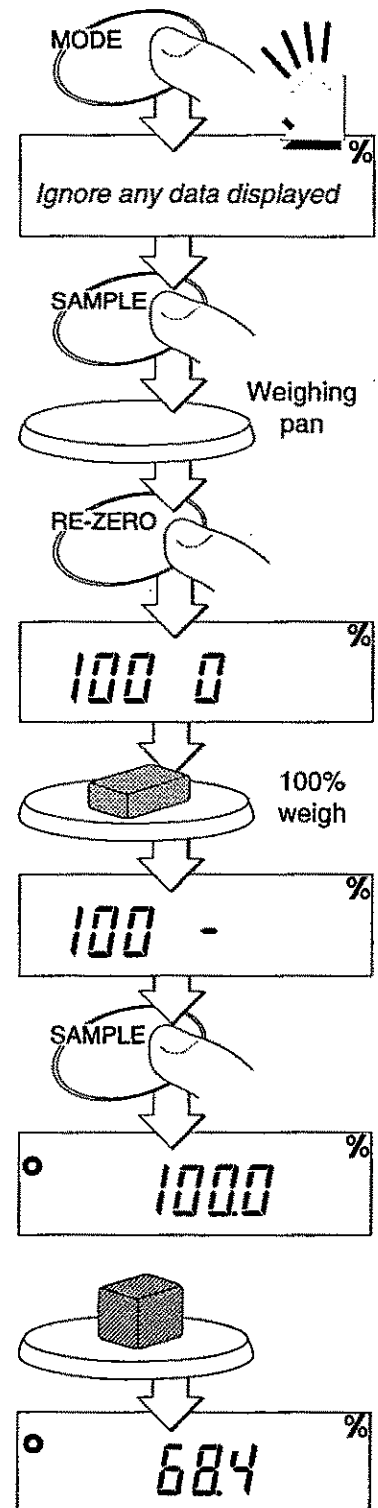

Percent Mode (%) with Digital Input of 100% Weight



The HF balance has a Percentage mode that allows you to enter the 100% weight using the keyboard or a computer (using the optional RS-232C interface) for the percentage sample.

- 1** Select "%" using the **MODE** key. When the balance displays a value in the unit of percentage, press the **SAMPLE** key.
- 2** Press and hold the **SAMPLE** key to switch to the sample input mode. "PU" will be displayed. If you would like to use a different weighing unit other than the one shown, Press the **MODE** key to select the unit of weight.
- 3** Press the **RE-ZERO** key to store the unit weight in memory. If no unit weight is stored in memory the display will be ".".
- 4** Press the **MODE** key to enter the value setting mode.
- 5** Press the **MODE** key to select the digit to change and the **RE-ZERO** key to set the value of the digit selected.
- 6** Press the **PRINT** key to store this value.

"PE" will be display for a few seconds, then the percentage will again be displayed.

The sample weight for the 100% point is stored in memory and will be retained if the power is turned off.

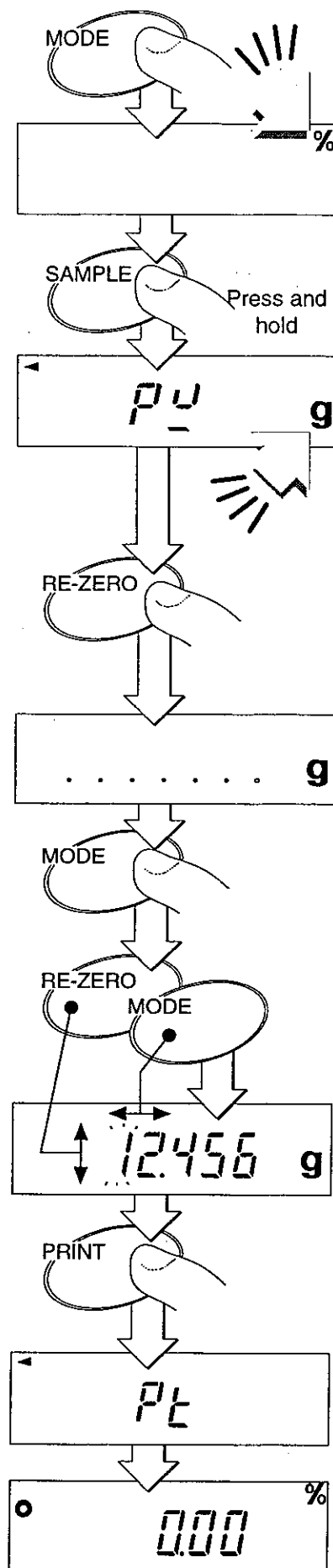

Measuring differences in Percent (%) Mode

- 1** Select "%" using the **MODE** key. When the balance displays a value in the unit of percentage, press the **SAMPLE** key.
- 2** Press the **SAMPLE** key to switch to the sample input mode.
- 3** Press the **RE-ZERO** key to set the zero point.
- 4** Place the item to be used as the sample on the pan.
- 5** Press the **SAMPLE** key. The balance will store the weight of the sample as the 100% point.
- 6** Press the **RE-ZERO** key and remove 100% sample.
- 7** Load the next sample. The weighing difference is displayed in percentage (%).

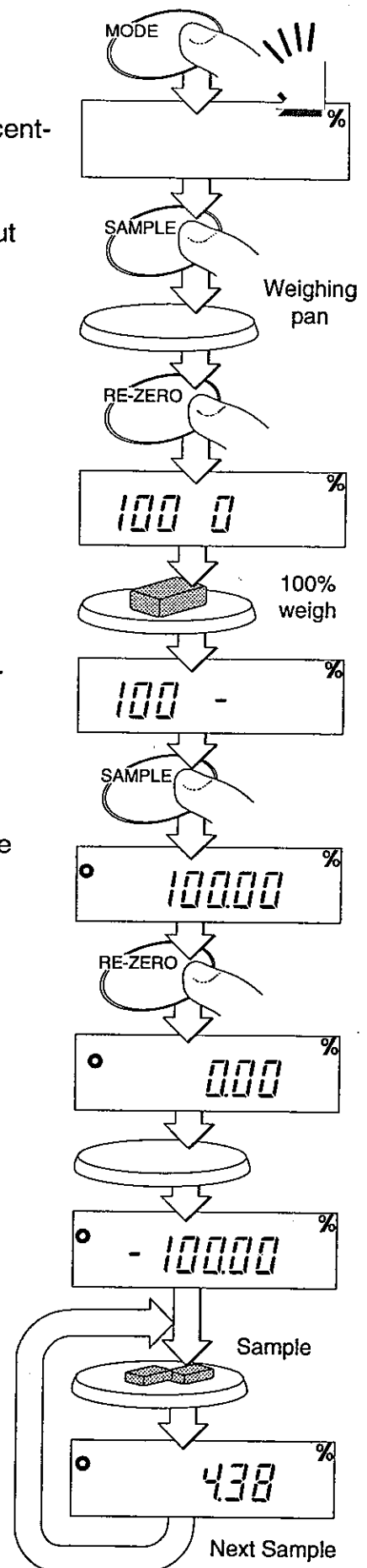



Animal Mode



Use animal mode to weigh small living animals. The balance is allowed to stabilize for a fixed period of time, then the 'Animal mode' mark comes on and the average sample weight of the moving object is displayed.



This mode can only be used after setting the display to zero. Press the **RE-ZERO** key to set the display to zero.

○ Animal Mode Conditions:

After setting the display to zero, animal mode is only activated if the display changes by at least the amounts shown in the following table. If the weight is less than the amount given below, the balance will remain in the normal weighing mode.



Initial Range	Model
0.2g	HF-200, HF-300, HF-320, HF-400
2.0g	HF-2000, HF-3000, HF-3200, HF-4000, HF-6100
10g	HF-6000, HF-8000

○ Animal Mode Stabilization range:

This mode corresponds to internal setting $[- 0]$, $Stb - b$ in the following way:

$[- 0]$	<input type="checkbox"/>	This indicator lights when weighing data is averaged within the range set below.
$Stb - b$ Stability band width	0	Stable when within $\pm 6.25\%$ of the weighing value.
	*1	Stable when within $\pm 12.5\%$ of the weighing value.
	2	Stable when within $\pm 25\%$ of the weighing value.
		To measure most precisely, but slow to stabilize
		To eliminate vibration and to stabilize quickly

* factory setting

○ Animal Weighing Averaging Time:

This mode corresponds to function $[- 0]$, $[and]$ Condition in the following way:

$[- 0]$ $[and]$ Response / Environment		Averaging Time	Better weighing conditions faster weighing response Worse weighing conditions slower weighing response
	0	1 sec	
	1	2 sec	
	*2	4 sec	
	3	6 sec	
4	8 sec		

* factory setting

Animal Weighing - Example of Use

1 Select animal weighing mode using the **MODE** key. (model HF-300 illustrated)

2 Place a tare container on the pan and press **RE-ZERO**. The display will show zero.

3 Place the animal in the tare container.

4 When the animal weighing mark is lit, read the displayed weight.

5 Remove the animal. The display will return to zero.

Animal weighing mode indicator

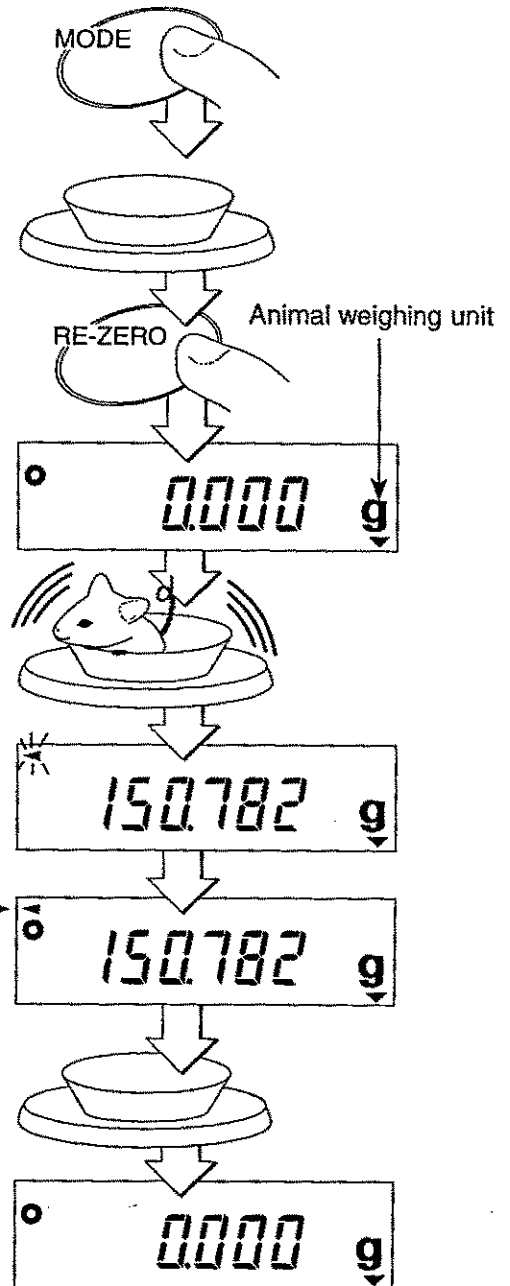



Environment Response Adjustment

The HF series has three functions to adapt the balance to environmental changes.

Condition response rate

Use this setting when you want a reading as quickly as possible or a reading as stable as possible. This parameter is common data with the "Response / Environment" function. Refer to "Functions" and the Condition of Response procedure.

Calibration

This mode allows recalibration, canceling possible weighing error due to gravity, altitude, air pressure, ambient temperature and humidity using a calibration mass. Please use a calibration mass sufficiently precise to recalibrate the balance to the smallest digit of the display.

Please calibrate the balance when you move the balance or perform the periodical maintenance. Refer to "Calibration".

Function

The HF series has a number of internal software parameters so that you are able to select the best weighing features for your needs. Refer to "Function".



Conditions of response



In this procedure, If you do not complete the next steps within five seconds, the balance will return to weighing mode without saving the new parameter.

Conditions Determining Response Rate

Parameter setting		
Cond	0	better weighing conditions faster weighing response
	1	
	*2	worse weighing conditions slower weighing response
	3	
	4	

* factory setting

- 1 Press and hold the **MODE** key. The balance will change to the "Condition of response" mode and the display will show the "Cond".

This mark displays while a memorized parameter

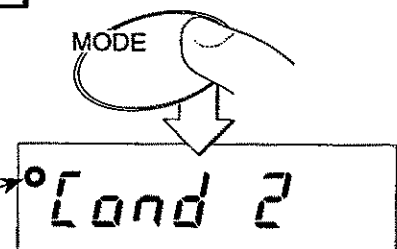

- 2 Press the **RE-ZERO** key several times until the parameter you want is displayed.

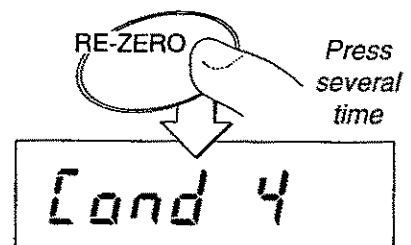

- 3 Press the **PRINT** key. The balance will change to weighing mode, saving the new parameter. This is stored in the balance memory, even if the AC adaptor or optional battery is removed from the balance.

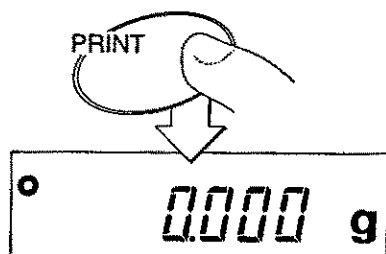



Calibration



Prevent vibration, drafts, and ambient temperature changes from affecting the balance during calibration.

- To get the output for Good Laboratory Practice (GLP) set "output of calibration" ([-4, INF]) before you perform the calibration.
- Please use a very precise calibration mass. The accuracy of your balance is decided by this calibration mass.
- If you want only zero-point-calibration, a calibration mass is not needed.
- Please select your calibration mass from following table. The preferred calibration mass is the value in type and is selected when the balance enters the calibration mode.

Model - Number

HF-200	100g	200g							
HF-300		200g	300g						
HF-320		200g	300g						
HF-400		200g	300g	400g					
HF-2000				1kg	2kg				
HF-3000					2kg	3kg			
HF-3200					2kg	3kg			
HF-4000					2kg	3kg	4kg		
HF-6100						3kg	4kg	5kg	6kg
HF-6000						3kg	4kg	5kg	6kg
HF-8000							4kg	5kg	6kg 7kg 8kg



Displays and canceling calibration



This mark means the balance is proofing calibration data. Do not allow vibration or drafts to affect the balance while this mark is displayed.

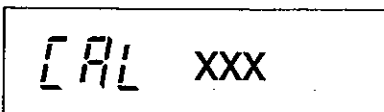

- XXX = [] balance is executing zero-point-calibration.
- XXX = (except zero) show the required calibration mass weight and means to be executing full-scale-calibration.

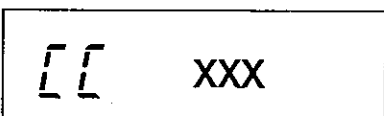

- XXX = [] means to be executing zero-point-check.
- XXX = (except zero) show the required calibration mass weight and the balance is executing full-scale-check.

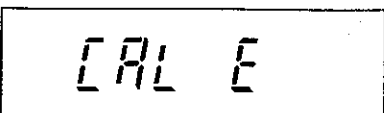

"CAL E" will be displayed if the calibration mass is too heavy.

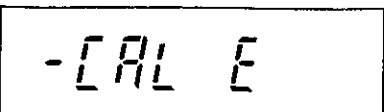

"-CAL E" will be displayed if the calibration mass is too light.

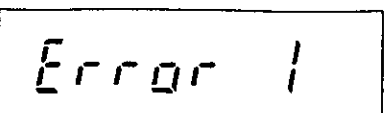

Warning of instability due to vibration or drafts. Please check ambient conditions. Also see "Conditions". If you choose eg. Cond 3 or 4 you are likely to have a more stable reading.

ON:OFF

The **ON:OFF** key cancels the execution of calibration without saving new data and the display turns off.

Calibration Procedure

The simplest way to perform a zero point and full-scale calibration is shown below. This assumes that parameter '[4 - INF 0]' is set to 'no output'. Refer to the following section for a detailed explanation of the full calibration procedure. This illustration is for model HF-300.

- 1** Warm up the balance for at least one hour with nothing on the weighing pan.
- 2** Turn the display on.
- 3** Press and hold the **RE-ZERO** key to enter calibration mode. Release the key when the balance displays **[CAL 0]**. When you press and hold the **RE-ZERO** key, the balance may display other values without **[CAL 0]** or **[CAL 0]**. Please refer the manual for the options in use.
- 4** Setting the value of the calibration mass. Press the **MODE** key. A digit to enter a number will alternate on and off.
- 5** Enter the calibration mass value using the following keys.

MODE key	Used to move digit to enter a number.
RE-ZERO key	Used to enter a number.
PRINT key	Used to register the new calibration mass value.

- 6** Verify that there is nothing on the weighing pan. Press the **RE-ZERO** key. The balance measures the zero point.

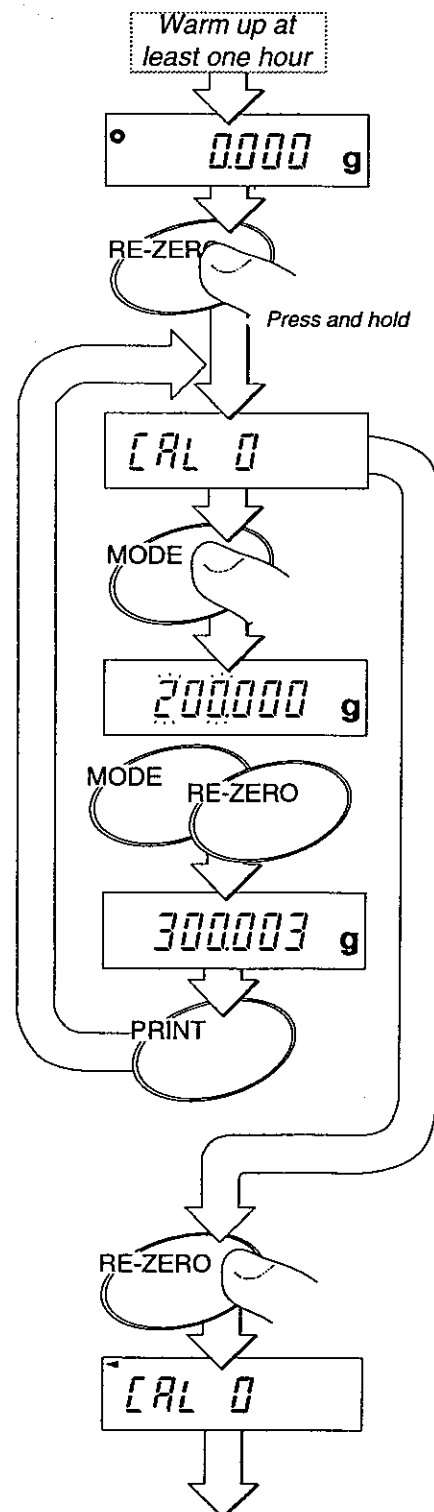

7 `CAL 300` will be displayed. Place the calibration mass on the pan.

8 Press the `RE-ZERO` key. The balance measures the weight.

9 `CAL End` is displayed. The calibration is finished.

10 Remove the calibration mass from the pan. To check the weighing calibration place the calibration mass back on the weighing pan, verifying its value.

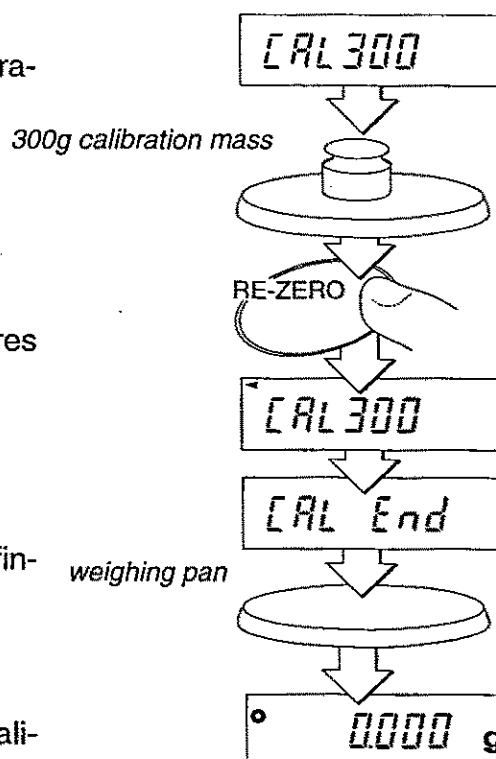

Zero-point-calibration

If the balance displays `-E` or `-----` when the balance is turned on, with the weighing pan properly installed and on which is nothing is placed, it means that the zero point has shifted. It is necessary to perform the Zero-calibration. Refer to the following page.

Caution The decimal point position and/or weight values are different depending on the balance model. The following procedure assumes that the internal settings are set at `[- 3] [CAL 2]` and `[- 4] [10 F 0]` (manufactures setting). Please confirm that you have the proper settings before attempting zero-calibration.

RE-ZERO

The **RE-ZERO** key is used to select a parameter for the item selected by the **MODE** and **SAMPLE** keys.

PRINT

The **PRINT** key is used to save the new C-parameter settings and to exit to the weighing mode.

ON:OFF

The **ON:OFF** key cancels the new C-parameter settings and turns the display off.

Internal parameter setting

- 1** Turn the display off.
- 2** Press and hold the **RE-ZERO** key and press the **ON:OFF** key. Release both keys.
- 3** Press the **MODE** key. The balance enters the function setting mode and **[- 0]** will be displayed.
- 4** Set the C-parameter using the keys described on the preceding page.

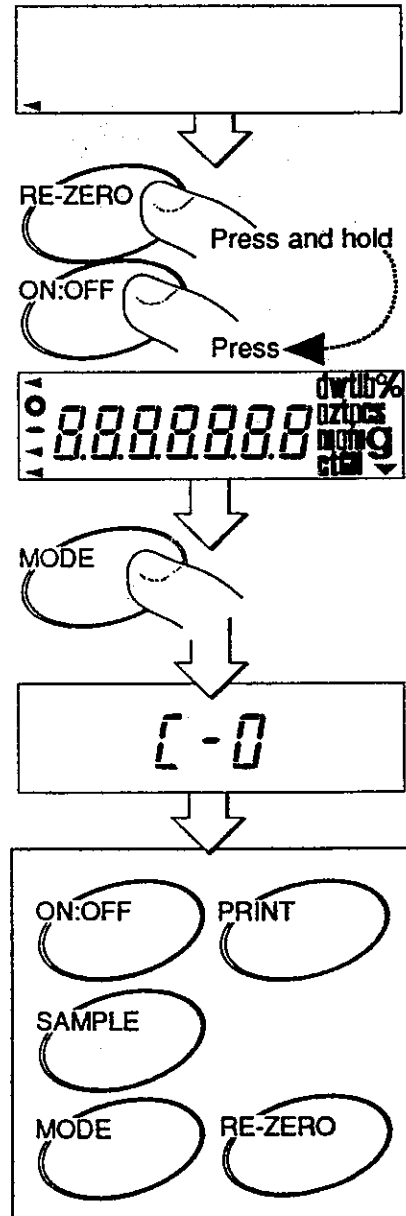



Functions



Your HF balance has a number of internal software parameters that enable you to select the best weighing features for your needs. These settings control how you want the balance to respond to its environment, various commands, operations and options. An overall parameters table is shown below.

All of the parameters have initial settings from the factory, or possibly from your dealer. You may easily change these settings as you need them, or conditions vary.

These settings are stored in the balance until the next change even without the AC adaptor or optional battery. The section, C-parameter keys and displays, explains how to change the parameter. The individual settings for each group are detailed in the following section, C-parameter settings.

Group Number	Item and Item Number							
	Group	0	1	2	3	4	5	6
0	C-0 Environment	Stb-b Stability band	Cond Resp. / Environ.	trc Zero tracking				
1	C-1 Display update	SPEED Refresh rate	Point Decimal point	P-on Auto start function	r-RNGE Minimum display			
2	C-2 Auto re-zero	Ar-0 Auto re-zero on/off	Ar-b Auto re-zero band	Ar-t Detection time				
3	C-3 Calibration	CAL Calibration inhibit						
4	C-4 Data out	Pr int Data out mode	AP-P Auto print polarity	AP-b Auto print band	PAUSE Data pause	At-F Auto feed	Ar-d Zero after data out	info Cal verification
5	C-5 Serial interface	bPS Baud rate	bt-Pr Length, Parity bit	Cr-LF Terminator	TYPE Data format	t-UP Receive time	E-Cod Error code	CTS CTS control
6	C-6	Response/environment is common data with the condition of response accessible using the keyboard. If a value is set in the C parameters, it will be changed if new conditions of response are set.						
7	C-7							
8	C-8							
9	C-9 Parameter control	Pn ID protect	PF Parameter protect					

Some products can not select this function



C-parameter keys and displays



This mark appears when the memorized parameter is displayed.



The **MODE** key is used to select the group of C-parameters.



The **SAMPLE** key is used to select the item from the group selected by the **MODE** key.

RE-ZERO

The **RE-ZERO** key is used to select a parameter for the item selected by the **MODE** and **SAMPLE** keys.

PRINT

The **PRINT** key is used to save the new C-parameter settings and to exit to the weighing mode.

ON:OFF

The **ON:OFF** key cancels the new C-parameter settings and turns the display off.

Internal parameter setting

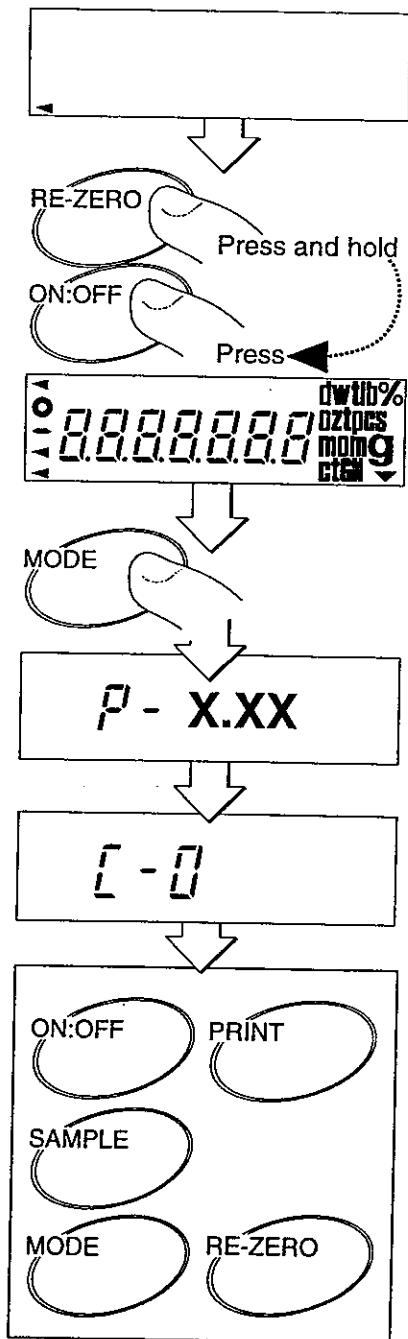

- 1** Turn the display off.
- 2** Press and hold the **RE-ZERO** key and press the **ON:OFF** key. Release both keys.
- 3** Press the **MODE** key. The balance enters the function setting mode and **[-]** will be displayed.
- 4** Set the C-parameter using the keys described above and on the preceding page.

X.XX in the display is the software version.



C-Parameter Settings

[- 0] Environment: The settings adjust the balance to your environment.

Stb-b Stability band width		<input type="checkbox"/> The Stability indicator lights when the display fluctuation is within the range set below	
	0	Stable when within ± 1 digit half second.	
	*1	Stable when within ± 2 digits half second.	
	2	Stable when within ± 3 digits half second.	
Cond Response / Environment	0	Better weighing conditions faster weighing response  Worse weighing conditions slower weighing response 	
	1		
	*2		
	3		
	4		
Trc Zero tracking	0	Zero tracking OFF	The balance tracks zero-drift caused by change of temperature, humidity, air pressure, etc., and stabilizes the ZERO point. Display continues to ZERO if the drift is less than 1 digit per average. If weighing very light samples, select a lower number (weak tracking).
	1	Weak zero tracking	
	*2		
	3		
	4		



* factory setting.

[- 1] Display Update, Decimal Point and Auto Start

SPEED Display update rate	parameter	The setting of the period to refresh the display	
		Software version ~2.02	Software version 2.03~
	*0	5 times/second type at stable weighing 10 times/second type at unstable weighing	5 times/second
	1	5 times/second	10 times/second
Point Decimal point display	*0	Point (.)	
	1	Comma (,)	
P-on Auto start function	*0	No auto start	Chose whether the display is to come on automatically without using the ON:OFF key when power is supplied.
	1	Auto start	
r-RANGE Minimum figure	parameter	The setting to display the minimum figure when you start weighing. The minimum figure can be turned on/off by pressing the SAMPLE key alternately. Caution <ul style="list-style-type: none"> • This function can not be used in the counting or percent mode. • There are some products that can not select this function 	
	*0	The minimum figure is displayed at turn-on	
	1	The minimum figure is not displayed at turn-on	

* factory setting

[- 2] Auto Re-ZERO Function

<i>Ar-0</i> Auto Re-Zero function when near Zero	*0	Auto Re-ZERO off	
	1	Auto Re-ZERO on	•Auto Re-ZERO occurs when display is \pm 'Ar-b' digits for the time 'Ar-t'
<i>Ar-b</i> Auto re-zero band	*0	Zero when within ± 5 digits of the zero-point.	slow Re-ZERO
	1	Zero when within ± 50 digits of the zero-point.	
	2	Zero when within ± 500 digits of the zero-point.	
<i>Ar-t</i> Time for auto zero determination	*0	Re-ZERO when near zero for more than a half second.	fast Re-ZERO
	1	Re-ZERO when near zero for more than 1 second.	
	2	Re-ZERO when near zero for more than 2 seconds.	
	3	Re-ZERO when near zero for more than 4 seconds.	

* factory setting

[- 3] Keys that can be used for calibration.

<i>CAL</i> Calibration keys accepted	0	Keyboard and EXT. switch can not be used.
	1	Keyboard can be used, EXT. switch can not be used.
	*2	Keyboard and EXT. switch can be used.

* factory setting

[- 4, [- 5: Please refer to the instruction manual for the separately available options

[- 9]

C-parameter control

<i>Pn</i> ID protect	parameter	Parameter definition and use. Determines whether a change is permitted to the ID number
	*0	Permits a change to the ID number
	1	Inhibits a change to the ID number
<i>PF</i> Parameter protect	parameter	Parameter definition and use.
	*0	Permits a change to the C-parameters
	1	Inhibits a change to the C-parameters.
	2	The C-parameters are changed to the original factory settings.

* factory setting



The ID number and GLP

- The ID number is used to identify the balance when using Good Laboratory Practice (GLP).
- Option 03 or 05 is necessary to output the balance data using the ID number.
- The data can be transmitted to an AD-8121 printer or a computer using option 03 or 05.
- Verifying the calibration executes using the ID number and weighing data after the calibration. The AD-8121 printer will add the date and time.
- Refer to the Function "Verifying the calibration". ([- 4 INF 0, page 25)



Setting the ID number



The ID number is saved in the balance memory without the AC adaptor or optional battery connected and is effective until the next change.
The ID number was set to **00000000** at the factory.



If you do not complete steps 2 and 3 within five seconds, the balance returns to the weighing mode without saving the new ID number.

- 1** Turn the display off.
- 2** Press and hold the **[SAMPLE]** key and press the **[ON:OFF]** key.
- 3** Press the **[MODE]** key. The ID number will blink.

Set your ID number using following keys.

RE-ZERO

The **[RE-ZERO]** key is used to change the character that is displayed. You can select following characters.

0-9, -, (space mark), and A-Z.

Refer to the following section 'Display Character Set'.

SAMPLE

Switches between numbers and letters.

MODE

The **[MODE]** key is used to shift the character that is displayed.

PRINT

The **[PRINT]** key saves the new ID number and go to the weighing mode.

ON:OFF

The **[ON:OFF]** key turns the display off without saving the new ID number.

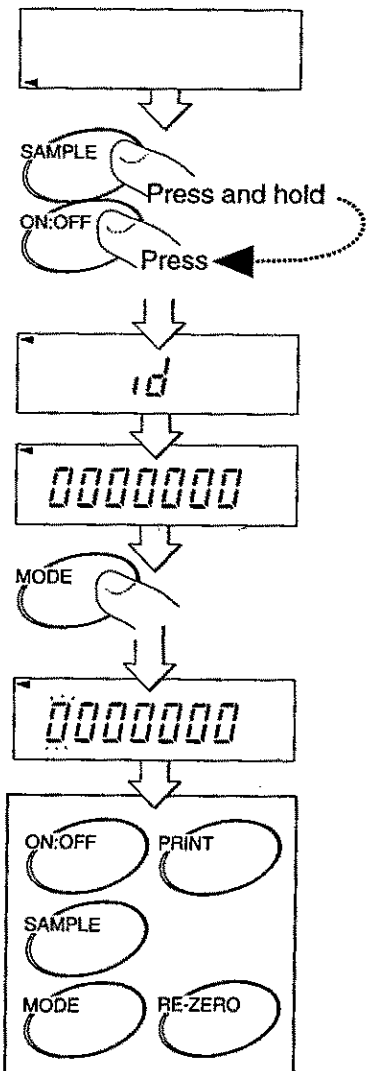

Display Character Set:

A	B	C	D	E	F	G	H	I	J	K	L	M	N	O	P	Q	R	S	T	U	V	W	X	Y	Z
R	b	l	d	E	F	G	H	i	U	Y	L	n	n	a	P	q	r	S	t	U	u	y		Y	l
1	2	3	4	5	6	7	8	9	0	-	(Space)														
1	2	3	4	5	6	7	8	9	0	-	Space : while flashing display "-"														



Miscellaneous



Digital Tare



Instead of placing a container on the balance and pressing the **RE-ZERO** key, you can enter the weight of the container via this Digital Tare. The Digital Tare range is from zero to maximum capacity.



If you press the **RE-ZERO** key, The balance will store the value of the weight on the pan into *Pt*.

If you do not complete steps 2 and 3 in five seconds or less, the balance returns to the weighing mode.

1

Turn the display on.

2

Press and hold the **SAMPLE** key until the balance displays *Pt*. (Preset Tare)

3

Press the **RE-ZERO** key. The value of digital tare will be displayed. If you want to change the value, press the **MODE** key.

4

Set the digital tare that you want using following keys.

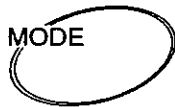

The **MODE** key is used to select the figure to be changed.



The **RE-ZERO** key is used to change the number that is displayed.



The **PRINT** key saves the new Digital Tare value and returns to the weighing mode.



The **ON:OFF** key turns the display off without saving the new Digital Tare.

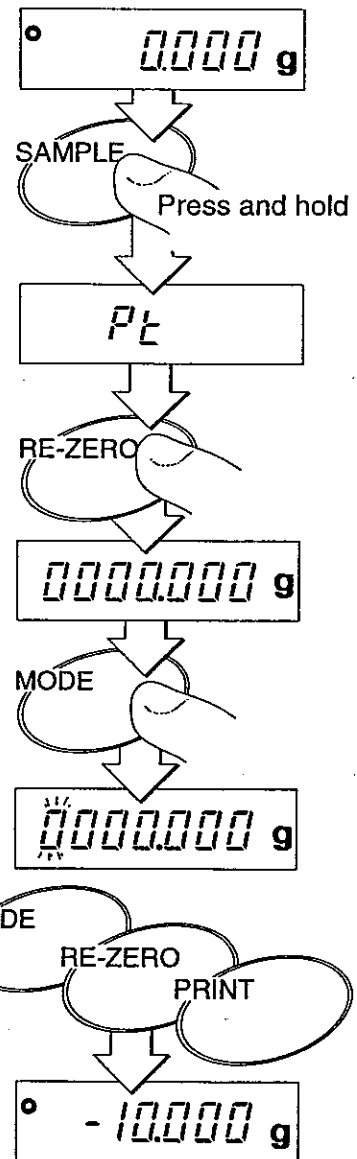

When you press the **RE-ZERO** key, the value set into the Digital Tare is cleared.



External key connector

An external connector plug is supplied, to enable remote control of the balance. When this plug is connected, RE-ZERO and Print instructions can be sent to the balance. Refer to the diagram below. You must short the GND line to the PRINT or RE-ZERO line for at least 100ms.

In the following example, the Print switch is turned on.

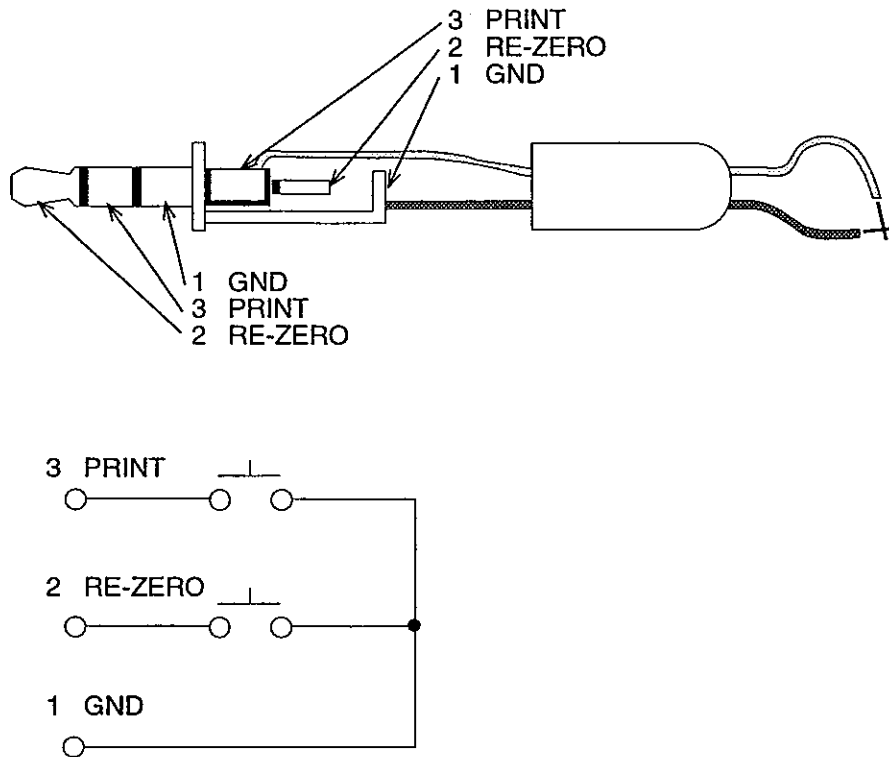

Part name: AX-T-314A-S

Underhook Weighing

The HF series balances are equipped with a standard built-in underhook. This makes density determination a relatively simple matter. Also use the underhook to weigh magnetic material.

- 1** You can find the underhook behind the plastic plug on the under-side of your balance.
- 2** Place the balance on a weighing table with a hole cut in it or place it on a firm metal stand designed for underhook weighing.
- 3** Hang a light-weight weighing harness from this hole or thread a strand of thin string /wire through it.
- 4** For best results recalibrate the balance with the harness in place.

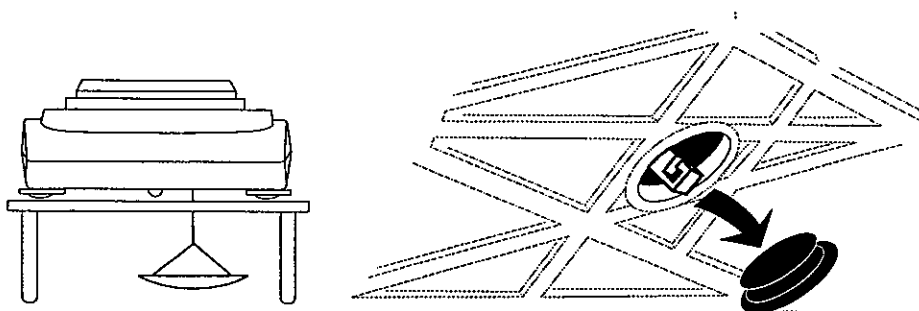

An Example of Underhook Weighing

- 1** Place the material on the harness.
- 2** Find the weight A of the material in air.
Press the **RE-ZERO** key.
- 3** Lower the material into water at 10 °C.
- 4** Find the weight B of the material in water.
- 5** Find a water density C from following table.

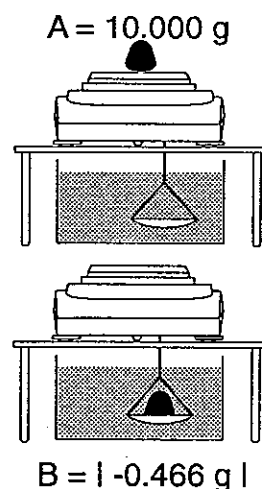

0°C	0.99984 g/cm ³
4	0.99997
10	0.99970
15	0.99910
20	0.99821
25	0.99705
30	0.99565 Reference

$$\text{Volume} = \frac{0.466 \text{ g}}{0.99970 \text{ g/cm}^3} = 0.4661 \text{ cm}^3$$

$$\text{Density} = \frac{10.000 \text{ g}}{0.4661 \text{ cm}^3} \approx 21.45 \text{ cm}^3$$

- 6** This material is most likely platinum.



Errors and Specifications



Errors

Low battery



This low battery mark indicates that the battery power has become too weak for reliable weighing. If you find this **Lb** mark, stop the operation and charge the battery, using the AC adaptor.

Over load Error



This display indicates that the weight placed on the pan is beyond the balance capacity.

Weighing pan Error

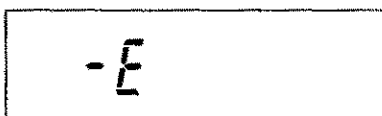

This display indicates that the weighing pan or the pan support are not properly installed.

Power failure Error

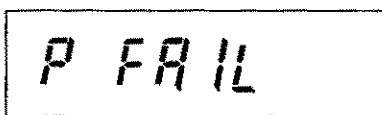

This display indicates that power was interrupted during weighing the last time the balance was used. Press the **ON/OFF** key to clear.

Stability Error

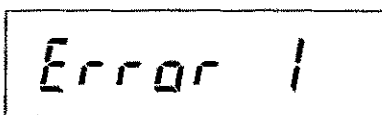

This display indicates that the balance can not become stable while zeroing or weighing. Check for excessive vibration or drafts. Press the **RE-ZERO** key to clear.

Digital Input Error



This display indicates that unacceptable Digital data was input.

Zero-point Error

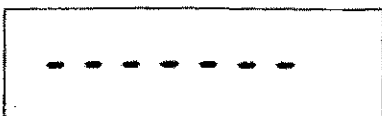

This display indicates that the zero-point of weighing has drifted from last calibrating zero-point (**[CAL 0]**). Make certain that there is nothing on the weighing pan. Press the **RE-ZERO** key to display normal weighing and execute calibration to reset the zero-point (**[CAL 0]**).

CAL Errors

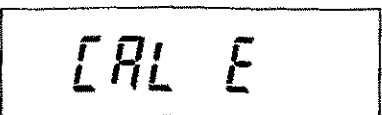

This display indicates that the calibration mass is too heavy.

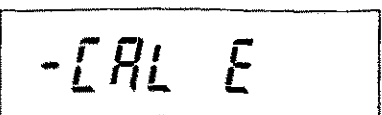

This display indicates that the calibration mass is too light.

Unit weight Error

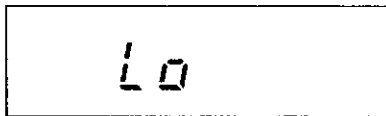

The sample weight is very light. The balance can not calculate the unit weight or 100% weight.

Sample quantity Notice

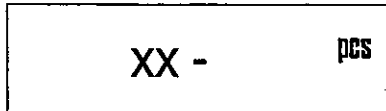

If samples are lighter than the correct value, counting error becomes too large and the balance requests additional samples. Add the requested samples to the pan and press the **[SAMPLE]** key to store the correct value.

xx=20, 30, 40, 50, 60, 70, 80, 90, 100

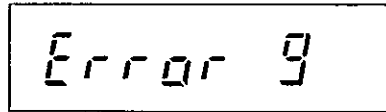
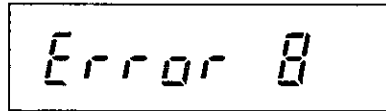
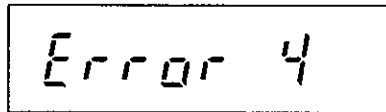
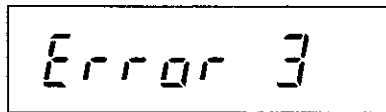
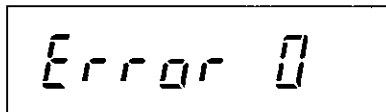

The balance needs repair. Request service to the store where you purchase it, or the A&D service group.



Specifications

Model	HF-200	HF-300	HF-400	HF-2000	HF-3000	HF-4000	
Weighing Capacity	g	210	310	410	2100	3100	4100
Min. weighing Display	g	0.001			0.01		
Min.100% weighing	g	0.100			1.00		
Min. unit weighing	g	0.001			0.01		
Repeatability (Standard Deviation)	g	0.001			0.01		
Linearity	g	± 0.002			± 0.02		
Sensitivity Drift	ppm/°C	± 2 *					
Stabilization Time	sec.	1.5					
Pan Size	mm	Ø 120			Ø 155		
Calibration Mass	g	100	200	200	1000	2000	2000
		200	300	300	2000	3000	3000
				400			4000
Net Weight	kg	3.3			3.6		
Operating Temperature		0°C - 40°C, RH < 85%, do not allow condensation to form					
Power Supply		AC adaptor, 11VA approximately or optional battery pack					
Display Update Rate		10 times/second, 5 times/second					

Model	HF-6100	HF-6000	HF-8000	HF-320	HF-3200	
Weighing Capacity	g	6100	6100	8100	310 / 60	3100 / 600
Min. weighing Display	g	0.01	0.1		0.01 / 0.001	0.1 / 0.01
Min.100% weighing	g	1.00	10.0		1.00	10.0
Min. unit weighing	g	0.01	0.1		0.01	0.1
Repeatability (Standard Deviation)	g	0.01	0.1		0.005 / 0.001	0.05 / 0.01
Linearity	g	± 0.03	± 0.1		± 0.0 / ± 0.002	± 0.1 / ± 0.02
Sensitivity Drift	g	± 2 *	± 5 *			
Stabilization Time	sec.	2	1.5			
Pan Size	mm	Ø 155	192.5 x 174		Ø 120	Ø 155
Calibration Mass	g	3000	3000	4000	200	2000
		4000	4000	5000	300	3000
		5000	5000	6000		
		6000	6000	7000		
			8000			
Net Weight	kg	3.6	3.9		3.3	3.6
Operating Temperature		0°C - 40°C, RH < 85%, do not allow condensation to form				
Power Supply		AC adaptor, 11VA approximately or optional battery pack				
Display Update Rate		10 times/second, 5 times/second				

* Temperature range of Sensitivity Drift is 10°C - 30°C.



Dimensions

HF-200
HF-300
HF-320
HF-400

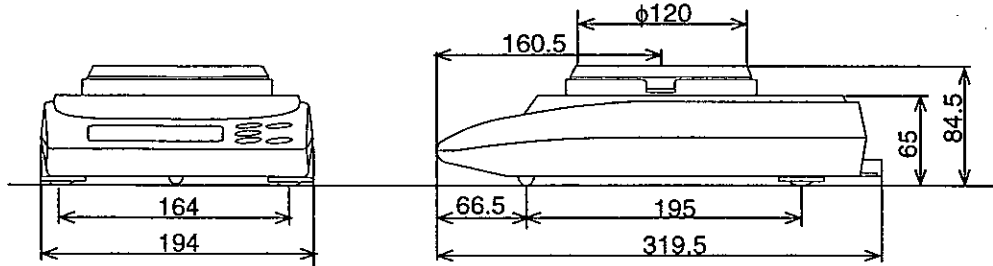
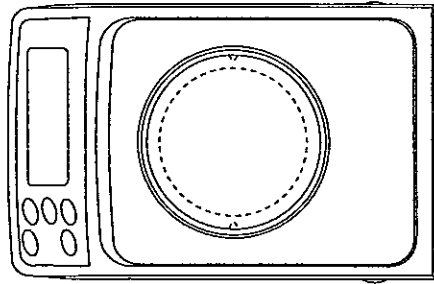

HF-2000
HF-3000
HF-3200
HF-4000
HF-6100

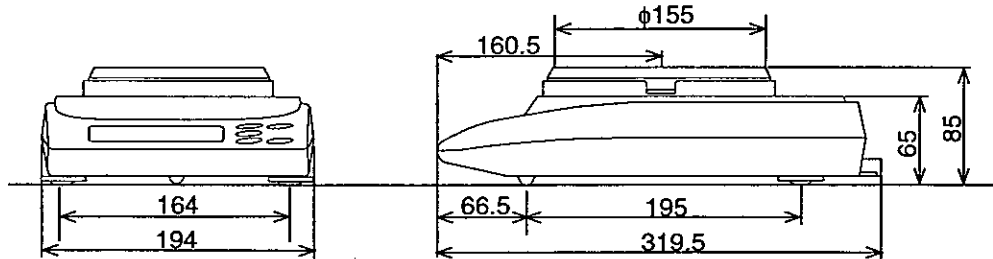
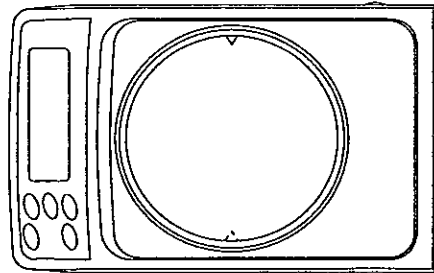

HF-6000
HF-8000

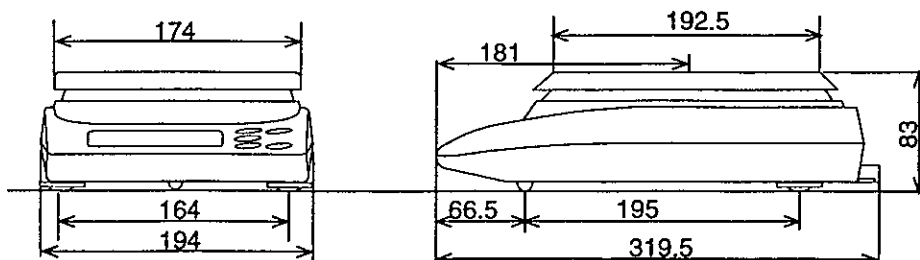
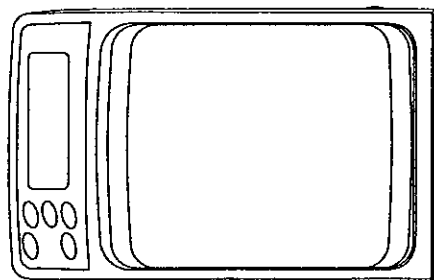

-----25,26,36

A

AC adaptor-----4,38
 AD-8121 -----3,31
 AP-b -----27
 AP-P -----27
 Ar-O -----27,30
 Ar-b -----27,30
 Ar-d -----27
 Ar-t -----27,30
 At-F -----27

B

bE-Pr -----27
 bP5 -----27

C

C-O -----20,27,28,29
 C-1 -----27,29
 C-2 -----27,30
 C-3 -----25,27,30
 C-4 -----23,25,27
 C-5 -----27
 C-9 -----27,30
 CAL -----23,24,25,26,27,30
 -CAL E -----23,36
 CAL E -----23,36
 CC -----23
 Cond -----20,22,27,29
 Cr-LF -----27
 CTS -----27

E

E -----25,26,36
 -E -----26,36
 E-Code -----27
 Error 1 -----23,26,36
 Error 2 -----36
 Error 0348.9 -----37

G

GLP -----3,31

I

ID -----31
 id -----31
 info -----23,25,27

L

Lb -----36
 Lo -----11,13,37

P

P FAIL -----26,36
 P-on -----27,29
 PAUSE -----27
 PF -----27,30
 Pn -----27,30
 Pa int -----27,29
 Pr int -----27
 Pt -----16,18,33
 PU -----18

R

RS-232C -----3
 rRange -----27,29

S

SPEED -----27,29
 Stb-b -----20,27,29

T

t-UP -----27
 trc -----27,29
 tYPE -----27

U

Unit -----11
 UU -----16