

HA SERIES

INSTRUCTION MANUAL

Owners-HA Series-V.1.a 91.11.25 OGA

PRECISION ELECTRONIC BALANCES

MODELS : HA180M
HA120M



FCC Rules

Please note that this equipment generates, uses and can radiate radio frequency energy. This equipment has been tested and has been found to comply with the limits of a Class A computing device pursuant to Subpart J of Part 15 of FCC rules. These rules are designed to provide reasonable protection against interference when equipment is operated in a commercial environment. If this unit is operated in a residential area it might cause some interference and under these circumstances the user would be required to take, at his own expense, whatever measures are necessary to eliminate the interference.

(FCC = Federal Communications Commission in the U.S.A.)



Table of Contents

Section A • Set-UP	page A • 1
Unpacking Your HA	page A • 2
Best Conditions For Weighing	page A • 3
Setting Up Your HA Balance	Page A • 4
Power Supply Notes	page A • 5
Display-off State	page A • 5
Display ON & Power Errors	page A • 5
Section B • Introduction	page B • 1
Specifications	page B • 2
Dimensional Outline Drawing	page B • 3
Features	page B • 4
Options.....	page B • 4
Stand-by State	page B • 5
Door Opening/Closing	page B • 5
C-Parameter Settings	page B • 6
The Display and Keyboard	page B • 7
ON : OFF key	page B • 7
MODE key	page B • 8
PRINT key	page B • 8
CAL key	page B • 8
RANGE key	page B • 9
RE-ZERO key	page B • 9
Selecting Weighing Units	page B • 10
To Turn Weighing Units OFF or ON	page B • 10
Setting and Checking Arbitrary Coefficient	page B • 12
Weighing Units and Their Conversions	page B • 14
Section C • Calibration	page C • 1
Calibration	page C • 2
Auto Self-calibration	page C • 3
Auto Calibration	page C • 4
Auto Calibration Check	page C • 4
Manual Calibration	page C • 5
Changing the Set Value of a Calibration Weight	page C • 6
Calibration Notes and Errors	page C • 6

Section D • Weighing Mode	page D • 1
Simple Weighing	page D • 2
Weighing Error	page D • 3
Using RE-ZERO to Tare	page D • 4
Making More Precise Weighing	page D • 5
Re-zero/Print Operation via External Input Terminal	page D • 6
Underhook Weighing	page D • 7
Underhook Weighing Example	page D • 7
Section E • Internal C-Parameter Settings	page E • 1
Internal C-Parameter Settings	page E • 2
Changing C-Parameter Settings	page E • 3
The C-Parameter Settings (C0 to C6)	page E • 4
C0 Environment	page E • 4
C1 Display	page E • 6
C2 Calibration	page E • 7
C3 Auto Re-zero	page E • 8
C4 Restriction of Setting and Others	page E • 9
C5 Data Output	page E • 10
C6 Serial Interface (OP-03)	page E • 12
Section F • Serial Interface OP-03 (Option)	page F • 1
OP-03 Installation	page F • 2
Specifications	page F • 2
Computer Connection	page F • 2
RS-232C Pin Connection	page F • 3
OP-03 Circuit Diagram	page F • 3
OP-03 Data Output	page F • 4
Print Key Mode	page F • 4
Auto Print Mode	page F • 4
Stream Mode	page F • 5
Command Mode	page F • 5
Connection to AD-8117	page F • 6
Connection to AD-8117A	page F • 7
Sample Computer Programs	page F • 8
Weighing Data Output Format	page F • 9
A&D Standard Format	page F • 9
AD-8117A Format	page F • 9

KF Format	page F • 9
Weighing Data Format Examples	page F • 10
Stable Data Examples	page F • 10
Unstable Data Example	page F • 11
Overload Data Examples	page F • 11
Independent Data Formats	page F • 12
Data No.	page F • 12
Code No.	page F • 12
Parameter Setting Value	page F • 12
Various Commands for the RS-232C Serial Interface	page F • 13
Error Codes for the Serial Interface	page F • 20
Command Examples Illustrated	page F • 23
"P" "ON" Command (Display ON/OFF)	page F • 23
"R" Command (Re-Zero)	page F • 24
Section G • Vibro Spoon AD-1651 (Option)	page G • 1
Vibratory Spoon AD-1651	page G • 2
Target Weight	page G • 2
Notes on Feeding Accuracy	page G • 3
Setting (or Viewing) the Target Weight	page G • 3
Setting (or Viewing) the Target Weight (RS-232C)	page G • 4
To START Spoon Feeding	page G • 5
To STOP Spoon Feeding	page G • 5
Connector Hook-up	page G • 5
Section H • Anti-theft Device OP-11 (Option)	page H • 1
OP-11 Installing Procedure	page H • 2
Section I • Troubleshooting	page I • 1
Trouble	page I • 2
Fuse Replacement	page I • 3
Error Display and Countermeasures	page I • 3
Maintenance	page I • 6

HA SERIES • Section A

Set-Up

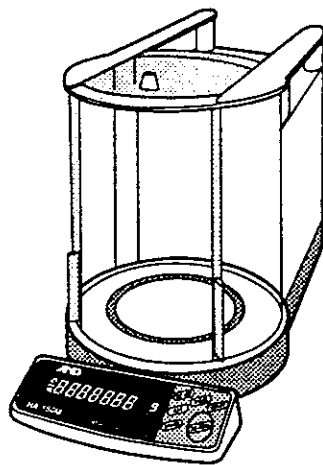

Unpacking Your HA

Main Body

! Special care should be taken when handling a precision balance. It may be convenient to keep the packing material, should the balance require later movement, shipping or storage.

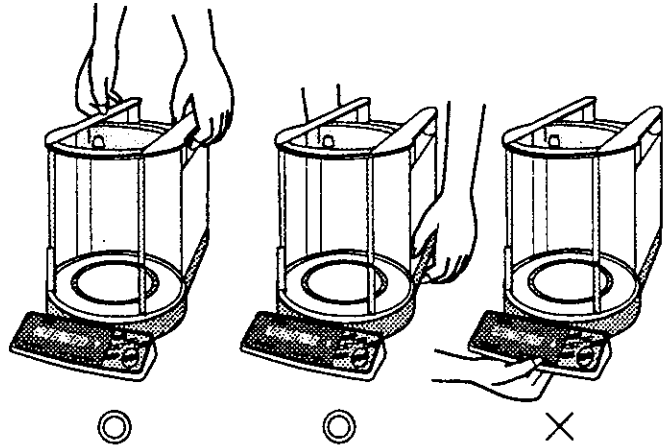
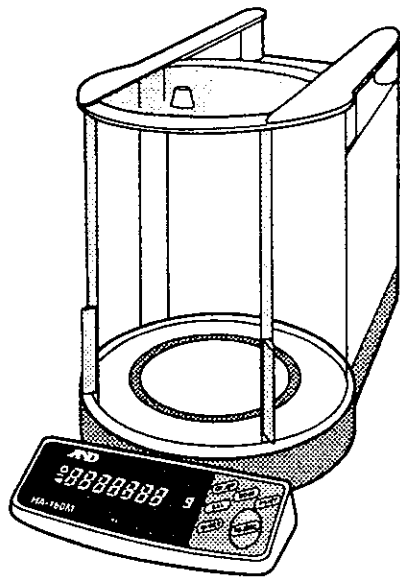

▶ In addition to this manual, the package contains the following components:

Accessories

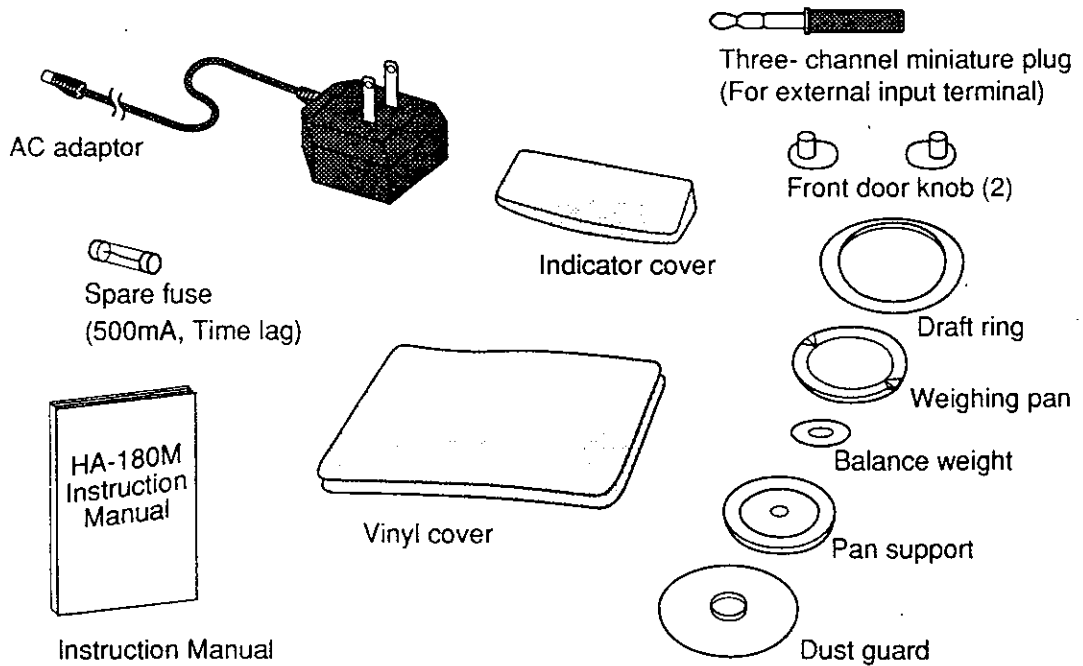



Best Conditions for Weighing



To obtain the best performance using the HA series electronic force balance, follow the installation conditions indicated below:

- Level the balance. (Check using the level gauge on the rear of the balance.)
- Ideal ambient temperature and humidity should be $20^{\circ}\text{C}\pm 2^{\circ}\text{C}$ and 45 to 60%RH, respectively.
- The room in which the balance is used should be free of dust.
- The balance should be placed on a hard stable surface.
- Measurements should be made with the balance located near the corner of the room. There usually is less vibration and traffic in corner areas.
- Do not install the balance in the draft from an air conditioning vent.
- Do not install the balance in direct sunlight.
- Do not install the balance near equipment that generates a magnetic field, or that may be affected by the magnetic field of the balance.
- Be sure to warm up the balance one hour or more before use. Place it in the stand-by state (display-off state, refer to **page A•5**) after use.

Setting Up Your HA Balance

1 Put the balance on a hard stable surface (refer to Best Conditions For Weighing on the **previous page**), and insert the AC adaptor plug. **1**

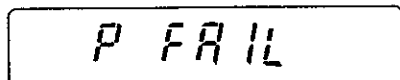

Upon application of power, "P F A I L" may be displayed. → Refer to the **next page**.

2 Adjust the leveling feet **2** so that bubble in the level gauge **3** is located at the center of the red circle. Set the dust guard, draft ring, pan support, balance weight, and weighing pan.

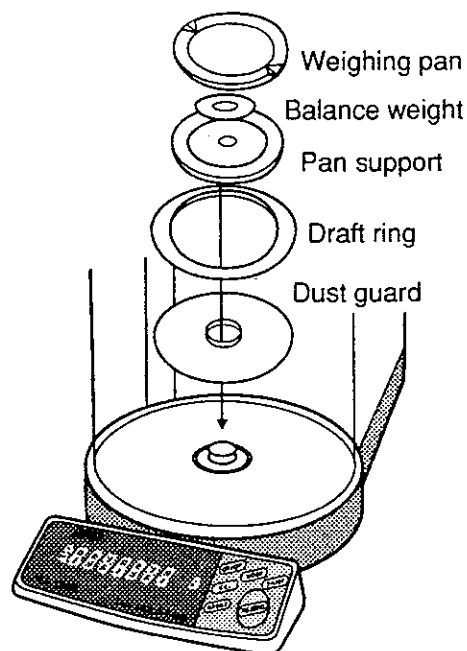
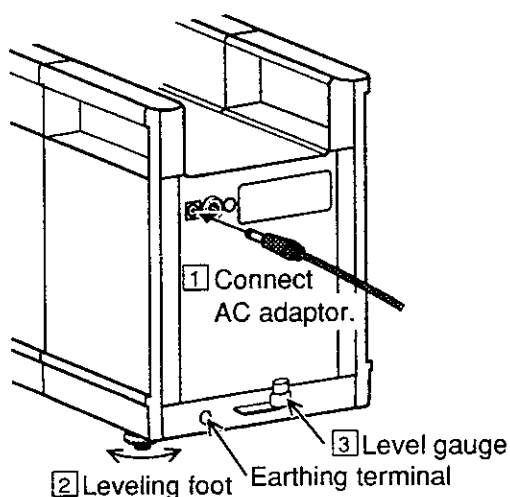

3

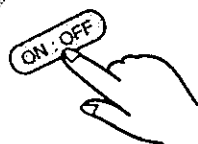

- ▶ Press the **ON:OFF** key.
- All displays should illuminate.
- Zero should then be displayed.

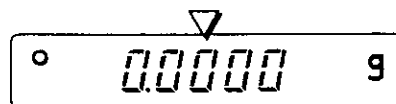
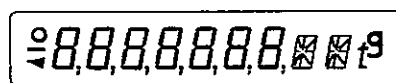

4

Insufficient warm-up may cause an inaccurate measured value. Connect the AC power and allow at least one hour for the balance to warm up.

5

Perform auto calibration once the balance has warmed up. (Refer to "Auto Calibration" on **page C-4**.)

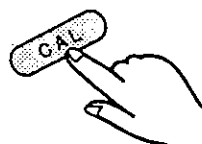

- ▶ Press the **CAL** key.

Power Supply Notes

-  As long as the AC adaptor is connected, the balance is always in the energized state. This state will not adversely effect the balance. Before using, be sure to energize (warm up) the balance at least one hour.

Display-off State

- With the AC adaptor connected to the balance, the display remains off due to the “**Display-off State**”. In this case, there are two types of displays as indicated below:

- Power indicator

The rightmost decimal point should illuminate.

This display usually appears in the display-off state.

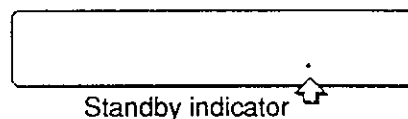

- Power failure

“*P FAIL*” appears when the power is interrupted (due to power failure) during normal use.

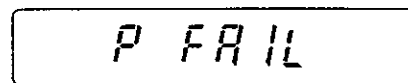

Display ON & Power Errors

-  When the power is applied or turned on, the balance self-diagnoses any possible errors in its operation. If an error is detected, the error display will appear.

- Power failure

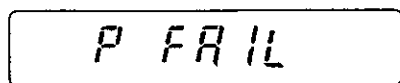

“*P FAIL*” appears when the power is interrupted during normal use

- Press the **ON:OFF** key.

- Error indicating an unstable state

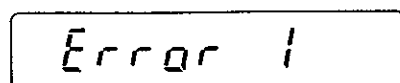

If an unstable condition exists for more than 30 seconds, the balance will not display zero.

“*Error 1*” will be displayed.

- Check the clearance between the draft ring and the pan.

Reset the pan and press the **ON:OFF** key.

- ▶ If “Error 1” is displayed even with the pan properly set, the error may be the result of a poor working environment.

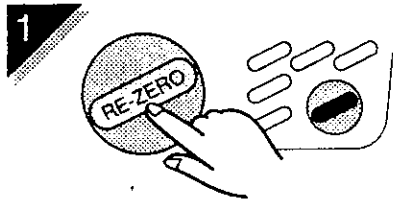

When the **RE-ZERO** key is pressed, a value zero should be displayed. Check the installation conditions on **page A•3**, especially for the draft and vibration.

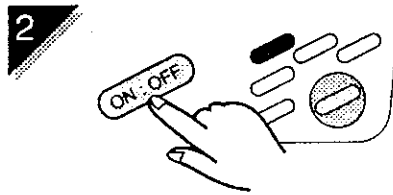

When “Error 1” still appears, press the **ON:OFF** key and then change the C-Parameter setting from “[ond ?co” to “[ond 3 co”. (To change C-Parameter settings, refer to **page E•3** and **E•4**.)
If the error continues, ask for servicing.

 Weighing pan error

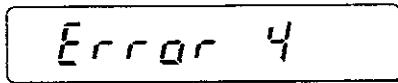

This error occurs when the weighing pan and pan support are not set properly or when the **ON:OFF** key is pressed with something on the weighing pan.

- ▶ Properly assemble the weighing pan and pan support. Remove any objects that may be on the weighing pan.
If the error is still continued, ask for servicing.

 Memory error

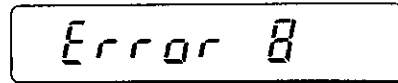
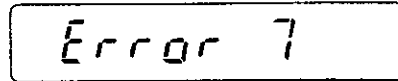
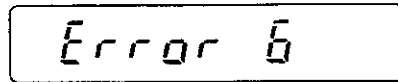
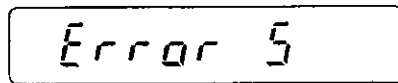

“Error 5” to “Error 8” indicates a balance memory error.

- ▶ Disconnect the AC power. After several seconds, reapply power.
If this error still continues, ask for servicing.

HA SERIES • Section B

Introduction

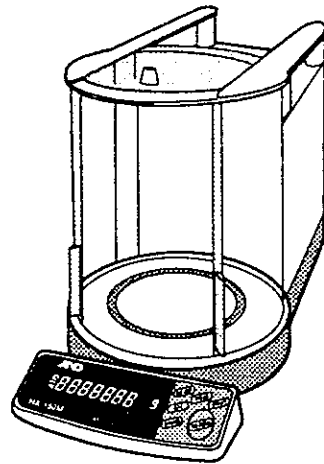



Specifications

	HA180M	HA120M
Gram (g)	180×0.0001g	120×0.0001g
milligram (mg)	180000×0.1mg	120000×0.1mg
Decimal Ounce (oz)	6.3×0.00001oz	4.2×0.00001oz
Troy Ounce (ozt)	5.7×0.00001ozt	3.8×0.00001ozt
Penny weight (dwt)	115×0.0001dwt	77×0.0001dwt
Carat (ct)	900×0.001ct	600×0.001ct
Momme (mm)	48×0.0001mm	32×0.0001mm
Grain Unit (GN)	2,777×0.002GN	1,851×0.002GN
Tola (t)	15×0.00001t	10×0.00001t
Tael (TL)	4×0.00001TL	3×0.00001TL
Display by an arbitrary coefficient factor * [MLt]	1800000×1 (Max.)	1200000×1 (Max.)
Maximum Displayed capacity	180.0009g	120.0009g
Repeatability (standard deviation)	0.0001g	
Linearity	±0.0002g	
Stabilization time	4 seconds (typically)	
Sensitivity drift	±2ppm/°C (10°C ~ 30°C)	
Operating environment	5° ~ 40°C, 41° ~ 104°F, RH<85%	
Display update	4 per sec. (when data stable), 8 per sec. (when data unstable)	
Pan size	φ90mm (φ3.5 inch)	
Chamber dimensions	φ178×212 (H) mm	
Balance dimensions	204 (W)×465 (D)×265 (H) mm	
Power	100, 120, 220, 240VAC as required, (factory preset) 50/60Hz	
Net weight (approx.)	10.5kg/23lb	

- * Display by an arbitrary coefficient.
The value when the gram value is multiplied by an arbitrary coefficient is displayed.
For details, refer to **page B-12**.

Dimensional Outline Drawing

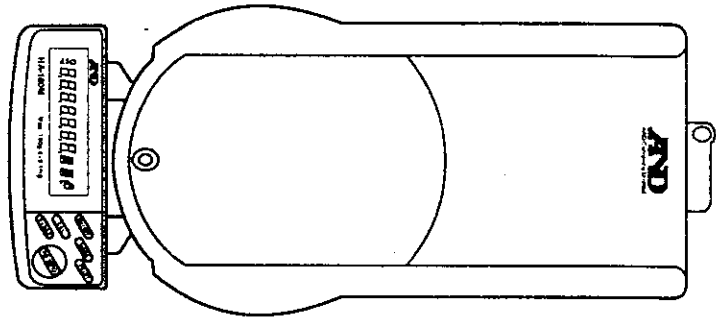

TOP VIEW

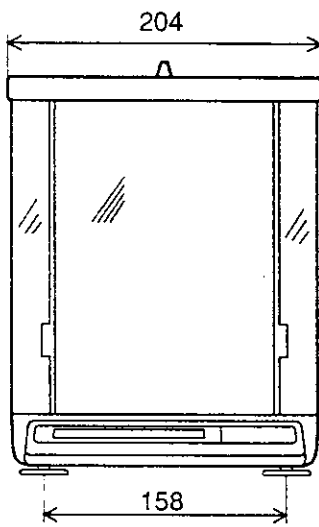

FRONT VIEW

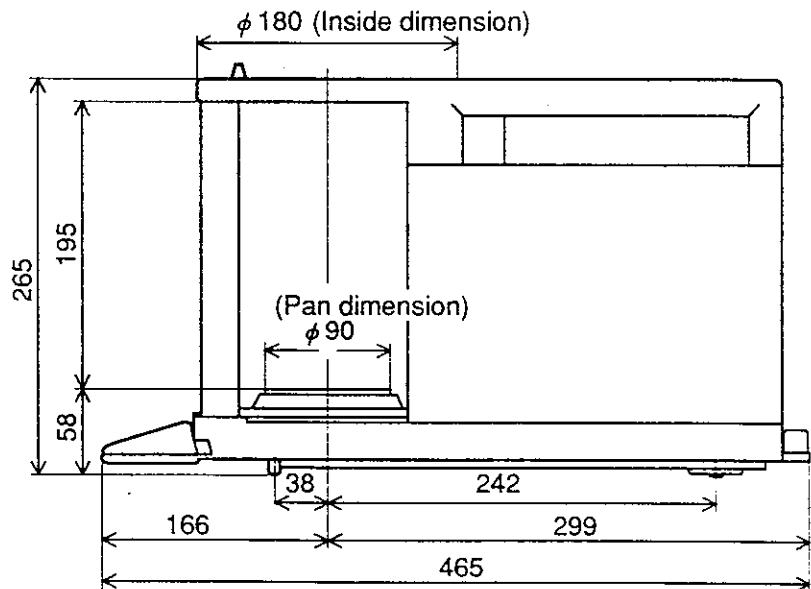

SIDE VIEW



Features

- This electronic balance has an automatic self-calibration function. With this function, as soon as a change in ambient temperature is sensed, calibration is automatically performed using built-in calibration weights. (Sensitivity drift and linearity are also calibrated.)
- A dedicated range key easily enables speedy measurement according to the required measuring accuracy.
- The cylindrical chamber enables front measurement, providing easier operation than with conventional types.
- Weighing units can be grams 'g', milligrams 'mg', decimal ounces 'oz' (avoir), troy ounces 'ozt', penny weights 'dwt', carats 'ct', mommes 'mm', grain units 'GN', tolas 't', and tals 'TL'. 'MLt' is displayed when the gram value is multiplied an arbitrary coefficient.
- An input jack on the rear of the balance enables external re-zero control, external command, or a vibratory spoon (option).
- An underhook weighing fitting for easy measurement of specific gravity is provided as a standard equipment.



Options

- OP-03 (Option)**
This serial interface (bidirectional RS-232C and current loop) can be installed by the user.
- Vibratory Spoon AD-1651 (Option)**
This spoon is used for extraction and mixing of small amounts of leaves and dyes. It uses the frequency resonating method to allow for frequencies from 110Hz to 230Hz. The connection of this spoon to the HA series balances will enable auto measurement.
(The target weight can be set by the front panel key on the balance HA.)
- Compact Printer AD-8117 (Option)**
This thermal serial-dot printer (with statistical operation functions) can print out the weight value, total weight, count, standard deviation, etc.
- OP-11 (Option)**
The OP-11 is a locked anti-theft device which secures a balance on a table to prevent victimization by theft. (The balance table mounting section should have a thickness of 10cm max. and a ϕ 20mm to ϕ 25mm hole.)

Stand-by State

 As long as the AC adaptor is connected, the electronic balance is always in the energized state. This state will not adversely effect the balance. Before using, be sure to energize (warm up) the balance for at least one hour.

○ “**The stand-by state**” indicates a state in which the AC adaptor is connected and the balance display is off.

▶ Use the **ON:OFF** key to turn on and off the display. When the balance is in the stand-by state, the rightmost decimal point should be illuminated.

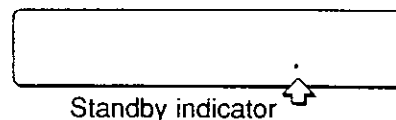

Door Opening/Closing

□ Open the doors properly (to reduce the influence of air flow).

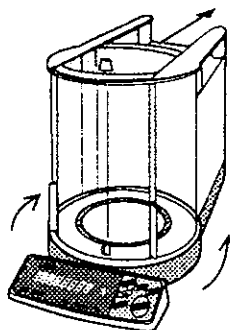

□ Stick on door knobs supplied are convenient in opening and closing the front door.

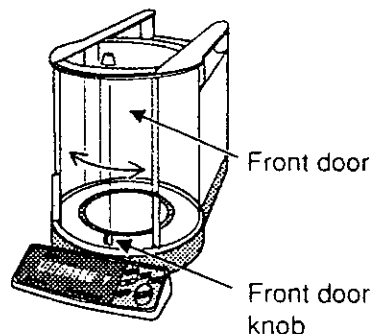

- The fully opened door allows use as a general Roberval balance.

 In this case, use the RANGE (refer to **Page B•9**) to set the max. display to 0.01g.
With the range set to 0.0001g, the balance is easily affected by air flow.

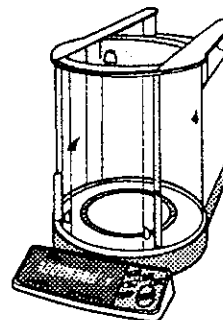

C-Parameter Settings

In HA series, the internal settings of the balance can be changed according to ambient environments and applications.

These settings can freely be changed and stored in the memory, and retained when the AC adaptor is disconnected.

A list of C-Parameter settings and alteration methods are indicated in **pages E•2** and **E•3**, respectively.

For details, refer to “**The C-Parameter Settings**” (on **pages E•4** to **E•13**).

The Display and Keyboard

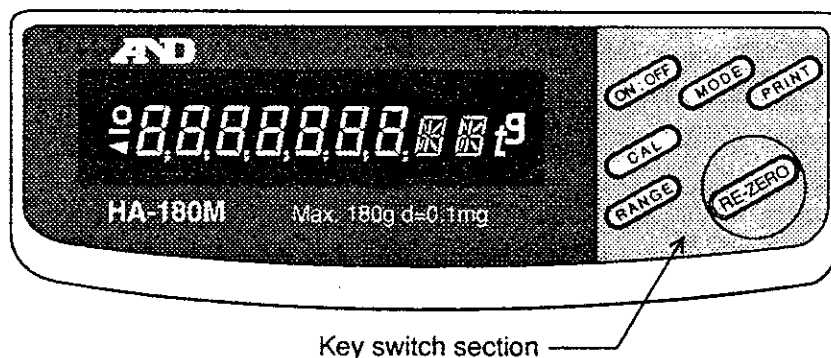

 Press the center of each key switch firmly. When the key switch is pressed, a “beep” sound is emitted.

(Do not use a pointed object such as a pen.)

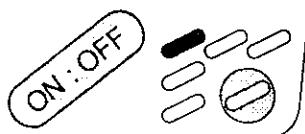

ON : OFF key

- The **ON:OFF** key turns on and off the display. Irrespective of operating **ON:OFF** key, the balance is in the energized state, if the AC adaptor is connected.
- When the display is set to on, all displays appear. A stability indicator “o”, negative sign “-”, and weight value “0.00000000” are displayed. A single decimal point, to the right of the last digits, indicates that power is connected when the display is off. The three-digit section next to a decimal point indicates the unit.

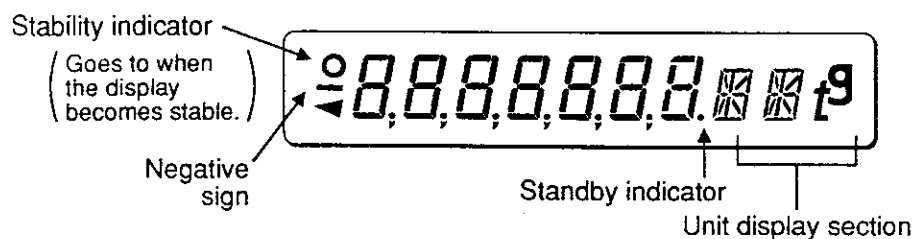

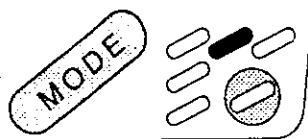

MODE key

- When the **MODE** key is pressed, the display mode is changed.
- Weighing units can be grams 'g', milligrams 'mg', decimal ounces 'oz' (avoir), troy ounces 'ozt', penny weights 'dwt', carats 'ct', mommes 'mm', grain units 'GN', tolas 't', and taelis 'TL'. (Refer to "Weighing Units and Their Conversions" on page B-14 for more information concerning the different weighing units.) The 'MLt' when the gram value is multiplied by an arbitrary coefficient can also be displayed. (For details, refer to page B-12.)
- The display mode is changed in the following order:

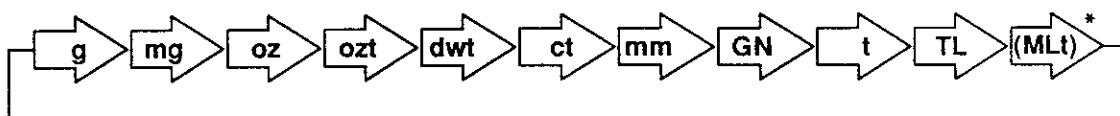

* In the MLt mode, no display is made on the unit section during weighing.
Coefficient is 1 at shipment time.

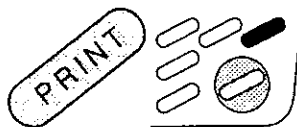

PRINT key

- When the balance is connected to a printer or computer, the **PRINT** key is used to transfer data. In this case, the serial interface OP-03 (option) is also needed. (Refer to Page F-1.)

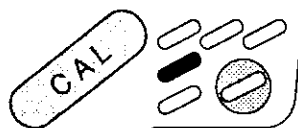

CAL key

- When the **CAL** key is pressed, calibration is performed. After warming up the balance sufficiently, make sure that nothing is on the pan and press the **CAL** key. A calibration weight is automatically applied to the balance mechanism, and then removed. (Refer to "Calibration" on page C-1.)
- To make precise measurements, calibration should be made at least once a day.
- When the operating temperature changes, the auto self-calibration function (on page C-3) is activated to perform full-auto calibration without touching the key.



RANGE key

- When the **RANGE** key is pressed, the min. display is changed (the max. balancing amount remains unchanged).
- When the unit is a gram



When the unit is a milligram

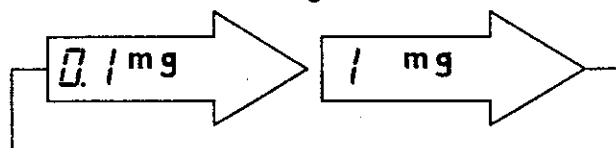

When the unit is a carat

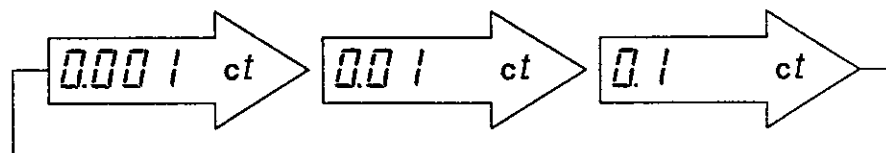

- Reducing the digits displayed by the **RANGE** key will reduce the time required to stabilize the balance. This facilitates faster measurement.
- When used with the door fully opened, set the display to a minimum range (for example: '001 g').

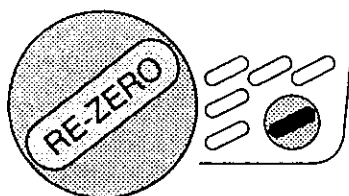

RE-ZERO key

- When the **RE-ZERO** key is pressed, the display is set to zero.
The taring operation can be performed up to the max. balancing amount.
- If the display is off from zero, press the **RE-ZERO** key to set the display to zero.

Selecting Weighing Units

! The HA series balances are multi-functional instruments where switching between the weighing units contained in the balance software is done by pressing the **MODE** key. You may use all of the units, or at this software level *you can disable the weighing units you don't regularly use*. Also, some dealers may initially turn OFF units which are not regular used, but you may want to turn them back ON. The complete weighing mode cycle is as follows (if some are missing please refer to your dealer):

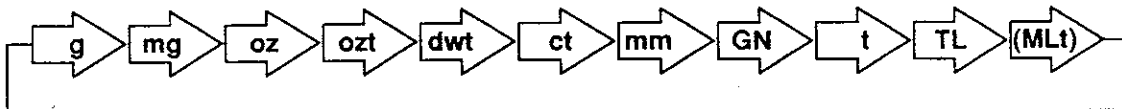

To Turn Weighing Units OFF or ON

! To return to the normal mode during operation, press the **ON:OFF** key.

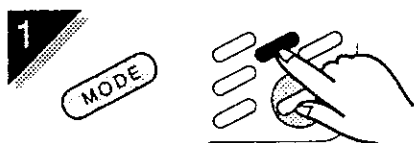

▶ After setting the display to off, press and hold the **MODE** key.

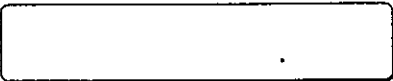
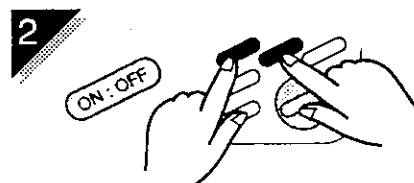
▶ With the **MODE** key held down, press the **ON:OFF** key.

○ “**Unit g**” is displayed.

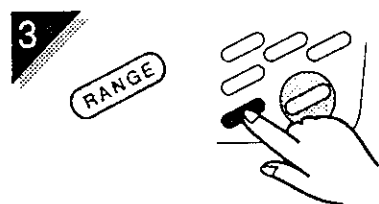
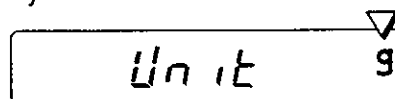

▶ When storing a gram “g” value, press the **RANGE** key.

○ A stability indicator “**o**” goes on.

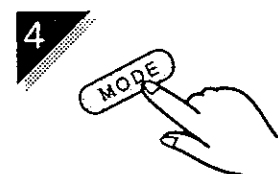
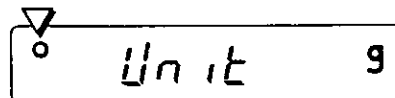

▶ Press the **MODE** key to move the next unit.

○ “**Unit mg**” is displayed.

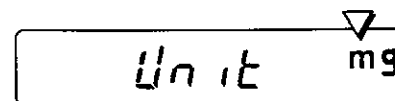



- ▶ When storing a milligram “mg” value, press the **RANGE** key.

- A stability indicator “o” goes on.

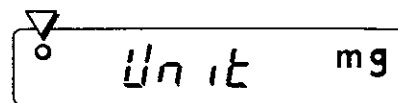

- ▶ When “mg” is not chosen to be stored, press the **MODE** key to move the next unit “Unit oz”.

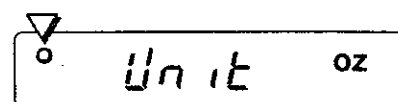

- 6** Similarly, press the **MODE** key and **RANGE** keys to set the unit.

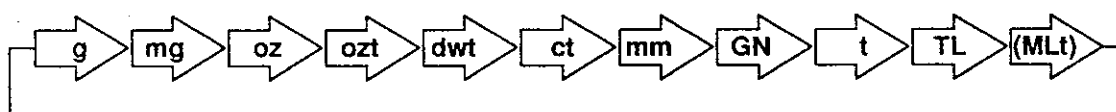

- Weighing units can be grams ‘g’, milligrams ‘mg’, decimal ounces ‘oz’ (avoir), troy ounces ‘ozt’, penny weights ‘dwt’, carats ‘ct’, mommes ‘mm’, grain units ‘GN’, tolas ‘t’, and tael’s ‘TL’.

In the ‘MLt’ mode, the value when the gram value is multiplied by an arbitrary coefficient is displayed. (‘MLt’ does not appear on the display during weighing. For setting and checking arbitrary coefficient, refer to page B-12.)



- ▶ After the completion of setting the necessary units, press the **PRINT** key. The units are stored and the balance returns to the measurement mode.



- ▶ To abort this sequence, press the **ON:OFF** key. The display returns to off.

☞ Setting and Checking Arbitrary Coefficient (MLt Unit Mode)

- In the multi-unit mode 'MLt', the value displayed is the gram value is multiplied by an arbitrary coefficient. (Example: In 'MLt' mode, at a coefficient of 0.5, "50.0000" is displayed when a 100g weight is placed on the balance.)
- During weighing in the multi-unit, no display is made on the unit section.
- The coefficient is "1" at shipment time. (A numerical value the same as that in gram is displayed.)
- The coefficient can be set and checked by the keys on the front panel and RS-232C (option).

The following is an example of setting and checking the coefficient by the keys on the front panel.

! To return to the normal mode during operation, press the **ON:OFF** key.

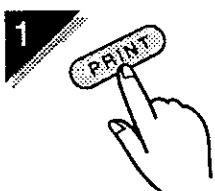

- With the display OFF, press and hold the **PRINT** key.

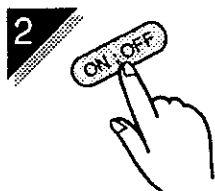

- With the **PRINT** key held down, press the **ON:OFF** key.



- The value previously set is displayed. (Coefficient = "1" in the example)
- When checking the coefficient only, press the **PRINT** key to return to the normal.



- Press the **MODE** key. The display on the left end is changed to "0" and blinks.

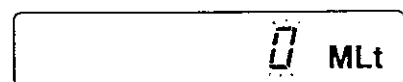

- A coefficient of up to 7 digits, with the positive polarity only, can be entered. The input range for the coefficient is:
"0.000000 ~ 10000.00"
- The coefficient will be set to "25.00000" in subsequent examples.

4

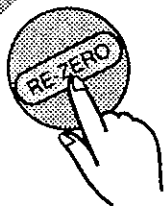

- ▶ Press the **RE-ZERO** key twice to set "2".



5



- ▶ Press the **MODE** key to move to the next digit.

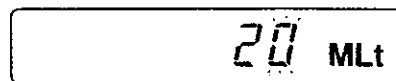

- ▶ Thereafter, set the numerical value by the **RE-ZERO** and **MODE** keys. Use the **RANGE** key to enter a decimal point.

6



- ▶ After entering the necessary numerical values, press the **PRINT** key.

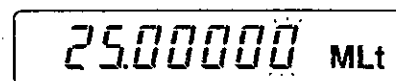

- After the set values were stored, the unit is returned to the weigh mode.

(This example shows that when the unit is set to the "MLt" mode after returning to the weigh mode, "2500.00" is displayed with a 100g weight placed on the balance.)



To set and check the coefficient using the RS-232C (option), proceed as follows: (Refer to **pages F-14 to F-16.**)

- ▶ **Confirming the set value** (by RS-232C)

?	M	L	crj
---	---	---	-----

 { A personal computer requests the balance to send the currently set coefficient.

Example of response

M	L	,	+	2	5	.	0	0	0	0	0	crj
---	---	---	---	---	---	---	---	---	---	---	---	-----

(25.00000 set)

- ▶ **Changing the set value** (by RS-232C)

Example)

M	L	3	.	0	crj
---	---	---	---	---	-----

(This example shows that 3.0 is newly set. The input range of coefficient is 0.000000 to 10000.00 .)

Weighing Units and Their Conversions

Abbrev.	Name in full	Conversion
mg	Milligram	0.0001g
oz	Ounce (Avoir)	28.3495231g
ozt	Troy Ounce	31.1034768g
dwt	Penny weight	1.55517384g
ct	Metric Carat	0.2g
mm	Momme (Japan)	3.75g
GN	Grain (UK)	0.06479891g
t	Tola (India)	11.6638038g
TL	Tael (HK, general)	37.7994g
TL	Tael (HK, jewellery)	37.492g
TL	Tael (China)	31.25g
TL	Tael (Sing.)	37.793g
TL	Tael (Taiwan)	37.5g

HA SERIES • Section C

Calibration

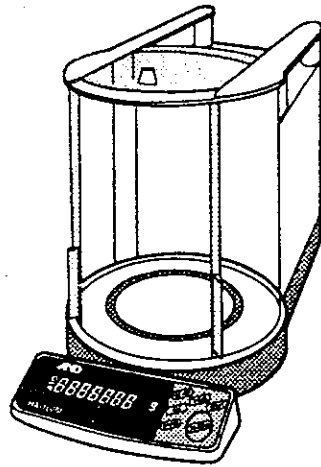



Calibration



A high-precision electronic force balance like the HA series is generally affected by the installation conditions (longitude and altitude) and ambient environmental conditions (temperature, humidity, atmospheric pressure) and may cause errors in the value measured.

HA series balances can be calibrated using the built-in or external reference weight.

There are three calibration methods as indicated below:

Auto Self-calibration

Balances of the HA series always monitor the ambient temperature. As soon as the balance detects a change in ambient temperature, calibration is automatically performed using the built-in weight. (In this case, the sensitivity and linearity of the balance are calibrated.)



At calibration start, the unit display section blinks. After about 2 minutes, calibration is automatically started.

Usually, the balance is kept in the calibrated state due to this auto self-calibration feature.

Auto Calibration

After making sure that nothing is on the pan, when the **CAL** key is pressed, the balance is calibrated by means of the built-in weight. (In this case, the sensitivity and linearity of the balance are calibrated.)



When changing the installation conditions of the balance, calibration can be performed at any time with one touch of a button.

Manual Calibration

This calibration can be performed with the user's weight. (In this case, only the sensitivity of the balance is calibrated.)

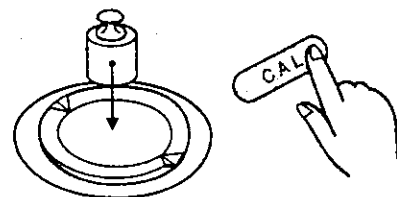

During operation, special care should be given for the vibration and air flow.

Auto Self-calibration

 Balance of the HA series detects a change in ambient temperature by itself and uses a built-in weight to perform auto self-calibration. This function can be inhibited through the “C-Parameter Setting C2” “[RL C2]” (refer to pages E-3 and E-7).

 With power applied, the auto self-calibration function is active, even when in the display-off state; calibration is performed automatically. (In this case, the power indicator blinks to inform of a change in ambient temperature.)



1  When the balance detects the change in outside temperature, the measuring unit blinks for about 2 minutes (example: **g**). During this period, remove any object that may be on the pan.



2  When the display “[RL” appears, calibration is started automatically.

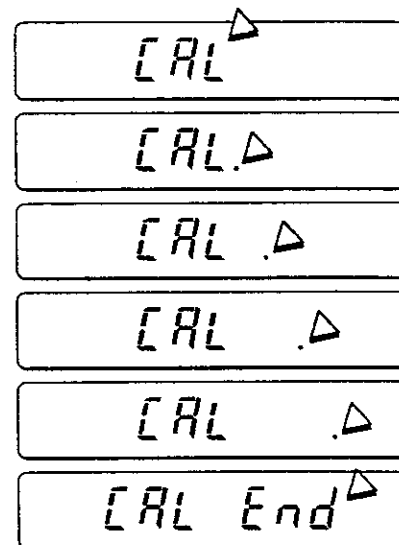

3  After the completion of calibration, the balance returns to the normal weighing mode.

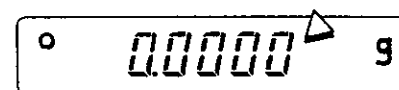

Auto Calibration

1 If the balance has been on for one hour or more, remove all objects measured from the pan.

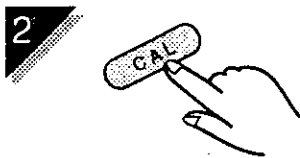

▶ Press the  key.

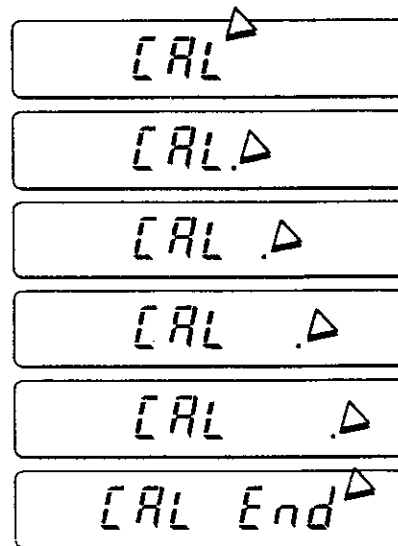

3 After the completion of calibration, the balance returns to the normal weighing mode.

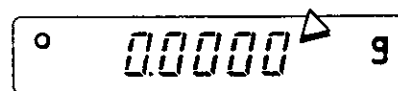

Auto Calibration Check

It is possible to automatically check if calibration has been performed correctly through the C-Parameter setting “[CAL] - [C2]” (“Auto Check after Auto Calibration”) (refer to pages E-3 and E-7).

After the auto check, the error in calibration is displayed (in gram).

When the  key is pressed, the unit is returned to the original state and the zero is displayed.

Before shipping the balance, the C-Parameter setting should be set to “[CAL] - [C2]” “No Auto Check”.

Manual Calibration



! Calibration is performed with the user's weight.
 Weights of 100g and 150g can be used for HA180M and 50g and 100g for the HA120M, each of which required a compensation of $\pm 15.0\text{mg}$.

1 If the balance has been on for one hour or more, remove all objects measured from the pan.

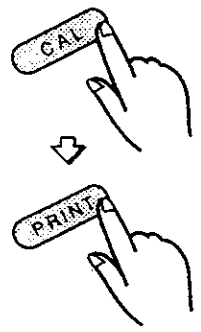
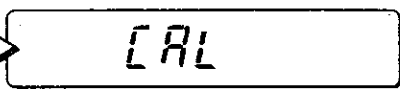

2 With the **CAL** key held down, press the **PRINT** key.

The value of the calibration weight used is displayed (150.0000g for HA180M at shipment). To change the weight value setting, refer to the next page.



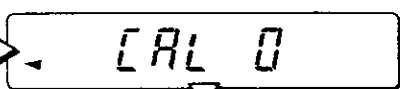
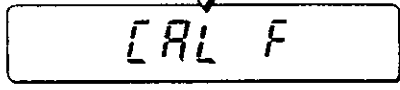

3 Press the **RE-ZERO** key.

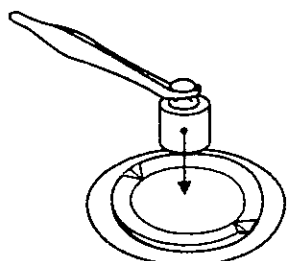
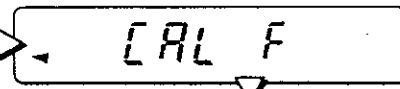
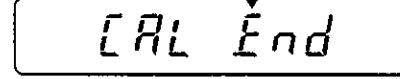

4 When "[CAL F" is displayed, put a calibration weight on the pan.

"[CAL End" is then displayed.

5 Remove a weight.

The balance returns to the normal weighing mode.

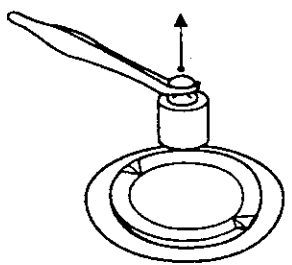
Changing the Set Value of a Calibration Weight



To change the set value of a calibration weight, perform the following operations between steps and on the previous page.

HA180M : 100g 150g ±0.0150g

HA120M : 50g 100g ±0.0150g

▶ When the **RANGE** key is pressed, the value is changed 50g for 50g.

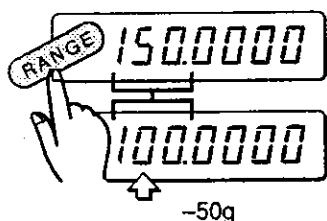

▶ When the **MODE** key is pressed, the value is changed 0.0010g for 0.0010g.

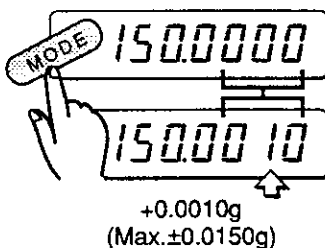

▶ When the **PRINT** key is pressed, the value is changed 0.0001g for 0.0001g.

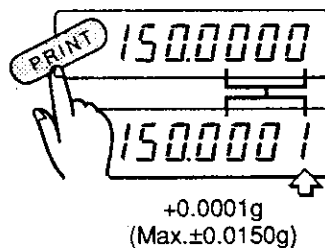

Calibration Notes and Errors

! When two calibration weights appear (for example, 100g and 50g instead of 150g), “-CAL E” may be displayed, but this is not an error.

Error display

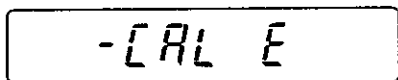

“-CAL E” is displayed when a calibration weight is too light.

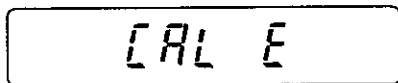

“CAL E” is displayed when a calibration weight is too heavy.

▶ Make sure that all measured objects are removed, the weighing pan is set properly, and the value of a weight is set correctly, and then press the **RE-ZERO** key.

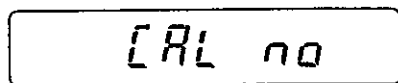

“CAL no” is displayed when calibration cannot be performed since the balance is unstable due to factors such as vibration and air flow.

▶ After checking for vibration and air flow, press the **RE-ZERO** key. Refer to “Best Conditions For Weighing” on page A-3.

HA SERIES • Section D

Weighing Mode

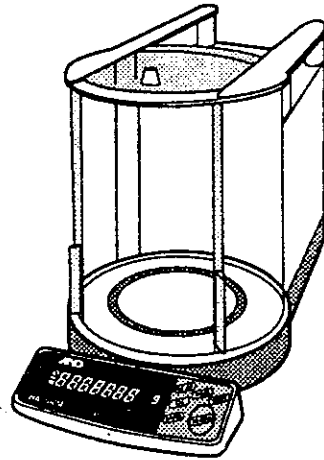

Wimple Weighing

 To make accurate measurements, be sure to warm up the balance for one hour or more, refer to “Best Conditions For Weighing” (on page A-3).

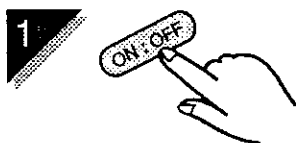

- ▶ Press the **ON/OFF** key.
- All displays go on.
- Display blanks until the stable state is obtained.
- Zero and stability indicator should be displayed.

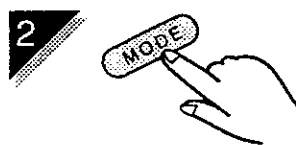
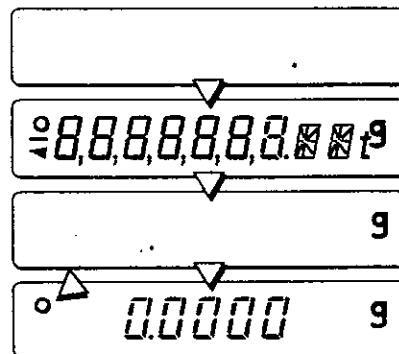

- Press the **MODE** key to select the unit, as needed.

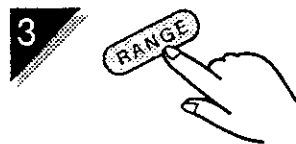
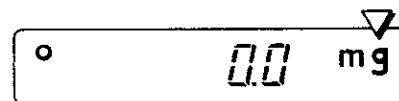

- To change the min. display, press the **RANGE** key. (Refer to “RANGE key” on page B-9.)

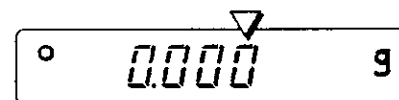

- 4** ▶ Open the door.

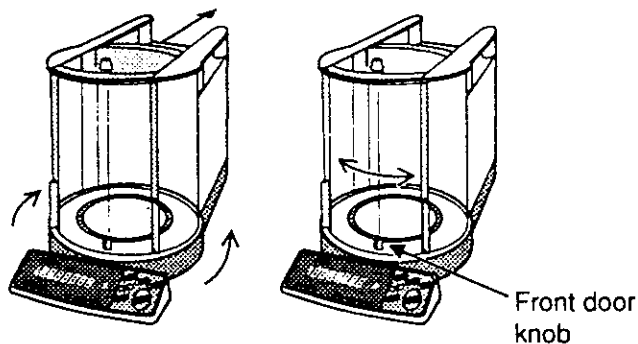

- 5** ▶ Place the object to be measured on the pan.

- ▶ Close the door and read the measured value after the stability indicator is displayed.

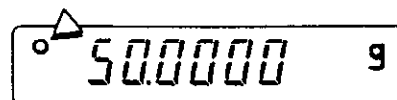
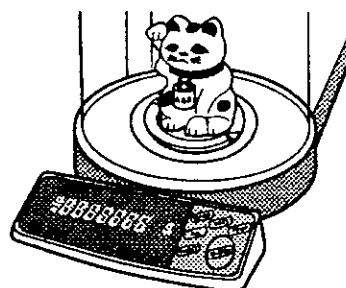

Weighing Error

Weighing pan error

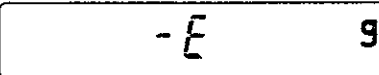

- “-E” appears when the weighing pan, pan support, or balance weight is missing.
- ▶ When an error continues, even after the weighing pan or pan support is properly assembled, ask for servicing.

Overload error

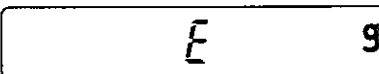

- “E” appears when the weight of a measured object exceeds the balancing capacity.
- ▶ When an error continues, even after the measured object is removed, ask for servicing.

Internal operation error

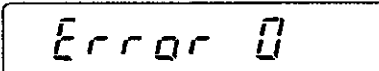

- “Error 0” indicates that an error occurs during internal operations of the balance.
- ▶ Ask for servicing.

Error indicating unstable state

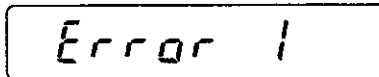



- “Error 1” indicates that no zero can be displayed because the balance was unstable during re-zero operation.
- ▶ After checking for vibration and air flow, press the **RE-ZERO** key. Refer to “Trouble” on page I-2.

Memory error









- “Error 5” to “Error 8” indicates a balance memory error.
- ▶ Disconnect the AC adaptor and connect it with power. If this error still continues, ask for servicing.

Using RE-ZERO to Tare

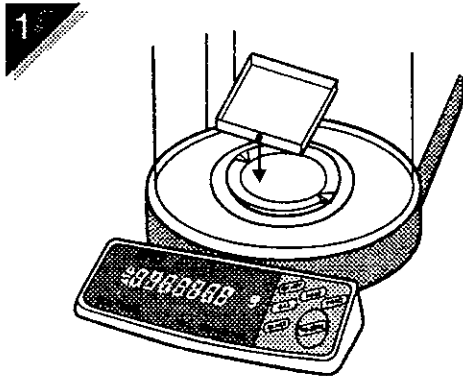

- ▶ Put a container on the weighing pan.



- The weight of the container is displayed.

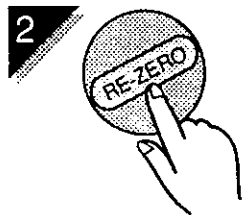

- ▶ Press the **RE-ZERO** key to tare the containers weight.
- Zero is displayed.

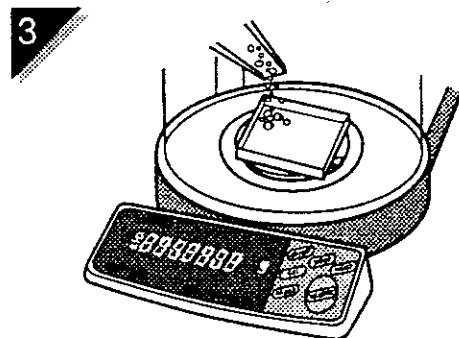

- ▶ Add samples until the target weight is obtained. Each time another sample is measured, press the **RE-ZERO** key prior to measurement.

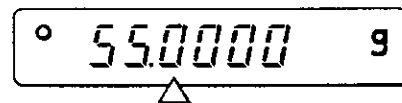

- The weight of sample is displayed. To escape from this measurement, press the **ON:OFF** key.



Making More Precise Weighing



To make full use of the HA series balance performance for more precise measurements, care should be given to the following items:

- Selection of the installation site and ambient environment of the balance. Refer to the “**Best Conditions For Weighing**” (on page A-3). To make stable and precise measurements, be sure to warm up the balance 4 hours or more before using.
- Swiftly perform the measuring operation with care. Taking time for measurement will increase the risk of error due to changes in temperature and humidity in the measuring room, fluctuation in air, reaction of sample, and humidity absorption.
- The static electricity may cause errors in the measurement. When the ambient humidity drops below 45%, an insulating material such as plastic can easily be charged with static electricity. Increase the relative humidity or place the sample in a conductive container for measurement.
- The influence of magnetism may cause an error. When measuring the magnetic substance (such as iron), use the underhook method of measurement, keeping the balance body away from the sample. (Refer to page D-7).
- The measurement results may include an error caused by air buoyancy. Air buoyancy varies with the volume of sample, atmospheric pressure, temperature, and humidity. Compensate for the buoyancy for precise measurement. For details, contact A&D.

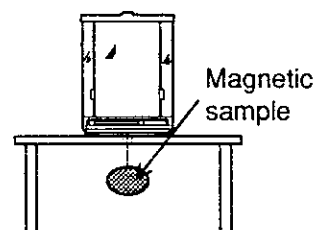
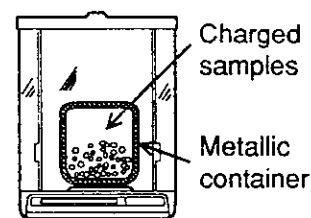

Re-zero/Print Operation via External Input Terminal

 The “re-zero” or “print” operation can externally be performed by using the EXT. switch (external input terminal) on the rear of the main body. This terminal is also used to connect the balance and “**Vibratory Spoon AD-1651**” (option) (refer to **page G-1**). Either one of these three functions of the EXT switch is selected according to the internal setting of the balance (refer to **page E-1**).

The following are the methods in performing “re-zero” or “print” operation:

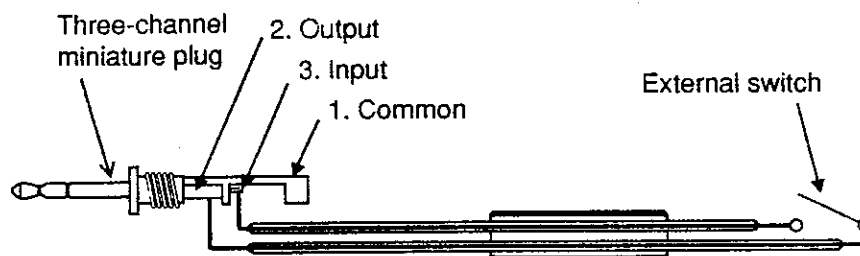

- ▶ Connect the switch between 2 (output) and 3 (input) of the three channel miniature plug (accessory). The short circuit between 2 and 3 will serve for the same operation as the key (**RE-ZERO**) or (**PRINT**) pressed on the panel.
- ▶ Select the (**RE-ZERO**) or (**PRINT**) function according to internal setting “**Cont c4**” of the balance (refer to **page E-3** and **E-9**).

C4 Restriction of Setting and Others

<input type="checkbox"/> Cont	? C4	Selection of external input terminal function	
Cont	0	RE-ZERO function	FC40:0
	1	PRINT function	FC40:1
	2	Vibratory spoon control function	FC40:2



Underhook Weighing



The HA series balance has an underhook weighing fitting as standard equipment. The underhook weighing is the method used for measuring the specific gravity and the weight of a magnetic substance.

- ① When the cap on the bottom of the main body is removed, the underhook weighing fitting can be seen.
- ② Set the balance on a rigid table.
- ③ As shown in the figure to the right, put a thread through the fitting and suspend a weighing pan.
- ④ Care should be taken to prevent the air from flowing around the balance.

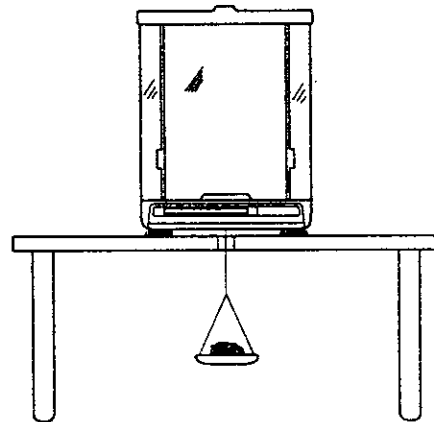
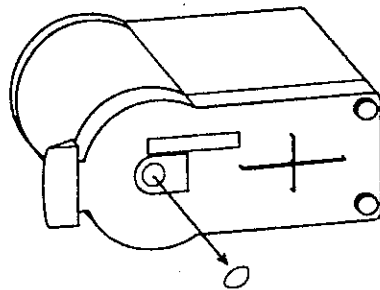

The specific gravity of metal can be measured by the reduction of weight in water. This is based on the fact that 1g of water is almost 1cm³ (refer to "Reference" on the **next page**).

Specific gravity (g/cm³) can be calculated by dividing (Weight in air) by (Reduction of weight in water).



Underhook Weighing Example

1

- ▶ After preparing for underhook weighing, press the **RE-ZERO** key to set the balance weight to zero.

○ Zero is displayed.

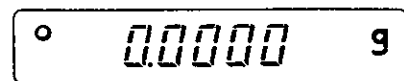

2

- ▶ Put a sample on the pan and record the value.
- In this example, weight in air should be 10g.

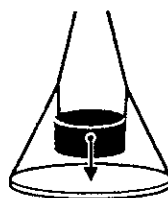

10.0000 g

3

- ▶ After removing the sample to put the pan in the water, press the **RE-ZERO** key to set the display to zero.



0.0000 g

4

- ▶ Put a sample in 4°C water.
- In this sample, the balance weight is displayed as -0.4662g, which almost corresponds to 0.4662cm³.

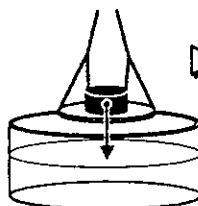

-0.4662 g

5

- ▶ Calculation: $\frac{10.0000\text{g}}{0.4662\text{cm}^3} \approx 21.45\text{g/cm}^3$

The above value shows that this sample may be platinum.

[Reference]	
Density of water (g/cm ³)	
0°C	0.99984 g/cm ³
4°C	0.99997
10°C	0.99970
15°C	0.99910
20°C	0.99821
25°C	0.99705
30°C	0.99565

HA SERIES • Section E

Internal C-Parameter
Settings

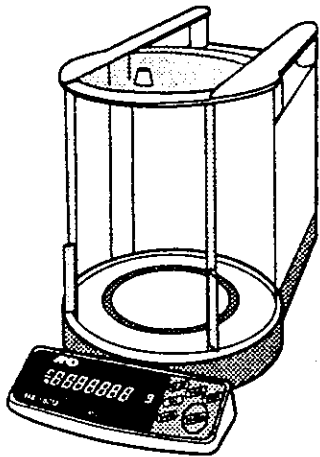

Internal C-Parameter Settings

! A balance of the HA series has various internal settings that are used to modify response characteristics, display update rate and data output format, match it to the working environment and various peripheral equipment.

These set values can freely be changed and are stored in the memory, even when the AC adaptor is disconnected. A list of C-Parameter settings are shown below.

To change C-Parameter settings, refer to “**Changing C-Parameter Settings**” (on page E-3), and the detailed explanation of each C-Parameter setting is given in “**The C-Parameter Settings C0 to C6**” (on pages E-4 to E-13).

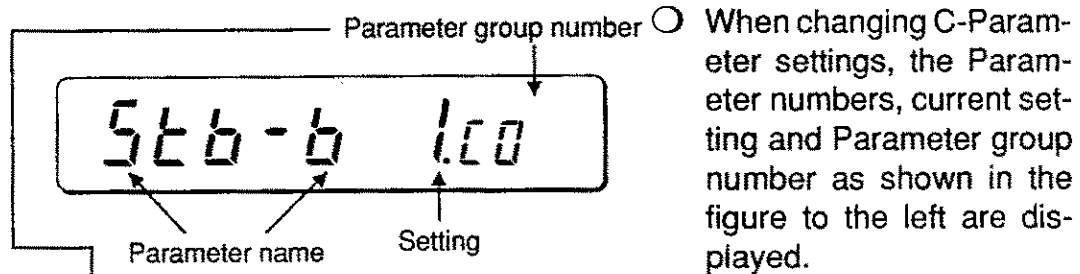

C0 Environment	5t6-b Stable detection width	Cand Response characteristics	trc Zero tracking			
C1 Display	SPEED Display re-writing speed	Point Decimal point	P-on Auto start			
C2 Calibration	CAL CAL select	CAL-C Auto check				
C3 Auto re-zero	Ar-0 Auto re-zero	Ar-b Auto re-zero width	Ar-t Detecting time			
C4 Setting restriction and others	Cont External input terminal	bEEP Alarm	PF Restriction of setting change			
C5 Data output	Print Mode select	AP-P Auto print polarity	AP-b Auto print width	CODE Data No.	PAUSE Data output pause	At-F Auto feed
	Ar-d Re-zero after output					
C6 Serial interface	bPS Baud rate	PAR Parity	bit Bits per character	StopP Stop bit	Cr-LF Terminator	tYPE Data format
	t-UP Time-out	dP Decimal point code	E-Cod Error code	CtS CTS control		

Not displayed without serial interface OP-03 (option).

Changing C-Parameter Settings

- ❗ When a change is restricted by the setting "PF C4" (on page E-9), the C-Parameter setting cannot be changed.
If a change of settings, "PF [C4", to "PF [C4".
- If the **ON:OFF** key is pressed during this process, the C-Parameter is not changed and the balance is returned to the weighing mode.

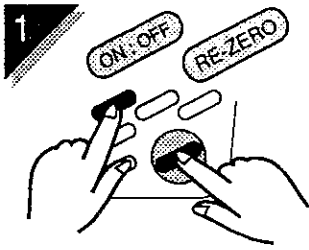

- ▶ After setting the display to off, press the **ON:OFF** key with the **RE-ZERO** key held down.

- All displays should illuminate.

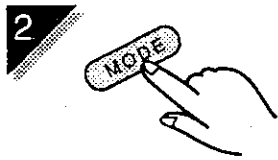

- ▶ When the **MODE** key is pressed, the balance is returned to the C-Parameter setting mode.

- After the program version has been displayed for about one second, the Parameter name, setting, and group number is displayed.

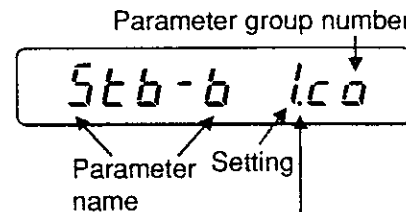

A decimal point indicates that the setting is stored.



- ▶ Use the keys shown in the right figure to change the C-Parameter setting.

- The decimal point of the current set value internally stored should illuminate..
- The Parameter name, Setting, and Group number are displayed in sequence. Continuously pressing the key will return the display to the original location, if the correct location was skipped.

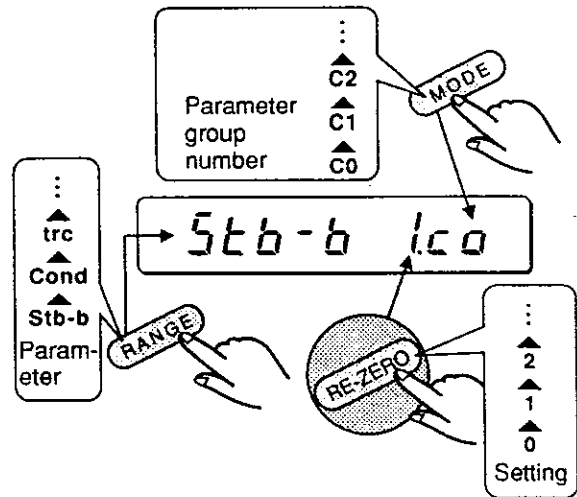

- ▶ After the completion of the above steps, press the **PRINT** key. The new setting is internally stored and the balance will return to the weighing mode.

The C-Parameter Settings (C0 to C6)

Parameter abbreviation (Displayed as follows)	Parameter group number	Parameter name
↓	↓	↓
<input type="checkbox"/> Stb-b	? C0	Stability band width
"." indicates the factory preset setting.	0 .	±1 digit
	1	±2 digits
		FC00:0
		FC00:1
↑	↑	↑
Parameter setting	Parameter setting definition	FC No. at RS-232C (with OP-03 equipped)

C0 Environment

<input type="checkbox"/> Stb-b	? C0	Stability band width
		○ When the display change is within the width set by "Stb-b" for about one second, the stability indicator goes on.
Stb-b	0 .	±1 digit
	1	±2 digits
	2	±3 digits
		FC00:0
		FC00:1
		FC00:2

* The minimum change of a figure displayed is called one digit.
 For example, when the **[RANGE]** key is pressed to display 0.1 mg, one digit is 0.1mg. Similarly, when 1mg is displayed, one digit is 1mg.
 (For the **[RANGE]** key, refer to **page B-9.**)

<input type="checkbox"/> Cond	? C0	Response characteristics/Environment
		("Cond 0", is suitable for scaling.)
Cond	0	Very quick response/Very good environment
	1	Quick response/Good environment
	2 .	Normal response/Normal environment
	3	Slightly slow response/Slightly poor environment
		FC01:0
		FC01:1
		FC01:2
		FC01:3

<input type="checkbox"/> trc	? C0	<p>Zero tracking detection time</p> <p><input type="radio"/> Zero tracking is a function which detects a small change in the zero point to keep the zero point stable. The possible factors of zero point change include ambient temperature, humidity, and atmospheric pressure. The speed of zero change under the influence of these factors is very slow. When a change within a certain period is below one digit, the HA balance series performs zero tracking to select the zero tracking time. As the set value increases, the zero tracking time becomes shorter and the effect of zero tracking becomes greater. When measuring a very light substance, use a small set value. A small change, starting with zero may be absorbed by zero. For a substance that is not equalized or when measuring a small change with the display set to zero, turn off the zero tracking function.</p>
-------------------------------------	------	---

trc

0	Zero tracking OFF	FC02:0
1	Zero tracking ... long/Effect ... weak	FC02:1
2	Normal/Normal	FC02:2
3	Short/Strong	FC02:3

C1 Display

<input type="checkbox"/> SPEED ? C1	Display update speed
--	----------------------

SPEED

0	Normal speed in stable state, high speed only in unstable state	FC10:0
1	Normal speed (4 times/sec)	FC10:1
2	Always high speed (8 times/sec)	FC10:2

<input type="checkbox"/> Point ? C1	Display of decimal point
--	--------------------------

Point

0	Point (.)	FC11:0
1	Comma (,)	FC11:1

<input type="checkbox"/> P-on ? C1	Auto start function
---	---------------------

P-on

0	Auto start is not performed.	FC12:0
1	Auto start is not performed. It not necessary to press the (ON : OFF) key at measurement start up. Upon turning the power on, the measurement is automatically started. This function is available to incorporate into the automatic machine.	FC12:1

C2 Calibration

<input type="checkbox"/> CAL	? C2	Calibration selection	
CAL	0	Auto calibration enabled (Refer to page C-2.)	FC20:0
	1	Only auto self-calibration disabled (When the ambient temperature changes, a part of unit) "Δ" blinks.	FC20:1
	2	Only auto self-calibration disabled No warning is given even if the ambient temperature changes.	FC20:2
	3	All calibration disabled	FC20:3

<input type="checkbox"/> CAL-C	? C2	Auto check after auto calibration	
CAL-C	0	No auto check is made after auto calibration.	FC21:0
	1	Auto check is made after auto calibration. (Auto check is not activated for auto self-calibration or manual calibration.)	FC21:1

C3 Auto Re-zero

<input type="checkbox"/> Ar-0	? C3	Auto re-zero function near zero	
Ar-0	0	Auto re-zeroing is not performed.	FC30:0
	1	Auto re-zeroing is performed. (The re-zero operation is automatically performed when the measured value is continued in fixed widths (selected by "Ar-b") near zero at a fixed time (selected by "Ar-t").)	FC30:1

<input type="checkbox"/> Ar-b	? C3	Selection of size determined to be near zero	
Ar-b	0	±5 digits	FC31:0
	1	±50 digits	FC31:1
	2	±500 digits	FC31:2

<input type="checkbox"/> Ar-t	? C3	Detecting time for near zero	
Ar-t	0	0.5 sec.	FC32:0
	1	1 sec.	FC32:1
	2	2 sec.	FC32:2
	3	4 sec.	FC32:3

C4 Restriction of Setting and Others

<input type="checkbox"/> Cont	? C4	Selection of external input terminal function	
Cont	0	RE-ZERO function (Refer to page D-6.)	FC40:0
	1	PRINT function (Refer to page D-6.)	FC40:1
	2	Vibratory spoon control function (Refer to page G-2.)	FC40:2

<input type="checkbox"/> Ar-b	? C3	Keyboard Beep	
BEEP	0	Off	FC31:0
	1	On	FC31:1

<input type="checkbox"/> PF	? C4	Protect the set parameters ○ Changing the internal setting can be restricted. When "Change not allowed (restricted)" is set, the internal setting cannot be changed unless the setting is changed to "Change allowed".	
PF	0	Internal setting can be changed.	FC42:0
	1	No internal setting can be changed. (Prohibited)	FC42:1

C5 Data Output

Settings in C5 are used for HA series balances with the OP-03 serial interface installed. For details, refer to **pages F-1 to F-24**.

<input type="checkbox"/> Print	? C5	Data output mode selection	
Print	0	Key A mode: The PRINT key is acknowledged only when the display is stable. One data stream is output.	FC50:0
	1	Key B mode: the PRINT key is always acceptable. One data is output after the display becomes stable.	FC50:1
	2	Auto print A: One data stream is output when the display becomes stable at the fixed value or a larger shift away from zero. After output, when the displayed value is returned within the auto print width, the next data can be output.	FC50:2
	3	Auto print B: One data stream is output when the display becomes stable at the fixed value or a larger shift (auto print width) away from a displayed value.	FC50:3
	4	Stream mode: Data is automatically output in sequence each time the display is updated.	FC50:4
	5	Command mode: Data is output via a command from an external unit such as a computer. In addition to the data output command, there are many commands which can externally control the balance.	FC50:5

<input type="checkbox"/> AP-P	? C5	Auto print polarity Selects the polarity (+/-) of data which can be output by auto print A/B.	
AP-P	0	Output only when polarity is positive	FC51:0
	1	Auto print A: Output when polarity is positive or negative Auto print B: Output only when polarity is negative	FC51:1

<input type="checkbox"/> AP-b	? C5	Auto print width (Selects the width of data which can be output by auto print A/B.)	
AP-b	0	10 digits	FC52:0
	1	100 digits	FC52:1
	2	1000 digits	FC52:2
	3	10000 digits	FC52:3
	4	100000 digits	FC52:4

<input type="checkbox"/> COde	? C5	Data no. output	
COde	0	Data No. is not output.	FC53:0
	1	Data no. is output. (Output data no. prior to weight data. After one data stream is output, data no. is automatically increased by one.)	FC53:1

<input type="checkbox"/> PAUSE	? C5	Data output pause	
PAUSE	0	There is no data output pause.	FC54:0
	1	There is a data output pause. (With the AD-8117A printer connected, set the value of 'PAUSE' to "1" so that the printer can complete printing.)	FC54:1

<input type="checkbox"/> At-F	? C5	Auto feed function	
At-F	0	Paper is not automatically fed.	FC55:0
	1	Paper is automatically fed. (With the AD-8117A printer connected, 1 sec after data is output, <CR> and <LF> are output to feed paper. In the stream or command mode, this function is not activated.)	FC55:1

<input type="checkbox"/> Ar-d	? C5	Auto re-zero after data output (In key A/B or auto print A/B, selects whether or not to perform an auto re-zero operation after output.)	
Ar-d	0	Auto re-zero is not performed after data output.	FC56:0
	1	Auto re-zero is performed after data output.	FC56:1

C6 Serial Interface

Settings in C6 are used for HA series balances with the serial interface OP-03 installed. For details, refer to pages F-1 to F-24.

<input type="checkbox"/> bPS	? C6	Baud rate	
bPS	0	600 bps	FC60:0
	1	1200 bps	FC60:1
	2	2400 bps [Specified when the AD-8117(A) printer is connected.]	FC60:2
	3	4800 bps	FC60:3
	4	9600 bps	FC60:4

<input type="checkbox"/> PAR	? C6	Parity	
PAR	0	EVEN	FC61:0
	1	ODD (When bits per character is 8 bits, non-parity is automatically specified.)	FC61:1

<input type="checkbox"/> bit	? C6	Bits per character	
bit	0	7 bits (Always attach parity.)	FC62:0
	1	8 bits	FC62:1

<input type="checkbox"/> StoP	? C6	Stop bit	
StoP	0	1 bit	FC63:0
	1	2 bits	FC63:1

<input type="checkbox"/> Cr-LF	? C6	Terminator (Set for sending and receiving.)	
Cr-LF	0	<CR> <LF>	FC64:0
	1	<CR>	FC64:1

<input type="checkbox"/> tYPE	? C6	Data format (Selects the format of weight data to be output. For details, refer to "Weight Data Output Format" on page F-9.)
-------------------------------	------	---

tYPE

0	A&D standard format	FC65:0
1	AD-8117A format	FC65:1
2	KF format	FC65:2

<input type="checkbox"/> t-Up	? C6	Timer when command is received
-------------------------------	------	--------------------------------

t-UP

0	Timer ON	FC66:0
1	Timer OFF	FC66:1

<input type="checkbox"/> dP	? C6	Decimal point code (Selects ASCII code of a decimal point to be output.)
-----------------------------	------	---

dP

0	2EH (Point ".")	FC67:0
1	2CH (Comma ",")	FC67:1

<input type="checkbox"/> E-Cod	? C6	Output of "AK" and error code in command mode
--------------------------------	------	---

E-Cod

0	Not output.	FC68:0
1	Output. (In the command mode, the balance outputs "AK" and an error code.)	FC68:1

<input type="checkbox"/> CtS	? C6	CTS control (Selects CTS control or RTS check.)
------------------------------	------	--

CtS

0	Setting when the balance is connected to a computer or the AD-8117 printer. Usually, this setting is used.	FC69:0
1	In the stream mode, data output is stopped when the RST pin is set to a minus value. (Refer to pages F-3 and F-5.)	FC69:1

HA SERIES • Section F

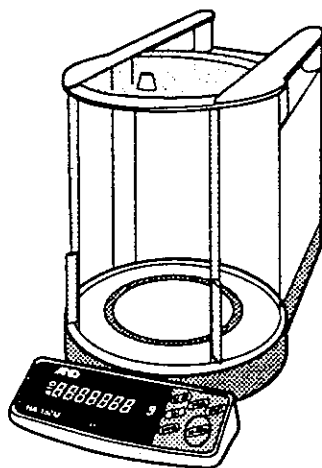

Serial Interface

OP-11 (Option)



* This chapter applies to the HA series balances in which the OP-03 is installed.

OP-03 Installation

- 1  Disconnect the AC adapter from the balance. Remove the setscrews on the rear of the balance.
- 2  Insert the OP-03 board guide into the body of the balance. Make sure that the connector is aligned correctly.
- 3  Attach the OP-03 with the two screws removed in step number one.

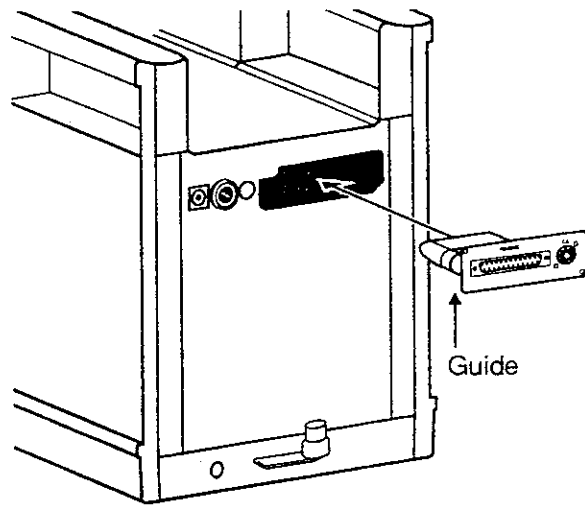

Specifications

Transmission system : EIA RS-232C, 20mA current loop (passive)
 Transmission form : Asynchronous transmission, bidirectional, half-duplex
 Data format : Baud rate : 600, 1200, 2400, 4800, 9600 bps
 Data bits : 7 or 8 bits
 Parity : Even/Odd (bits per character: 7 bits)
 None (bits per character: 8 bits)
 Stop bit : 1 or 2 bits
 Code : ASCII

RS-232C	20mA current loop
1 = -5V ~ -15V	20mA
0 = +5V ~ +15V	0mA

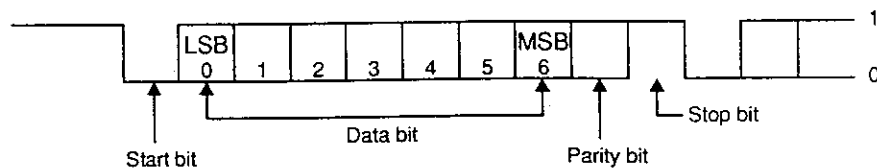

Computer Connection

Cautions on connection

- ① The OP-03 is a DCE (Data Communication Equipment).
- ② The current loop is of a passive type, requiring an external power of 20mA.
- ③ The current loop outputs the same data as that from the RS-232C.

- ④ Before connection, read the instruction manual for the equipment to be connected.
- ⑤ Use the connecting cables for a modem.
(Example) PC-8895 (NEC), cable sets #705 and #724 (EPSON)

RS-232C Pin Connection

Pin No.	Signal Name	Direction	Meaning
1	FG	← →	Frame ground
2	RXD	In	Receive data
3	TXD	Out	Transmit data
4	RTS	In	Request to send
5	CTS	Out	Clear to send
6	DSR	Out	Data set ready
7	SG	← →	Signal ground
25	—	—	Used on the balance side (SG)
8~24	N.C.		No connection

Pin No.	Signal Name
3, 5	Sending loop
Peripheral equipment	Case
Others	No connection

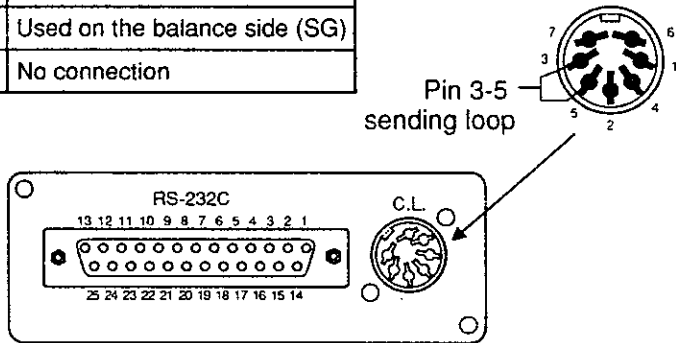

OP-03 Circuit Diagram

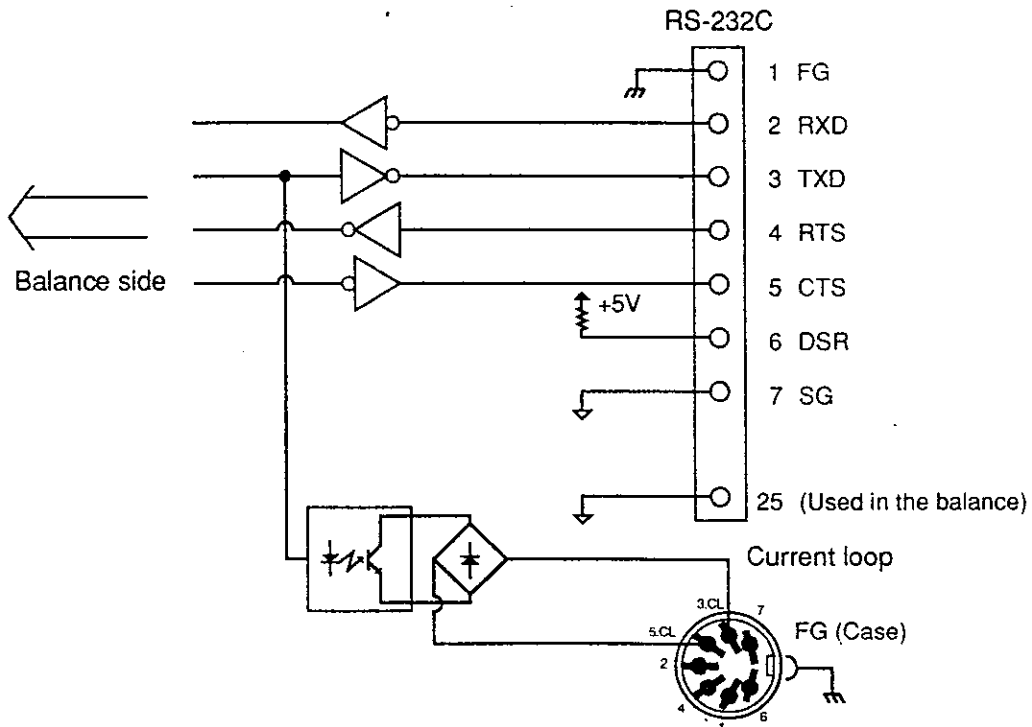



OP-03 Data Output



There are four data output modes each of which can be changed through “C-Parameter Settings” (refer to page E-10).

- Key mode Press the key on the balance to output data. There are two types of modes: Key A and Key B.
- Auto Print mode When the balance becomes stable, the data is automatically output at once. There are two types of modes: Auto Print A and Auto Print B.
- Stream mode Data is output each time the display is rewritten.
- Command mode Data is output by the command given from a computer.



Print Key Mode

In the key mode, when the key is pressed and the balance is stable, the data is output one time. In this case, the display will blink once to indicate data output. There are two types of modes: Key A in which the key is accepted only when the balance is stable, and Key B in which the key is accepted when the balance is either stable or unstable. Data is output after the balance becomes stable.

- Print 0 C5 ----- Key A mode
- Print 1 C5 ----- Key B mode



Auto Print Mode

Data is automatically output one time when the balance is stable. Thereafter, data will not be output unless certain conditions are met. It is convenient to read data on which the weight of an object is measured continuously. The conditions of auto print can be changed through combinations of internal settings.

- Print 2 C5 ----- Auto Print A

When the balance becomes stable at a fixed value or greater width (“Auto print width” “RP - b C5” on page E-10) away from zero, one group of data is output. Once output, the displayed value must return to within the auto print width, enabling the next data output. The polarity of data to be output can be selected through “RP - P C5” (on page E-10).

Print 3 C5 Auto Print B

When the balance becomes stable at a fixed value or greater width (“**Auto print width**” “*RP-b* C5” on **page E-10**) away from zero, one group of data is output. The polarity of data to be output can be selected through “*RP-P* C5” (**page E-10**).

Stream Mode

Print 4 C5 Stream mode

Each time the display is updated, data is output.

- Unlike the key or auto print mode, data when the balance is unstable is also output. The display does not blink during data output.
- The display is updated 4 times/sec in the stable state and 8 times/sec in the unstable state at shipment time. The display update rate may be set by “*SPEED* C1” (**page E-13**).
- With “*LES* C6” (**page E-13**) set to “1”, when the RTS terminal of the OP-03 is set to minus, data output is stopped.

Command Mode

Print 5 C5 Command mode

Data is output through commands of external equipment such as a computer.

- In addition to the data output command, there are many commands which can externally control the balance.



Connection to AD-8117

To connect the balance to the AD-8117 compact printer (option), set the C-Parameter settings as follows:

Select one of:	{	<i>Pr int</i> 0	C5	(Key A mode, AD-8117 is used in MODE 1.)
		<i>Pr int</i> 1	C5	(Key B mode, AD-8117 is used in MODE 1.)
		<i>Pr int</i> 2	C5	(Auto Print A mode, AD-8117 is used in MODE 1.)
		<i>Pr int</i> 3	C5	(Auto Print B mode, AD-8117 is used in MODE 1.)
		<i>Pr int</i> 4	C5	(Stream mode, AD-8117 is used in MODE 2.)

<i>CODE</i> 0	C5	(Data No. not assigned.)
<i>bPS</i> 2	C5	(2400 bps)
<i>PAR</i> 0	C5	(Parity: EVEN)
<i>bit</i> 0	C5	(Bits per character: 7 bits)
<i>Stop</i> 0	C5	(Stop bit: 1 bit)
<i>Cr-LF</i> 0	C5	(Terminators <CR> and <LF>)
<i>TYPE</i> 0	C5	(A&D standard format)
<i>dP</i> 0	C5	(Decimal point: 2EH point)
<i>ETS</i> 0	C5	(Setting for a personal computer or an AD-8117)

- Connect using the cable (KO: 256A) supplied with the AD-8117.
- The connection for a current loop requires an adaptor cable (Option 01 of AD-8117).
- For details about the AD-8117, refer to the printer instruction manual.



Connection to AD-8117A

The connection of the balance to the AD-8117A compact printer (option) will allow printing of the data number, code number and the C-Parameter setting list. Set the C-Parameter settings as follows:

Select one of:	{	<i>Print</i> 0	C5	(Key A mode)
		<i>Print</i> 1	C5	(Key B mode)
		<i>Print</i> 2	C5	(Auto Print A)
		<i>Print</i> 3	C5	(Auto Print B)
		<i>Print</i> 4	C5	(Stream mode)
		<i>PAUSE</i> 0	C5	(Setting data output intervals)
		<i>bPS</i> 2	C5	(2400 bps)
		<i>PAR</i> 0	C5	(Parity: EVEN)
		<i>bit</i> 0	C5	(Bits per character: 7 bits)
		<i>STOP</i> 0	C5	(Stop bit: 1 bit)
		<i>CR-LF</i> 0	C5	(Terminators <CR> and <LF>)
		<i>TYPE</i> 0	C5	(AD-8117A format)
		<i>ETS</i> 0	C5	(Setting for a personal computer or an AD-8117A)

- Connect the balance using the cable (KO: 256A) supplied with the AD-8117A.
- The connection for a current loop requires an adapter cable (Option 01 of AD-8117A).
- Keys and switches on the AD-8117A except the FEED key and POWER switch do not function.
- For details about the AD-8117A, refer to the printer instruction manual.



Sample Computer Programs

- The C-Parameter settings and an example of a program for the connection of the balance to an IBM PC-AT are shown below:

- The C-Parameter settings of the balance

<i>Print</i>	<i>5</i>	C5	(Command mode)
<i>bPS</i>	<i>3</i>	C6	(4800 bps)
<i>PAR</i>	<i>0</i>	C6	(Parity: Even)
<i>bit</i>	<i>0</i>	C6	(Data bits: 7)
<i>Stop</i>	<i>0</i>	C6	(Stop bit: 1)
<i>Er-LF</i>	<i>1</i>	C6	(Terminators <CR>)
<i>TYPE</i>	<i>0</i>	C6	(A&D standard format)
<i>t-UP</i>	<i>0</i>	C6	(Timer ON)
<i>dP</i>	<i>0</i>	C6	(Decimal point 2EH)
<i>E-Code</i>	<i>1</i>	C6	(Transmit error code)
<i>ETS</i>	<i>0</i>	C6	(Setting for personal computer or AD-8117)

- Example of a program for a personal computer [IBM PC-AT]

After the re-zero operation, access data items one after another. The contents are displayed by the computer.

```

10 OPEN "COM1:4800" AS #1
20 PRINT #1, "R"+CHR$( &HD)
30 LINE INPUT #1, AK$           {Reply to "R" command}
40           IF AK$ <> CHR$(6) THEN GOTO 130
50 LINE INPUT #1, AK$           {End of RE-ZERO}
60           IF AK$="EC, E0" THEN GOTO 140
70           IF AK$="EC, E11" THEN GOTO 150
80 FOR I=1 TO 1000: NEXT I
90 PRINT #1, "Q"+CHR$(13)
100 INPUT #1, HD$, DT$
110 PRINT HD$, DT$
120 GOTO 80
130 PRINT "BALANCE NOT READY!": CLOSE: END
140 PRINT "COMMUNICATION ERROR!": CLOSE: END
150 PRINT "ERROR 1... BALANCE NOT STABLE!": CLOSE: END

```

Weighing Data Output Format



The weight data output format is set by “TYPE c6” (refer to “Data Format” on page E-13). This setting provides the following three formats:

- ① A&D format Applicable to A&D peripheral equipment such as the AD-8117 printer. (TYPE 0 c6)
- ② AD-8117A format Applicable to the AD-8117A printer. (TYPE 1 c6)
- ③ KF format Applicable to the Karl Fischer's moisture tester which cannot be connected in the A&D standard format. (TYPE 2 c6)

A&D Standard Format

This format is applicable to A&D peripheral equipment such as the AD-8117.

- At the beginning, there is a header of two characters indicating the data type and status.
- Data is signed and output up including leading zeros.
- The unit is represented in three characters.
- One data group is fixed at 15 characters (excluding a terminator).

AD-8117A Format

This format is applicable to AD-8117A.

- When not over, there is a header of two characters at the beginning.
- Data is signed or unsigned if it is zero.
- The leading zeros are replaced by spaces.
- The unit is represented in three characters.
- One data group is fixed at 16 characters (excluding a terminator).

KF Format

This format is applicable to the Karl Fischer's moisture tester which cannot be connected in the A&D standard format.

- There is no header.
- When not over, there is a sign at the beginning (no sign when data is zero).
- The leading zeros are replaced by spaces.
- The stable data is assigned with a unit (only g).
- One data group is fixed at 13 characters (excluding a terminator).

Weighing Data Format Examples

! In the following examples, the space code is represented by (20H).

Stable Data Examples

▶ Example : Display = "0.0000g":

	1	2	3	4	5	6	7	8	9	10	11	12	13	14	15	16	17
A&D Standard	S	T	,	+	0	0	0	.	0	0	0	0	(20H)	(20H)	g	cr	
AD-8117A	W	T	(20H)	(20H)	(20H)	(20H)	(20H)	0	.	0	0	0	0	(20H)	(20H)	g	cr
KF	(20H)	(20H)	(20H)	(20H)	0	.	0	0	0	0	(20H)	g	(20H)	cr			

▶ Example : Display = "100.5678g":

	1	2	3	4	5	6	7	8	9	10	11	12	13	14	15	16	17
A&D Standard	S	T	,	+	1	0	0	.	5	6	7	8	(20H)	(20H)	g	cr	
AD-8117A	W	T	(20H)	(20H)	+	1	0	0	.	5	6	7	8	(20H)	(20H)	g	cr
KF	+	(20H)	1	0	0	.	5	6	7	8	(20H)	g	(20H)	cr			

▶ Example : Display = "100567.8mg":

	1	2	3	4	5	6	7	8	9	10	11	12	13	14	15	16	17
A&D Standard	S	T	,	+	1	0	0	5	6	7	.	8	(20H)	m	g	cr	
AD-8117A	W	T	(20H)	(20H)	+	1	0	0	5	6	7	.	8	(20H)	m	g	cr
KF	+	(20H)	1	0	0	5	6	7	.	8	(20H)	(20H)	(20H)	cr			

▶ Example : Display = "105.678ct":

	1	2	3	4	5	6	7	8	9	10	11	12	13	14	15	16	17
A&D Standard	S	T	,	+	0	1	0	5	.	6	7	8	(20H)	c	t	cr	
AD-8117A	W	T	(20H)	(20H)	(20H)	+	1	0	5	.	6	7	8	(20H)	c	t	cr
KF	+	(20H)	(20H)	1	0	5	.	6	7	8	(20H)	(20H)	(20H)	cr			

Unstable Data Example

▶ Example : Display = “-98.3210g”



	1	2	3	4	5	6	7	8	9	10	11	12	13	14	15	16	17
A&D Standard	U	S	,	-	0	9	8	.	3	2	1	0	(20H)	(20H)	g	↵	
AD-8117A	U	S	(20H)	(20H)	(20H)	-	9	8	.	3	2	1	0	(20H)	(20H)	g	↵
KF	-	(20H)	(20H)	9	8	.	3	2	1	0	(20H)	(20H)	(20H)	↵			

Overload Data Examples

▶ Example : Display = “Eg”



	1	2	3	4	5	6	7	8	9	10	11	12	13	14	15	16	17
A&D Standard	O	L	,	+	9	9	9	9	9	9	9	E	+	1	9	↵	
AD-8117A	(20H)	(20H)	(20H)	(20H)	(20H)	(20H)	(20H)	(20H)	E	(20H)	(20H)	(20H)	(20H)	(20H)	(20H)	(20H)	↵
KF	(20H)	(20H)	(20H)	(20H)	H	.	(20H)	(20H)	(20H)	(20H)	(20H)	(20H)	(20H)	(20H)	↵		

▶ Example : Display = “-Eg”

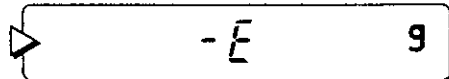

	1	2	3	4	5	6	7	8	9	10	11	12	13	14	15	16	17
A&D Standard	O	L	,	-	9	9	9	9	9	9	9	E	+	1	9	↵	
AD-8117A	(20H)	(20H)	(20H)	(20H)	(20H)	(20H)	(20H)	-	E	(20H)	(20H)	(20H)	(20H)	(20H)	(20H)	(20H)	↵
KF	(20H)	(20H)	(20H)	(20H)	L	.	(20H)	(20H)	(20H)	(20H)	(20H)	(20H)	(20H)	(20H)	↵		



Independent Data Formats



Output formats of data other than weight data are common irrespective of which format is selected by the C-Parameter setting.
In the following examples, the space code is represented by (20H).



Data No.

- The data no. is always a 6-digit integer. The upper figures less than 6 digits are filled with 0. After output, the numerical value is increased by 1.
(999999 → 000000)

1	2	3	4	5	6	7	8	9	10	11
N	o	.	(20H)	0	1	2	3	4	5	cr



Code No.

- The code no. consists of 6 characters including space and hyphen (-). It cannot be output with weight data every time.

1	2	3	4	5	6	7	8	9	10	11	12
C	O	D	E	(20H)	0	1	(20H)	3	-	5	cr

Code No.



Parameter Setting Value

- (n) = Parameter group number
- (m) = Parameter number
- (i) = Parameter name (5 characters)
- (v) = Parameter setting value

1	2	3	4	5	6	7	8	9	10	11	12	13	14	15
C	(n)	(m)	(20H)	(20H)	(i)	(i)	(i)	(i)	(i)	(20H)	(20H)	(20H)	(v)	cr
C	0	0	(20H)	(20H)	S	T	B	-	B	(20H)	(20H)	(20H)	0	cr

<input type="checkbox"/> Stb-b	? C0	Stability band width	FC00:0
	.	±1 digit	



Various Commands for the RS-232C Serial Interface



A given time (delay time) is needed to output a command to the balance after a personal computer has received "AK (06H)" from the balance.

The delay time is set according to the number of operations from "FOR" to "NEXT" and varies according to the clock and performance of the personal computer used. If a program does not run normally, increase the number of operations from "FOR" to "NEXT".

[Example of basic program]

```

1..
123 LINE INPUT #1, AK$           {AK received}
124 FOR I=1 TO 100:NEXT I       {Delay}
125 PRINT #1, "Q"               {Q command output}
1..

```

- When internal setting "AK" and an error code output in command mode" is set to "0" (E-[od] c6), the balance does not output "AK (06H)" or the error code. Refer to **page E-13**.
- When this setting is set to 1 (E-[od] l c5), after receiving a specific command (command other than data request), the balance outputs the ID code "AK (06H)".
This "AK" is output not only when the specified command is received but also after the command is executed. When the command is not executed, the HA series balance outputs the error code to the personal computer.
- A space code is represented as (20H).

1)

?	#
---	---

 Data No. output command

Command

?	#	↵
---	---	---

Example of response

N	o	.	(20H)	1	2	3	4	5	6	↵
---	---	---	-------	---	---	---	---	---	---	---

2)

?	\$
---	----

 Code No. output command

Command

?	\$	↵
---	----	---

Example of response

C	O	D	E	(20H)	1	2	3	-	5	6	↵
---	---	---	---	-------	---	---	---	---	---	---	---

3)

?	A	L	L
---	---	---	---

 All set values output command

This command outputs all set values stored internally.

Command

?	A	L	L	cr
---	---	---	---	----

Example of response

Target weight	T	G	,	+	0	0	2	.	0	0	0	0	(20H)	(20H)	g	cr
Calibration weight set value	C	W	,	+	1	5	0	.	0	0	0	0	(20H)	(20H)	g	cr
Coefficient output command in MLt mode	M	L	,	+	2	5	.	0	0	0	0	0	cr			
Data No.	N	o	.	(20H)	1	2	3	4	5	6	cr					
Code No.	C	O	D	E	(20H)	1	2	3	—	5	6	cr				

4)

?	C	(n)	(m)
---	---	-----	-----

 Parameter setting output command

This command outputs the set value of the parameter setting. The parameter group number and parameter number must be preceded by “?C”. Refer to **“Parameter Setting Value”** on page F-12.

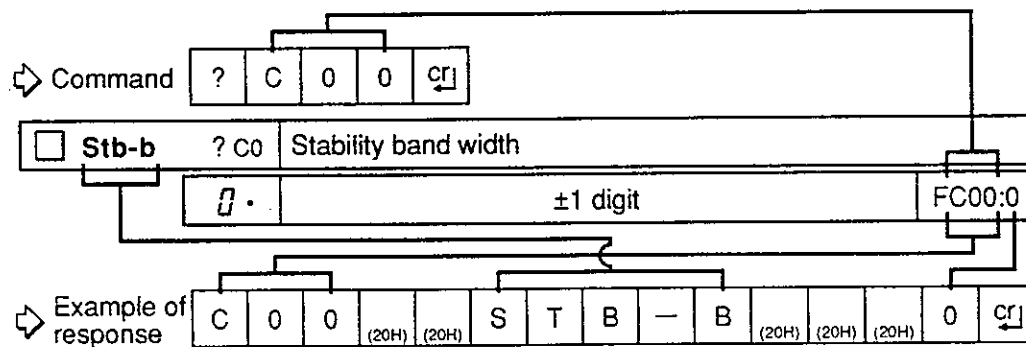

5)

?	C	W
---	---	---

 Set calibration weight value output command

Command

?	C	W	cr
---	---	---	----

Example of response

C	W	,	+	1	5	0	.	0	0	0	0	(20H)	(20H)	g	cr
---	---	---	---	---	---	---	---	---	---	---	---	-------	-------	---	----

6)

?	M	L
---	---	---

 Coefficient set command in MLt mode

(Refer to page B-13.)

Command

?	M	L	cr
---	---	---	----

Example of response

M	L	,	+	2	5	.	0	0	0	0	0	cr
---	---	---	---	---	---	---	---	---	---	---	---	----

7)

?	T	G
---	---	---

 Target weight output command

Command

?	T	G	↵
---	---	---	---

Example of response

T	G	,	+	0	0	2	.	0	0	0	0	(20H)	(20H)	g	↵
---	---	---	---	---	---	---	---	---	---	---	---	-------	-------	---	---

8)

?	U
---	---

 Unit check command

- This command outputs the unit currently being displayed. It is represented in three characters in the same way as those attached to the weight data in the A&D standard format.

Command

?	U	↵
---	---	---

Example of response

(20H)	c	t	↵
-------	---	---	---

9)

#

 Data No. set command

- This command sets the data no. to be added when the next data is output. Transmit an integer of 8 digits or less, following "#". A negative sign or decimal point will cause an error.

Example of output

#	1	2	3	4	5	6	↵
---	---	---	---	---	---	---	---

or

#	1	2	3	↵
---	---	---	---	---

10)

\$

 Code No. set command

- This command sets the code no. Transmit 6 characters including space and hyphen (-), following "\$".

Example of output

\$	8	8	-	1	(20H)	2	↵
----	---	---	---	---	-------	---	---

11)

C

 SIR command cancel command

- This command stops the output by the "SIR" command. (Refer to page F-18 "SIR".)

12)

C	A	L
---	---	---

 CAL switch command

This command functions similarly to the

CAL

 key on the panel.

13)

C	W
---	---

 Calibration weight set command

This command sets the calibration weight value for manual calibration. When a unit is not attached after the numerical value, the value is set in the unit being displayed.

When attaching the unit, the value is represented in 3 characters as with those for the response of "?U". It is not possible to set a value exceeding the balancing amount, i.e., a value below around 1/2 of the balancing amount (90.0000g → HA180M, 49,9850g → HA120M), or a minus value.

It is not necessary to attach a leading zero or trailing zero after the decimal point.

Example of output

C	W	1	5	0	.	0	0	1	2	crJ
---	---	---	---	---	---	---	---	---	---	-----

14)

E	X	C
---	---	---

 Manual calibration execute command

This command executes manual calibration.

15)

F	C
---	---

 Parameter setting set command

This command sets the set value of the parameter setting. Transmit the parameter group and parameter number following by a colon (:) and the set value.

(n) Parameter group number
(m) Parameter number
(v) Parameter setting value

[In this example, the parameter setting C0de is set to "0".]

Example of output

F	C	(n)	(m)	:	(v)	crJ
F	C	5	3	:	0	crJ

<input type="checkbox"/> C0de	? C5	Data No. output	
<input type="checkbox"/> .		Data No. not output	FC53:0

16)

M	L
---	---

 Coefficient set command in MLt mode (Refer to page B-13.)

Example of output

M	L	3	.	0	crJ
---	---	---	---	---	-----

(This example shows that the coefficient 3.0 has been newly set.)

17)

F	E	E	D
---	---	---	---

 Feeder start command

This command starts the vibratory spoon AD-1651 feeder.

18)

L	I	S	T
---	---	---	---

 Parameter setting list output command

This command outputs a parameter setting list.

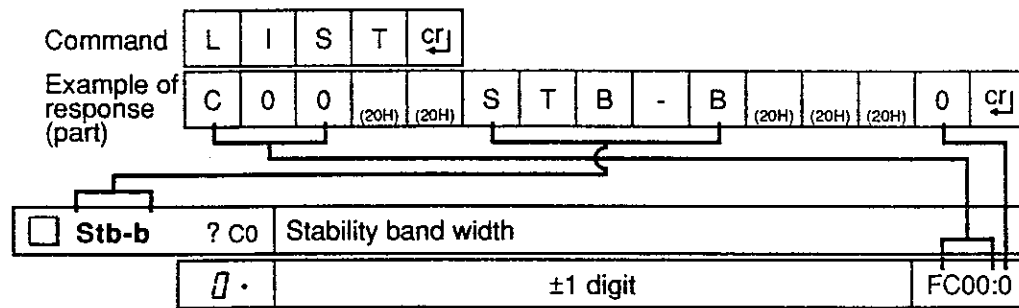

19)

O	F	F
---	---	---

 Display off command

This command turns off the display and does nothing when the display is already off.

20)

O	N
---	---

 Display on command

This command turns on the display and does nothing when the display is already on.

21)

P

 Display on/off command

This command functions similarly to the **ON:OFF** key on the panel

22)

P	R	T
---	---	---

 PRINT key command

This command functions similarly to the **PRINT** key on the panel.

23)

Q

 Weight data output command (instant)

This command outputs one data group irrespective of the stable or unstable state.

24)

R

 RE-ZERO command

This command functions similarly to the **RE-ZERO** key on the panel

25)

R	E	A	D
---	---	---	---

 Weight data output command (instant)

This command outputs one weight data group irrespective of the stable or unstable state. (Same as "Q" command)

26)

S

 Weight data output command (stable)

After receiving the command, this command outputs one stable weight data group. The display blinks once at the time of output.

27)

S	I
---	---

 Weight data output command (instant)

This command outputs one weight data irrespective of the stable or unstable state. (Same as "Q" command)

28)

S	I	R
---	---	---

 Weight data output command (instant repeat)

This command continues the output of the weight data group irrespective of the stable or unstable state. To return from this state (Stream mode by command) to the original state (where the balance can accept other commands), transmit the "C" command. (Refer to **page F-15.**)

29)

R	N	G
---	---	---

 RANGE key command

This command functions similarly to the **RANGE** key on the panel

30)

S	T	O	P
---	---	---	---

 Feeder stop command

This command stops the vibratory spoon AD-1651 feeder.

31)

T	G
---	---

 Target weight set command

- This command sets the target weight when the vibratory spoon is used. When attaching no unit after the numerical value, the value is set in the unit being displayed. When attaching the unit, the value is represented in 3 characters in the same way as those for the response of "?U". It is unnecessary to attach leading zeros or trailing zeros after the decimal point.

Example of output

T	G	2	.	0	0	0	0	(20H)	(20H)	g	cr
---	---	---	---	---	---	---	---	-------	-------	---	----

32)

U

 MODE key command

- This command functions similarly to the

MODE

 key on the panel

33)

U	:	×	×	×
---	---	---	---	---

 Unit change command

- This command changes to the unit represented by $\times \times \times$. $\times \times \times$ is specified by a character string identical to that to be output by the "?U" command. If the character string is different or the unit is not stored, an error (EC, E6) occurs. After executing this command, the unit to be changed by the "?U" command or MODE key is the one to be stored next to the unit being displayed.

Example of output

U	:	(20H)	m	g
---	---	-------	---	---

Error Codes for the Serial Interface

 When an error of some kind occurs in the Command mode, the error code can be output (by “C-Parameter Setting” “E - [od] [c6]”, refer to page E-13.)

- When there is no error, the requested data is output by the data request command (“S”, etc.), and “AK (06H)” is output by other commands. A response is made to all commands, increasing the reliability of external control.
- If the computer program can display the balance error codes, the balance can be set to output these codes.
- In the error code output format, “EC” is attached as a header, followed by “E” and a figure which indicates the error type.

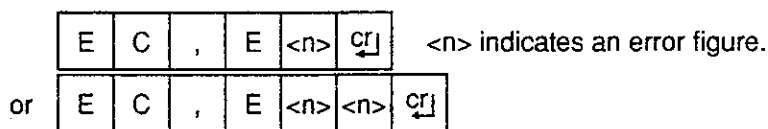

E0 Communication error

- This error occurs when a communication error is detected.
 - ① Parity error The parity does not match. The bits per character may differ from the set value.
 - ② Framing error The bits per character may differ from the set value.
 - ③ Other communication errors

E1 Undefined command

- This error occurs when the command does not match the specified value (excluding the numerical part).

Example

?	t	g	
---	---	---	---

 (Lower-case characters cannot be used.)

E2 Execution disabled state

- This error occurs when the balance cannot execute the command.
 - ① When not in the measuring state A data request command such as “Q” cannot be executed.
 - ② During re-zero A data request command cannot be executed.

E3 Time overrun

- This error occurs when the time required to receive the next start bit after a character other than a terminator was received is over 1 sec. (“**C-Parameter Setting**” is “**t -UP 0**”). Refer to **page E•13.**)

E4 Character overrun

- This error occurs when in the numerical value command, the number of digits on the numerical side exceeds the limit value.

Example

C	W	+	1	5	0	.	1	2	3	4	5	(20H)	(20H)	g	cr
---	---	---	---	---	---	---	---	---	---	---	---	-------	-------	---	----

E5 Terminator error

- This error occurs when setting <CR> <LF>. Characters other than <LF> preceded by <CR> or when <LF> is received before <CR>.

E6 Format error

- This error occurs when a command with a numerical value is used and the description of the numerical part (including ‘:’, ‘+’ and ‘-’) is incorrect.

Example

C	W	1	0	0	(20H)	(20H)	G	cr
---	---	---	---	---	-------	-------	---	----

(When the unit is a gram, lower-case characters cannot be used.)

E7 Set value error

- This error occurs when a command with a numerical value is used and the numerical value exceeds the limit value.

Example

T	G	+	3	2	0	.	0	(20H)	(20H)	g	cr
---	---	---	---	---	---	---	---	-------	-------	---	----

E11 Error indicating the unstable state

- Balance display *Error 1*
- Refer to **page I-3**.

E14 Weighing pan error

- Balance display *Error 4*
- Refer to **page I-4**.

E15 → 18 Error in balance

- Balance display *Error 5 → 8*
- Refer to **page I-4**.

E20 Calibration error

- Balance display *[RL E*
- Refer to **page I-4**.

E21 Calibration error

- Balance display *-[RL E*
- Refer to **page I-4**.

E23 Calibration error

- Balance display *[RL no*
- Refer to **page I-5**.

E40 Re-zero error

- Re-zero impossible

Command Examples Illustrated

 The following is an illustration of communication between a personal computer and HA series balance via RS-232C.

- The C-Parameter setting of the balance is assumed as "E-[od l c5" (output of AK error code).
- A fixed time (delay) is required to output the command to the balance after a personal computer receives "AK (06H)" from the balance. This delay time is provided by the number of operations in the "FOR" to "NEXT" loop and varies with the performance of the personal computer used. If the program does not run normally, increase the number of operations from "FOR" to "NEXT". Change line 124 to read "FOR I=1 to 200: NEXT I"

[Example of BASIC program]

```

1..
123 LINE INPUT #1, AK$      {AK received}
124 FOR I=1 TO 100:NEXT I   {Delay}
125 PRINT #1, "Q"          {Q command output}
1..

```

"P" "ON" Command (Display ON/OFF)

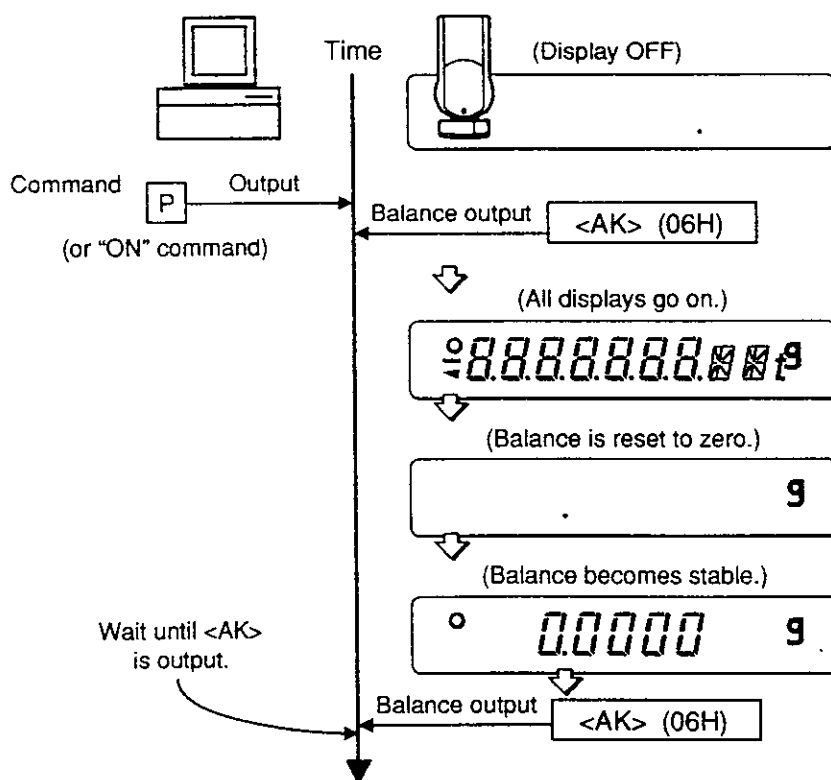

HA SERIES • Section G

Vibratory Spoon
AD-1651 (Option)

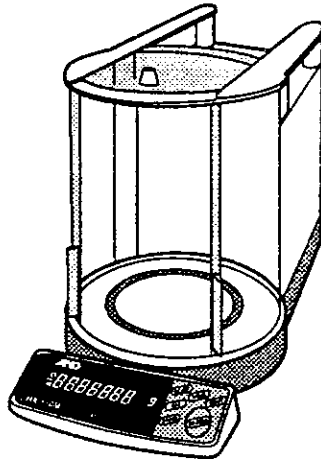



Vibratory Spoon AD-1651

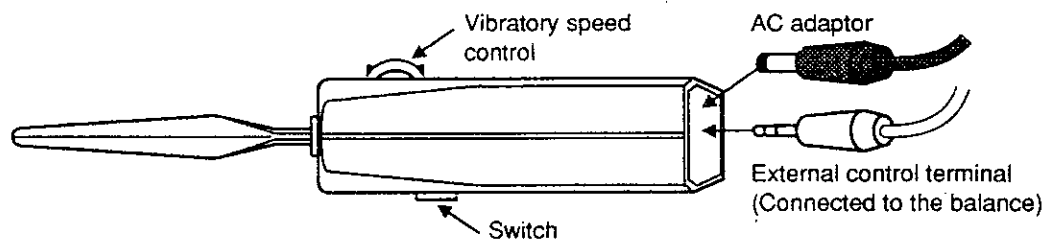

- The connection of the balance to the **Vibratory Spoon AD-1651** (option) will facilitate weighing powder and granular materials.
- Set the C-Parameter setting "**Selection of External Input Terminal Function**" to "2". Refer to "**[Unit 2.04]**" on **pages E-3 and E-9.**)
- Use a stereo audio cable (available from most electronics supply stores) to connect the "EXT. SW" on the rear of the balance to the AD-1651 "I/O".
- Power is not supplied to the AD-1651 from the balance. Therefore, install a battery or use an AC adaptor.
- When the switch on the AD-1651 is pressed, vibration is started to drop powder or granular materials. When the measured value set into the balance approaches the target weight, vibration is automatically stopped.



Target Weight

- The target weight is set and confirmed by the unit displayed. (When the weight is set by computer command, and the unit of weight is not transmitted.) When the unit of weight is changed after setting, the new one is displayed. (For example, 10g is converted to 50ct.)
- Settings and confirmations of the target weight are made by the keys on the balance front panel or the serial interface (RS-232C).
- The balance will not accept values greater than the capacity.







Notes on Feeding Accuracy

- ▶ Some possible causes of reduced weighing accuracy while using the AD-1651 are:
 - 1) The angle of AD-1651 changes Flowrate change
 - 2) The height of AD-1651 changes Fall change
 - 3) Samples are not uniform. (There are some lumps)
 - 4) Flowrate is too large for the target weight.

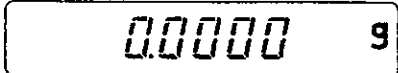
- ▶ During weighing with the HA series balance using the AD-1651, the balance responds at a fast fixed speed irrespective of C-Parameter setting of the "Response Characteristics/Environment" "[OND CO]".

Setting (or Viewing) the Target Weight

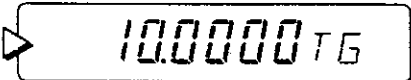
! During operation, press the **ON:OFF** key to return to the normal mode.

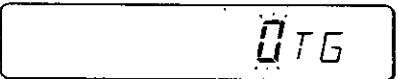
<p>1</p> 	<p>▶ After setting the unit of weight to be used, press the ON:OFF key to turn off the display. (The gram unit is shown in this example.)</p>	
<p>2</p> 	<p>▶ In the display-off state, press and hold the RANGE key.</p>	
<p>3</p> 	<p>▶ With the RANGE key held down, press the ON:OFF key.</p> <p>○ The value previously set is displayed. (10g is set in this example.)</p> <p>○ When only confirming the target weight, the PRINT key is pressed to return to the normal mode.</p>	
<p>4</p> 	<p>▶ Press the MODE key. Zero is displayed in the rightmost digit position and blinks.</p> <p>○ "31.0000g" will be set in the following example.</p>	

5

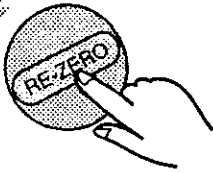

▶ Press the **RE-ZERO** key three times to set "3".



6



▶ Press the **MODE** key to move to the next digit.

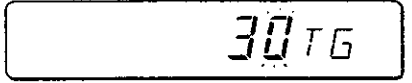

▶ Thereafter, press **RE-ZERO** and the **MODE** keys to set the numerical value.
Use the **RANGE** key to enter a decimal point.

▶ After entering the data, **CAL** can be used to change the polarity.

7

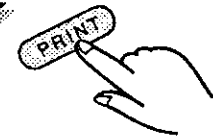

▶ After entering the necessary numerical value, press the **PRINT** key.



○ The set value is stored, and the balance will return to the weighing mode.

○ The set value is stored in memory before the display-off state in step 1.

Setting (or Viewing) the Target Weight (RS-232C)

▶ **Confirming the set value** (by RS-232C)

?	T	G	CF
---	---	---	----

}

A request for output of the current target weight value is made to the balance.

Example of response

T	G	,	+	0	0	2	.	0	0	0	0	(20H)	(20H)	g	CF
---	---	---	---	---	---	---	---	---	---	---	---	-------	-------	---	----

(2g is set in this example.)

▶ **Changing the set value** (by RS-232C)

Example)

T	G	4	.	0	(20H)	(20H)	g	CF
---	---	---	---	---	-------	-------	---	----

4g is newly set in this example.

○ Refer to **page F-19**.

To START Spoon Feeding

- ① Press the switch on the AD-1651.
- ② Send

F	E	E	D
---	---	---	---

 "FEED" command.

Start feeding by either one of the above. Once started, it is unnecessary to continue to press the switch on AD-1651.

To STOP Spoon Feeding

When the display value approaches the target weight, weighing is automatically stopped.

- ① Press the switch on AD-1651 again.
- ② Send

S	T	O	P
---	---	---	---

 "STOP" command.

Addition after Stop

If the displayed value is below the target value, restart feeding according to the procedures indicated in "Feeding Start".

If the value exceeds the target value, a restart cannot be performed unless the switch on the AD-1651 is pressed continuously.

Connector Hook-up

Connect the plug supplied to the "EXT. SW" jack on the rear of the balance as shown in the figure below:

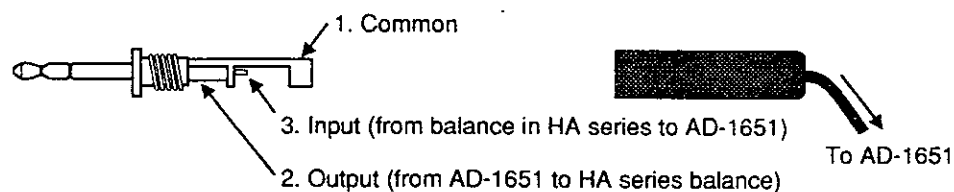

HA SERIES • Section H

Anti-theft Device

OP-11 (Option)

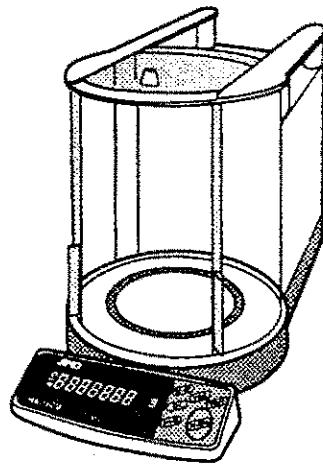



OP-11 Installing Procedure



- The OP-11 is an anti-theft device to securely connect the balance table to the balance to prevent theft.
- Locking table type
- The balance table mounting section should have a thickness of 10cm max.
- The balance table mounting section should have a $\phi 20\text{mm}$ to $\phi 25\text{mm}$ hole.

1

- ▶ Cut a hole ($\phi 20 \sim \phi 25\text{mm}$) in the balance table.

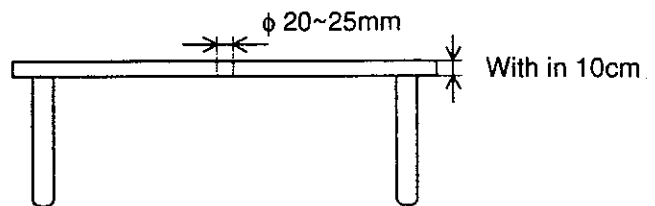

2

- ▶ Remove the two screws on the bottom of the balance to mount the fittings.

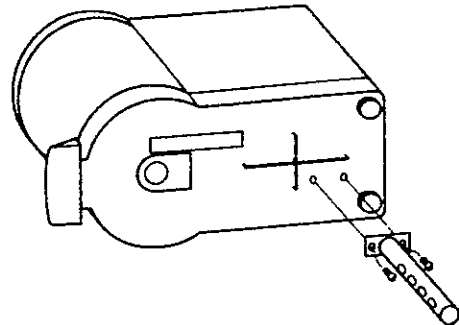

3

- ▶ Put the fitting through the table hole and lock it.

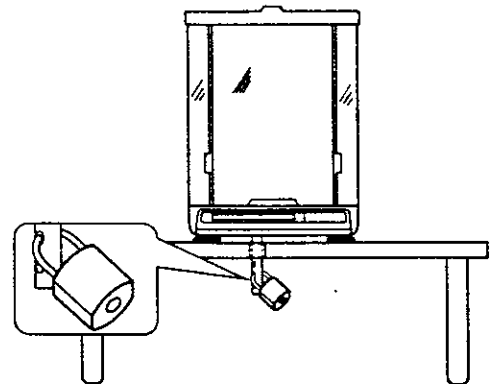

HA SERIES • Section I

Troubleshooting

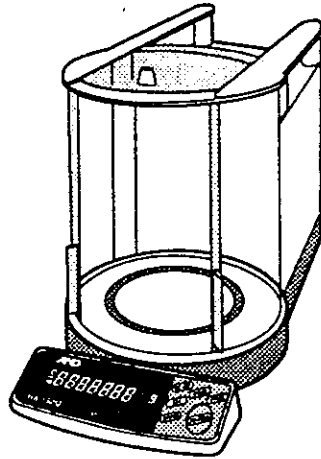



Trouble

Display does not stabilize.

- Check if the balance table is steady. Use a steady table.
- Check if the draft ring and weighing pan are set correctly.
- Check if the balance door is closed properly. Close it so that drafts do not cause instability.
- Check if the air flow around the balance is okay. Block off the air flow as much as possible.
- After checking all of the above, set internal setting “[d r d c o]”, as needed. (For how to change, refer to **page E-3.**)
- Ask for servicing if the display remains unstable.

There is no repeatability of the measured value. An apparently incorrect value is displayed.

- Check if the balance is leveled using the level gauge.
- Check if the balance has been warmed up for over one hour.
- Check if calibration has been performed under stable conditions.
- Check if the **RE-ZERO** key has been pressed before putting the sample on the pan.
- Check if the sample comes into contact with any part of the weighing chamber other than the pan.
- Check if the sample is on the center of the pan. Putting the sample on the edge of the pan may cause an error.
- Check if the sample has been charged by static electricity. If charged, put the sample in the conductive container for measurement. (Refer to **page D-5.**)
- Check if a magnetic substance such as iron has been used as a sample. Since the HA series uses a magnet, measurement of a magnetic substance may cause an error. In this case, perform underhook weighing. (Refer to **page D-7.**)
- Check the air density for the day of data recording. With changes in atmospheric pressure, temperature, and humidity, the air density may cause fluctuation the air buoyancy of the sample, causing reduced reliability of the results of a measurement. Special care should be given to a relatively large volume sample.
- After checking the above, if there is still up repeatability of the balance, ask for servicing.

- ❑ The power indicator (decimal point at the left side) does not illuminate even when the AC adaptor is plugged in. The display does not react, even if the **ON:OFF** key is pressed.
 - Replace the fuse on the rear of the balance according to the procedure shown in the figure below.

Fuse Replacement

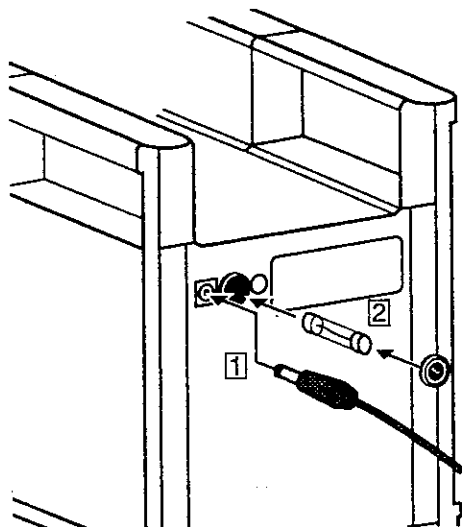

1. Disconnect the AC adaptor cable from the balance. **1**
2. With the fuse holder pressed in, make a half turn to the left and pull out the fuse with the cap.
3. Replace the fuse in the cap with a new 500mA time lag fuse. **2**
4. After replacement, if the fuse burns out again, ask for servicing.

Error Display and Countermeasures

Power failure

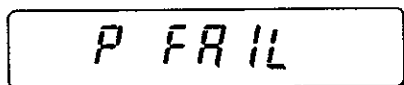

“P FAIL” indicates that the power was interrupted.

- ▶ Press the **ON:OFF** key.

Internal operation error

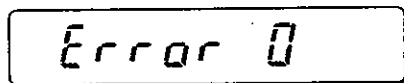

“Error 0” indicates that an error occurred during the internal operation of the balance.

- ▶ Ask for servicing.

Error indicating unstable state

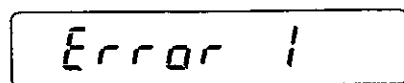

“Error 1” indicates that the zero display does not appear because the balance is unstable during the re-zero operation.

- ▶ Check for vibration and air flow and press the **RE-ZERO** key. Refer to “**Trouble**” on page I-2.

 Weighing pan error

Error 4

“Error 4” indicates that the **ON/OFF** key was pressed with the weighing pan, balance weight, and pan support assembled incorrectly, or with an object on the weighing pan.

- ▶ Assemble the weighing pan, balance weight, and pan support correctly. Remove any objects from the weighing pan. If the error still continues, ask for servicing.

 Memory error

Error 5

Error 6

Error 7

Error 8

“Error 5” to “Error 8” indicates a balance memory error.

- ▶ Disconnect the AC adaptor from the balance and reconnect it after several seconds. If this error still continues, ask for servicing.

 Weighing pan error

-E g

“-E” indicates that the weighing pan, balance weight, and pan support are not assembled correctly.

- ▶ After assembling correctly, if the error still continues, ask for servicing.

 Overload error

E g

“E” indicates that the weight of a measured object exceeds the balancing capacity.

- ▶ After removing the measured object, if the error still continues, ask for servicing.

 Calibration error

-CAL E

CAL E

“-CAL E” indicates that the weight is too light for calibration.

“CAL E” indicates that the weight is too heavy for calibration.

- ▶ Check that all objects are removed from the pan, the weighing pan is assembled correctly, and the value of the weight corresponds to the set value, then press the **RE-ZERO** key.



“CAL no” indicates that calibration cannot be performed because the balance is unstable due to factors such as vibration and air flow.

- ▶ Check for vibration and air flow, and then press the **RE-ZERO** key.
Refer to “**Best Conditions For Weighing**” on page **A-3**.



The unit display section blinks. This blinking does not indicate an error but a change in the ambient temperature.

- ▶ After about two minutes, calibration is automatically started by the auto self-calibration function.
Refer to “**Automatic Self-calibration**” on page **C-3**.



“Δ” of the unit display section blinks. This blinking does not indicate an error but an change in the ambient temperature. Only a warning is given and calibration is not started automatically. This is because the C-Parameter setting is set to “CAL 1 C2”. Refer to page **E-7**.



Maintenance

Maintenance method

- Keep the inside of the balance clean. The adhesion of samples to the weighing pan causes error in weighing.
- If the balance is dirty, wipe with a soft cloth. Never use solvents such as thinner.
- If the door glass, pan, and floor plate (made of glass) are dirty, clean with alcohol.

Uneven brightness of the display

The prolonged disuse of the balance may produce unevenness in display brightness. In this case, take the following measures:

- Turn off the display.
- With the **RE-ZERO** key held down, press the **ON:OFF** key.
- All displays are illuminated.
- Leave it on for several hours.
- Press the **ON:OFF** key to cancel this state.

A&D

A&D Company, Limited

3-23-14 Higashi-Ikebukuro, Toshima-ku, Tokyo 170 Japan
Telephone: [81] (03) 5391-6132 Fax: [81] (03) 5391-6148 Telex: 2422816 AANDD J

A&D ENGINEERING, INC.

1555 McCandless Drive, Milpitas, CA, 95035 U.S.A.
Telephone: [1] (408) 263-5333 Fax: [1] (408) 263-0119

A&D INSTRUMENTS LTD.

Abingdon Science Park, Abingdon, Oxford OX14 3YS England
Telephone: [44] (0235) 550420 Fax: [44] (0235) 550485

A&D MERCURY PTY. LTD.

32 Dew Street, Thebarton, South Australia 5031 Australia
Telephone: [61] (08) 352-3033 Fax: [61] (08) 352-7409

A&D KOREA Limited

3rd Floor Hanam Bldg 44-27 Yoido-dong Youngdeungpo-ku Seoul, Korea
Telephone: [82] (02) 784-4264 Fax: [82] (02) 784-6557