

GX-A series
GF-A series
GX-AE series
GX-AWP series
GF-AWP series
GX-M series
GF-M series

INSTRUCTION MANUAL

Communication Manual



This Manual and Marks Herein

Note for precautions:

Caution Describes the points to be careful for appropriate use.

Note Describes 'highly possible to be handled inappropriately' or 'general advice in using the product'.

About This Manual

- 1) Unauthorized reproduction of any part or all of the contents of this document is strictly prohibited.
- 2) The contents of this document are subject to change without notice.
- 3) If you have any doubts about or notice any mistakes in the contents of this document, please contact your dealer or our nearest sales office.
- 4) As for any claims for damages, loss of profit, etc. related to the operation of this machine regardless of the proposed actions from above-mentioned clause 3), our company bears no responsibility with regard to such claims.

© 2019 A&D Company, Limited.

Do not copy or modify this document without the permission of A&D Company, Limited.

Microsoft, Windows, Excel, Word are trademarks of the Microsoft Corporation registered in the United States and other countries.

Table of contents

1. Introduction	5
1-1. Applicable models	5
1-2. Features of the communication function	5
1-2-1. Using RS-232C / extension RS-232C interface	6
1-2-2. Using USB interface	7
1-2-3. Connecting multiple peripheral devices	7
2. Interface Specifications	8
2-1. RS-232C	8
2-2. USB	9
3. Connecting Peripheral Devices	10
3-1. Cables needed to connect to peripheral devices	10
3-2. About data output method	11
3-3. Specific examples when connecting multiple peripheral devices at the same time	13
4. Printing Weighing Values to the Printer	17
4-1. In case of AD-8127	17
4-2. In case of AD-8126	19
5. Connecting to a PC	20
5-1. Quick USB mode	20
5-2. Virtual COM mode	21
5-3. RS-232C	22
5-4. WinCT data transmission software (USB Virtual COM mode or RS-232C)	22
5-5. Notes when using quick USB	23
6. Data output	24
6-1. Data output mode	24
6-2. Weighing data format	26
6-3. Output examples of weighing data format	29
6-4. Other data formats	31
7. Commands	33
7-1. Control commands	33
7-2. The <AK> code and error codes	36
7-3. Command usage examples	37
8. Error codes	42
8-1. Error codes list	42
9. The UFC Function	44
9-1. UFC program commands	44
9-2. Examples of creating UFC program commands	46
10. Function Table	47
10-1. Setting The Function Table	47
10-2. List of functions (communication class only)	49

11. Key Lock Function	52
11-1. Locking all key switches	52
11-2. Locking specified key switches	53
12. Checking the Software Version of the Balance	54

1. Introduction

This communication manual is a supplementary instruction manual for connecting the balance to peripheral devices such as PCs and printers through the use of its communication function.

Operations differ depending on the software version of the balance. To confirm the software version, refer to section "12. Checking the Software Version of the Balance".

1-1. Applicable models

This communication manual applies to the following models:

- GX-A Series GX-M Series GX-AWP Series
- GF-A Series GF-M Series GF-AWP Series
- GX-AE Series

1-2. Features of the communication function

RS-232C interface

The RS-232C interface is provided as standard, enabling communication similar to conventional balances.

[Balance rear side]

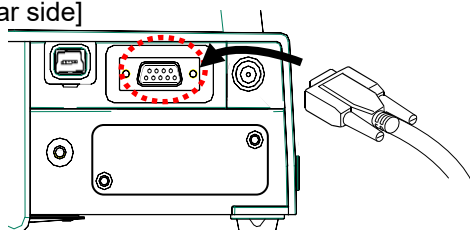

GX-A / GF-A / GX-AWP / GF-AWP series

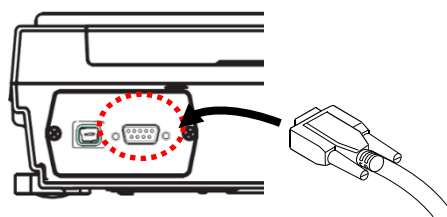

GX-M / GF-M series

USB interface

A USB interface is provided as standard and you can select between a quick USB for inputting the weighing result directly into the PC software or bi-directional communication using a virtual COM port.

[Balance rear side]

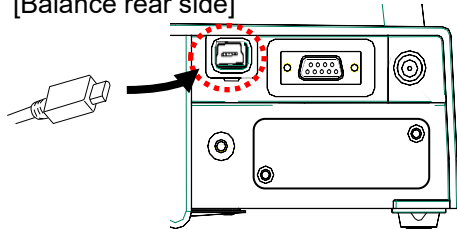

GX-A / GF-A / GX-AWP / GF-AWP series

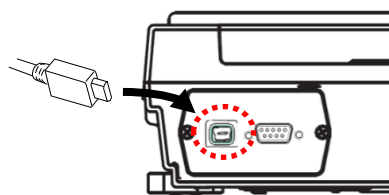

GX-M / GF-M series

Extension RS-232C interface (GX-A / GF-A / GX-AWP / GF-AWP series)

An isolated RS-232C interface can be added by using the GXA-03 for GX-A / GF-A / GX-AWP / GF-AWP series.

[Balance rear side]

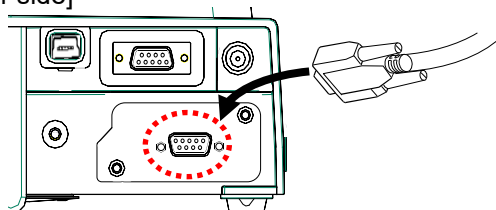

GX-A / GF-A / GX-AWP / GF-AWP series

1-2-1. Using RS-232C / extension RS-232C interface

A variety of peripheral devices described in “Table 1-2-1” can be connected.

Table 1-2-1. Examples of connectable peripherals

Peripheral device		Example															
Name	Model *1																
Mini printer	AD-8126																
Multi-functional printer	AD-8127	The balance can be wirelessly connected to the printer by using the optional AD-8529PR-W (Bluetooth converter).															
Remote display	AD-8920A																
Remote controller	AD-8922A	An additional printer can be connected to the AD-8922A.															
Remote controller for weighing lines	AD-8923-BCD	The BCD output from the AD-8923-BCD allows the weighing value to be imported to the PLC.															
	AD-8923-CC	The weighing data can be imported to the PLC by the CC-Link of the AD-8923-CC.															
PLC		In addition to connecting to the PLC via RS-232C, weighing values can be imported to the PLC via BCD or CC-Link using a remote controller or extension controller for weighing lines.															
PC		<p>The following products are available according to your needs.</p> <table border="1"> <thead> <tr> <th>Name</th> <th>Model</th> <th>*1</th> </tr> </thead> <tbody> <tr> <td>USB convertor / cable set</td> <td>AX-USB-9P</td> <td>*2</td> </tr> <tr> <td>Bluetooth convertor</td> <td>AD-8529PC-W</td> <td>*2</td> </tr> <tr> <td>Weighing data logger</td> <td>AD-1688</td> <td>*3</td> </tr> <tr> <td>Quick USB adapter</td> <td>AD-8527</td> <td>*3</td> </tr> </tbody> </table>	Name	Model	*1	USB convertor / cable set	AX-USB-9P	*2	Bluetooth convertor	AD-8529PC-W	*2	Weighing data logger	AD-1688	*3	Quick USB adapter	AD-8527	*3
Name	Model	*1															
USB convertor / cable set	AX-USB-9P	*2															
Bluetooth convertor	AD-8529PC-W	*2															
Weighing data logger	AD-1688	*3															
Quick USB adapter	AD-8527	*3															

- *1 These are representative models as of June 2020. These are subject to change due to the launch or discontinuation of products. For details, refer to the catalogs of each product.
- *2 The device driver and application for importing data such as Win CT must be installed on the PC.
- *3 There is no need to install the device driver or application on the PC.
(The balance cannot be controlled from a PC.)

1-2-2. Using USB interface

Connection can be made to a PC without additional cost. The operation mode of the PC and USB communication can be selected from quick USB mode and bi-directional USB (virtual COM) mode by the function setting $UFnC$ of the balance.

For details, refer to “[5. Connecting to a PC](#)”.

Table 1-2-2. Contents of USB operation mode

USB operation mode	Contents
Quick USB mode	Manual installation of device drivers is not required, and weighing values can be entered directly into an application, such as Excel or Word.
Bi-directional USB (virtual COM) mode	USB can be used like RS-232C. The balance can be controlled from your PC. It is necessary to install on the PC the device driver and application (such as Win CT) to import the weighing data.

1-2-3. Connecting multiple peripheral devices

Multiple peripheral devices can also be connected to the balance at the same time, as follows.

- [1] Printer and PC
- [2] Printer and remote display, etc.
- [3] Remote display and PC.
- [4] Remote display or remote controller and PLC.

For details, refer to “[3-2. About data output method](#)” and “[3-3. Specific examples when connecting multiple peripheral devices at the same time](#)” in “[3. Connecting Peripheral Devices](#)”.

2. Interface Specifications

2-1. RS-232C

Connector: D-Sub 9-pin (male)
Transmission system: EIA RS-232C
Transmission form: Asynchronous, two-way
Data transmission rate: About 5 times per second (ca. 5.21 Hz), about 10 times per second (ca. 10.42 Hz), about 20 times per second (ca. 20.83 Hz)
(Linked with the function " $bA5Fnc/5Pd$ ")

Signal format	Baud rate	600, 1200, 2400, 4800, 9600, 19200, 38400 bps	
	Data bits	7 or 8 bits	
	Parity	EVEN or ODD	(Data bit length 7 bits)
		NONE	(Data bit length 8 bits)
	Stop bits	1 bit	
	Code	ASCII	

Format of 1 character (Data bit length 7 bits)

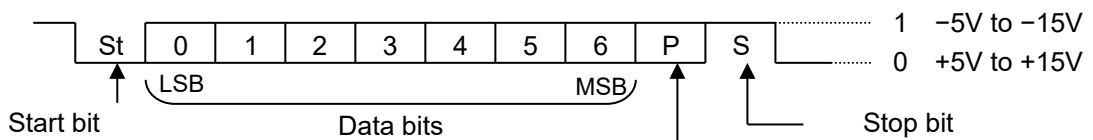

D-Sub 9, pin arrangement

Pin No.	Signal name	Direction	Meaning, remarks
1	-	-	N.C. (same potential with SG) *1
2	TXD	Output	Transmitted data
3	RXD	Input	Received data
4	-	-	N.C.
5	SG	-	Signal ground
6	DSR	Output	Data Set Ready
7	RTS	Input	Request to Send
8	CTS	Output	Clear to Send
9	-	Output	N.C. (12V Output) *1

The signal name is the name of the DTE side except for TXD and RXD.

Connection diagram (when connecting to a PC)

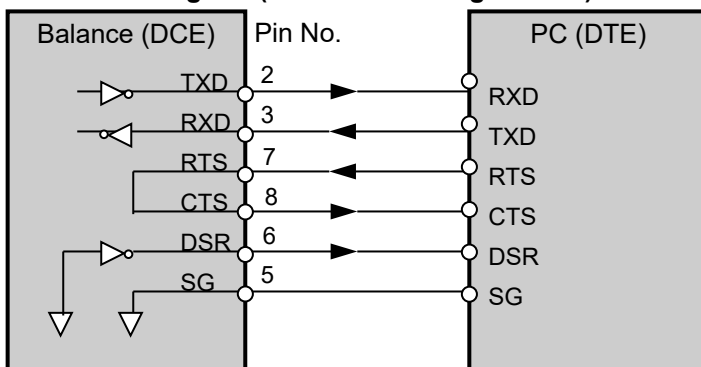

Parity bit

GX-A / GF-A / GX-AE /
GX-AWP / GF-AWP series

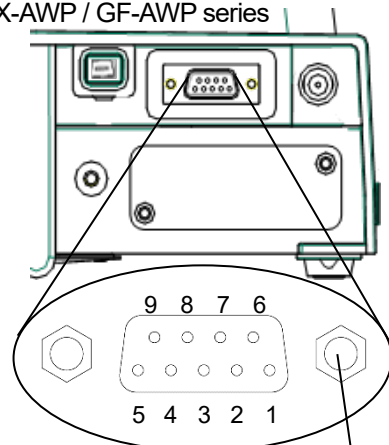

GX-M / GF-M series

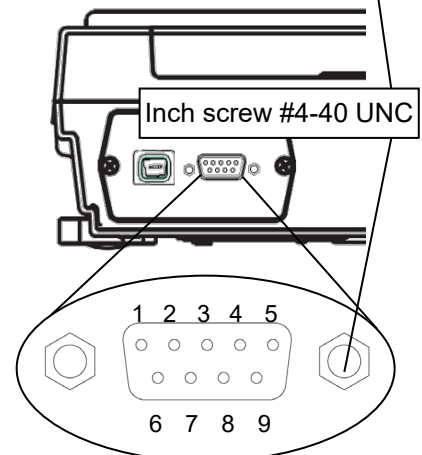

- *1 For use with some A&D products.
 Do not connect the cables to other manufacturers' products such as a PC and PLC.
 Using the wrong connection cable may damage the device. Be sure to check the compatible cable.

2-2. USB

Connector: Mini B (female)
 Standard: USB 2.0
 Device class: HID (Human interface device) : Quick USB
 CDC (Communication device class) : Virtual COM

Mini B, pin arrangement

Pin No.	Signal name	Direction	Meaning, remarks
1	VBUS	Input	Power (connection confirmation)
2	D-	-	Data transmission and reception
3	D+	-	Data transmission and reception
4	ID	-	N.C.
5	GND	-	Signal ground

GX-M / GF-M series

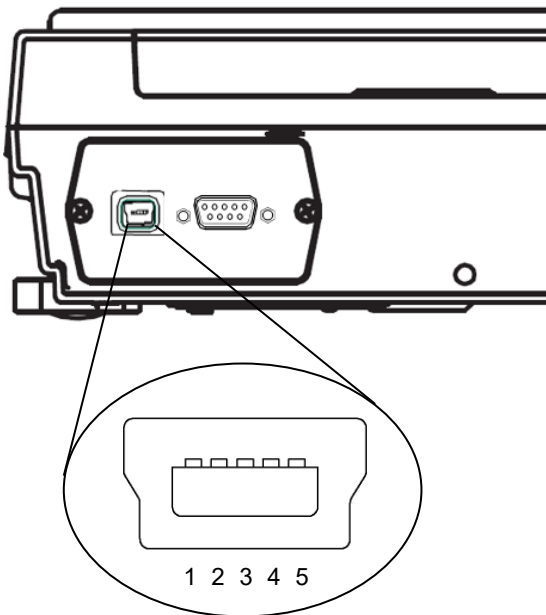

GX-A / GF-A / GX-AE / GX-AWP / GF-AWP series

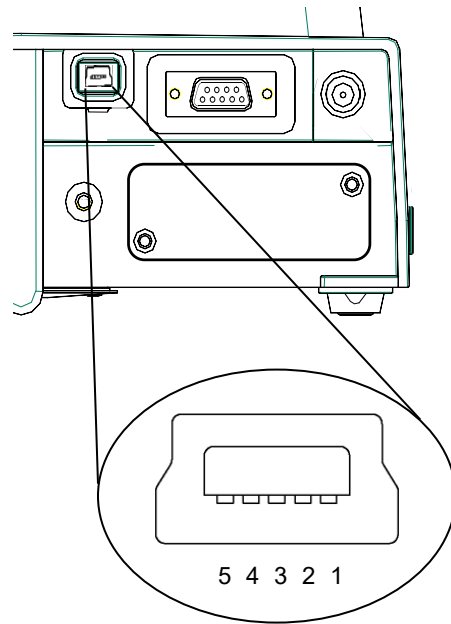

3. Connecting Peripheral Devices

It is possible to connect the balance to peripheral devices, PCs, PLCs, etc. by using the RS-232C connector and the USB mini B connector which are provided as standard with the balance.

3-1. Cables needed to connect to peripheral devices

Connection cables for peripheral devices and interfaces are as follows.

Table 3-1-1. Connection cables for peripheral interface

Name	Model	Communication interface	Connection cables		Note
			Standard / Option	Standard / Option	
Mini printer	AD-8126	RS-232C or Extension RS-232C	[Standard] RS-232C cable included with the printer	AX-KO1710-200	*5
Multi-function printer	AD-8127			AX-KO2741-100	*1 , *5
Remote display	AD-8920A	RS-232C or Extension RS-232C	[Standard] Communication cable included with remote display or remote controller	AX-KO3412-100	*2 , *5
Remote controller	AD-8922A			AX-KO2466-200	*2 , *5
Extension controller for weighing lines	AD-8923BCD		[Option]	AX-KO2466-200	*5
	AD-8923CC				
PLC		[Option]		*3	
PC		RS-232C or Extension RS-232C	[Option]		*4 , *5
		USB	[Standard] USB cable included with the balance	AX-KO5465-180	

Note

- *1 When using the AD-8529PR-W (Bluetooth converter) sold separately, the RS-232C cable included with the printer is not used.
- *2 There is also a 5m / 10m cable sold separately.
- *3 Check the interface specifications of the GX-A / GF-A / GX-AWP / GF-AWP / GX-M / GF-M and the PLC used and prepare a compatible cable.
- *4 The balance can be connected to a PC using AX-USB-9P, AD-8529PC-W, AD-1688 and AD-8527.
The connection cable included with these products can be used for data transfer.
- *5 When using the GX-AWP / GF-AWP / GX-M / GF-M series as having dustproof and drip-proof performance, please attach a waterproof RS-232C cable (AX-KO2737-500EX).

3-2. About data output method

Change the function of the balance to make the operation method that which is suitable for use with the balance. For details on the function table, refer to "10. Function Table" in the GX-A / GF-A / GX-AE / GX-AWP / GF-AWP / GX-M / GF-M Series Instruction Manual.

- 1) The weighing data output method using the RS-232C/extension RS-232C / USB interface can be specified in the "Data output mode (*Prt*)".

Table 3-2-1. Data output mode

Class	Item	Parameter	Description	
<i>dout</i>	<i>Prt</i> Data output mode	0	Key mode	Outputs if stable when <input type="button" value="PRINT"/> key is pressed.
		1	Auto print A mode	Automatically outputs after stabilization (zero is the standard).
		2	Auto print B mode	Automatically outputs after stabilization (based on previous stable value).
		3	Stream mode	Continuously outputs
		4	Key mode B mode	Immediately outputs regardless of being stable or unstable when <input type="button" value="PRINT"/> key is pressed.
		5	Key mode C mode	When <input type="button" value="PRINT"/> key is pressed, outputs immediately if stable, outputs after stabilization if unstable.
		6	Interval mode	Starts output with <input type="button" value="PRINT"/> key, outputs at time of setting.

2) Precautions when connecting multiple peripheral devices at the same time.

Peripheral devices such as the remote display, remote controller, and extension controller for weighing lines in Table 3-1-1 display the weighing value in real time. So the balance is normally operated in a continuous output mode (stream mode).

Conversely, if the balance is set to stream mode, it may be difficult to use peripheral device at the same time. The function " *ModE* " is enable RS-232C and expansion RS-232C to operate exceptionally for according to the connected peripheral device.

Table. 3-2-2 Function of the " *ModE* "

Class	Item	Parameter		Description	
				Data output mode	Data format
<i>5 iF</i>	<i>ModE</i> Devices connected to RS-232C	0	PC, PLC, etc.	Follow <i>dout Prt</i> setting	Follow <i>5 iF tYPE</i> setting
		1	Printer	Follow <i>dout Prt</i> setting	Follow <i>5 iF tYPE</i> setting (A&D standard, DP only selectable)
		2	Remote display, etc.	Regardless of <i>dout Prt</i> enter stream mode	Regardless of <i>5 iF tYPE</i> output with A&D standard format *1
<i>oP-5 iF</i>	<i>ModE</i> Devices connected to additional RS-232C	0	PC, PLC, etc.	Follow <i>dout Prt</i> setting	Follow <i>oP-5 iF tYPE</i> setting
		1	Printer	Follow <i>dout Prt</i> setting	Follow <i>oP-5 iF tYPE</i> setting (A&D standard, DP only selectable)
		2	Remote display, etc.	Regardless of <i>dout Prt</i> enter stream mode	Regardless of <i>oP-5 iF tYPE</i> output with A&D standard format *1

*1 Only the weighing value is output continuously.
Date, time (*Prt/5-td*), ID number (*Prt/5-id*) are not added, and data output interval (*PUSE*), auto feed (*Rt-F*), GLP output (*inFa*) functions cannot be used.

3-3. Specific examples when connecting multiple peripheral devices at the same time

[1] Connecting to a printer and PC

Example of use) Outputs the weighing value to the printer and imports the weighing value at the same time.

Table 3-3-1. Example of simultaneous connection settings [1] "Printer and PC"

Connection method		Function compatible with connection interface / connected device			
Interface	Connected device	Class	Item	Parameter	Contents
(Common setting)		<i>dout</i>	<i>Prt</i>	0-6	Select the data output mode suitable for the usage / settings of the printer / PC *1
RS-232C	Printer	<i>Sif</i>	<i>ModE</i>	1	Select the data output format suitable for the settings / usage of the printer (A&D standard format, DP format)
			<i>TYPE</i>	0,1	
USB	PC	<i>USB</i>	<i>U-LP</i>	0-4	Select an output format that is easy for your PC to handle.
Expansion RS-232C	[None]				

*1 The data output mode is common to the printer and PC.

The balance printer is the mini printer AD8126 or the multi printer AD8127.

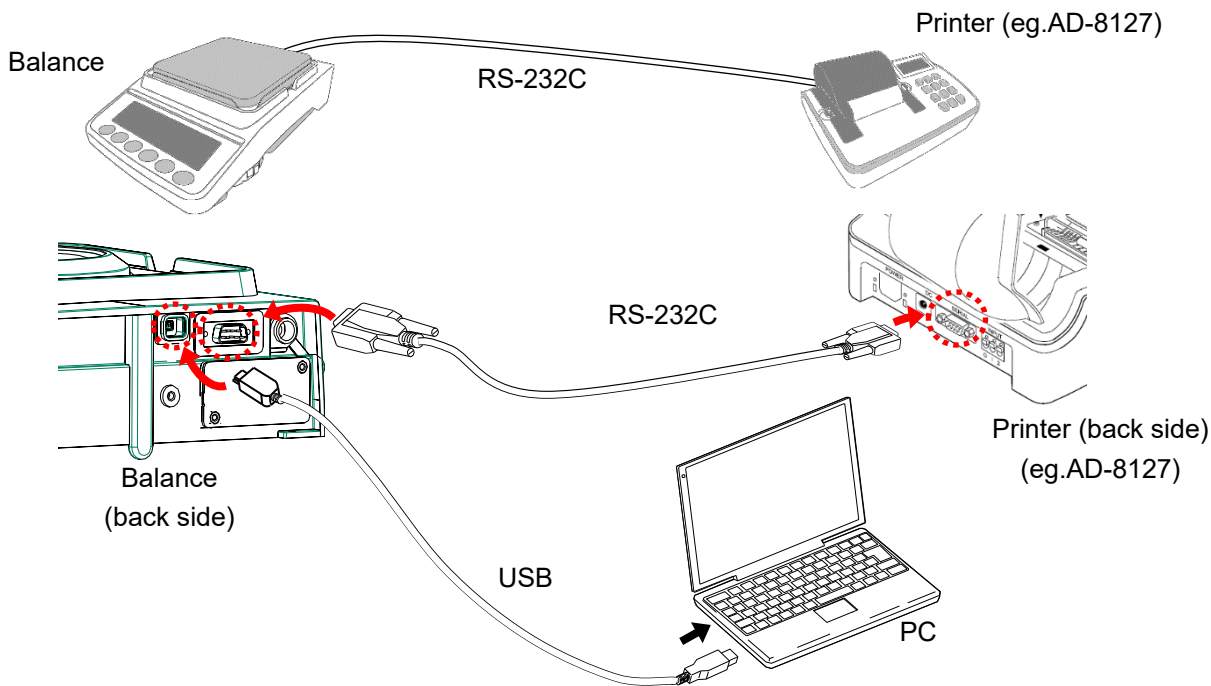

If only the balance is connected to the PC, it can also be connected using a USB cable or RS-232C cable.

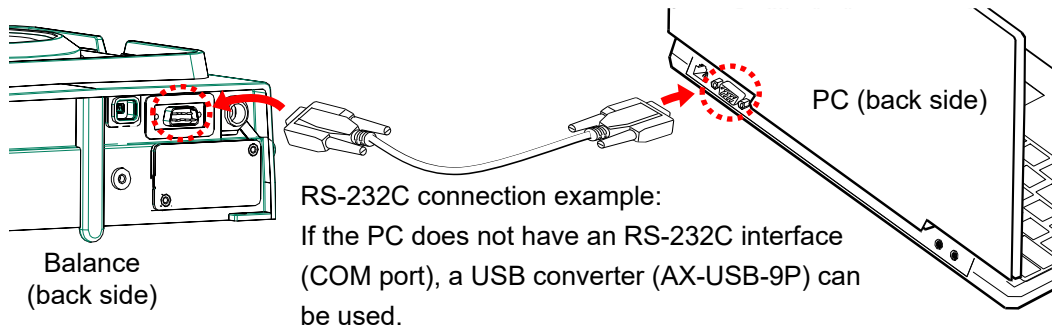

RS-232C connection example:
If the PC does not have an RS-232C interface (COM port), a USB converter (AX-USB-9P) can be used.

[2] Connection between printer and remote display

Example of use) Print the weighing value on the printer while displaying the measured value on the remote display.

Table 3-3-2 Example of simultaneous connection settings [2] "Printer and external display, etc."

Connection method		Function compatible with connection interface / connected device			
Interface	Connected device	Class	Item	Parameter	Contents
RS-232C	Printer	<i>dout</i>	<i>Prt</i>	0-6	Select the data output mode suitable for the settings / usage of the printer
		<i>S iF</i>	<i>ModE</i>	1	Select the data output format suitable for the settings / usage of the printer (A&D standard format, DP format)
			<i>tYPE</i>	0,1	
Standard USB	[None]				
Expansion RS-232C	Remote display	<i>oP-S iF</i>	<i>ModE</i>	2	Weighing values are continuously output to the remote display in A&D standard format.

Connect a remote display dedicated to the balance when checking the weighing value or performing key operations at a distance from the balance.

The remote display dedicated to a remote is the external display AD-8920A (display only) and a remote controller AD-8922A.

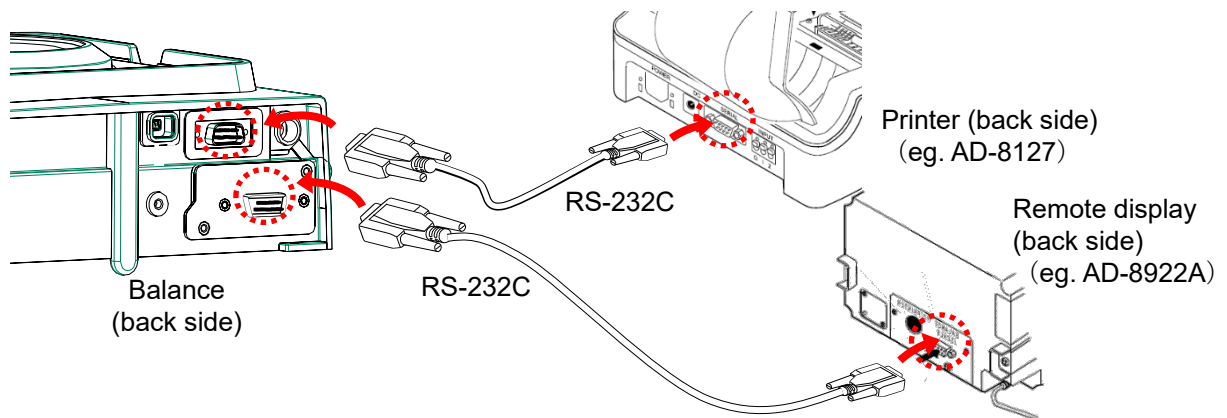
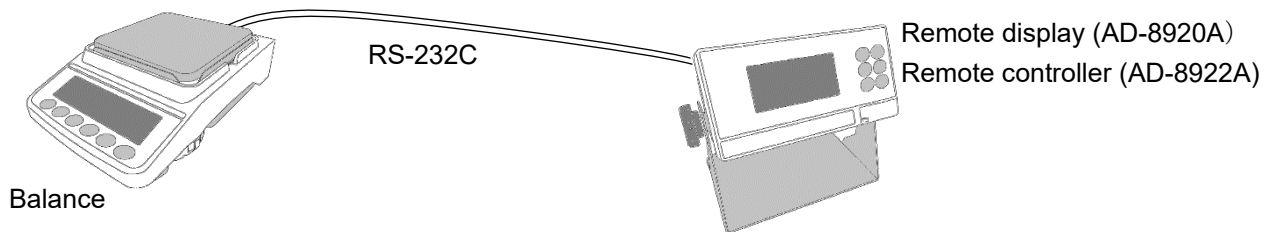

It is also possible to connect a printer to a remote controller (AD-8922A). For details, please refer to the AD-8922A instruction manual.

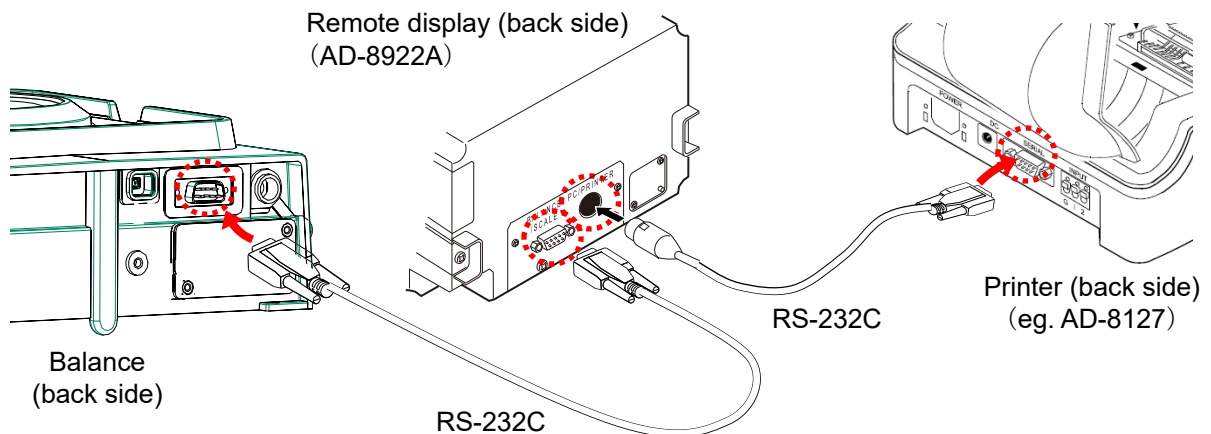

[3] Connection between remote display and PC

Example of use) Logging the weighing value on the PC while displaying the weighing value on the remote display.

Table 3-3-3 Example of simultaneous connection settings [3] [External display and PC]

Connection method		Function compatible with connection interface / connected device			
Interface	Connected device	Class	Item	Parameter	Contents
RS-232C	Remote display	<i>Sif</i>	<i>ModE</i>	2	Weighing values are continuously output to the remote display in A&D standard format.
USB	PC	<i>dout</i>	<i>Prt</i>	0-6	Select data output mode suitable for PC logging method.
		<i>USB</i>	<i>U-EP</i>	0-4	Select an output format that is easy for your PC to handle.
Expansion RS-232C	[None]				

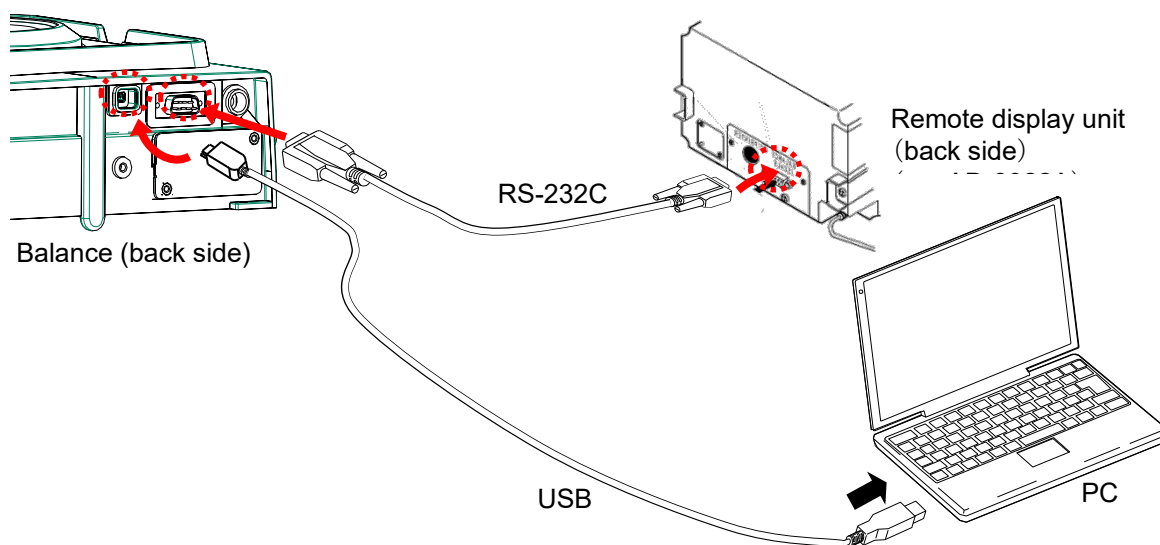

[4] Connection between remote display or remote controller and PLC (GX-A / GF-A / GX-AWP / GF-AWP)

Example of use) Reading the weighing value with the PLC while displaying the weighing value with the remote controller.

Table 3-3-4 Example of simultaneous connection settings [4] "Remote display or remote controller and PLC"

Connection method		Function compatible with connection interface / connected device			
Interface	Connected device	Class	Item	Parameter	Contents
RS-232C	Remote controller	5, iF	ModE	2	Weighing values are continuously output to the remote controller in A&D standard format.
USB	[None]				
Expansion RS-232C	PLC	dout	PrE	0-6	Select data output mode suitable for the PLC settings / usage.
		oP-5, iF	ModE TYPE	0 0-5	Select an output format that is easy for your PLC to handle.

When connecting [Remote display unit or Remote controller] and [PLC] to the balance, each device must be connected via the RS-232C interface. Please connect the remote display and remote controller with the RS-232C, install the dedicated option GXA-03 (extension RS-232C) on the balance, and connect the PLC with the extension RS-232C of GXA-03.

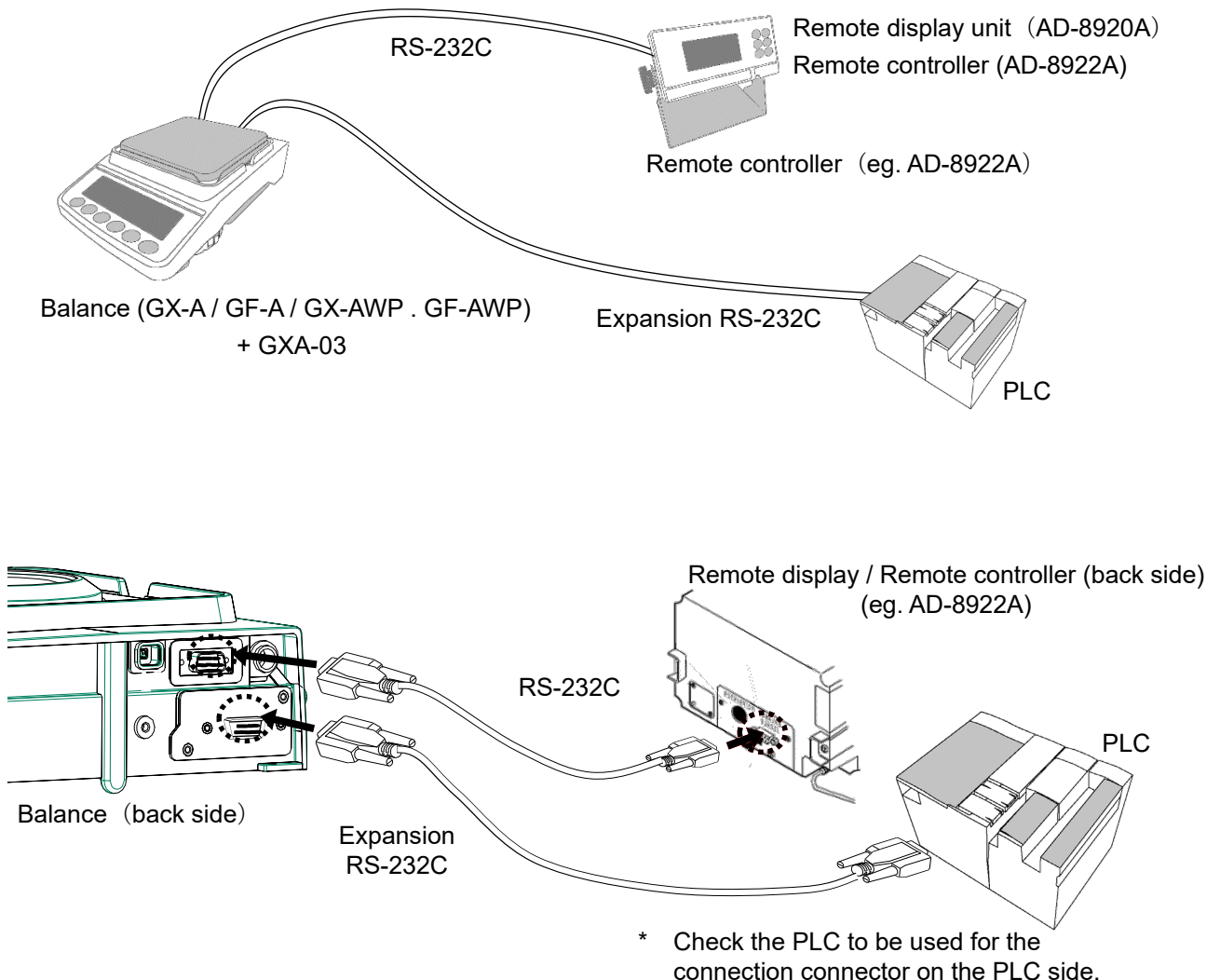

4. Printing Weighing Values to the Printer

The following shows examples of the balance's function and printer settings corresponding to the type of printer used and the printing method such as weighing value.

4-1. In case of AD-8127

1) When printing only weighing value

Table 4-1-1 Balance common settings when printing only weighing values on the AD-8127

Class	Item	Parameter	Contents
S i F	Mode	1	Printer connection
	TYPE	0	A&D standard format

Table 4-1-2 Settings when printing only weighing values on the AD-8127

Weighing value printing method	Function of the balance		AD-8127 Function	
	dout / Prt	Contents	PRN MODE	Contents
Print the weighing value when the <input type="checkbox"/> PRINT key on the balance is pressed.	0	Key mode (when stable)	EXT.KEY	External key printing mode
	4	Key mode B mode (immediate) *1		
	5	Key mode C mode (After stable)		
Automatically print the weighing value when the weighing value changes.	1	Auto print A mode (zero standard)		
	2	Auto print B mode (Previous stability criteria)		
Print the weighing value at regular intervals.	6	Interval mode *1		
Print the weighing value when the printer's [<input type="checkbox"/> +0PRINT] key is pressed.	3	Stream mode *1	MANUAL	Manual printing mode
Print the weighing value in chart format.	3	Stream mode *1	CHART	Chart printing mode

*1 Unstable data is also output.

To set to the AD-8127 to a mode other than dump print mode and print unstable data too, change the function of the AD-8127 to "Setting to print unstable data (US PRN/PRINT)"

2) When adding date/time or ID number, etc. to the weighing value by the clock function of the balance.

Table 4-1-3. Common settings for the balance when printing with information in addition to the weighing value added to the AD-8127

Class	Item	Parameter	Contents
5 IF	ModE	1	Printer setting
	TYPE	1	DP format

Table 4-1-3. Common settings for the balance when printing with information in addition to the weighing value added to the AD-8127

Weighing value printing method	Function of the balance		AD-8127 Function	
	<i>dout</i> <i>/ Prt</i>	Contents	PRN MODE	Contents
Print the weighing value when the [PRINT] key on the balance is pressed.	0	Key mode (when stable)	DUMP	Dump print mode
	4	Key mode B mode (immediate)		
	5	Key mode C mode (After stable)		
Automatically print the weighing value when the weighing value changes.	1	Auto print A mode (zero standard)		
	2	Auto print B mode (Previous stability criteria)		
Print the weighing value at regular intervals.	6	Interval mode		

- Printing with printer keys and chart format printing are not possible.

3) When outputting information other than weighing values

When printing sensitivity adjustment / calibration test maintenance records (GLP output), or when the balance outputs statistical calculation results calculated on the balance, change the printer to dump print mode.

Table 4-1-5. AD-8127 settings when printing information other than weighing values on the AD-8127.

AD-8127 Function	
PRN MODE	Contents / usage
DUMP	Dump print mode

- Switching the print mode (PRN MODE) of the AD-8127
When pressing and holding the [ENT_{SAVE}] key on the printer, it is possible to switch between EXT.KEY (external key mode) and DUMP (dump printing mode) without entering the AD-8127 function settings.

4-2. In case of AD-8126

The AD-8126 prints the received data as is (dump printer).

1) Common settings

Table 4-2-1. Common settings for the balance when connecting to the AD-8126.

Class	Item	Parameter	Contents
S iF	Mode	1	Printer connection
	TYPE	1	DP format

2) Balance settings corresponding to the weighing value printing method

Table 4-2-2. Settings for printing weighing value on the AD-8126

Weighing value printing method	Balance function	
	Print / Print	Contents
Print the weighing value when the PRINT key on the balance is pressed.	0	Key mode (when stable)
	4	Key mode B mode (immediate)
	5	Key mode C mode (After stable)
Automatically print the weighing value when the weighing value changes.	1	Auto print A mode (zero standard)
	2	Auto print B mode (Previous stability criteria)
Print the weighing value at regular intervals.	6	Interval mode

- With the AD-8126, printing with the printer key and chart printing are not possible.

5. Connecting to a PC

5-1. Quick USB mode

Quick USB mode is a function used to connect the balance with the PC using a USB cable to directly input the output data of the balance into PC software such as Excel or Word. Windows 7 or later is supported.

Since the balance uses a standard Windows driver (HID), no installation of a special driver is necessary and communication is possible just by connecting the balance to a PC.

Caution

- ❑ Quick USB is a one-way communication from the balance to the PC. It is not possible to send control commands from the PC to the balance.
- ❑ Turn off the PC's screen saver and stand-by modes.
- ❑ Do not use quick USB when the output mode of the balance is set to stream mode.
As stream mode continuously outputs weighing data to the PC from the balance, irregular operation may occur on the PC.
- ❑ For GX-M / GF-M series and GX-AE / GX-A/GF-A / GX-AWP / GF-AWP software version 1.211 or later, Quick USB ALL and Quick USB NU in UF_{nc} of the function table are integrated.
The configuration will be changed as follows.

GX-A / GF-A Software version 1.200		GX-M / GF-M and GX-AE / GX-A / GF-A / GX-AWP / GF-AWP Software version 1.211 or later	
$UF_{nc} \ 0$	Quick USB ALL	$UF_{nc} \ 0$	Quick USB
$UF_{nc} \ 1$	Quick USB NU	$UF_{nc} \ 1$	Bi-directional USB virtual COM
$UF_{nc} \ 2$	Bi-directional USB virtual COM		None

- ❑ Refer to section "12. Checking the Software Version of the Balance" for how to confirm the software version of the balance.

About the output format for USB

- ❑ When using USB, the output format is selected at function $U-tP$.
In GX-AE / GX-A/GF-A / GX-AWP / GF-AWP software version 1.211 or later, $U-tP \ 4$ (NU2 format) is added to the function.

Function	Output format	Example
$U-tP \ 0$	A&D standard format	S T , + 0 0 1 2 3 . 4 5 _ _ g CR LF
$U-tP \ 1$	NU format	+ 0 0 1 2 3 . 4 5 CR LF
$U-tP \ 2$	CSV format	S T , + 0 0 1 2 3 . 4 5 , _ _ g CR LF
$U-tP \ 3$	TAB format	S T TAB + 0 0 1 2 3 . 4 5 TAB _ _ g CR LF
$U-tP \ 4$	NU2 format	1 2 3 . 4 5 CR LF

_ means space.

CR means ASCII: 0Dh

LF means ASCII: 0Ah

TAB means ASCII: 09h

- ❑ When output is the same as quick USB NU in GX-AE / GX-A/GF-A software version 1.200, set to $U-tP \ 1$ (NU format) or $U-tP \ 4$ (NU2 format).
- ❑ Refer to section "6-2. Weighing data format" for details of output format.

Operating instructions (when sending weighing data using the balance's **PRINT** key)

1. Set the function UF_{nc} parameter is to $\bar{1}$ (Quick USB).
2. Connect the balance to a PC with the supplied USB cable.
3. When connecting for the first time, the PC will automatically start installing the driver.
4. Start up PC software (Excel, etc.) for transmitting the weighing data.
5. Set the keyboard input mode to half-width. It is not entered correctly in full-pitch setting.
6. Move the cursor to the place you want to input the weighing data.
7. When you press the **PRINT** key on the balance, weighing data will be transmitted from the balance and input at the location of the cursor.
8. Disconnect the USB cable when finished.

5-2. Virtual COM mode

Virtual COM mode is a function used to connect the balance with the supplied USB cable and create a COM port on the PC side for bi-directional communication. Windows 7 or later is supported. Except for Windows 10, when using for the first time, you need to install a special driver on the PC.

For details on how to install the driver, please refer to "How to install the Virtual COM mode driver" for the GX-A / GF-A series USB interface on our website (<https://www.aandd.jp>).

When selecting a COM port with Win CT data communication software, the same data communication as RS-232C will be available.

With Virtual COM mode, no settings for baud rate, data bits, parity and stop bits are necessary.

Caution

- It may take time to install the Virtual COM mode driver for the first time.

About function

- When using Virtual COM mode, please set the balance's function UF_{nc} to bi-directional USB virtual COM.

For GX-AE / GX-A GF-A, the setting values differ depending on the software version.

Software version 1.200		Software version 1.211 or later	
UF_{nc} $\bar{2}$	COMBi-directional USB virtual COM	UF_{nc} $\bar{1}$	Bi-directional USB virtual COM

5-3. RS-232C

The RS-232C interface of the balance is the DCE (Data Communication Equipment) that can be connected to a PC. The RS-232C cable used for connection is the straight type. If there is no RS-232C connector on the PC, please connect in USB Virtual COM mode.

5-4. WinCT data transmission software (USB Virtual COM mode or RS-232C)

When a PC is connected through a USB connection in virtual COM mode or with a RS-232C cable, weighing data can be easily received by the PC with the use of the WinCT data communication software for Windows. WinCT can be downloaded from our website (<https://www.aandd.jp>). Please refer to "Setup manual" and "Operation manual" for WinCT on our website (<https://www.aandd.jp>) for installation and setup.

There are 3 applications in WinCT : RsCom, RsKey and RsWeight.

RsCom

- You can control the balance by sending a command to it.
- Received data can be displayed and saved as a text file (.txt).
- By executing the software multiple times, you can communicate with multiple balances.
- It can be executed simultaneously with other applications. (Does not exclusively occupy the PC)
- GLP output data can also be received from the balance.

RsKey

- Weighing data from the balance can be input directly into another applications.
- If input by keyboard (e.g. with Word or Excel) is possible, the type of application does not matter.
- GLP output data from the balance can also be input.
- The PC can be made into an external display for the balance through the use of the test display function.

RsWeight

- Received data can be graphed in real time.
- Parameters of received data such as maximum value, minimum value, average value, standard deviation, coefficient of variation, etc. can be calculated and displayed.

5-5. Notes when using quick USB

If software version 1.211 is used, the data may not be output from the USB terminal when you connect a USB cable during weighing to output by quick USB.

In this case, reset the balance by the following steps.

Instructions when data cannot be output with quick USB

1. Unplug the AC adapter from the balance.

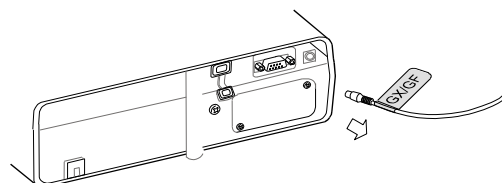

2. Connect the balance and the PC via a USB cable.

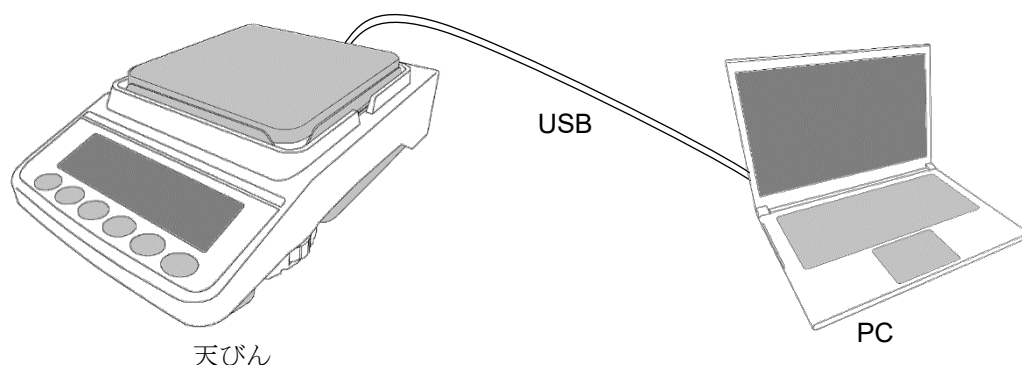

3. Plug the AC adapter into the balance.

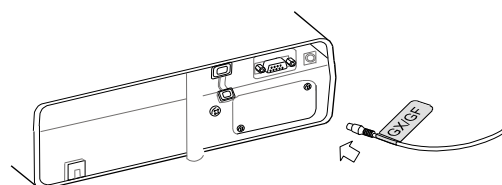

4. The **LEVEL** display will blink and **usb** will light up in the upper left.

* GX-M/GF-M series does not have a **LEVEL** display.

5. Press the **ON:OFF** key to display weighing mode.

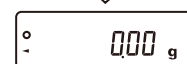

6. Press the **PRINT** key on the balance to output the data to the PC.

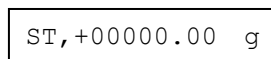

6. Data output

6-1. Data output mode

As for the balance's data output timing, it can be changed with the function *Prt* (data output mode).

Key mode

Function *dout Prt 0*

If the **PRINT** key is pressed when the stable value mark is displayed, the weighing value will be output once. At that time the displayed weighing value will blink once to indicate that it had been output.

Auto print A mode

Function *dout Prt 1*

When the weighing value exceeds the range specified by the *RP-P* (auto print polarity) and the *RP-b* (auto print width) from the standard "zero display" and the stable value mark is on, the weighing value will be output once. Also, if the **PRINT** key is pressed while the stable value mark is on, the weighing value will be output once.

At that time the displayed weighing value will blink once to indicate that it had been output.

Related function

<i>dout RP-P</i>	Auto print polarity
<i>dout RP-b</i>	Auto print width

Auto print B mode

Function *dout Prt 2*

When the weighing value exceeds the range specified by the *RP-P* (auto print polarity) and the *RP-b* (auto print width) from the standard "value previously displayed with a stable value mark" and the stable value mark is on, the weighing value will be output once. Also, if the **PRINT** key is pressed while the stable value mark is on, the weighing value will be output once. At that time the displayed weighing value will blink once to indicate that it had been output.

Related function

<i>dout RP-P</i>	Auto print polarity
<i>dout RP-b</i>	Auto print width

Stream mode

Function *dout Prt 3*

Regardless of the presence or absence of the stable value mark, weighing value will be output for each *SPd* (display refresh rate). When the *SPd* parameter is set to 0, the output is at approximately 5.21 Hz.

Related function

<i>bRSFnc SPd</i>	Display refresh rate
<i>SiF bPS</i>	Baud rate

Caution

- Depending on the display refresh rate and the baud rate, all data may not be transmitted unless the baud rate is increased.

Key mode B mode

Function *dout Prt 4*

Regardless of the presence or absence of the stable value mark, when the PRINT key is pressed, the weighing value will be output once.

At that time the displayed weighing value will blink once to indicate that it had been output.

Key mode C mode

Function *dout Prt 5*

When the PRINT key is pressed and the stable value mark is displayed, the weighing value will be output once. In case the stable value mark is not displayed, the weighing value will be output once the stable value mark is displayed next time.

At that time the displayed weighing value will blink once to indicate that it had been output.

Interval mode

Function *dout Prt 6*

Regardless of the state of the stable value mark, weighing value will be output at an interval of the *int* (interval time). By pressing the PRINT key, data output is started and stopped by pressing it again during the data output.

Related function

dout int Interval time

5 iF bPS Baud rate

Caution

- **Depending on the interval time and the baud rate, all data may not be transmitted unless the baud rate is increased.**

6-2. Weighing data format

As for the weighing data format, for USB it can be changed by the USB interface item *U-tP* (USB data format) and for RS-232C – by the Serial interface item *tYPE* (data format).

A&D standard format **RS-232C connection: Function** *SIF tYPE 0*
USB setting: Function *USB U-tP 0*

- ❑ This is the standard format for sending data to peripheral devices.
- ❑ Consists of 15 characters (excluding the terminator).
- ❑ The condition of the data is indicated with a 2-character header.
- ❑ The data is padded with polarity and zeros (filling the data's higher order's surplus part with zeros).
- ❑ If the data is zero, the polarity is positive.
- ❑ The unit consists of three characters.

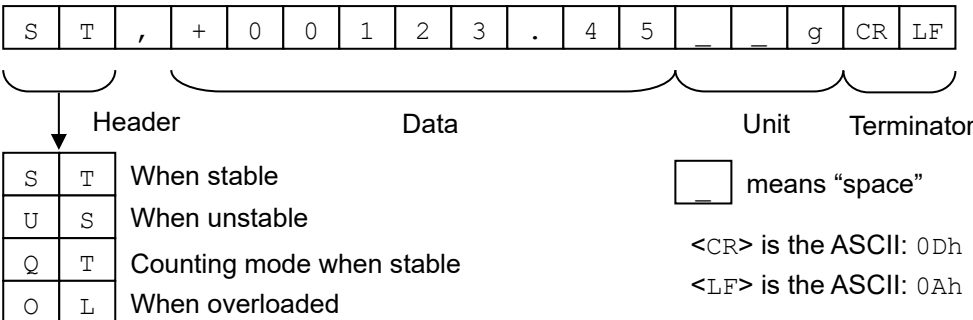

- ❑ The external key print mode of the AD-8127 multi-function printer is as follows when the A&D standard format is received.:

WT 123.45 g

DP format (Dump print) **RS-232C connection: Function** *SIF tYPE 1*
USB connection: No function

- ❑ This format is suitable for dump printing.
- ❑ Consists of 16 characters (excluding the terminator).
- ❑ The condition of the data is indicated with a 2-character header.
- ❑ The polarity sign is added right before the data if the data is not overloaded or zero.
- ❑ The data is zero-suppressed (leading zeros are replaced with spaces).
- ❑ The unit consists of three characters.

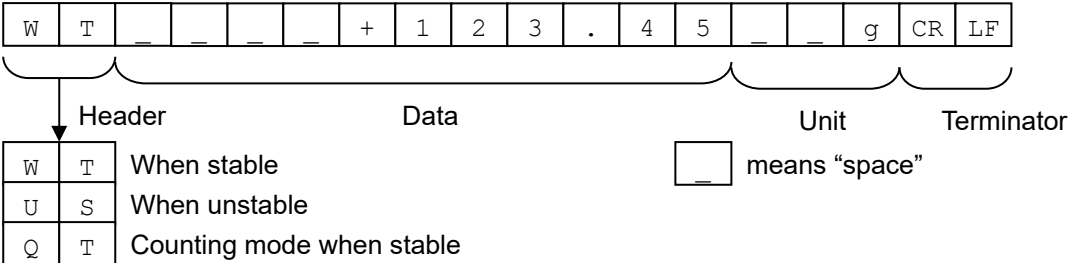

KF format

RS-232C connection: Function SIF TYPE 2

USB connection: No function

This is the Karl-Fischer moisture meter format.

- Consists of 14 characters (excluding the terminator).
- Has no header characters.
- The polarity sign (1 character) is placed before the data if the data is not overloaded or zero.
- The data is zero-suppressed (leading zeros are replaced with spaces).
- When stable, the unit is output. When not stable, the unit is not output.

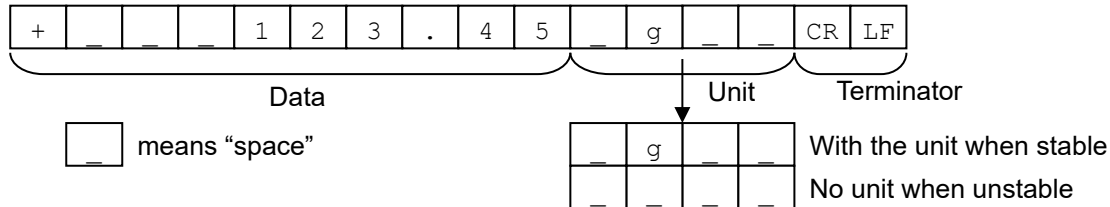

MT format

RS-232C connection: Function SIF TYPE 3

USB connection: No function

- Used when connecting to devices manufactured by other companies. However, there is no guarantee of compatibility.
- The length of data depends on the length of the unit
- Has a 2-character header.
- The data is zero-suppressed (leading zeros are replaced with spaces).

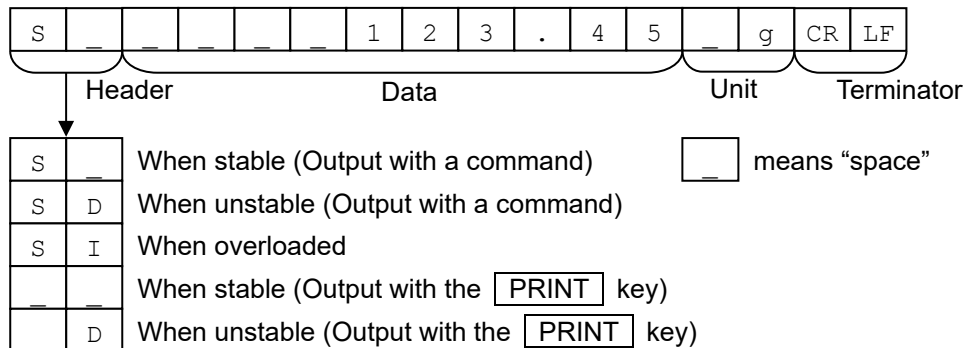

NU format

RS-232C connection: Function SIF TYPE 4

USB setting: Function USB U-TP 1

- This format outputs only numerical data.
- Consists of 9 characters (excluding the terminator).
- The data is padded with polarity and zeros (filling the data's higher order's surplus part with zeros).
- If the data is zero, the polarity is positive.

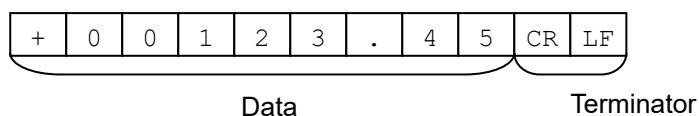

CSV format

RS-232C connection: Function *S, F tYPE* *5*

USB setting: Function *USB U-tP* *2*

- Separates the data of A&D standard format and the unit by a comma (,).
- Outputs the unit even when the data is overloaded.
- When the decimal point is set to comma (,), semicolon (;) will be used as the separator.

S	T	,	+	0	0	1	2	3	.	4	5	,	_	_	g	CR	LF
---	---	---	---	---	---	---	---	---	---	---	---	---	---	---	---	----	----

- When other data is added to the weighing value, all data will be displayed in one line.
- The display sample will be as follows if the ID number, data number, date and time are added.

SAMPLE-0123-4, No, 012, 2017/07/01, 12:34:56, ST, +00123.45, g																	
ID number				Data number			Date			Time			Weighing data				

TAB format

RS-232C connection: *1 Function *S, F tYPE* *6*

USB setting: Function *USB U-tP* *3*

- This is a format, in which the separator of the CSV format is changed from comma to TAB.

S	T	TAB	+	0	0	1	2	3	.	4	5	TAB	_	_	g	CR	LF
---	---	-----	---	---	---	---	---	---	---	---	---	-----	---	---	---	----	----

<TAB> is the ASCII : 09h

*1 GX-A / GF-A / GX-AE software version 1.00 to 1.400 : No function

NU2 format

RS-232C connection: *1 Function *S, F tYPE* *7*

USB setting: Function *USB U-tP* *4*

- Weighing values are output only as numerical data.
- If the data is zero or positive, polarity is not added.

1	2	3	.	4	5	CR	LF
---	---	---	---	---	---	----	----

Data

Terminator

*2 GX-A / GF-A / GX-AE software version 1.00 to 1.400 : No function

6-3. Output examples of weighing data format

When stable



A&D	S	T	,	+	0	3	1	4	2	.	0	6	_	_	g	CR	LF	
DP	W	T	_	_	_	+	3	1	4	2	.	0	6	_	_	g	CR	LF
KF	+	_	_	3	1	4	2	.	0	6	_	g	_	_	CR	LF		
MT	S	_	_	_	3	1	4	2	.	0	6	_	g	CR	LF			
NU	+	0	3	1	4	2	.	0	6	CR	LF							
NU2	3	1	4	2	.	0	6	CR	LF									

When unstable



A&D	U	S	,	-	0	0	2	9	5	.	8	7	_	_	g	CR	LF
DP	U	S	_	_	_	-	2	9	5	.	8	7	_	_	g	CR	LF
KF	-	_	_	_	2	9	5	.	8	7	_	_	_	_	CR	LF	
MT	S	D	_	_	-	2	9	5	.	8	7	_	g	CR	LF		
NU	-	0	0	2	9	5	.	8	7	CR	LF						
NU2	-	2	9	5	.	8	7	CR	LF								

When overloaded
(plus)



A&D	O	L	,	+	9	9	9	9	9	9	E	+	1	9	CR	LF
DP	_	_	_	_	_	_	_	E	_	_	_	_	_	_	CR	LF
KF	_	_	_	_	_	H	_	_	_	_	_	_	_	_	CR	LF
MT	S	I	+	CR	LF											
NU	+	9	9	9	9	9	9	9	9	CR	LF					
NU2	+	9	9	9	9	9	9	9	9	CR	LF					

When overloaded
(minus)

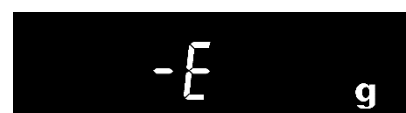

A&D	O	L	,	-	9	9	9	9	9	9	E	+	1	9	CR	LF
DP	_	_	_	_	_	-	E	_	_	_	_	_	_	_	CR	LF
KF	_	_	_	_	-	L	_	_	_	_	_	_	_	_	CR	LF
MT	S	I	-	CR	LF											
NU	-	9	9	9	9	9	9	9	9	CR	LF					
NU2	-	9	9	9	9	9	9	9	9	CR	LF					

Units

		A&D	DP	KF	MT
g	g	_ _ g	_ _ g	_ g _ _	_ g
mg	mg	_ m g	_ m g	_ m g _	_ m g
Counting mode	<i>PCS</i>	_ P C	_ P C	_ p c s	_ P C S
Percent mode	%	_ _ %	_ _ %	_ % _ _	_ %
Ounce (Avoir)	<i>oz</i>	_ o z	_ o z	_ o z _	_ o z
Pound	<i>lb</i>	_ l b	_ l b	_ l b _	_ l b
Pound Ounce	<i>LOZ</i>	_ o z	_ o z	_ o z _	_ o z
Troy Ounce	<i>ozt</i>	o z t	o z t	_ o z t	_ o z t
Metric Carat	<i>ct</i>	_ c t	_ c t	_ c t _	_ c t
Momme	<i>mom</i>	m o m	m o m	_ m o m	_ m o
Pennyweight	<i>dwt</i>	d w t	d w t	_ d w t	_ d w t
Grain	<i>GN</i>	_ G N	_ G N	_ g r _	_ G N
Tael (HK general, Singapore)	<i>TL</i>	_ t l	_ t l	_ t l s	_ t l
Tael (HK, jewelry)	<i>TL</i>	_ t l	_ t l	_ t l h	_ t l
Tael (Taiwan)	<i>TL</i>	_ t l	_ t l	_ t l t	_ t l
Tael (China)	<i>TL</i>	_ t l	_ t l	_ t l c	_ t l
Tola (India)	<i>LOL</i>	_ _ t	_ _ t	_ t o l	_ t
Messghal	<i>MES</i>	m e s	m e s	_ M S _	_ m
Density	<i>DS</i>	_ D S	_ D S	_ D S _	_ D
Multi	<i>MLT</i>	M L T	M L T	_ M L T	_ M L T

_ Space, ASCII 20h

Note

When "Pound Ounce" is selected, the data is output with the unit of ounce (oz).

6-4. Other data formats

In addition to weighing data, other data can be added. Switch each function on / off as necessary.

Data number

Function *dout d-no 1*

- When the data memory function is used, the data number is output.
- Consists of 6 characters (excluding the terminator).
- When the NU or NU2 format is selected with quick USB mode, " . " and numbers are output.

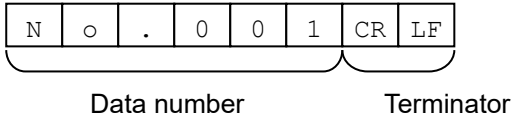

Quick USB connection (When outputting numerical values only):

Function *USB UFnC 0 and U-tP 1 or 4*

(GX-A / GF-A / GX-AE software version 1.00 to 1.200 : Function *USB UFnC 1*)

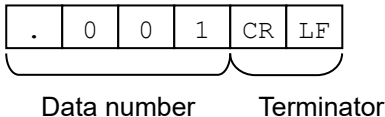

ID number

Function *dout 5-id 1*

- The ID number stored in the balance is output.
- Consists of 13 characters (excluding the terminator).
- When the NU or NU2 format is selected with quick USB mode, " - " and numbers are output.

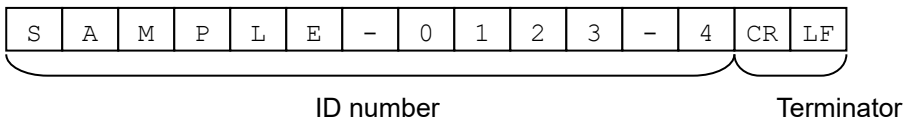

Quick USB connection (When outputting numerical values only):

Function *USB UFnC 0 and U-tP 1 or 4*

(GX-A / GF-A / GX-AE software version 1.00 to 1.200 : Function *USB UFnC 1*)

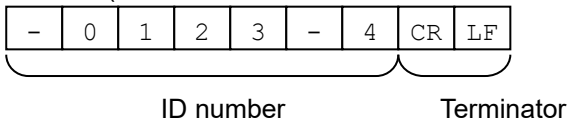

Date

Function *dout 5-td 2 or 3*

The date is output from the clock data of the balance.

- The order of YYYY/MM/DD can be changed in settings.
- Consists of 10 characters (excluding the terminator).
- When the NU or NU2 format is selected with quick USB mode, "." is output instead of "/".

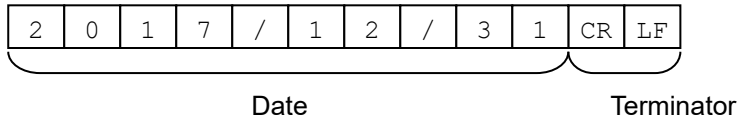

Quick USB connection (When outputting numerical values only):

Function *USB UFunc 0 and U-EP 1 or 4*

(GX-A / GF-A / GX-AE software version 1.00 to 1.200 : Function *USB UFunc 1*)

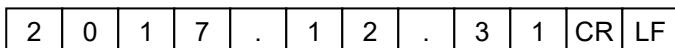

Time

Function *dout 5-td 1 or 3*

- The time is output from the clock data of the balance.
- 24-hour format.
- Consists of 8 characters (excluding the terminator).
- When the NU or NU2 format is selected with quick USB mode, "." is output instead of ":".

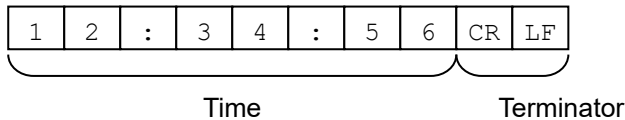

Quick USB connection (When outputting numerical values only):

Function *USB UFunc 0 and U-EP 1 or 4*

(GX-A / GF-A / GX-AE software version 1.00 to 1.200 : Function *USB UFunc 1*)

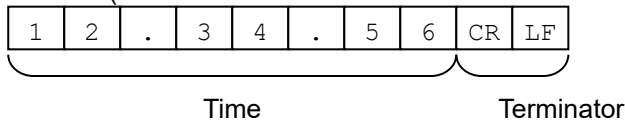

7. Commands

By sending a specified command from a PC or a PLC to the balance, you can control the balance such as requesting weighing data, manipulating various keys and changing the setting value. Add a terminator (<CR> <LF> or <CR>) to the command string by setting serial interface item *[rLF]* when you send a command to the balance.

7-1. Control commands

Commands to query weighing data

Command string	Function
Q	Requests the weighing data immediately
RW	Requests the weighing data immediately
SI	Requests the weighing data immediately
S	Requests the weighing data when stabilized.
<ESC>P	Requests the weighing data when stabilized.
SIR	Requests the weighing data continuously. (Stream output)
C	Cancels the S, <ESC>P or SIR command.

- The Q, RW and SI commands behave the same.
- The S and <ESC>P commands behave the same.
- <ESC>:Escape code, ASCII : 1Bh

Key control commands

Command string	Function
P	Same as the <input type="button" value="ON:OFF"/> key
ON	Turns the display on.
OFF	Turns the display off.
CAL	Same as the <input type="button" value="CAL"/> key : Sensitivity adjustment using the internal weight (GX-A / GX-AE / GX-AWP / GX-M series) Sensitivity adjustment with an external weight (GF-A / GF-AWP / GF-M series) *3
EXC	Sensitivity adjustment with an external weight (GX-A / GX-AE / GX-AWP / GX-M series)
U	Same as the <input type="button" value="MODE"/> key
SMP	Same as the <input type="button" value="SAMPLE"/> key
PRT	Same as the <input type="button" value="PRINT"/> key
R	Same as the <input type="button" value="RE-ZERO"/> key (Semi-automatic zero point setting)
RZ	
Z	
T	Tares the balance
TR	
ZR	*1 Zero (Setting the zero point) *2
TST	Perform calibration test with built-in weight. (0.0001g model only)

*1: In GX-A / GF-A / GX-AE software version 1.100 or earlier, the ZR command is not available in USB virtual COM mode connection.

*2: When the load becomes within $\pm 2\%$ of the maximum weight from initial zero point, the zero point is updated, the tare is cleared and zero is displayed. When the load becomes over $\pm 2\%$, the command is not available.

*3: Supported in GX-A / GF-A / GX-AE software version 1.300 or later.

Commands for presetting the tare value

Command string	Function
PT:****.*** g	Sets the tare value. The unit added is the unit that is output in the A&D standard format (3 characters). For the counting or percent mode, gram is used. In the case of setting the preset tare value to 1234.56 g, the input will be <code>PT:1234.56 g</code> . Values exceeding the weighing capacity cannot be set. Negative values cannot be used.
?PT	Requests the tare value. Outputs the tare value set by the PT, T or TR: command.

Command to control piece count

Command string	Function
UW:****.*** g	Sets the unit mass value (weight of 1 piece) The unit added is the unit that is output in the A&D standard format (3 characters). In the case of setting the unit mass value to 1.23 g, the input will be <code>UW:1.23 g</code> . Values exceeding the weighing capacity cannot be set. Negative values cannot be used.
?UW	Requests the mass unit value.

Commands to control the comparator function

Command string	Function
HI:****.*** g	Sets the upper limit value.
HH:****.*** g	Sets the second upper limit value.
LO:****.*** g	Sets the lower limit value.
LL:****.*** g	Sets the second lower limit value. The unit added is the unit that is output in the A&D standard format (3 characters). In the case of setting the upper limit value to 567.89 g, the input will be <code>HI:567.89 g</code> . Values exceeding the weighing capacity cannot be set.
?HI	Requests the upper limit value.
?HH	Requests the second upper limit value.
?LO	Requests the lower limit value.
?LL	Requests the second lower limit value.

- To use a comparator command, set it to the function `[P in 0]` (digital input, upper / lower limits) or `[P in 1]` (Weighing input, upper / lower limits).

Command to control the data memory function (function *dAtA* 1)

UN : mm	Changes the unit mass registration number Enter a number between 01 and 50 for mm.
?UN	Requests the currently selected unit mass registration number.

Command to control the data memory function (function *dAtA* 2)

Command string	Function
?MA	Outputs all data in memory.
?MQnnn	Outputs weighing data with the data number nnn. Input a value from 001 to 200 into nnn.
?MX	Outputs the number of weighing data in memory.
MD : nnn	Deletes weighing data with the data number nnn. Input a value from 001 to 200 into nnn.
MCL	Deletes all data in memory.

Command to control the data memory function (function *dAtA* 3) *4

Command string	Function
CN : mm	Loads the remembered comparator. Input a value from 01 to 20 into mm.
?CN	Requests the currently selected comparator registration number.

Command to control the data memory function (function *dAtA* 4) *4

Command string	Function
PN : mm	Loads the remembered tare value. Input a value from 01 to 20 into mm.
?PN	Requests the currently selected tare registration number.

*4 Command can only be used with GX-M / GF-M.

Commands for setting time and date

Command string	Function
TM : ** : ** : **	Sets time. In the case of setting time to 12 h 34 min 56 sec, the input will be <input type="text" value="TM:12:34:56"/> . Do not set non-existing time values.
DT : ** / ** / **	Sets date. In the case of setting date to Jan 23, 2017, the input will be <input type="text" value="DT:17/01/23"/> . Do not set non-existing date values.
?TM	Requests time setting.
?DT	Requests date setting.

Commands for setting time and date

Command string	Function
?T	Requests the tare weight value. The tare value set by T, TR command is output.
?ID	Requests ID number.
?SN	Requests serial number.
?TN	Requests device name.
?SA	Outputs impact data all at once.

7-2. The <AK> code and error codes

When the function *Errd* (AK, error code on) is set, the balance always responds to reception of all commands sent from a PC or a PLC. Communication reliability is improved by checking the responding code.

When the function *Errd* (AK, error code on) is set, the balance responds with the following.

- When sending a command requesting various data to the balance, if the balance cannot transmit the requested data, it sends an error code (EC, Exx). If the balance can output the requested data, the requested data will be sent.
- When sending a controlling command to the balance, if the balance cannot execute the command, it sends an error code (EC, Exx). If the balance can execute the command, it sends the <AK> code. <AK> code is the ASCII 06h.
- The commands below are processed by the balance, so it will send the <AK> command not only when a command is received, but also at the end of processing. If the process does not end normally, the balance sends an error code (EC, Exx), in which case the error is canceled with the CAL command.

ON command	Display on
P command	Display on / off (However, only when already on)
R, Z, RZ commands	Re-zero (Semi-automatic zero point setting)
T, TR commands	Tare the balance
ZR command	Zero (Setting the zero point) *5
CAL command	Sensitivity adjustment using the internal weight (GX-A / GX-AE / GX-AWP / GX-M series) Sensitivity adjustment with an external weight (GF-A / GF-AWP / GF-M series) *6
EXC command	Sensitivity adjustment with an external weight (GX-A / GX-AE / GX-AWP / GX-M series)

*5: When the load becomes within $\pm 2\%$ of the maximum weight from initial zero point, the zero point is updated, the tare is cleared and zero is displayed. When the load becomes over $\pm 2\%$, the command is not available.

*6: Supported in GF-A software version 1.300 or later.

7-3. Command usage examples

In this example, the function *Errd 1* (AK, error code on) is set in order to output the <AK> code. <AK> code is the ASCII 06h.

Example of the ON command (display on)

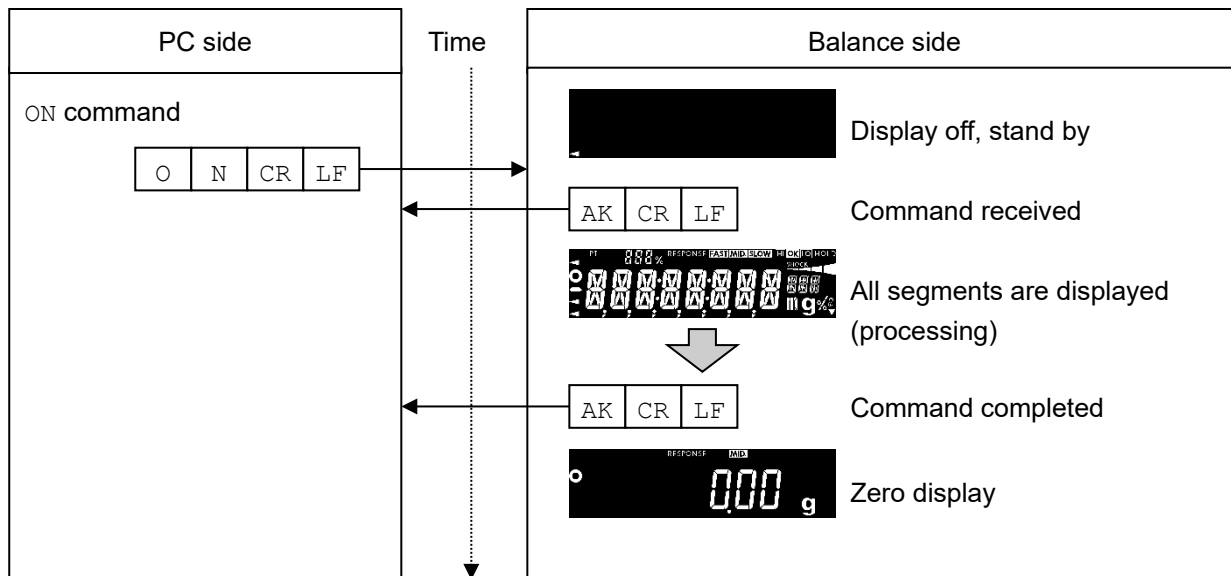

Example of the R command (re-zero)

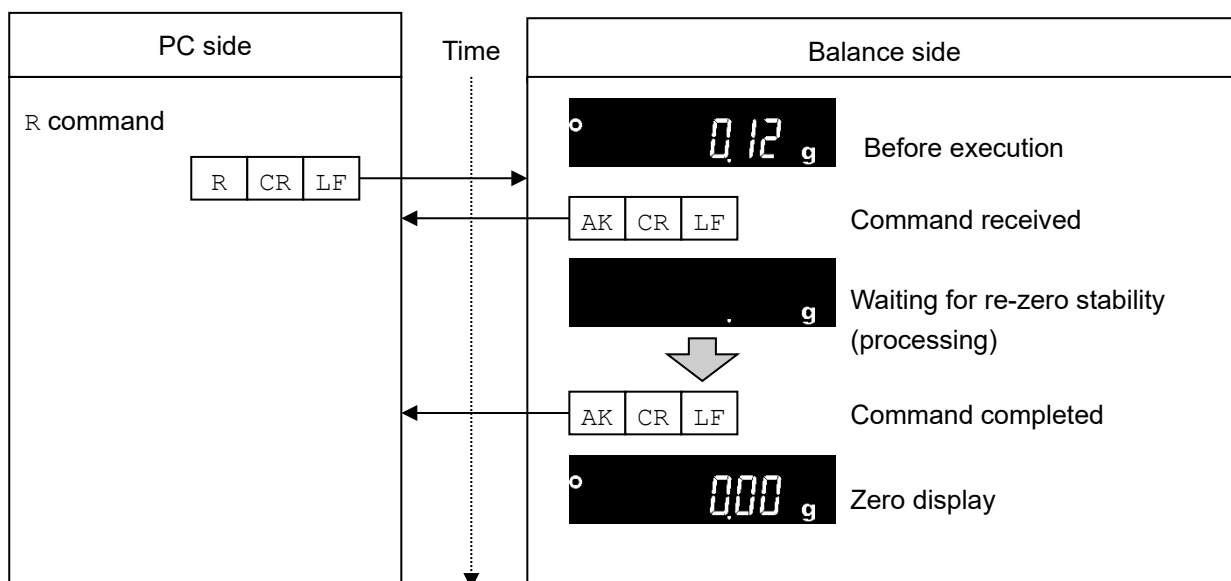

Example of the CAL command Sensitivity adjustment using the internal weight
 (GX-A / GX-AE / GX-AWP / GX-M Series)

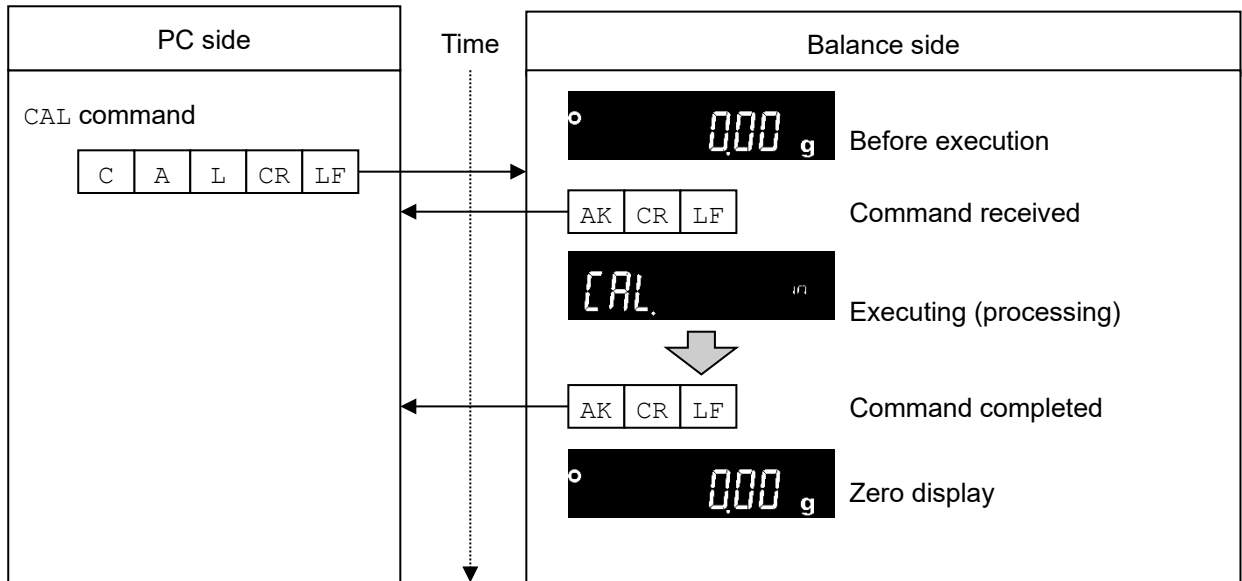

□ For an example of the CAL command of the GF-A series, refer to the EXC command example.

Example of error code output of the R command (re-zero)

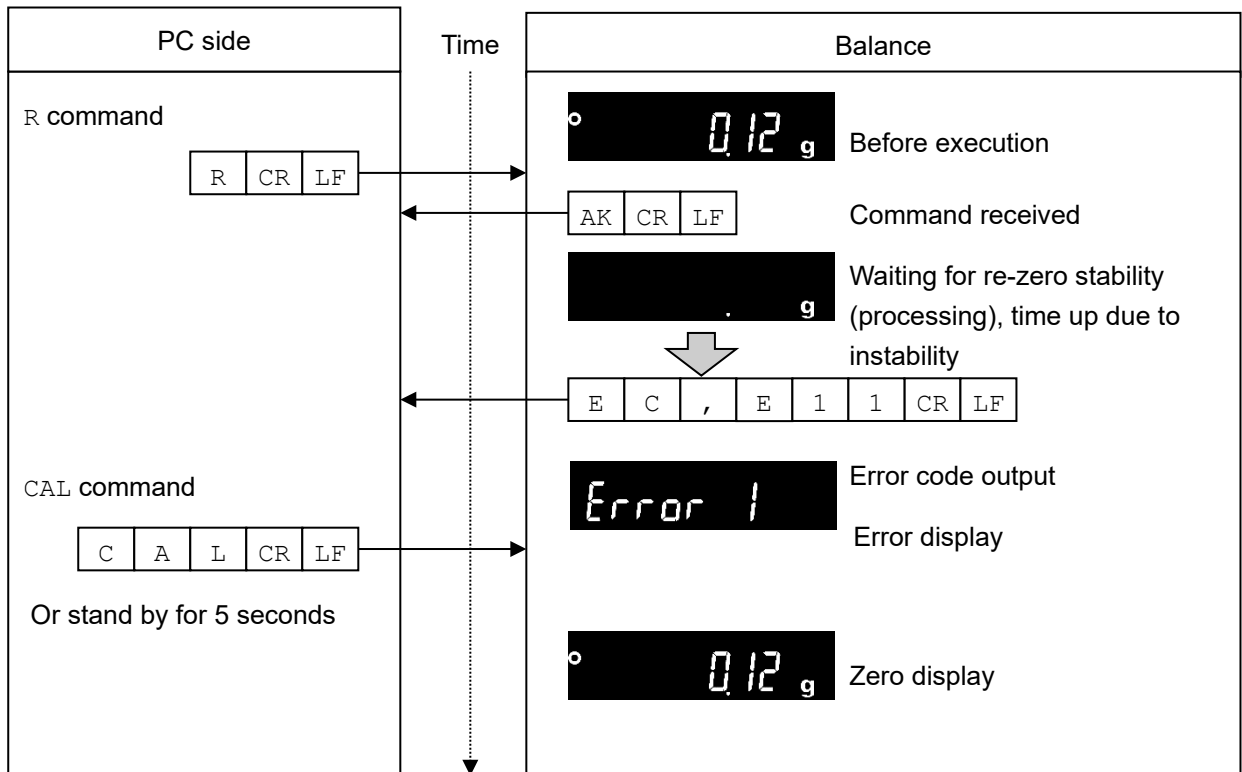

Example of the EXC command Sensitivity adjustment with an external weight (GX-A / GX-AE / GX-AWP / GX-M Series)

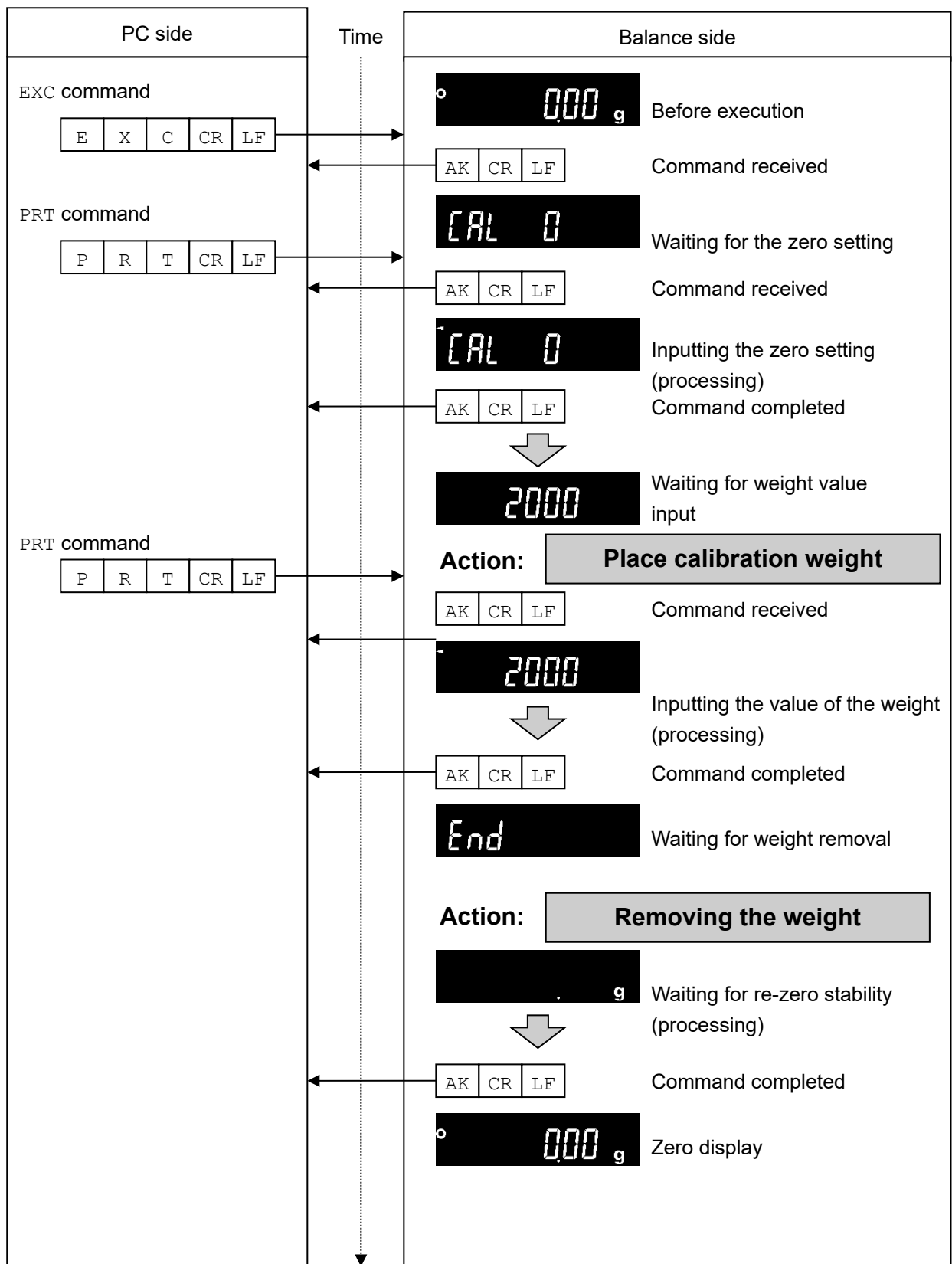

Example of measuring using a container

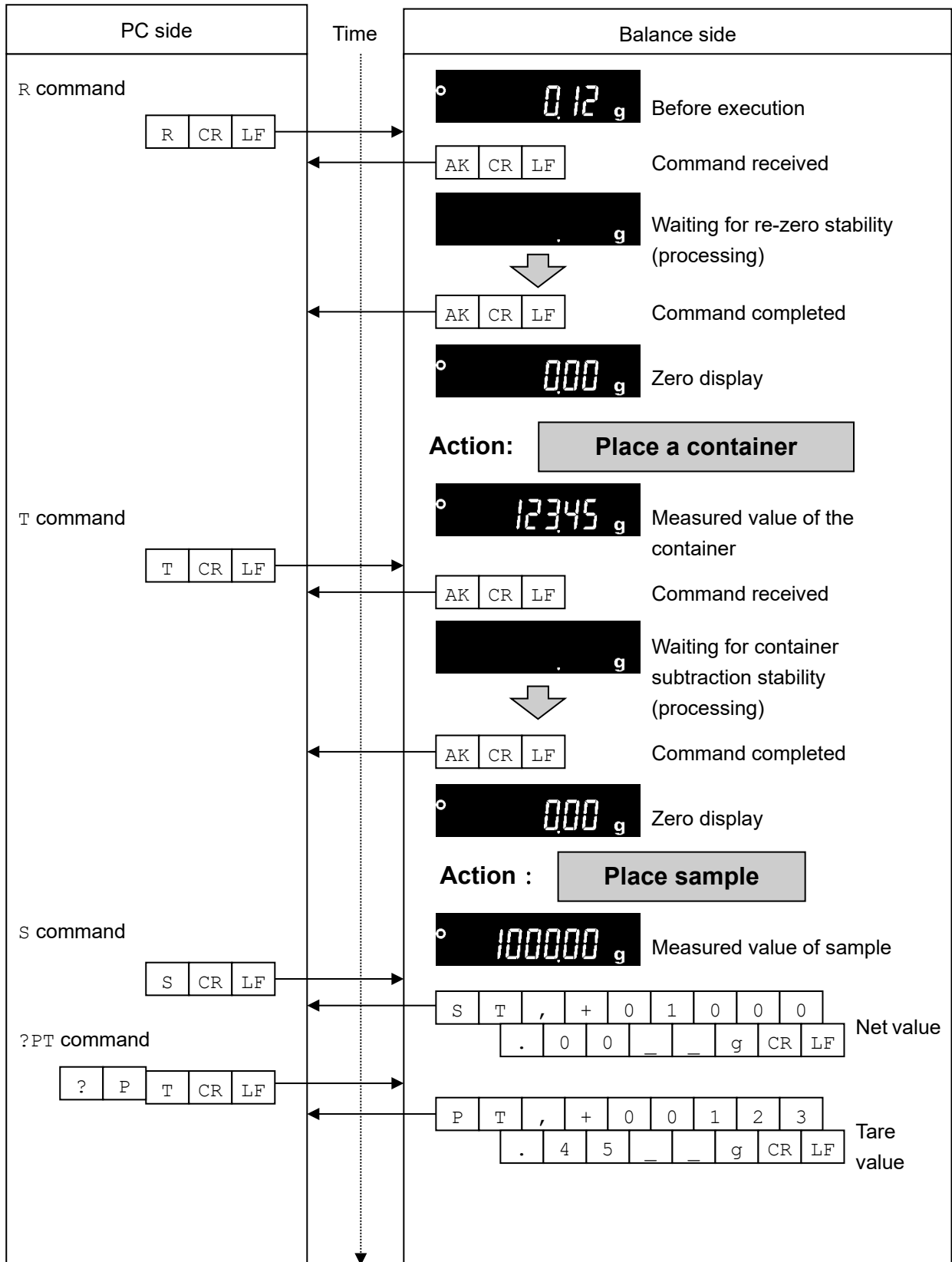

Example of setting a negative target value and filling with a sample until the display becomes zero

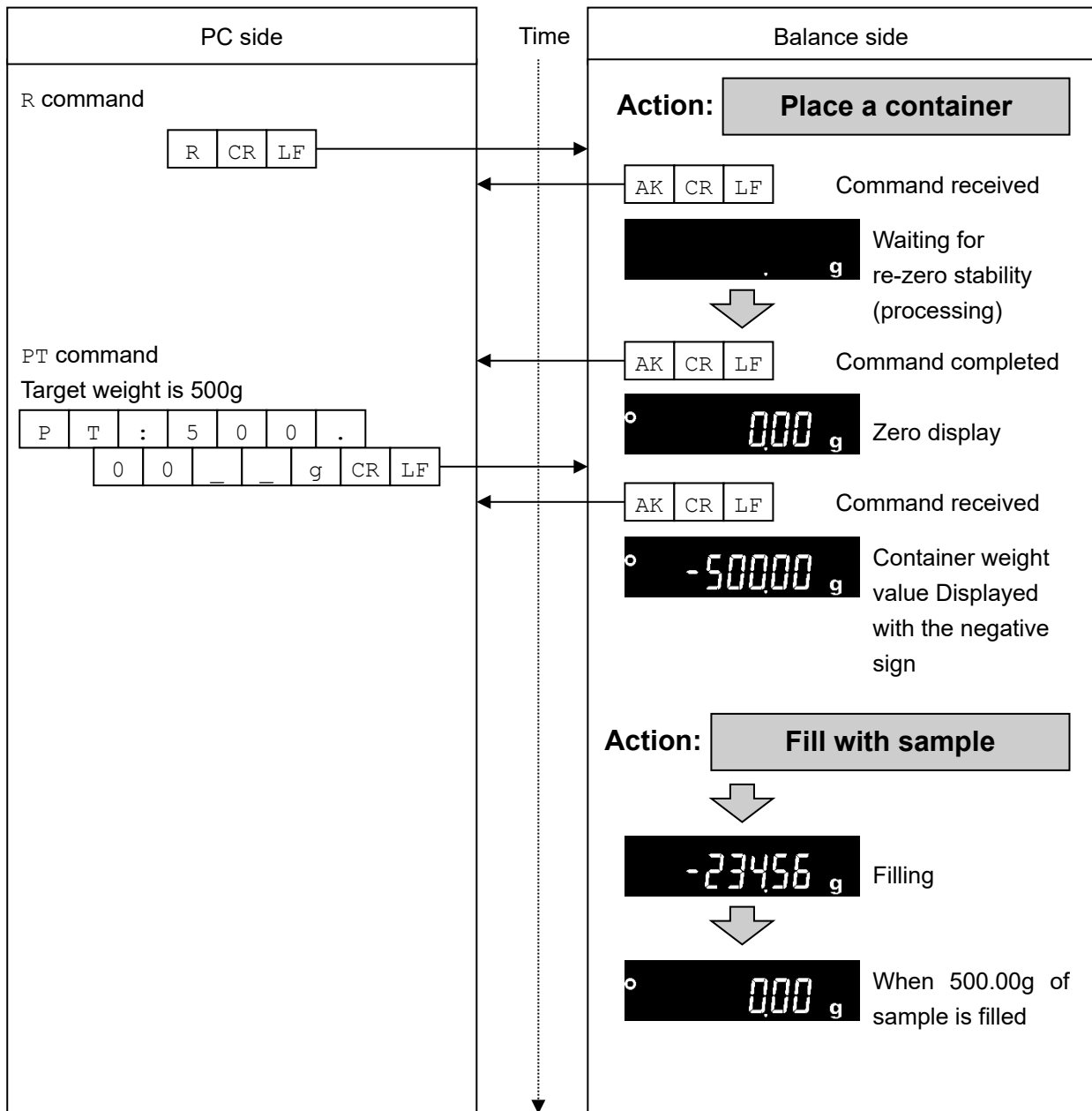

8. Error codes

8-1. Error codes list

Error codes and how to resolve

Error code	Description and how to resolve
EC,E00	Communications error A protocol error occurred in communications. Check the format and the baud rate.
EC,E01	Undefined command error An undefined command was received. Check the command.
EC,E02	Not ready The command received cannot be processed. e.g. The balance received a Q command, which requested the weighing data, but it was not in the weighing mode with the display on. e.g. The balance received a Q command while processing a RE-ZERO command. Adjust the timing of transmitting the command.
EC,E03	Timeout error The balance did not receive the next command more than 1 seconds when the timeout function is set to $t-UP$ i. Check the communication.
EC,E04	Excess characters error The balance received excessive characters in a command. Check the command.
EC,E06	Format error The format of the received command is incorrect. e.g. The data is numerically incorrect. e.g. Alphabet characters are input instead of values. Check the command.
EC,E07	Setting value error The received data exceeds the range of values that the balance can accept. Check the parameter values range of the command.
EC,E11	Weighing values stability error Because the weighing value is unstable, it is not possible to re-zero or sensitivity adjustment. Improve the environment of the location where the balance is installed. Send a CAL command or wait 5 seconds to reset the error.

Error code	Details and ways to address
EC,E16	<p>Built-in weight error</p> <p>There was no change in load even when the built-in weight was raised and lowered. Perform the weighing operation from the beginning without placing anything on the pan.</p>
EC,E17	<p>Built-in weight error</p> <p>There was an error in the mechanism of raising and lowering the built-in weight. Perform the weighing operation from the beginning.</p>
EC,E20	<p>Calibration weight error (heavy)</p> <p>The calibration weight is too heavy. Check the nominal calibration weight value. Send a CAL command or wait 5 seconds to reset the error.</p>
EC,E21	<p>Calibration weight error (light)</p> <p>The calibration weight is too light. Check the nominal calibration weight value. Send a CAL command or wait 5 seconds to reset the error.</p>

9. The UFC Function

By using the UFC (Universal Flex Coms) function, it is possible to arbitrarily output contents of your choice when outputting the weighing data. You can also output a character string when printing a barcode with a label printer or the like.

In order to use the UFC function, it must be set to function `UFC 1` (UFC function on).

9-1. UFC program commands

To select the output format to use, send the program command from the PC and store it in the balance. The stored output format is saved even when the balance is turned off.

How to create program commands

- The maximum number of characters for a program command is 512.
(100 characters in the GX-A / GF-A / GX-AE software version 1.00 to 1.220)
- First, add the `PF,` command.
- Program commands are combined in comma-delimited or space-separated form, but they can be omitted to reduce the number of characters. However, the comma after the `PF` command cannot be omitted.

List of program commands

*In the output example, “_” is a space.

Command	Contents	Example of output
<code>PF,</code>	UFC command header It is appended to the beginning of the program command.	
<code>\$MN</code>	Manufacturer name	_ _ _ _ _ A _ & _ D
<code>\$TY</code>	Model name	_ _ _ G X - 1 0 0 0 2 A
<code>\$SN</code>	Serial number	_ _ _ _ T 1 2 3 4 5 6 7
<code>\$ID</code>	ID number	S A M P L E - 1 2 3 4 - 5
<code>\$DT</code>	Date	2 0 1 8 / 1 2 / 3 1
<code>\$TM</code>	Time of Day	1 2 : 3 4 : 5 6
<code>\$WT</code>	Weight data	_ _ _ + 1 2 3 4 . 5 6 _ _ g
<code>\$GR</code>	Gross data (total amount)	_ _ _ + 1 2 3 4 . 5 6 _ _ g
<code>\$NT</code>	Net data (net)	_ _ _ + 2 3 4 . 5 6 _ _ g
<code>\$TR</code>	Tare data (tare)	_ _ _ + 1 0 0 0 . 0 0 _ _ g
<code>\$PC</code>	Number data	_ _ _ _ _ + 1 2 3 4 _ P C
<code>\$UW</code>	Single data	_ _ _ _ _ + 0 . 1 2 _ _ g
<code>\$CP</code>	Comparator result	H I
<code>\$CM</code>	Comma	,
<code>\$SP</code>	Space	_ (ASCII 20h)
<code>\$CR</code>	<CR>	(ASCII 0Dh)
<code>\$LF</code>	<LF>	(ASCII 0Ah)

- Enclose any ASCII code string in single quotation marks. The character strings that can be output are alphanumeric characters and symbols.

eg: to output the character string "A' BC' D": 'A' ' BC' ' D'

For GX-A / GF-A / GX-AE software version 1.00 to 1.220, the single quotation mark itself is enclosed by two single quotation mark.

eg: to output the character string "A' BC' D": 'A' ' ' BC' ' ' D'

Note

- The commands automatically generated with WinCT-UFC ver.2.00 or later correspond to balance software version 1.300 or later for GX-A / GF-A /GX-AE.
- To output the ASCII control code, enter "# + 2 hexadecimal characters".
For GX-A/GF-A/GX-AE, this is supported in balance software version 1.300.
Example: To output <EOT> (04h) : #04
- Spaces (\$SP), <CR> (\$CR), and <LF> (\$LF) can be repeated with numbers by adding " * + numbers (up to 2 characters)" after the command.
Example: To output 12 spaces : \$SP*12
To output 9 <CR>'s : \$CR*9
- When sending a program command of two or more lines, adding "&" at the end of one line the balance will judge the next line as the continuation of the program command. (only RS-232C)
- The balance sends an error code if there is a problem after receiving a program command and sends an <AK> code if there is no problem. <AK> code is ASCII 06h.
- The UFC setting tool WinCT-UFC is available for inputting program commands.
WinCT-UFC can be downloaded from our website (<https://www.aandd.jp>).

9-2. Examples of creating UFC program commands

Output example 1

```
NET
    +2000.00 g
TARE
    +345.67 g
GROSS
    +2345.67 g
```

Description

PF, command, character string "NET", line break
 Space × 5, net data, line break
 Character string "TARE", line break
 Space × 6, tear data, line break
 Character string "GROSS", line break
 Space × 5, gross data

Example of program command

```
PF, 'NET', $CR, $LF, &
$SP*5, $NT, $CR, $LF, &
'TARE', $CR, $LF, &
$SP*6, $TR, $CR, $LF, &
'GROSS', $CR, $LF, &
$SP*5, $GR, $CR, $LF
```

Terminator

Output example 2

```
2017/01/23 12:34:56
SAMPLE      ABC-123
WEIGHT     +3456.78 g
```

Content

PF, command, date, time, line break
 Character string "SAMPLE ABC-123", line break
 Character string "WEIGHT ", weight data

Example of program command

```
PF, $DT, $TM, $CR, $LF, &
'SAMPLE      ABC-123', $CR, $LF, &
'WEIGHT     ', $WT, $CR, $LF
```

Terminator

Note

- The terminator transmission in UFC format is sent automatically.
 Please add a terminator code at the end of the character data as necessary.
 For GX-A / GF-A / GX-AE software version 1.00 to 1.220, the terminator is set by function `ErLF` is automatically transmitted.





10. Function Table

The function table reads or rewrites the parameters that are stored in the balance. These parameters are maintained in non-volatile memory, even if the AC adapter is removed.

The function table menu consists of two layers. The first layer is the "Class" and the second layer is the "Item".

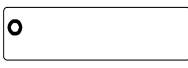
10-1. Setting The Function Table

Display symbol and keys

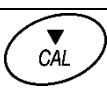
	The symbol "O" shows effective parameter.
	When pressing and holding the key for 2 seconds in the weighing mode, the balance enters the function table mode. The key to select the class or item in the function table mode.
	The key to change the parameter.
	The key to change the parameter.
	When a class is displayed, moves to an item in the class. When an item is displayed, stores the new parameter and displays the next class.
	When an item is displayed, cancels the new parameter and displays the next class. When a class is displayed, exits the function table mode and returns to the weighing mode.

Setting procedure

1. Press and hold the **SAMPLE** key for 2 seconds until **bR5FnC** of the function table is displayed in the weighing mode, then release the key.
2. Press the **SAMPLE** key to select a class.
3. Press the **PRINT** key to enter the class.
4. Press the **RE-ZERO** key to select a parameter for the selected item.
5. Press the **SAMPLE** key to select an item.
6. To change another (multiple) item with the same class, repeat "4" and "5". To end the setting change of the same class, proceed to "7".
7. If storing parameters of the selected class, press the **PRINT** key.
Then the next class is displayed.
If canceling the current operation, press the **CAL** key. Then the next class is displayed.
8. When specifying parameters for another class, proceed to "2".
When finishing the setting, press the **CAL** key to return to weighing mode.

Configuration example

Example of setting "Time/Date output" to "outputting Time/Date" and "Data format" to "DP format".

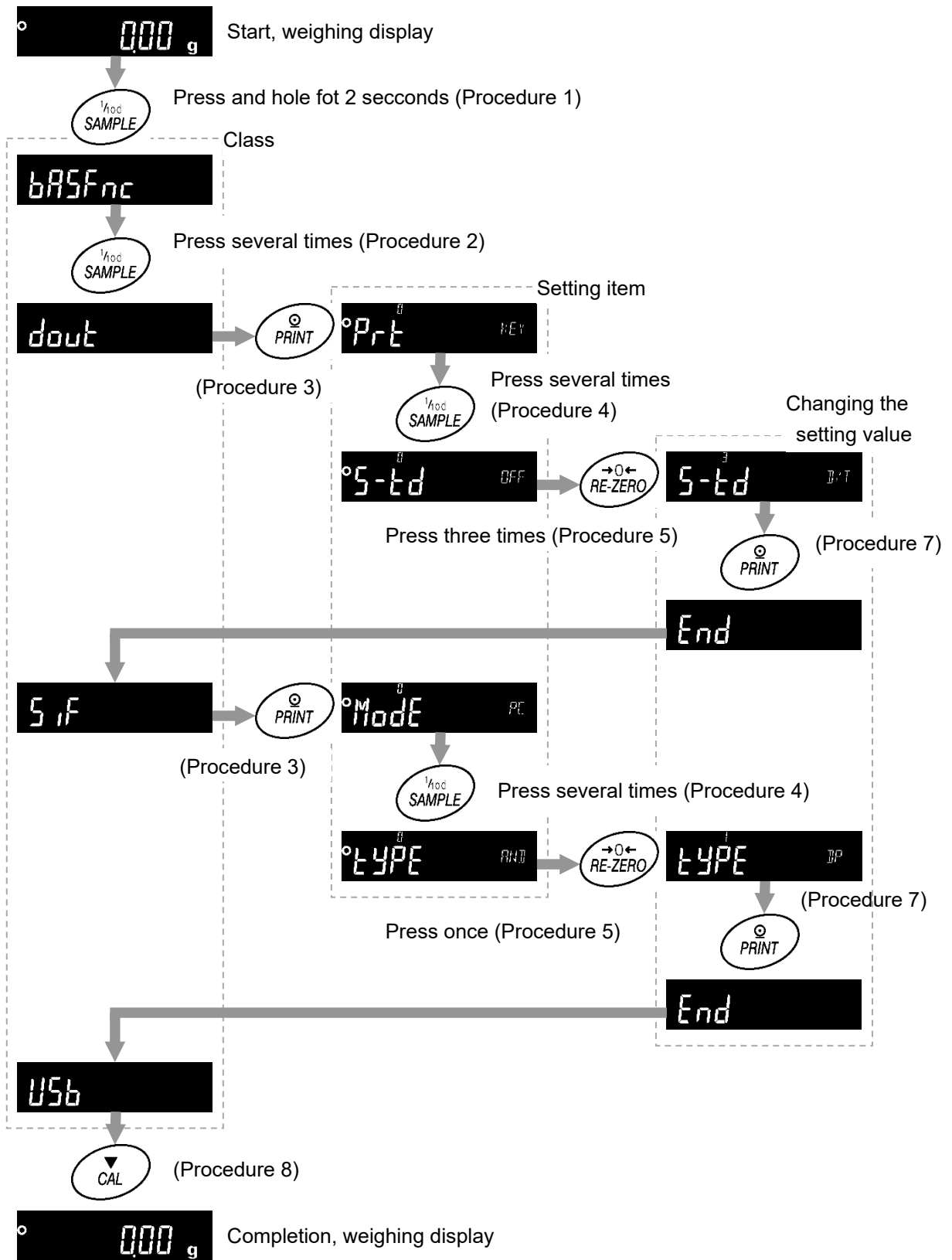

10-2. List of functions (communication class only)

This is a list of functions related to communication.

For other items, refer to the GX-A / GF-A /GX-AE / GX-AWP / GF-AWP / GX-M / GF-M instruction manual.

Class	Item	Parameter	Description	
<i>bASFnC</i> : <i>CP bEEP</i>			Refer to the GX-A / GF-A /GX-AE / GX-AWP / GF-AWP / GX-M / GF-M instruction manual	
<i>dout</i> (Data Out) Data output	<i>Prt</i> (Print) Data output mode	■ 0	Key mode	Output data with the PRINT key when the weighing value is stable.
		1	Auto print mode A (reference = zero point)	Output data when the weighing value is stable and it exceeds the range set by <i>RP-P</i> and <i>RP-b</i> in relation to zero.
		2	Auto print mode B (reference = previous stable value)	Output data when the weighing value is stable and it exceeds the range set by <i>RP-P</i> and <i>RP-b</i> in relation to previous stable value.
		3	Stream mode	Output every time when the display value is renewed.
		4	Key mode B (immediate output)	Data output regardless of stability / instability with the PRINT key.
		5	Key mode C	Data is output when stable with the PRINT key and if unstable, it is output once it has stabilized.
		6	Interval mode	Data output after every cycle set by the <i>int</i> setting.
		<i>RP-P</i> (Auto Print Polarity) Auto print Polarity	■ 0	Plus only
	1		Minus only	Display value < Reference
	2		Bipolarity	Regardless of the value size compared with reference value
	<i>RP-b</i> (Auto Print Band Width) Auto print difference	■ 0	10 d	Difference between reference value and displayed value
		1	100 d	
		2	1000 d	

“■” Factory setting.

“1 d” stands for a smallest displayed order. In case of GX-303A 1 d is 0.001g.

Class	Item	Parameter	Description	
<i>dout</i> (Data Out) Data output (Cont.)	<i>dAtA</i> (Data Memory) Data memory function	■ 0	No used	
		1	Stores unit mass	
		2	Stores weighing data and sensitivity adjustment data	
		3 *	Stores comparator setting value	
		4 *	Stores tare value	
	<i>int</i> (Interval Time) Interval time	0	Every measurement	Set interval time of interval mode <i>Pr t</i> 6
		■ 1	Every 2 seconds	
		2	Every 5 seconds	
		3	Every 10 seconds	
		4	Every 30 seconds	
		5	Every 1 minute	
		6	Every 2 minutes	
		7	Every 5 minutes	
	<i>d-no</i> (Data No.) Data number output	■ 0	Do not output	Refer to "6-4. Other data formats"
		1	Output	
	<i>S-t d</i> (Send Time Date) Time/Date output	■ 0	Do not output	Refer to "6-4. Other data formats"
		1	Time only	
		2	Date only	
		3	Output date and time	
	<i>S- id</i> (Send ID) ID number output	■ 0	Do not output	Refer to "6-4. Other data formats"
1		Output		
<i>PUSE</i> (Pause) Data output pause	■ 0	Off	Select interval before data output	
	1	1.6-second pause		
<i>At-F</i> (Auto Feed) Auto feed	■ 0	Off	Select line feed (paper feed) after data output	
	1	Leave one line open		
<i>info</i> (Information) GLP output	■ 0	Do not output		
	1	On (output built-in clock)		
	2	On (output external clock)		
<i>Ar-d</i> (Auto Re-zero After Data Output) Auto re-zero	■ 0	Off	Select re-zero after data output	
	1	On		
<i>UFC</i> (Universal Flex Coms) UFC function	■ 0	Off	Refer to "9. The UFC Function"	
	1	On		

□ "■" Factory setting.

* GX-M / GF-M series only

Class	Item	Parameter	Description	
SIF (Serial Interface) Serial interface	MODE (Mode) Access Point	■ 0	PC	TYPE 0 or 1 TYPE 0 and stream output
		1	Printer	
		2	External display	
	BPS (Bits Per Second) Baud rate	0	600 bps	
		1	1200 bps	
		■ 2	2400 bps	
		3	4800 bps	
		4	9600 bps	
		5	19200 bps	
		6	38400 bps	
	bPr (Bits Parity) Data bit, parity bit	■ 0	7 bit EVEN	
		1	7 bit ODD	
		2	8 bit NONE	
	CrLF (Carriage Return, Line Feed) Terminator	■ 0	CR LF	CR: ASCII 0Dh LF: ASCII 0Ah
		1	CR	
	TYPE (Type) Data format	■ 0	A&D Standard format	Refer to "6-2. Weighing data format "
		1	DP format	
		2	KF format	
		3	MT format	
		4	NU format	
5		CSV format		
6		NU2 format		
t-UP (Time Up) Command time out	0	No limit	Select waiting time during command reception	
	■ 1	Limited to 1 second		
ErCd (Error Code) AK, error code	0	Off	Refer to "7-2. The <AK> code and error codes"	
	■ 1	On		
USB (Universal Serial Bus) USB Interface	UFnc (USB Function) USB Function mode	0	Quick USB	Setting values differ depending on the software version of the valance. Refer to "5-1. Quick USB mode" Refer to "5-2. Virtual COM mode"
		■ 1	Bi-directional USB virtual COM	
	U-tP (USB Type) USB Data format	■ 0	A&D standard format	Refer to "6-2. Weighing data format"
		1	NU format	
		2	CSV format	
	3	TAB format		
	4	NU2 format		
AP Fnc ⋮ CS in			Refer to the GX-A / GF-A / GX-AE / GX-AWP / GF-AWP / GX-M / GF-M instruction manual	

□ "■" Factory setting.

11. Key Lock Function

Key switches of the balance can be locked by sending a specified command to the balance.

This is effective for controlling the balance only from an external device such as a PC.

- Even if key switches are locked, operations related to key control commands are available.
(For key control commands, refer to section "7. Commands".)
- Key lock status can be checked by sending a command for confirmation to the balance.
- Key lock is maintained until either the balance receives key unlock command or the power is turned off by unplugging the AC adapter.

11-1. Locking all key switches

All the key switches can be disabled by sending the `KL` command to the balance as follows.

Command string	Function
?KL	Requests all key lock statuses. KL,000 Cancels all key locks. KL,001 Checks status for all key locks
KL:***	KL:000 Cancels all key locks. KL:001 Sets all key locks. 000 or 001 should be input for ***.

11-2. Locking specified key switches

By assigning a numerical value for * * * * * of a LK command, specific key switches can be disabled.

The numerical value for * * * * * is the total of the decimal numbers converted from the bit value assigned for each key switch as shown below.

GX-M / GF-M and GX-AE / GX-A / GF-A software version 1.211 or later supports LK commands.

Bit	Decimal number	Key switch
0	1	ON:OFF
1	2	CAL
2	4	MODE
3	8	SAMPLE
4	16	PRINT
5	32	RE-ZERO

Example1: When locking all the switches except for PRINT.

- Add all the decimal numbers corresponding to keys to lock.
 $1 (\text{ON:OFF}) + 2 (\text{CAL}) + 4 (\text{MODE}) + 8 (\text{SAMPLE}) + 32 (\text{RE-ZERO}) = 47$
- Send the numeral value sum with a LK command to the balance. LK:00047

Example2: Unlock all keys switches.

- Since there is no key switch to lock, 0 is sent to the balance with LK: command. LK:00000

Command string	Function
?LK	Requests status for a specified key lock. Example 1 : When all the key switches except for PRINT are locked. LK,00047 Example 2 : When none of the switches are locked. LK,00000
LK:* * * * *	Locks specified key switches.s Numerical value from 00000 to 00063 should be in * * * * *. Example 1: When locking all the key switches except for PRINT. LK:00047

12. Checking the Software Version of the Balance

Specifications of the balance may differ depending on the software version that you use.
To confirm the software version, follow the steps shown below.

1. Unplug the AC adapter of the balance and then plug it in again.

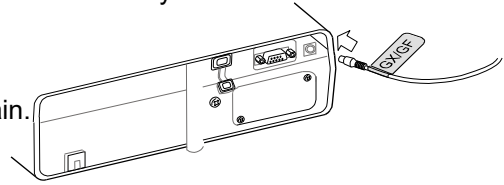

2. The **LEVEL** display will blink.*
* GX-M/GF-M series does not have **LEVEL** display.



3. Then, **P- * . * * *** is displayed.
The number for * . * * * is the software version.

THIS PAGE INTENTIONALLY LEFT BLANK.



A&D Company, Limited

3-23-14 Higashi-Ikebukuro, Toshima-ku, Tokyo 170-0013, JAPAN
Telephone: [81] (3) 5391-6132 Fax: [81] (3) 5391-1566

A&D ENGINEERING, INC.

47747 Warm Springs Blvd, Fremont, California 94539, U.S.A.
Tel: [1] (800) 726-3364 Weighing Support:[1] (888) 726-5931 Inspection Support:[1] (855) 332-8815

A&D INSTRUMENTS LIMITED

Unit 24/26 Blacklands Way, Abingdon Business Park, Abingdon, Oxfordshire OX14 1DY United Kingdom
Telephone: [44] (1235) 550420 Fax: [44] (1235) 550485

A&D AUSTRALASIA PTY LTD

32 Dew Street, Thebarton, South Australia 5031, AUSTRALIA
Telephone: [61] (8) 8301-8100 Fax: [61] (8) 8352-7409

A&D KOREA Limited

한국에이.엔.디(주)
서울특별시 영등포구 국제금융로6길33 (여의도동) 맨하탄빌딩 817 우편 번호 07331
(817, Manhattan Bldg., 33. Gukjegeumyung-ro 6-gil, Yeongdeungpo-gu, Seoul, 07331 Korea)
전화: [82] (2) 780-4101 팩스: [82] (2) 782-4264

ООО A&D RUS

ООО "ЭЙ энд ДИ РУС"

Почтовый адрес:121357, Российская Федерация, г.Москва, ул. Верейская, дом 17
Юридический адрес: 117545, Российская Федерация, г. Москва, ул. Дорожная, д.3, корп.6, комн. 86
(121357, Russian Federation, Moscow, Vereyskaya Street 17)
тел.: [7] (495) 937-33-44 факс: [7] (495) 937-55-66

A&D Instruments India Private Limited

ऐ&डी इन्स्ट्रुमेंट्स इण्डिया प्रा० लिमिटेड

D-48, उद्योग विहार , फेस -5, गुडगांव - 122016, हरियाणा , भारत
(D-48, Udyog Vihar, Phase-V, Gurgaon - 122016, Haryana, India)
फोन : [91] (124) 4715555 फैक्स : [91] (124) 4715599

A&D SCIENTECH TAIWAN LIMITED. A&D台灣分公司 艾安得股份有限公司

台湾台北市中正區青島東路5號4樓
(4F No.5 Ching Tao East Road, Taipei Taiwan R.O.C.)
Tel : [886](02) 2322-4722 Fax : [886](02) 2392-1794

A&D INSTRUMENTS (THAILAND) LIMITED

บริษัท เอ แอนด์ ดี อินสตรูमेंท์ (ไทยแลนด์) จำกัด

168/16 หมู่ที่ 1 ตำบลรังสิต อำเภอธัญบุรี จังหวัดปทุมธานี 12110 ประเทศไทย
(168/16 Moo 1, Rangsit, Thanyaburi, Pathumthani 12110 Thailand)
Tel : [66] 20038911