

# FS-D

## SET UP INSTRUCTIONS

---



---

### **Weighing Indicator** **for Check Weighing Scales**



## This Manual and Marks

All safety messages are identified by the following, "WARNING" or "CAUTION", of ANSI Z535.4 (American National Standard Institute: Product Safety Signs and Labels). The meanings are as follows:

 WARNING	A potentially hazardous situation which, if not avoided, could result in death or serious injury.
 CAUTION	A potentially hazardous situation which, if not avoided, may result in minor or moderate injury.



This is a hazard alert mark.

Note This manual is subject to change without notice at any time to improve the product. No part of this manual may be photocopied, reproduced, or translated into another language without the prior written consent of the A&D Company.

Product specifications are subject to change without any obligation on the part of the manufacture.

Copyright©2011 A&D Company, Limited

# Contents

<b>1. COMPLIANCE</b> .....	<b>4</b>
<b>2. INTRODUCTION</b> .....	<b>5</b>
<b>3. UNPACKING</b> .....	<b>6</b>
<b>4. INSTALLATION and PRECAUTIONS</b> .....	<b>7</b>
4-1. Precautions for Installing the Indicator .....	7
4-2. Load Cell Connections .....	7
4-3. Verifying Load Cell Output and Input Sensitivity.....	8
4-4. Setting Up the Indicator.....	9
4-5. Parameter Settings and Calibration.....	9
<b>5. NAMES AND FUNCTIONS</b> .....	<b>10</b>
<b>6. FUNCTION PARAMETER SETTINGS</b> .....	<b>12</b>
6-1. The procedure for setting parameters .....	12
6-2. Function list .....	13
<b>7. CALIBRATION</b> .....	<b>14</b>
7-1. Calibration using a weight .....	14
7-2. Gravity acceleration correction.....	15
<b>8. AUTO-TARE FUNCTION</b> .....	<b>16</b>
<b>9. ADDITIONAL INFORMATION</b> .....	<b>17</b>
9-1. F-Function list.....	17
9-2. OP-03 RS-232C .....	17
9-3. OP-04 RS-422 / 485.....	19
<b>10. ERROR MESSAGES</b> .....	<b>20</b>
<b>11. SPECIFICATIONS</b> .....	<b>21</b>
11-1. Capacity and minimum display .....	21
11-2. Specifications .....	21
11-3. Options .....	22
11-4. Dimensions.....	22

---

# 1. COMPLIANCE

---

## Compliance with FCC rules

- ❑ Please note that this equipment generates, uses and can radiate radio frequency energy. This equipment has been tested and has been found to comply with the limits of Class A digital devices pursuant to Part 15 of FCC rules. These rules are designed to provide reasonable protection against interference when equipment is operated in a commercial environment. If this unit is operated in a residential area, it may cause some interference and under these circumstances the user would be required to take, at his own expense, whatever measures are necessary to eliminate the interference. (FCC = Federal Communications Commission in the U.S.A.)

## Classification of protection provided by enclosures

- ❑ The equipment is designed to comply with the IP Code of IEC 60529.  
The “IP65” is explained as follows:
  - “IP” International Protection.
  - “6” Against ingress of solid foreign objects.  
Dust-tight. No ingress of dust.
  - “5” Against ingress of water with harmful effects.  
Protected against water jets (no powerful jets). Water projected in jets against the enclosure from any direction shall have no harmful effects.

---

## 2. INTRODUCTION

---

This manual describes how this product works and how to get the most out of it in terms of performance.

The FS-D weighing indicator is used to build high performance check weighing scales. It has similar specifications and functions as an indicator of the FS-*i* series.

**Please refer to the instruction manual for the FS-*i* supplied with the FS-D.**

The FS-D indicator has the following features.

- The indicator can be used to build platform scales from 6 kg (15 lb) capacity to 1500 kg (3500 lb) capacity.
- The indicator can drive up to 4 x 350  $\Omega$  load cells.
- Three weight display resolutions are available, 1/3,000, 1/6,000 (~1/7,500) and 1/12,000 (~1/15,000) to cover various applications.
- Weighing units are **kg** (kilogram), **g** (gram), **lb** (pound), **oz** (ounce), and **lb-oz** (pound and ounce). However, the FS-D set to a capacity higher than 30 kg (70 lb) does not have all of them. Refer to “[11-1. Capacity and minimum display](#)” in detail.
- Waterproof to IP-65 specifications.
- Constructed from stainless steel for harsh working environments.
- Large liquid crystal display with back lighting and analog sweep display of 60 segments with back lighting.
- AC power source (100V ~ 240V), and an optional SLA (sealed lead acid) battery is available for operation where AC power is not available.
- Built in comparator lights with large and bright red, green and yellow LEDs for better visibility.
- Two modes of comparator operation, Target weight setting and Upper / Lower limits setting.
- Take-away check weighing with auto-tare function.
- Optional serial data and comparator relay interface.

# 3. UNPACKING

Unpack the indicator carefully and keep the packing material if you are likely to transport the indicator again in the future.

When unpacking, check whether all of the following items are included:

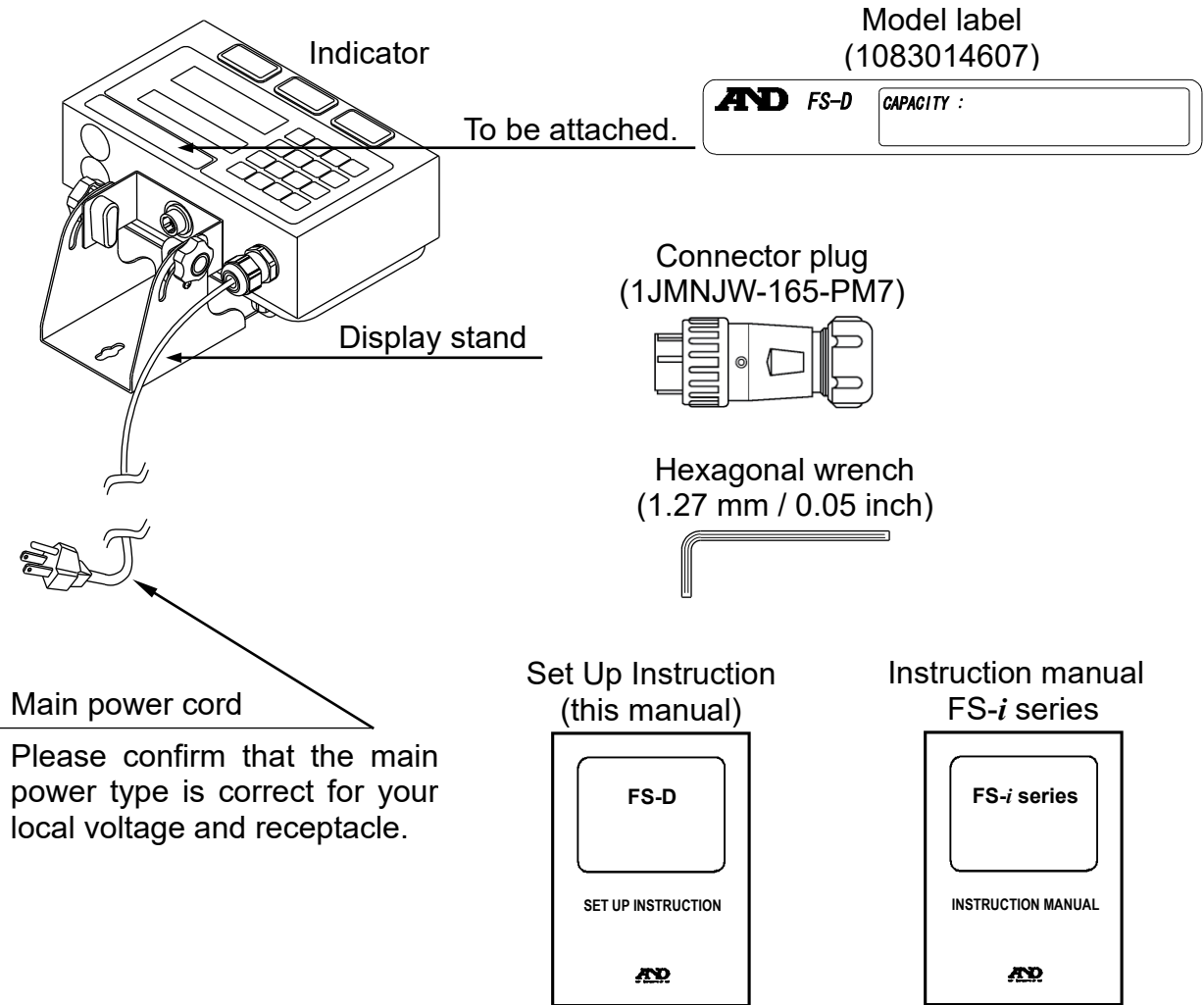





---

## 4. INSTALLATION and PRECAUTIONS

---

### 4-1. Precautions for Installing the Indicator

-   Ground the indicator so that the user will not be subjected an electric shock.
-   Do not handle the main power cord with wet hands.
-   The AC plug is not water-resistant. Install it in an area where it does not get wet.
-   Do not install the indicator where there is flammable or corrosive gas present.
- Do not install the indicator under water.
- Do not pull, fold or arrange cables forcibly.
- Use shielded cables for all connections.
- Ground the platform to be connected to the indicator to avoid a risk of electric shock.

Read the section “CAUTION” in the instruction manual of the FS-*i* to understand the conditions and precautions for installation, operation and cleaning the indicator.

### 4-2. Load Cell Connections

- Solder the load cell cable to the connector plug (1JMNJW-165-PM7) provided with the FS-D and connect it to the connector on the bottom of the FS-D.
1. Use the supplied hexagonal wrench (1.27 mm / 0.05 inch) to loosen the setscrews A and B to disassemble the connector plug.

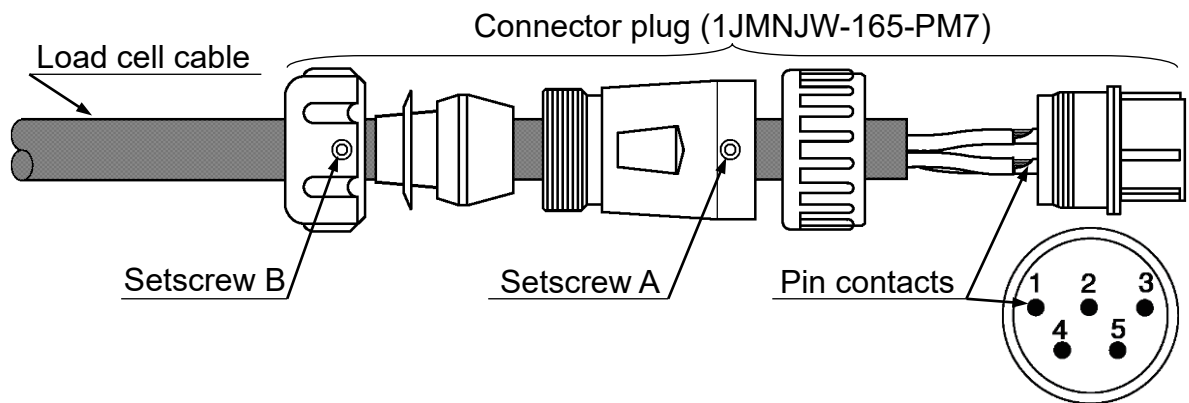

2. Put the load cell cable through each parts of the connector taking care of their order and directions.
  3. Remove the sheath and wire covering of the load cell cable referring to the drawing below.
- The external diameter of the applicable load cell cable is  $\text{Ø}5.7 \sim \text{Ø}6.8$  mm.

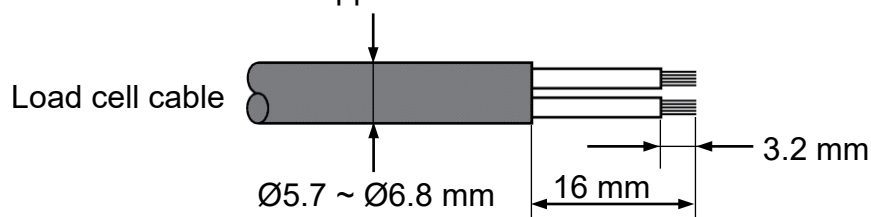

4. Solder the wires to the pin contacts of the connector.
  - ❑ A 5 m or less load cell cable is recommended as the FS-D uses a 4 wire system (no remote sensing).

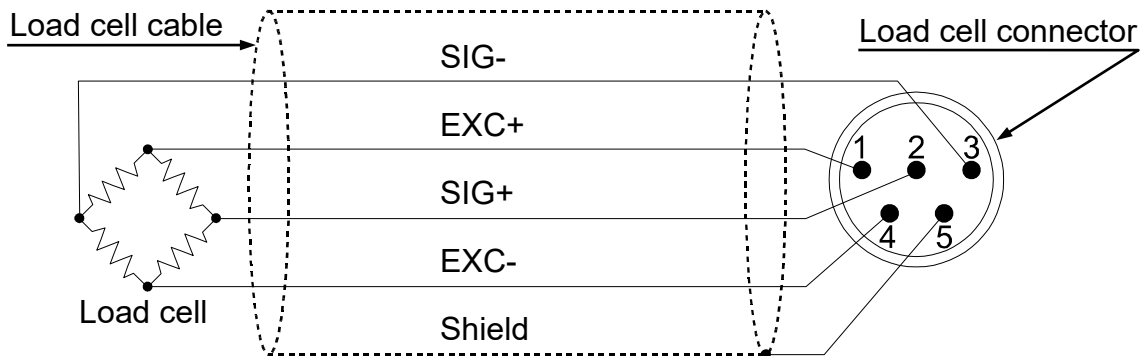

5. Reassemble the connector plug and tighten the setscrew A.
6. Move the load cell cable back and forth and around, and tighten each parts again. Finally, tighten the setscrew B.
7. Connect the connector plug to the load cell connector on the bottom of the display pod.

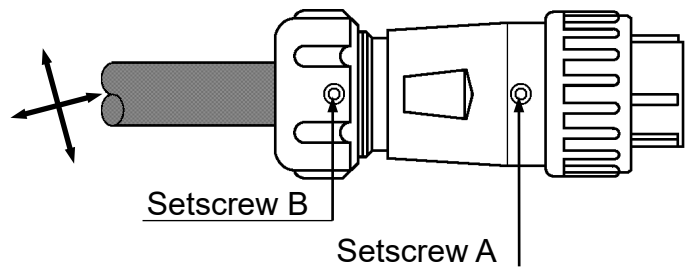

### 4-3. Verifying Load Cell Output and Input Sensitivity

The input sensitivity is 0.2  $\mu\text{V}/\text{division}$  or more. When designing a weighing scale, the load cell output voltage should satisfy the input sensitivity of the indicator. Or the scale should be designed so that the following calculating formula is satisfied.

- ❑ In order to achieve a scale with stable performance, select the input sensitivity as large as possible.

Calculating formula:

$$0.2 \leq \frac{E \times B \times d}{A \times n}$$

**A** : Rated capacity of load cell (kg)

**B** : Rated output (mV/V)

**d** : Min. display (smallest of kg) / scale division

**E** : Excitation voltage (mV) = 5000 mV for FS-D

**n** : Number of load cells

Example of calculation:

In the case of designing a scale with a capacity of 60 kg, using a load cell with a rated capacity of 100 kg and rated output of 1 mV/V:

Load cell capacity: **A** = 100 kg

Rated output: **B** = 1 mV/V

Set function setting [02-3], then

Min. display (smallest): **d** = 0.005 kg

Excitation voltage: **E** = 5000 mV

Number of load cell: **n** = 1

$$\frac{5000 \times 1 \times 0.005}{100 \times 1} = 0.25 > 0.2$$



## 4-4. Setting Up the Indicator

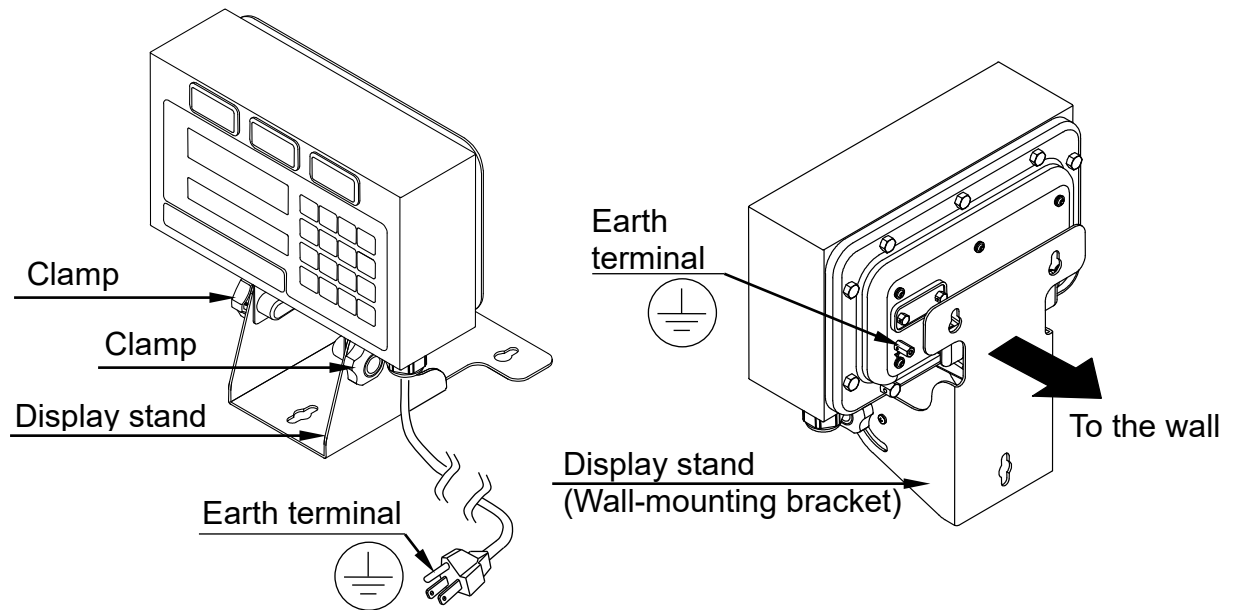

-   Connect the main power cord to an outlet that has an earth ground terminal. You may use the earth terminal on the rear side of the display to ground the indicator.
- If necessary, adjust the viewing angle of the display by loosening the 2 clamps, changing the angle and re-tightening the clamps.
- The Display stand can be secured on a table or flat surface using screws (not supplied). It can be also used as a wall-mounting bracket. See “[11-4. Dimensions](#)” about the dimensions of the mounting holes.

## 4-5. Parameter Settings and Calibration

When a platform scale is initially set up, it is necessary to set some parameters and calibrate it using a calibration weight.

See “[6. FUNCTION PARAMETER SETTINGS](#)” to set parameters and “[7. CALIBRATION](#)” to calibrate the scale.

# 5. NAMES AND FUNCTIONS

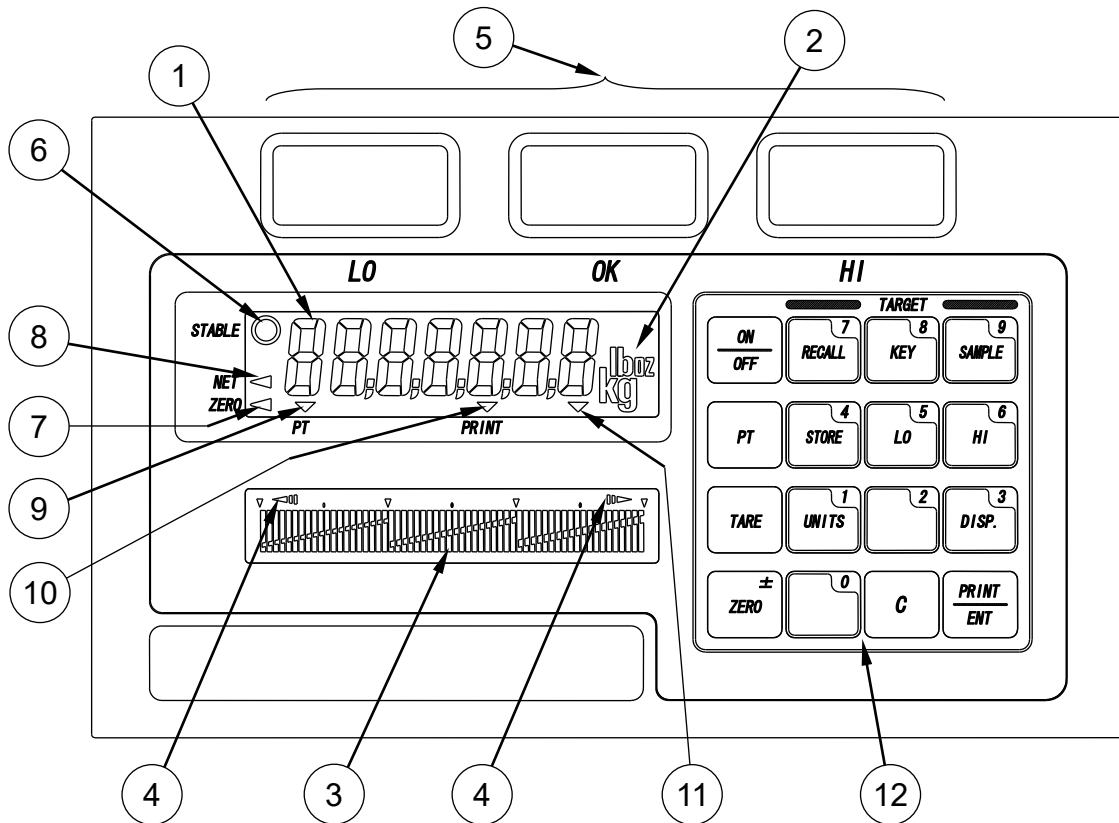
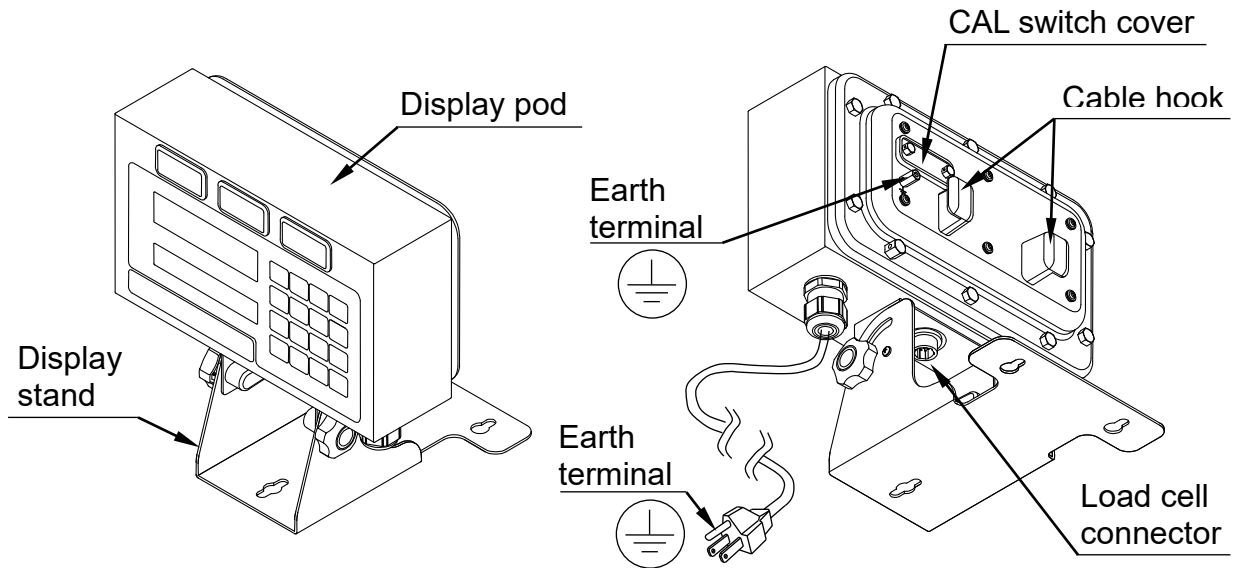

No.	NAMES	FUNCTIONS / OPERATION
1	WEIGHT DATA DISPLAY	Indicates the weight data.
2	WEIGHING UNIT INDICATOR	Indicates the weighing unit in use.
3	ANALOG WEIGHT DISPLAY	Indicates zero to full scale or comparison limits and results.
4	OVER RANGE INDICATORS	Turns ON when the weight is outside the range of the analog sweep display.

No.	NAMES	FUNCTIONS / OPERATION
⑤	COMPARISON INDICATORS	Indicates the results of the weight comparison LO (RED), OK (GREEN) and HI (YELLOW).
⑥	STABLE ANNUNCIATOR	Turns ON when the weight reading is STABLE.
⑦	ZERO ANNUNCIATOR	Turns ON when the weight is in the center of ZERO range.
⑧	NET ANNUNCIATOR	Turns ON when the display shows the NET weight.
⑨	PT ANNUNCIATOR	Turns ON when the display shows the preset tare weight.
⑩	PRINT ANNUNCIATOR	Turns ON for a moment when the weight data is sent by the <span style="border: 1px solid black; padding: 2px;">PRINT/ENT</span> or auto-printing.
⑪	PRECAUTION AGAINST LOW BATTERY	Turns ON when the optional battery is getting close to low battery.
⑫	ON/OFF Key	Turns the power on or off. When turned on, the power-on zero will work.
	ZERO / ± Key	Zeroes the indicator when the weight is stable. Or the key switches the sign “+” & “-”.
	TARE Key	Zeroes the display and switches to net weight mode when the weight is plus and stable.
	PT Key	The key is used to enter a tare weight via the 10-key pad.
	SAMPLE / 9 Key	To register the sample weight as a target. Or the numeric key 9 in the data entry.
	KEY / 8 Key	To enter a target weight via the 10-key pad. Or the numeric 8 in the data entry.
	RECALL / 7 Key	To recall target weight and/or HI/LO limits. Or the numeric 7 in the data entry.
	HI / 6 Key	To enter comparator HI limit via the 10-key pad. Or the numeric 6 in the data entry.
	LO / 5 Key	To enter comparator LO limit via the 10-key pad. Or the numeric 5 in the data entry.
	STORE / 4 Key	To store target weight and/or HI/LO limits. Or the numeric 4 in the data entry.
	DISP. / 3 Key	Switches the analog sweep display modes. Or the numeric 3 in the data entry.
	UNITS / 1 Key	To select the desired weighing unit. Or the numeric 1 in the data entry.
	PRINT / ENT Key	To send a data string through the optional interface. Or to ENTER the numeric data.
C Key	The key to clear an incorrect data entry from the numeric keypad.	
0 and 2 Keys	The numeric keys 0 and 2.	

## 6. FUNCTION PARAMETER SETTINGS

To design a platform scale, set the capacity, weighing unit and other functions according to the specifications of the scale.

Normally, end users do not have to set these function parameters and these setting can be sealed together with the calibration switch.

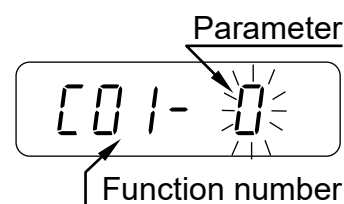

### 6-1. The procedure for setting parameters

- ⚠  Do not set “ $[001-1]$ ”. Once set, the indicator cannot get into the parameter setting procedure again.
  - When turning the power on and the indicator may display  $[-----]$ , press the  $[PRINT/ENT]$  key to proceed to the weighing mode.
  - See “7. CALIBRATION” as for the location of the calibration (CAL) switch.
1. In the weighing mode, press and hold the calibration (CAL) switch until  $[CAL]$  appears. Then, release the switch.
 

$[CAL]$
  - Press and hold the  $[0]$  key for about 5 seconds, then you can also enter the calibration mode (when “ $[001-0]$ ” is set).
  - Press the  $[ON/OFF]$  key or (CAL) switch to stop the setting procedure.
2. Press and hold the  $[ZERO]$  key and press the  $[PRINT/ENT]$  key. Then the first function number is displayed.
 

$[001-]$
  3. Press the  $[2]$  key to enter into the “ $[002]$  Capacity” setting.
 

$[002-]$
  4. Press the  $[PRINT/ENT]$  key. Then the parameter stored appears.
 

$[002-0]$
  5. Enter the parameter value for the capacity using the 10-key pad.
 

$[002-2]$
  6. Press the  $[ZERO]$  key to go to the next function number “ $[003]$  Weighing display unit”.
 

$[003-1]$
  7. Set  $[003]$  “0” (metric unit), or “1” (non-metric unit).
  8. The settings  $[002]$  and  $[003]$  are minimum requirements to design a platform scale. To finalize the settings, be sure to press the  $[PRINT/ENTER]$  key. Then, the display shows  $[End]$  for a few seconds and returns to weighing mode.
 

$[End]$
- The  $[ZERO]$  key increments the function number as in the step 6 above, but note that all of the new parameters are not stored until  $[End]$  is displayed.
  - To exit with nothing changed, turn the power off without pressing the  $[PRINT/ENT]$  key.
  - Set the other parameters according to the specifications required.

## 6-2. Function list

Item	Function number	Description	
Calibration	◆ [01- 0]	CAL switch enabled, [0] key enabled	⚠ Do not set "[01- 1]"
	[01- 1]	CAL switch disabled, [0] key disabled	
	[01- 2]	CAL switch enabled, [0] key disabled	
Capacity	◆ [02- 0]	6 kg (15 lb)	
	[02- 1]	15 kg (35 lb)	
	[02- 2]	30 kg (70 lb)	
	[02- 3]	60 kg (150 lb)	
	[02- 4]	150 kg (350 lb)	
	[02- 5]	300 kg (700 lb)	
	[02- 6]	600 kg (1500 lb)	
	[02- 7]	1500 kg (3500 lb)	
Weighing display unit	[03- 0]	kg, g	See "11-1. Capacity and minimum display".
	◆ [03- 1]	kg, g, lb, oz, lb-oz	
Power-on-zero range	[04- 0]	±10% of the capacity	OIML R76 / NTEP
	◆ [04- 1]	±50% of the capacity	
Internal use	◆ [05- 0]	Do not change.	
Decimal separator	◆ [06- 0]	. (point)	
	[06- 1]	, (comma)	
Tare clear by ZERO operation	◆ [07- 0]	ZERO does not clear tare weight	OIML R76
	[07- 1]	ZERO clears tare weight	
Tare operation (Net weight calculation)	[08- 0]	Tare weight is rounded to the weight display count	NTEP
	◆ [08- 1]	Internal count is used for TARE weight.	OIML R76
Preset tare function	[09- 0]	Function disabled	
	◆ [09- 1]	Function enabled	
lb-oz unit	[10- 0]	lb-oz disabled	
	◆ [10- 1]	lb-oz enabled	
ZERO operation range	◆ [11- 0]	±2% of the capacity	
	[11- 1]	Up to the capacity	
Display resolution	◆ [12- 0]	"F02" setting specifies the resolution.	
	[12- 1]	Fixed to "F02-0" (1/3,000~1/3,500)	
	[12- 2]	Fixed to "F02-1" (1/6,000~1/7,500)	
	[12- 3]	Fixed to "F02-2" (1/12,000~1/15,000)	
Auto-tare function	[13- 0]	Function disabled	[13-0] deletes "F2 1" ~ "F2 3".
	◆ [13- 1]	Function enabled	

◆ Factory setting

# 7. CALIBRATION

This function adjusts the scale (indicator) for accurate weighing.  
Calibration must be done when the FS-D is initially connected to a load cell (base unit).  
Calibration may also be required according the changes in the environment.

- When the scale (indicator) has been moved.
- When the ambient environment has significantly changed.
- For regular calibration.

Loose the lock screws on the rear side of the display pod, and remove the (CAL) switch cover. The calibration switch inside.

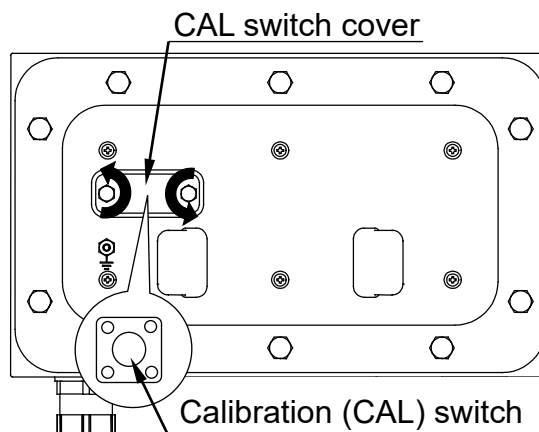

## 7-1. Calibration using a weight

1. Warm up the indicator with a weighing platform connected for at least half an hour.
  - Change the user function setting "FD 1" or place something on the platform to disable the auto power-off function.
  - When turning the power on and the indicator may display -----, press the PRINT/ENT key to proceed to the weighing mode.

2. Press and hold the calibration (CAL) switch until CAL appears, and release the switch.
  - Press and hold the 0 key for about 5 seconds, then you can also enter the calibration mode (when "CO 1-0" is set).
  - Press the ON/OFF key or (CAL) switch to exit without calibration.

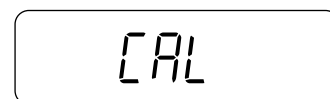

3. Press the PRINT/ENT key, then the gravity acceleration value will be displayed.



- It is not necessary to set the gravity acceleration value when calibrating the indicator with a calibration weight at the place where it is to be used. (See the next section about the gravity acceleration correction.)***

4. Press the PRINT/ENT key, then CAL 0 will be displayed.

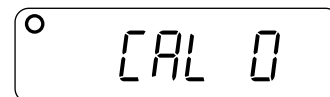

5. Make sure that there is nothing on the platform, and wait until the STABLE indicator turns on.

6. Press the PRINT/ENT key. The indicator inputs the zero point, and the display shows SPn 1 and the weight value for calibration (SPAN calibration).

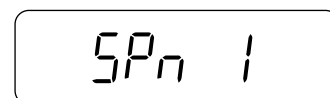

- The weight value is equal to the capacity. When you enter with "kg" or "g" mode, then the value is "kg". Entering with "lb" or "oz", then "lb".***

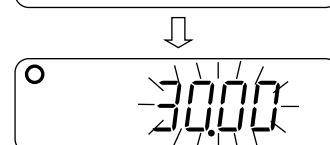

- ❑ If you need ZERO calibration but do not need SPAN calibration, turn the power off to exit from the calibration procedure.

7. To calibrate with a different weight, change the displayed value using the 10-key pad.



- ❑ If you enter the wrong number, press the **C** key. The value returns to the capacity and enter the number again.

8. Place a calibration weight on the platform with the same value as displayed, and wait until the STABLE indicator turns on.

9. Press the **PRINT/ENT** key. The indicator calibrates SPAN and **End** will appear. Remove the weight from the platform, and turn the power off.

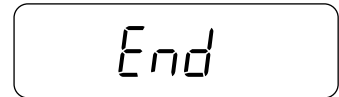

**❑ Note**

**The value set in step 7 will be cleared after the power is switched off.**

**If the indicator will be moved to another location, set the gravity acceleration value for the current location and calibrate the indicator according to the procedure above. See the next section to set the value.**

## 7-2. Gravity acceleration correction

When the indicator will be moved to different place from the calibration location, it should be calibrated using a calibration weight.

But if a calibration weight is not available, the gravity acceleration correction will compensate the indicator. To use this function, set the gravity acceleration value to the value of the location where the calibration will be done. Refer to the gravity acceleration map appended to the instruction manual of the FS-*i* series.

1. At step 3 of the previous section “[7-1. Calibration using a weight](#)”, enter a new value using 10-key pad.



- ❑ The integral part “g” is fixed, enter the value after the decimal point.

- ❑ If you hit the wrong number, press the **C** key. The value returns to the original number. Enter the number again.

2. Press the **PRINT/ENT** key, then **CAL 0** will be displayed.

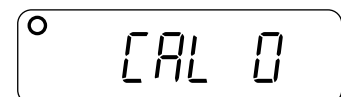

3. Go to step 5 of “[7-1. Calibration using a weight](#)”.

## 8. AUTO-TARE FUNCTION

The FS-D has an auto-tare function to be used with the comparator function enabled. If the weight value is within the OK range and stable for a preset time, then the indicator will automatically tare the weight and show zero. The Function “F22” designates the timing to tare automatically. See “9. ADDITIONAL INFORMATION” about the added F-Function settings related to the auto-tare function.

- To use the auto-tare function, set the function settings below.

F08-1: Compare all weighing data (other settings may be used depending on the application).  
 F21-1: Auto-tare function enabled.  
 F22-0 ~ 9: Select the timing to tare automatically to avoid the wrong tare operation, for example; too early to tare, to take a longer time to go to the next weighing and so on.

- Take-away check weighing:

Take-away check weighing (negative comparison) is the way to compare the negative weight taking away material from a container. Set the Function “F24-1” together with the auto-tare function enabled “F21-1”. In this operation mode, the indicator operates as “take-away the material” → “OK and stable” → “auto-tare” → “take-away the material” → …….

In this setting, the polarity of the target weight and the upper / lower limit weight are ignored and the indicator shows the comparator results as below.



Note To start the take-away check weighing, be sure to use the **TARE** key to tare the weight of the container filled with material. The **ZERO** key may zero the display, and the indicator goes below the zero point by taking out the material. Then, the auto-tare function does not work.

- When the Function “F23-1 Tares the initial (container) weight.” is set:

To start the auto-tare function application, usually the container (filled with material) will be placed on the weighing pan and its weight must be tared using the **TARE** key. When the Function “F23-1” is set, the indicator will tare the initial (container) weight automatically.

Remove all load on the weighing pan to return to the zero point, the tare weight will be automatically cleared. If the indicator could not return to the zero point because of a zero shift, press the **ZERO** key to clear the tare weight.

- If the indicator is equipped with the optional RS-232C interface, the OK weighing data only can be sent out automatically. Set the Function setting “F06-7 Auto-print mode +/- data”.



# 9. ADDITIONAL INFORMATION

This section describes the additional functions and corrections to the instruction manual of FS-*i* series (WM+PD4001332 and 1WMPD4001368) which are common to the FS-D.

## 9-1. F-Function list

The following function settings are added (“11-2. Function list” in WM+PD4001332).

Item	Function number	Description	
Serial interface Data output mode	F06- 5	Multi-connection with print key mode (RS-422/485)	The UFC format is applicable to F06-2 to 4.
	F06- 6	Auto-print mode + data & OK	
	F06- 7	Auto-print mode +/- data & OK	
Zero tracking	F13- 0	Zero tracking OFF	Setting [04-0, F13-2 and 3 cannot be set.
	◆ F13- 1	Zero tracking ON, 0.5d/sec	
	F13- 2	Zero tracking ON, 1.0d/sec	
	F13- 3	Zero tracking ON, 2.0d/sec	
Auto-tare function	◆ F21- 0	Auto-tare function disabled.	
	F21- 1	Auto-tare function enabled.	
Auto-tare timing	F22- 0	Immediately after OK and stable	Timing to tare automatically after the comp. OK and weight stable. To be used with F21-1.
	F22- 1	0.5 sec. after OK and stable	
	◆ F22- 2	1.0 sec. after OK and stable	
	F22- 3	1.5 sec. after OK and stable	
	F22- 4	2.0 sec. after OK and stable	
	F22- 5	2.5 sec. after OK and stable	
	F22- 6	3.0 sec. after OK and stable	
	F22- 7	4.0 sec. after OK and stable	
	F22- 8	5.0 sec. after OK and stable	
	F22- 9	6.0 sec. after OK and stable	
Auto-tare for the initial weight	◆ F23- 0	Function disabled	Automatic operation.
	F23- 1	Tares the initial (container) weight.	
Normal/Negative comparison	◆ F24- 0	Normal comparison	
	F24- 1	Negative comparison for take-away	

◆ Factory setting

## 9-2. OP-03 RS-232C

The followings are the corrections and the additional information for the optional interface (“2-2. OP-03 Specifications” and “2-3. Command Mode” in 1WMPD4001368).

Circuit diagram

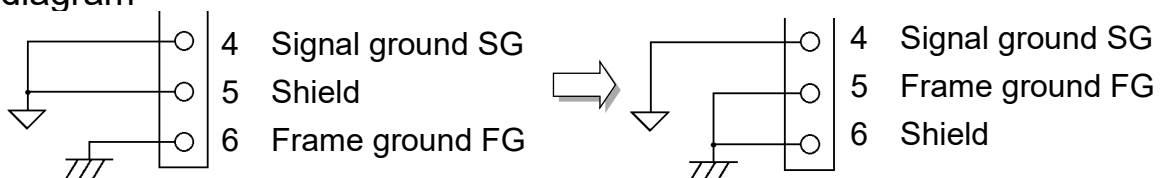



Command 

H	I	,	+	0	0	1	0	0	C <sub>R</sub>	L <sub>F</sub>
---	---	---	---	---	---	---	---	---	----------------	----------------

 Assume 2 decimal place number.

Reply 

H	I	,	+	0	0	1	0	0	C <sub>R</sub>	L <sub>F</sub>
---	---	---	---	---	---	---	---	---	----------------	----------------

 1.00% will be set as LO limit %.



Command 

L	O	,	+	0	0	1	0	0	C <sub>R</sub>	L <sub>F</sub>
---	---	---	---	---	---	---	---	---	----------------	----------------

 Assume 2 decimal place number.

Reply 

L	O	,	+	0	0	1	0	0	C <sub>R</sub>	L <sub>F</sub>
---	---	---	---	---	---	---	---	---	----------------	----------------

 1.00% will be set as LO limit %.

Store the comparator limits into the specified memory number. (No reply for  $F20-1$ .)

Reply 

H	I	,	0	1	,	+	0	0	1	2	0	0	,	+	0	0	0	9	0	0	C <sub>R</sub>	L <sub>F</sub>
---	---	---	---	---	---	---	---	---	---	---	---	---	---	---	---	---	---	---	---	---	----------------	----------------



Reply 

M	L	,	0	1	,	+	0	0	1	2	0	0	,	+	0	0	0	9	0	0	C <sub>R</sub>	L <sub>F</sub>
---	---	---	---	---	---	---	---	---	---	---	---	---	---	---	---	---	---	---	---	---	----------------	----------------

### 9-3. OP-04 RS-422 / 485

The followings are the corrections and the additional information for the optional interface. (“3-2. OP-04 Specifications” in 1WMPD4001368).

Circuit diagram

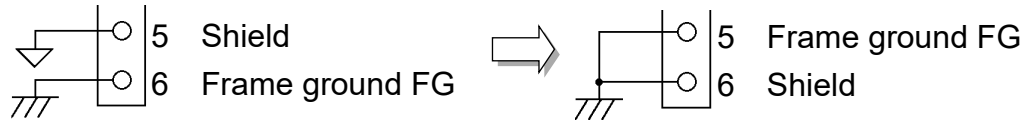

The frame ground and the shield are connected internally and there is no difference between them in use.

### Multi-connection with Print key mode (new function)

This is one of the applications when a PC and more than one FS-D are connected. The indicator will prepare the weighing data by pressing the **PRINT** key first and will send out the prepared data after receiving a command from the PC.

1. Set the Function “ $F05-5$ ” for all of the indicators.
2. Weigh something and wait for the STABLE indicator to turn on (the indicator having  $F18-##$ ).
3. Press the **PRINT** key, the indicator will temporarily store the weight data and turn the PRINT indicator on.
  - The indicator does not accept the **PRINT** key while the PRINT indicator on.
4. Send the “@##S” command to the indicators from the PC.
5. The indicator ( $F18-##$ ) will respond to the command to send the weight data in memory and turn the PRINT indicator off.

The address ## = 23 ( $F18-23$ ).

A request for weight data.

Command 

@	2	3	S	C <sub>R</sub>	L <sub>F</sub>
---	---	---	---	----------------	----------------

Reply 

@	2	3	S	T	,	+	0	0	1	2	.	3	4	5	_	k	g	C <sub>R</sub>	L <sub>F</sub>
---	---	---	---	---	---	---	---	---	---	---	---	---	---	---	---	---	---	----------------	----------------

Reply 

@	2	3	I	C <sub>R</sub>	L <sub>F</sub>
---	---	---	---	----------------	----------------

 The indicator does not have any stored data to send.

While the PRINT indicator is on, the indicator will send back “@##I” to commands other than “@##S” command.

---

## 10. ERROR MESSAGES

---

### Overload error

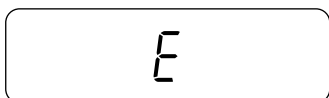

Warning to indicate that an object beyond the weighing capacity has been placed on the weighing pan. Remove the object from the weighing pan.

### Power-on error

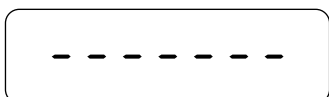

Warning to indicate that an object beyond the power-on zero range (50% of the weighing capacity or 10%) is placed on the weighing platform. Remove the object from the weighing pan.

Pressing the PRINT/ENT key, the indicator will show the weight value without zeroing the indicator.

### Low battery

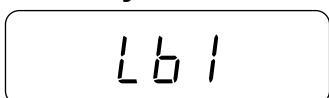

Warning to show that the OP-02 battery is discharged. Immediately connect the power cord to the AC power source to charge the battery. The indicator can be used while the battery is charging (except when the OP-04 is installed).

### CAL error

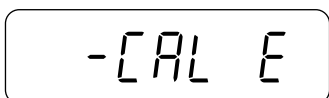

Warning to indicate that the calibration has been canceled because the calibration weight is too light. Check if the calibration weight is correct.

### Other errors

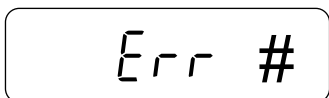

Showing errors inside the indicator. Check the connection between the indicator and platform, and turn the power off and on with nothing on the weighing platform. (# signifies an error number.)

When the indicator does not recover from errors or shows other errors, contact your local A&D dealer.

# 11. SPECIFICATIONS

## 11-1. Capacity and minimum display

[02]- setting		0*	1	2	3	4	5	6	7
kg	Capacity	6	15	30	60	150	300	600	1500
	Min. display	0.002*	0.005	0.01	0.02	0.05	0.1	0.2	0.5
		0.001	0.002	0.005	0.01	0.02	0.05	0.1	0.2
		0.0005	0.001	0.002	0.005	0.01	0.02	0.05	0.1
g	Capacity	6000	15000	30000	NA	NA	NA	NA	NA
	Min. display	2*	5	10					
		1	2	5					
		0.5	1	2					
lb	Capacity	15	35	70	150	350	700	1500	3500
	Min. display	0.005*	0.01	0.02	0.05	0.1	0.2	0.5	1
		0.002	0.005	0.01	0.02	0.05	0.1	0.2	0.5
		0.001	0.002	0.005	0.01	0.02	0.05	0.1	0.2
oz	Capacity	240	560	1120	2400	5600	11200	NA	NA
	Min. display	0.1*	0.2	0.5	1	2	5		
		0.05	0.1	0.2	0.5	1	2		
		0.02	0.05	0.1	0.2	0.5	1		
lb-oz	Capacity	15	35	70	NA	NA	NA	NA	NA
	Min. display	0.1	0.1	0.1					

\*: Factory setting

NA: Not Available

## 11-2. Specifications

Input sensitivity	0.2 $\mu$ V / d (d: the smallest Min. display of kg)	
Input signal range	0 mV ~ 13 mV	
Load cell excitation voltage	5 V DC $\pm$ 5% (no remote sensing)	
Load cell drive capacity	Up to 4 x 350 ohm load cells	
Temperature coefficient	Zero	$\pm$ (0.2 $\mu$ V $\pm$ 0.001% of zero adjustment voltage) / $^{\circ}$ C (typ.)
	Span	$\pm$ 0.001% / $^{\circ}$ C of reading (typ.)
Non-linearity	$\pm$ 0.01 % of full scale	
Display	7 segment LCD display (Character height 18.6 mm) with backlight 60 segment analog sweep display with backlight	
Display update	Approximately 20 times per second	
Operating temp.	-10 $^{\circ}$ C ~ 40 $^{\circ}$ C / 14 $^{\circ}$ F ~ 104 $^{\circ}$ F, less than 85% R.H.	
Power supply	AC main (100V ~ 240 V, 50/60 Hz) or SLA Battery (option)	
Dimension	250 (W) x 202 (D) x 266 (H) mm / 9.8 (W) x 8.0 (D) x 10.5 (H) in.	
Weight	Approximately 2.7 kg	

### 11-3. Options

- OP-02 (HC-02i)
- OP-03 (FS-03i)
- OP-04 (FS-04i)

- SLA Battery (Yuasa Battery NP4-6 recommended.)
- RS-232C + Comparator Relay Output (See note.)
- RS-422/485 + Comparator Relay Output (See note.)

Note OP-03 and OP-04 cannot coexist.

### 11-4. Dimensions

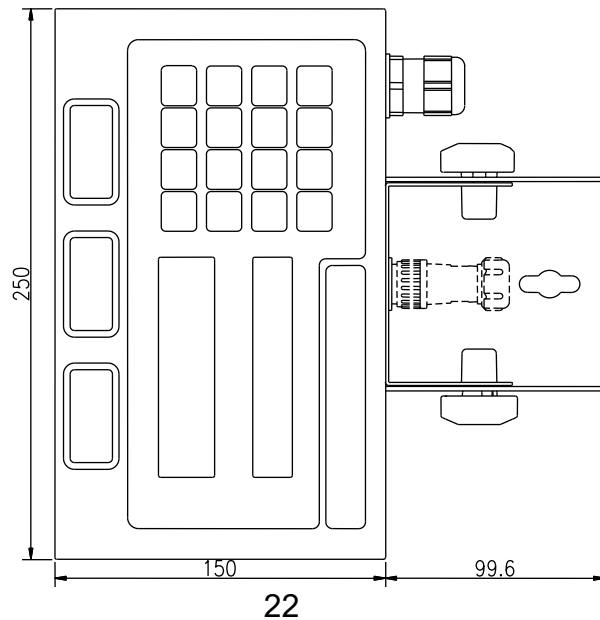
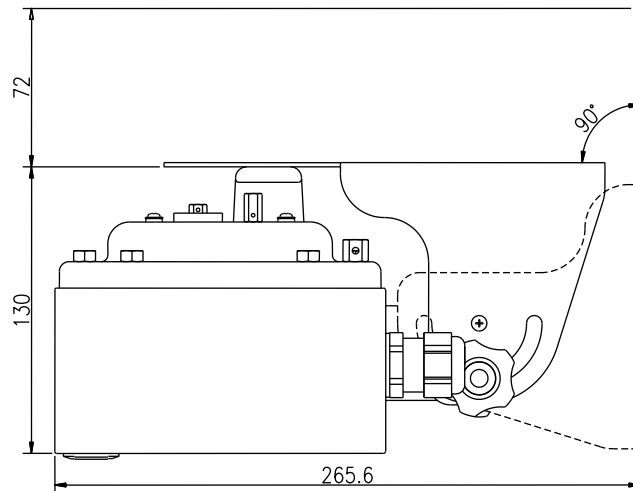
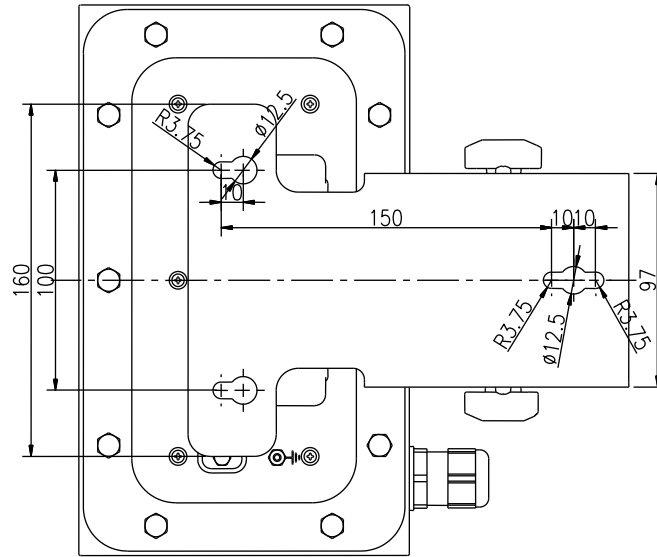

Unit: mm

THIS PAGE INTENTIONALLY LEFT BLANK



### **A&D Company, Limited**

3-23-14 Higashi-Ikebukuro, Toshima-ku, Tokyo 170-0013, JAPAN  
Telephone: [81] (3) 5391-6132 Fax: [81] (3) 5391-1566

### **A&D ENGINEERING, INC.**

47747 Warm Springs Blvd, Fremont, California 94539, U.S.A.  
Tel: [1] (800) 726-3364 Weighing Support:[1] (888) 726-5931 Inspection Support:[1] (855) 332-8815

### **A&D INSTRUMENTS LIMITED**

Unit 24/26 Blacklands Way, Abingdon Business Park, Abingdon, Oxfordshire OX14 1DY United Kingdom  
Telephone: [44] (1235) 550420 Fax: [44] (1235) 550485

### **A&D AUSTRALASIA PTY LTD**

32 Dew Street, Thebarton, South Australia 5031, AUSTRALIA  
Telephone: [61] (8) 8301-8100 Fax: [61] (8) 8352-7409

### **A&D KOREA Limited**

한국에이.엔.디(주)  
서울특별시 영등포구 국제금융로6길33 (여의도동) 맨하탄빌딩 817 우편 번호 07331  
( 817, Manhattan Bldg., 33. Gukjegeumyung-ro 6-gil, Yeongdeungpo-gu, Seoul, 07331 Korea )  
전화: [82] (2) 780-4101 팩스: [82] (2) 782-4264

### **OOO A&D RUS**

### **ООО "ЭЙ энд ДИ РУС"**

Почтовый адрес:121357, Российская Федерация, г.Москва, ул. Верейская, дом 17  
Юридический адрес: 117545, Российская Федерация, г. Москва, ул. Дорожная, д.3, корп.6, комн. 86  
( 121357, Russian Federation, Moscow, Vereyskaya Street 17 )  
тел.: [7] (495) 937-33-44 факс: [7] (495) 937-55-66

### **A&D Instruments India Private Limited**

### **ऐ&डी इन्स्ट्रुमेंट्स इण्डिया प्रा० लिमिटेड**

D-48, उद्योग विहार , फेस -5, गुडगांव - 122016, हरियाणा , भारत  
( D-48, Udyog Vihar, Phase-V, Gurgaon - 122016, Haryana, India )  
फोन : [91] (124) 4715555 फैक्स : [91] (124) 4715599

### **A&D SCIENTECH TAIWAN LIMITED. A&D台灣分公司 艾安得股份有限公司**

台灣台北市中正區青島東路5號4樓  
( 4F No.5 Ching Tao East Road, Taipei Taiwan R.O.C. )  
Tel : [886](02) 2322-4722 Fax : [886](02) 2392-1794

### **A&D INSTRUMENTS (THAILAND) LIMITED**

### **บริษัท เอ แอนด์ ดี อินสตรูमेंท์ (ไทยแลนด์) จำกัด**

168/16 หมู่ที่ 1 ตำบลรังสิต อำเภอธัญบุรี จังหวัดปทุมธานี 12110 ประเทศไทย  
( 168/16 Moo 1, Rangsit, Thanyaburi, Pathumthani 12110 Thailand )  
Tel : [66] 20038911