

FC SERIES

COUNTING SCALES

INSTRUCTION MANUAL

owners-FC-v.1.d 90.01.17 BLP

HIGH RESOLUTION COUNTING SCALES

AND *Mercury*
PTY.LTD.

A&D MERCURY PTY. LTD.
32 Dew St, Thebarton, S.A., 5031

Telephone (08) 352 3033

Facsimile (08) 352 7409

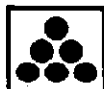

Contents

Specifications and Options	page	1•4
Introduction		
Setting Up Your Scale	page	1•6
Best Conditions for Weighing	page	1•7
How the Scale Counts	page	1•7
Standby and Operations Mode	page	1•8
F-Function Parameters	page	1•8
ACAI Automatic Counting Accuracy Improvement ...	page	1•8
Simple Operations Mode	page	1•9
kg or lb Weighing Units (USA version only)	page	1•9
Last Unit Weight Used Feature	page	1•10
Front Panel	page	1•11
Basic Operation		
To Start Counting	page	2•2
Unit Weight by a Sample, Simplified Operation	page	2•3
5, 25, 50 or 100 Sample Size	page	2•4
User Set Sample Size	page	2•5
Unit Weight By Keyboard	page	2•6
Unit Weight By ID Number	page	2•7
Using Tare		
Using the TARE Key (Direct Subtraction)	page	3•2
Using the KEYBOARD TARE Key	page	3•3
To Clear Tare	page	3•4
Store Unit Weight (By ID Numbers)		
Store Unit Weight Into Memory	page	4•2
Clearing A Memorized Unit Weight	page	4•3
Tare Weight & Unit Weight Memorized	page	4•4
Using Tare		
Adding Using the M+ Key	page	5•2
To Erase The Last M+ Addition	page	5•3
Automatic M+ Accumulation Mode	page	5•3
Viewing The M+ Total	page	5•4
To Clear The Last M+ Addition	page	5•4
Comparator Function		
The Comparator Function	page	6•2
To Set the Comparator	page	6•2

F-Functions

F-Function Parameters	page	7•2
To Change or View F-Function Settings	page	7•2
F-Function Overview Listings	page	7•4
Changing F-Functions (Diagram)	page	7•6
F-Functions	page	7•7

OP-01 Barcode Reader

About OP-01.....	page	8•2
Using OP-01.....	page	8•2

OP-02 NiCd Battery

Using OP-02.....	page	9•2
------------------	------	-----

OP-03 Serial Interface

OP-03 Includes.....	page	10•2
Installation	page	10•2
OP-03 Specifications.....	page	10•2
Data Output Mode.....	page	10•4
Connecting the AD-8117 Printer.....	page	10•5
Connecting the AD-8117A Printer	page	10•6
OP-03 Computer connection	page	10•8

OP-04 Display Arm

OP-04 Installation.....	page	11•2
-------------------------	------	------

OP-05 Remote Scale Connector

OP-05 Remote Scale Connector.....	page	12•2
OP-05 Installation.....	page	12•2
Remote Scale Connection.....	page	12•3
Load Cell Connection	page	12•3

OP-07 Display Pod Wall Mounting Kit

OP-08 Display Pod Extension Cable

OP-07 Wall Mounting Kit.....	page	14•2
OP-08 2m Extension Cable.....	page	14•3
OP-08 Installation.....	page	14•3

Appendices

Appendix A – Center of Zero	page	A•2
Appendix B – "Add" Display	page	B•1
Appendix C – ACAI	page	C•1
Appendix D – Calibration	page	D•1



Warranty

Warranty rights vary from country to country but it is the general intention of A&D Co., Ltd., to offer customers a one year warranty on this product from the day it is purchased. In some countries consumer protection legislation states that your dealer is responsible for offering a warranty and under these circumstances please refer to your local dealer.

In the U.S.A. the product (if defective) should be returned, freight prepaid by the customer, to A&D Engineering Inc. in California and in Europe the product can be returned freight prepaid to A&D Instruments GmbH in Frankfurt, West Germany. Elsewhere the product can be returned to A&D Co., Ltd. in Japan. In any event please contact your nearest A&D office, before shipping, to confirm that the product is covered by this warranty. Simple repairs can be carried out by your local dealer under warranty and this may be the fastest method of solving your problem.

This warranty only applies to product failures due to defective materials and/or workmanship. This warranty will be rendered invalid if, upon inspection, it is found that the product was: Abused; used for a purpose for which it was not designed; mishandled; placed in a hostile environment; repaired by unauthorized personnel; improperly installed or not adjusted in accordance with instructions given in this manual.

If repair under warranty is confirmed by A&D, then the product will be repaired (or replaced, at the discretion of A&D) and then returned to the customer at no extra cost.

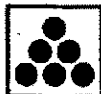

Compliance with FCC Rules

Please note that this equipment generates, uses and can radiate radio frequency energy. This equipment has been tested and has been found to comply with the limits of a Class A computing device pursuant to Subpart J of Part 15 of FCC rules. These rules are designed to provide reasonable protection against interference when equipment is operated in a commercial environment. If this unit is operated in a residential area it might cause some interference and under these circumstances the user would be required to take, at his own expense, whatever measures are necessary to eliminate the interference.

(FCC = Federal Communications Commission in the U.S.A.)



Specifications & Options

MODEL	FC-500	FC-1000	FC-2000	FC-5000	FC-10K	FC-20K	FC-31K	FC-50K
Capacity (kg)	0.5kg	1kg	2kg	5kg	10kg	20kg	31kg	50kg
Resolution (g)	0.05g	0.1g	0.2g	0.5g	1g	2g	5g	5g
Capacity (lb)	1 lb	2 lb	5 lb	10 lb	20 lb	50 lb	75 lb	100lb
Resolution (lb)	0.0001 lb	0.0002 lb	0.0005 lb	0.001 lb	0.002 lb	0.005 lb	0.01lb	0.01lb
Sample Size	10 pieces normal - 5,25,50, 100 or random number, user selectable							
Min. Unit Weight (1/50,000 mode)	0.01g	0.02g	0.04g	0.1g	0.2g	0.4g	0.5g	1g
Min. Unit Weight (1/500,000 mode)	0.001g	0.002g	0.004g	0.01g	0.02g	0.04g	0.1g*	0.1g
Pan Size (mm)	205 x 152		315 x 270					
Pan Size (inches)	8.1 x 6.0		12.4 x 10.6					
Internal Resolution	1/500,000 (*FC-31K-1/300,000)							
Sensitivity Drift	20ppm/°C (5°C ~ 35°C)							
Operating Temp.	-5°C ~ 40°C							
Display	Fluorescent blue - Weight (5 digits), Unit Weight (5 digits), Count (5 digits*) *Normally 5 digits, but max. is 6 digits. In this case, Unit Weight section turns OFF.							
Power	100, 120, 220, 240 VAC 50/60 Hz (AC Adapter) or optional NiCd Battery pack - Operating time approx. 10 hours (main scale only)							
Weight Sensor	Load Cell							
Max. Count Pieces	Up to 999,999 pieces (accumulated)							
Dimension	330(W) x 432(D) x 93(H) mm 13(W) x 17(D) x 3.7(H) inch							

- Options**
- OP-01 Bar Code Reader
 - OP-02 NiCd Battery Pack
 - OP-03 RS-232C/ Current Loop/ Bar Code/ Comparator Out
 - OP-04 Display Arm
 - OP-05 Remote Scale Connector
 - OP-07 Wall Mounting Kit
 - OP-08 Extension Cable (2m)
 - OP-09 Remote Platforms (10kg - 1.2t)
 - OP-21 - 26 AC Adaptors (100V - 240V)



FC Counting Scales

abc...

Introduction



Setting Up Your Scale

- Unpack the scale carefully and keep the packing material if you are likely to transport the scale again in the future.
- In the carton you should find this manual plus:
 - The Counting Scale.
 - An AC/DC adaptor (check that the AC input rating is correct).
 - A spare fuse (1A slow blow).

1

Remove the protective packing materials from around the scale and in between the pan and scale casing.

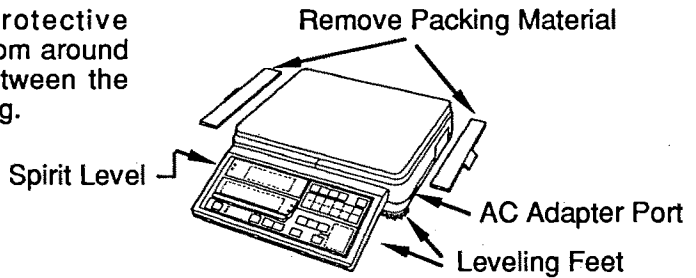

2

Place the scale on a suitable weighing surface (see BEST CONDITIONS FOR WEIGHING, next page) and turn the adjustable feet until the spirit level shows that the scale is level.

3

Plug in the AC/DC adaptor. The AC input requirements could be 100, 120, 220 or 240 Volts (50/60Hz) depending on the area in the world so please check that the adaptor is correct. The adaptor's DC output should be about 12 Volts (please note that an alternative 12V DC power supply might not be stable enough for this scale). Earth the chassis if you think static electricity may be a problem.

▣ **The Display comes ON**

After running through a self-check that will show various segments, the weighing display will appear.

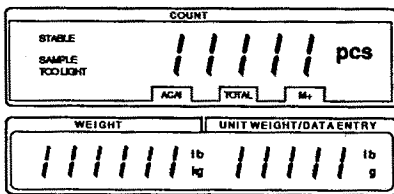

Scale runs a Self Check
'11111' → '99999'

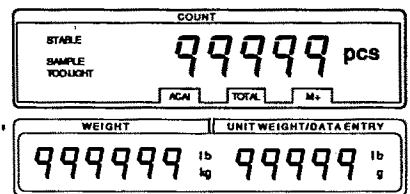

4

Please leave the scale switched on to "warm-up" for at least thirty minutes while the AC adaptor is connected before use.



STANDBY
OPERATE

If desired: press the **STANDBY OPERATE** key to turn the display OFF. Remember that the scale will always be warmed up as long as the AC adaptor is connected.

- ▣ *STANDBY is a normal state for the scale – it does no harm, but keeps the scale always ready for use.*



Best Conditions For Weighing

- The Scale must be level (check the spirit level on the Scale).
- Best temperature is about 20°C/68°F at about 50% Relative Humidity.
- The weighing room should be kept clean and dry.
- The weighing table must be of a solid construction.
- Corners of rooms are best as they are less prone to vibrations.
- Don't install the scale near heaters or air conditioners.
- Don't install the scale in direct sunshine.
- Try to ensure a stable AC power supply when using an adaptor.
- Keep equipment containing magnets away from the scale.
- Warm-up the scale before use or leave it on standby overnight.
- Earth the scale chassis for electrostatic discharge if the weighing conditions warrant.



Calibration



If your dealer has not already done so already, calibration of the FC is required when the scale is initially installed, or if a remote scale is added. Please see APPENDIX D for more calibration information.



How the Scale Counts



The FC scale counts by knowing the weight of one piece, called the **unit weight**, then applying it to the total weight of what you are trying to count. For example, if you are weighing bolts that have a unit weight of 1g and the batch weighs 100g, then the scale will tell you that you have 100 pieces. Sounds simple, but things rarely weigh exactly 1g and piece variations can add errors - plus you often have containers to hold the pieces and that weight must be disregarded. The FC takes all the trouble out of counting and has many features that will make repeated counting easy and precise.

- There are three main methods to enter a unit weight and start counting:

1

*Unit Weight
by a
Sample*

You may use the Simplified Operation – press the **[SAMPLE]** key, put 10 sample pieces on the weighing pan and press the **[ENTER]** key – or select other sample sizes.

2

*Unit Weight
by the
Keyboard*

You may enter the unit weight digitally by pressing the **[KEY BOARD]** key, then use the keyboard  to enter the unit weight, and press the **[ENTER]** key.

3

*Unit Weight
by an
ID. Number*

You may store unit weights by an ID number and then recall them using the **[ID]** key or the optional Bar Code Reader. 



Standby and Operating Mode

The FC scale has two main modes: *Standby Mode* and *Operating Mode*. When the scale has power supplied to it, either by the AC Adaptor or the Battery Pack, and the display is OFF – it is in Standby Mode. If the display is ON, then the scale is in Operating Mode.

In day-to-day operation, Standby Mode is normal when the scale is not in use. This keeps a very small current going to the weighing mechanism keeping it warmed-up, and also keeps the scale's temporary memory active. If the scale is not going to be used for a long period of time, then it may be appropriate to disconnect the main power.

- Use the **STANDBY OPERATE** key to turn the display ON or OFF. When the scale is in Standby mode, a period appears in the WEIGHT Display as an indicator.

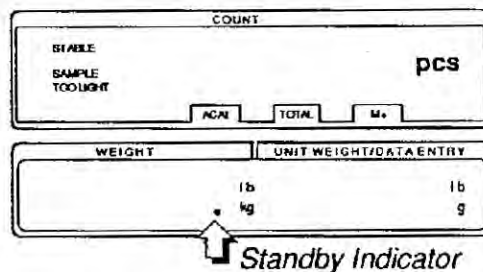

F-Function Parameters

The FC scale has a number of software parameters that enable you to select the best weighing features for your needs. These settings control for example the comparator, and how the balance responds to various operations and options. F-Functions are listed on page 7•4 and can be set using the method as shown in the diagram CHANGING F-FUNCTIONS, page 7•6. The individual settings for each group are detailed in the following section THE F-FUNCTIONS, page 7•7.



ACAI Automatic Counting Accuracy Improvement

The ACAI™ (Automatic Counting Accuracy Improvement) function is an exclusive A&D software advancement that re-calculates the unit weight as more pieces are added, to improve count accuracy. This is a very useful function when counting light items, especially when there is a large number to be counted.

When the scale calculates unit weight from sample pieces, the more sample pieces that are used, the greater the accuracy. For example: let's say that you use 10 pieces (Simplified Operation) as your sample and the unit weight calculated by the scale from your sample is 1g. Using the ACAI feature, after loading on 200 pieces, the scale determines that the average unit weight is really 0.98g instead of 1g. This is improved accuracy and could make a big difference when you are counting thousands of pieces.

To get highly accurate counting results, you need to stay within the ACAI counting range as you add more pieces (see Appendix C). But this is easy to do and only needs to be done once, up to 200 pieces. After that, the ACAI remembers the most accurate unit weight.



Simple Operations Mode



If desired, the FC scale can be set in a Simple Operations Mode. In this mode only front panel keys that would be used in simple counting operations are active, all others will not operate. The following keys are active in Simple Operations Mode:

Keys that will operate in Simple Operations Mode:

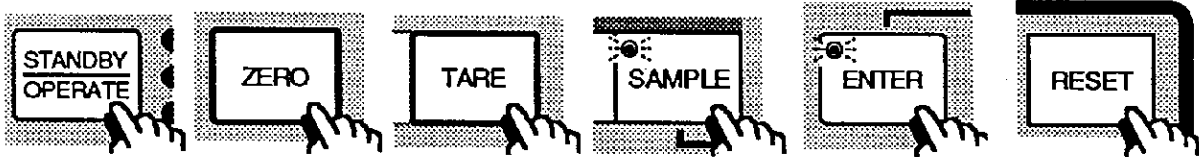

- ▶ If you would like to use this Simple Operations Mode, F-Function F-1-1 needs to be set at "1", see page 7-7.



kg or lb Weighing Units

USA Version
ONLY



The FC scale can weigh and register the unit weight in pounds or kilograms (it comes set to pounds 'lb'). When you switch between the weighing units, the LEDs on the UNIT WEIGHT display will show the current weighing unit, and any weight amounts being used are also converted.

- ▶ To change the weighing units between pounds and kilograms, see F-Function F-8-1. Set at "0" for kg; or at "1" for lb (see page 7-14).

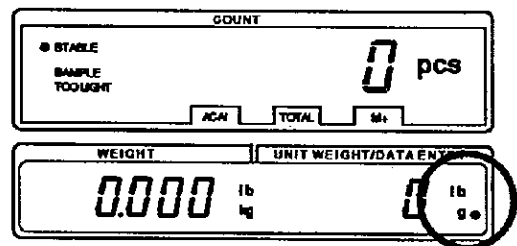



Last Unit Weight Used Feature



As you will learn later in the BASIC OPERATIONS section, there are a number of ways to register a unit weight to count. The FC scale has a feature to keep the last unit weight used in memory. This can be handy if you turn the scale display OFF and then want to return to the same unit weight, or you accidentally clear the unit weight by pressing the **RESET** key.

When a Unit Weight is registered it is automatically placed in the "id 000" ID and remains there until a new unit weight is entered, or the power is disconnected. It can be recalled by the following:

1

- ▶ When the three **UNIT WEIGHT BY** LED's are blinking  at display ON, or if the **RESET** key has been pressed;



2

- ▶ Press the **ID** key.
- 'id000' will appear in the DATA ENTRY display with the  blinking.

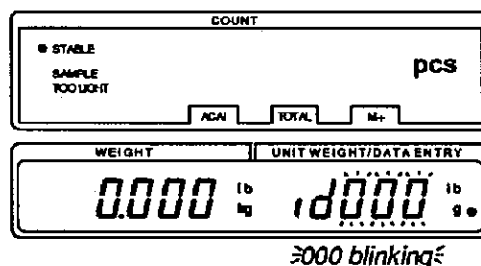
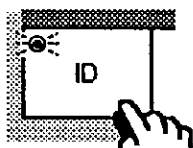

3

- ▶ Press the **ENTER** key.
- The scale will recall the previous **UNIT WEIGHT** display. For example: '12g'.

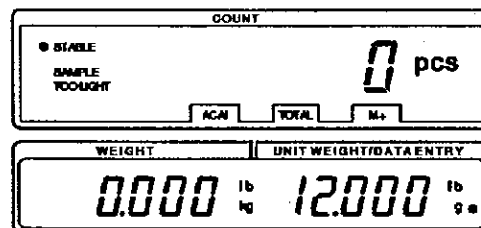
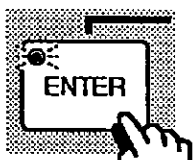

Automatic Last Unit Weight Used



When you turn the display ON, the scale can automatically recall the last Unit Weight used from memory, if desired.

- ▶ If you would like set the scale to recall the last Unit Weight used when the display is turned ON, then F-Function **F-1-4** needs to be set at "1", see page 7-8.

Front Panel Overview

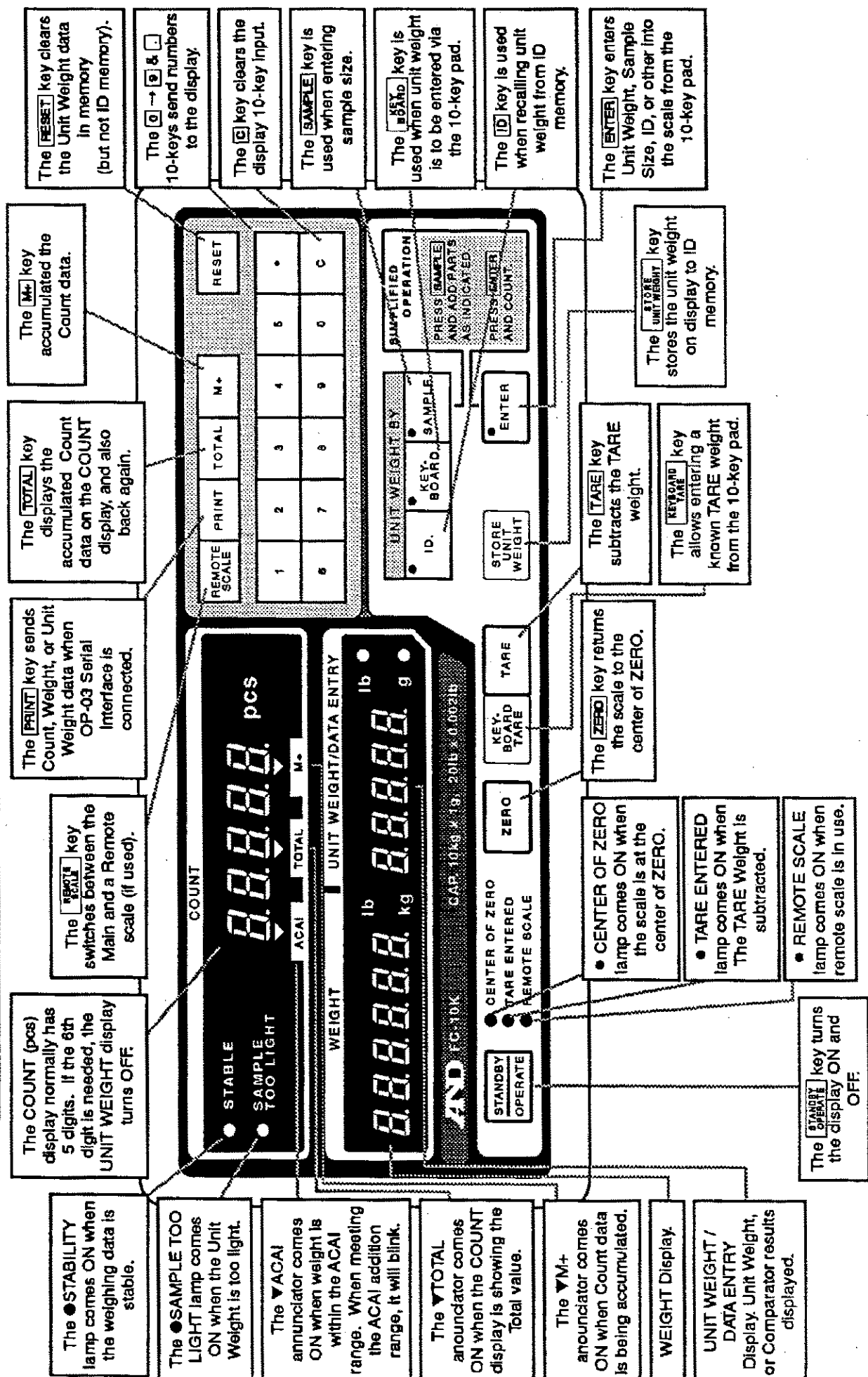

The **STABILITY** lamp comes ON when the weighing data is stable.

The **●SAMPLE TOO LIGHT** lamp comes ON when the Unit Weight is too light.

The **▼ACAI** annunciator comes ON when weight is within the ACAI range. When meeting the ACAI addition range, it will blink.

The **▼TOTAL** annunciator comes ON when the COUNT display is showing the Total value.

The **▼M+** annunciator comes ON when Count data is being accumulated.

WEIGHT Display.

UNIT WEIGHT / DATA ENTRY Display. Unit Weight, or Comparator results displayed.

The **●COUNT (pcs)** display normally has 5 digits. If the 6th digit is needed, the **UNIT WEIGHT** display turns OFF.

The **RESCALE** key switches between the Main and a Remote scale (if used).

The **PRINT** key sends Count, Weight, or Unit Weight data when OP-03 Serial Interface is connected.

The **TOTAL** key displays the accumulated Count data on the COUNT display, and also back again.

The **M+** key accumulated the Count data.

The **RESET** key clears the Unit Weight data in memory (but not ID memory).

The **0 → [0] & [.]** 10-keys send numbers to the display.

The **[C]** key clears the display 10-key input.

The **[SAMPLE]** key is used when entering sample size.

The **[KEYBOARD]** key is used when unit weight is to be entered via the 10-key pad.

The **[ID]** key is used when recalling unit weight from ID memory.

The **[ENTER]** key enters Unit Weight, Sample Size, ID, or other into the scale from the 10-key pad.

The **[STORE UNIT WEIGHT]** key stores the unit weight on display to ID memory.

The **[TARE]** key subtracts the TARE weight.

The **[KEYBOARD TARE]** key allows entering a known TARE weight from the 10-key pad.

The **[ZERO]** key returns the scale to the center of ZERO.

- **CENTER OF ZERO** lamp comes ON when the scale is at the center of ZERO.
- **TARE ENTERED** lamp comes ON when the TARE Weight is subtracted.
- **REMOTE SCALE** lamp comes ON when remote scale is in use.

The **[STANDBY OPERATE]** key turns the display ON and OFF.

The **[SAMPLIFIED OPERATION]** section includes:

- UNIT WEIGHT BY ID.** PRESS [SAMPLE] AND [ADDPARTS] AS INDICATED.
- STORE UNIT WEIGHT.** PRESS [ENTER] AND [COUNT].



FC Counting Scales

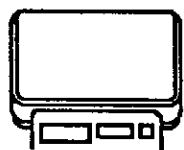

Basic Operations



To Start Counting

STANDBY
OPERATE

RESET

1

- ▶ If the display is not ON, press the **STANDBY OPERATE** key to turn it ON.
- The display will blank for a moment.
- Then, the display will show zero.
- ⚠ If the WEIGHT display is not at zero, please see Appendix A.
- The weighing unit lamp will light, and the STABLE lamp should come ON indicating that the scale is stable and ready.
- ⚠ If the STABLE lamp does not come ON, please adjust the environmental conditions until stability is reached.

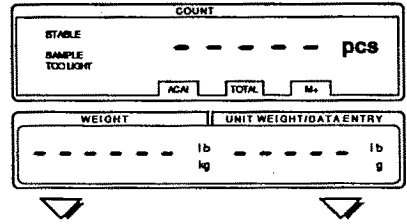

Stability
Lamp

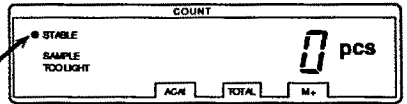

Weighing Unit Lamp

2

- The three LED's on the **UNIT WEIGHT BY** keys will blink. This is to prompt you to select a method for entering a unit weight for operation.
- ▶ Select one of the ways to enter or recall the unit weight (the weight of one of what you are weighing), and see the page noted for more instructions.

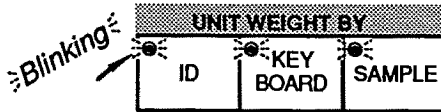

▶ By Stored ID Number...p. 2•7

▶ By Using the 10-key pad...p. 2•6

▶ By Using a Sample:

- Simplified Operationp. 2•3
- 5, 25, 50 or 100 Samplep. 2•4
- User Set Sample Size.....p. 2•5



You can return to this point at any time during operation by pressing the **RESET** key.





Unit Weight By a SAMPLE

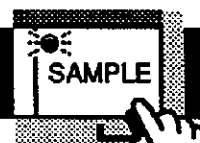

Simplified Operation

1

- The three **UNIT WEIGHT BY** LED's should be blinking at this point, if not, see p. 2-2.
- ▣ If you are going to use a TARE container - place it on the weighing pan now.

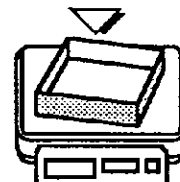

2

- ▣ Press the **SAMPLE** key.
- Any TARE container will automatically TARE.
- The display will show "Add 10 pcs".

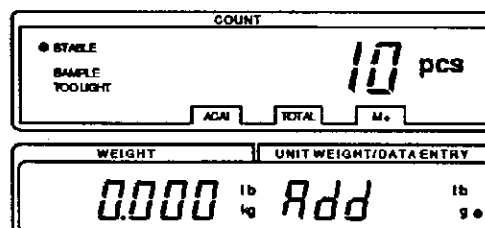
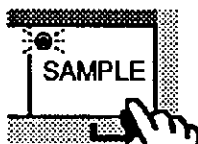

⚠ If WEIGHT ↑ isn't zero, see Appendix A.

3

- ▣ Place 10 sample pieces on the weighing pan (or in the tared container).
- The weight of all 10 pieces will be displayed.

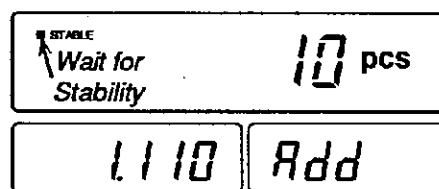
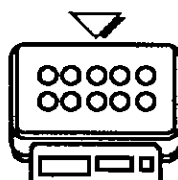

4

- ▣ When the scale is stable, press the **ENTER** key.
- The COUNT display will blank for a moment while calculating the unit weight.

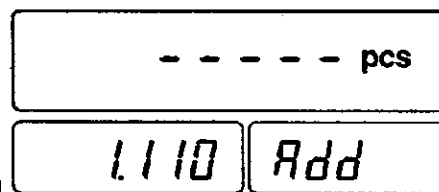
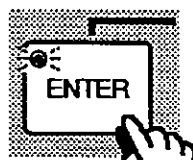

- After a moment the display will show the:
 - ▣ COUNT: 10 pcs.
 - ▣ Total WEIGHT: 1.110kg.
 - ▣ UNIT WEIGHT: 111g.

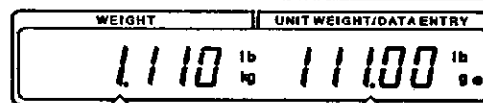
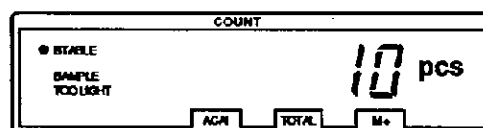

Total Weight
The weight of all the sample pieces

Unit Weight
The calculated weight of one unit

- ⚠ At this point the scale may decide that 10 pieces isn't a large enough sample size for accurate counting. If you see the "Add" display again, then add the additional number of sample pieces displayed. See Appendix B.

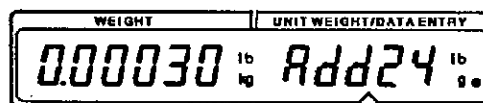

- ▣ You can ignore the "Add" message and continue counting by pressing the **ENTER** key. However, the results may not be accurate. See Appendix B and F-1-2, p. 7-7.

5

- ▣ You may now begin counting operations for pieces of the same weight.
- ▣ Please see APPENDIX C for information concerning the ACAI counting accuracy function.

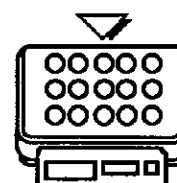



5, 25, 50 or 100 Sample Size

1

- The three **UNIT WEIGHT BY** LED's should be blinking $\Rightarrow \Leftarrow$ at this point, if not, see p. 2•2.
- ▣ If you are going to use a TARE container - place it on the weighing pan now.



2

- ▣ Press the **[SAMPLE]** key.
- Any TARE container will automatically TARE.
- The display will show "Add 10 pcs".

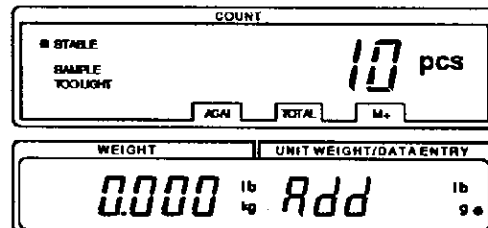
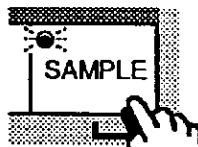

⚠ If WEIGHT ↑ isn't zero, see Appendix A.

3

- ▣ Press the **[SAMPLE]** key to go through the count sizes. Select a sample size: of 5, 25, 50, or 100 pieces.
- ▣ The larger the sample size, the more accurate unit weight registered.
- For example, let's select a sample size of 50.

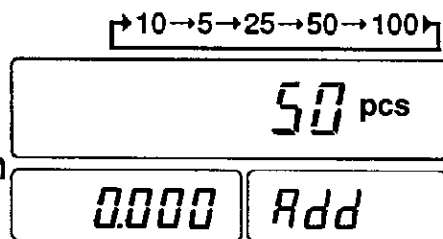
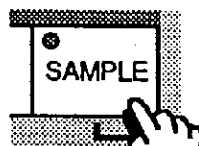

4

- ▣ Place the selected number of sample pieces on the weighing pan (or in the tared container).
- The weight of the pieces will be displayed.

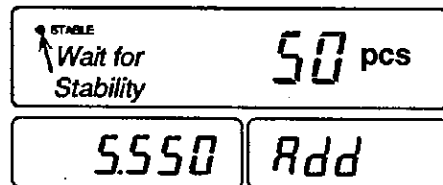
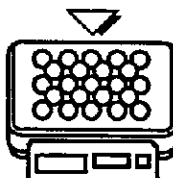

5

- ▣ When the scale is stable, press the **[ENTER]** key.
- The COUNT display will blank for a moment while calculating the unit weight.

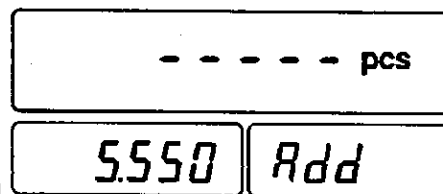
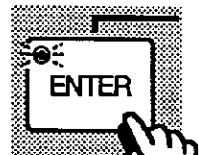

- After a moment the display will show the:
 - ▣ COUNT: 50 pcs.
 - ▣ Total WEIGHT: 5.550kg.
 - ▣ UNIT WEIGHT: 111g.

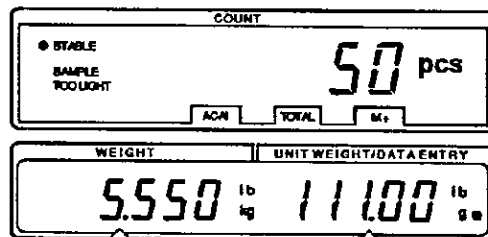

⚠ If the "Add" display appears again, then the sample size isn't large enough for accurate counting - add the additional number of sample pieces, or see Appendix B.

Total Weight
The weight of all the sample pieces

Unit Weight
The calculated weight of one unit

6

- ▣ You may now begin counting operations for pieces of the same weight.
- ▣ Please see APPENDIX C for information concerning the ACAI counting accuracy function. **[V]**

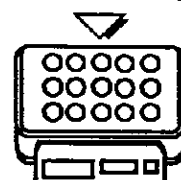

User Set Sample Size

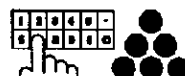

- The three **UNIT WEIGHT BY** LED's should be blinking at this point, if not, see p. 2•2.
 - ☑ If you are going to use a TARE container - place it on the weighing pan now.

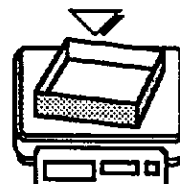

- ☑ Press the **SAMPLE** key.
 - Any TARE container will automatically TARE.
 - The display will show "Add 10 pcs".

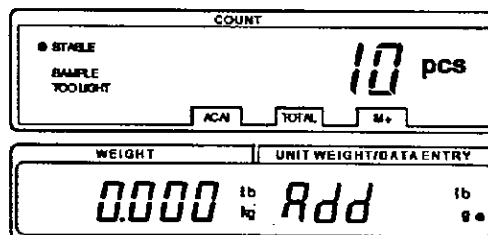
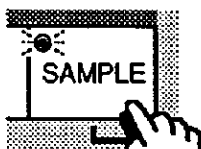

⚠ If WEIGHT ↑ isn't zero, see Appendix A.

- ☑ Use the **0** → **9** 10-key pad keys to display the sample size desired.
 - ☐ If you hit the wrong key, press the **C** key to clear and start again.
 - For example, let's select a sample size of 20.

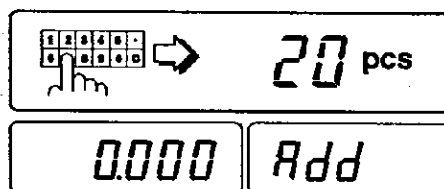
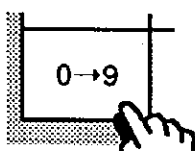

- ☑ Place the selected number of sample pieces on the weighing pan (or in the tared container).
 - The weight of the pieces will be displayed.

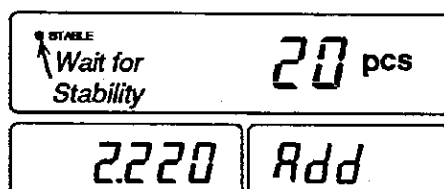
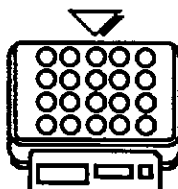

- ☑ When the scale is stable, press the **ENTER** key.
 - The COUNT display will blank for a moment while calculating the unit weight.

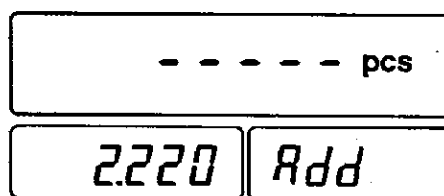
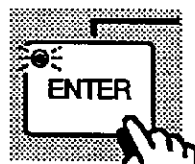

- After a moment the display shows:

- ☐ COUNT: 20 pcs.
- ☐ Total WEIGHT: 2.220kg.
- ☐ UNIT WEIGHT: 111g.

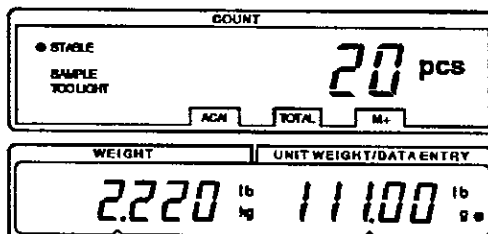

- ⚠ If the "Add" display appears again, then the sample size isn't large enough for accurate counting - add the additional number of sample pieces, or see Appendix B.

Total Weight
The weight of all the sample pieces

Unit Weight
The calculated weight of one unit

- ☑ You may now begin counting operations for pieces of the same weight.
 - ☐ Please see APPENDIX C for information concerning the ACAI counting accuracy function.

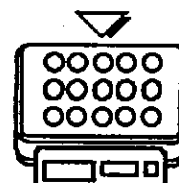



Unit Weight By KEYBOARD



1

- The three **UNIT WEIGHT BY** LED's should be blinking at this point, if not, see p. 2-2.
- ▣ If you are going to use a TARE container - place it on the weighing pan now.



2

- ▣ Press the **KEY BOARD** key.
- The **UNIT WEIGHT** display and the **ENTER** key LED will blink.

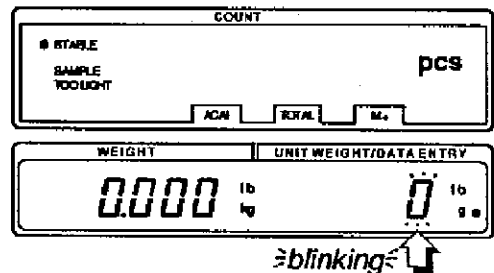
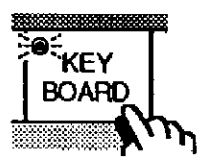

3

- ▣ Use the **0 → 9** & **.** 10-key pad keys to display the Unit Weight.
- ▣ If you hit the wrong key, press the **C** key to clear and start again.
- For example, let's select a Unit Weight of 32g.

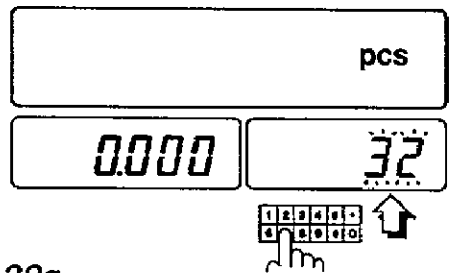
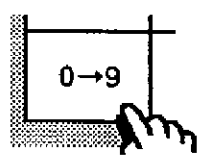

4

- ▣ Press the **ENTER** key.
- The **COUNT** display will show **0** and 32g will have been entered as the Unit Weight.

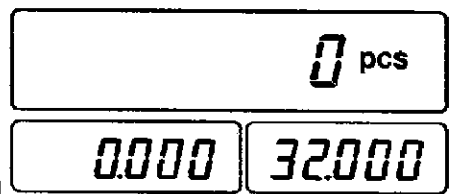
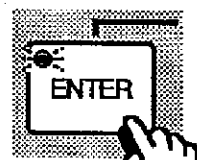

- ⚠ If the Unit Weight entered is too light, **"Lo ut"** (low unit weight) will be displayed, and you will be returned to Step 3.

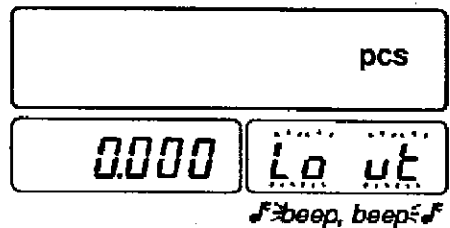

5

- ▣ You may now begin counting operations for pieces of the same weight.
- ▣ Please see **APPENDIX C** for information concerning the **ACAI** counting accuracy function.

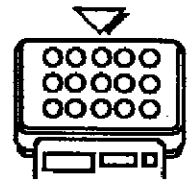



Unit Weight By ID. Number

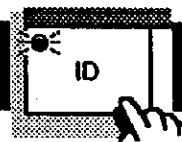

1

○ If there are no Unit Weight's stored into memory, see STORE UNIT WEIGHT BY ID NUMBER on page 4-2.

▶ The three **UNIT WEIGHT BY** LED's should be blinking at this point, if not, press the **RESET** key to clear any Unit Weight.

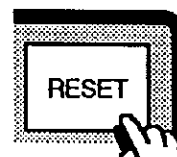

2

▶ Press the **ID** key.

○ 'id000' will appear in the DATA ENTRY display with the blinking.

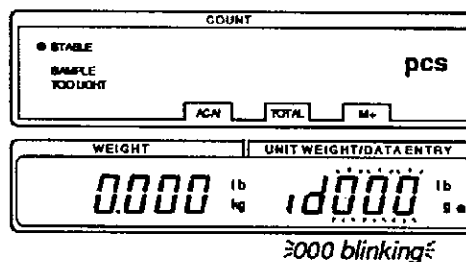
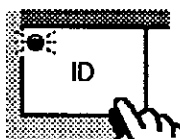

3

▶ Use the **0**→**9** key pad to display the ID number.

⚠ If you hit the wrong key, press the **C** key to clear and start again.

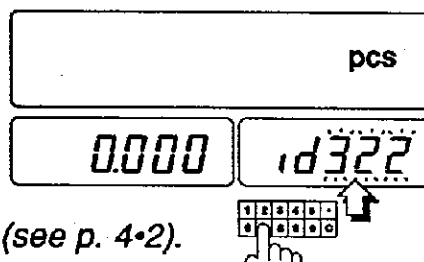
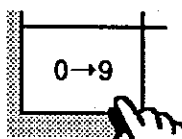

○ For example, let's select ID number '322' (see p. 4-2).

4

▶ Press the **ENTER** key.

○ The COUNT display will show '0' and the scale will recall '12g' previously entered as the Unit Weight of ID 322.

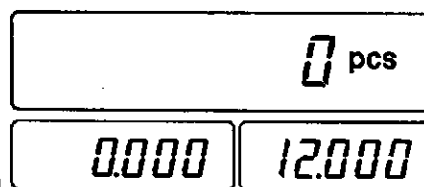
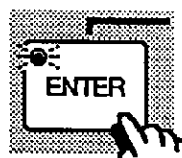

⚠ If there is no Unit Weight entered for the ID number you tried to recall, "no id" will be displayed at this point, and you will be returned to Step 3.

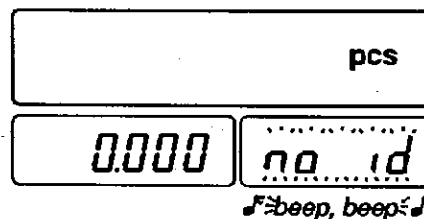

- "id 000" is a special memory area. It always holds the last Unit Weight entered.
- When you register a Unit Weight it is automatically placed in the "id 000" ID.
- If you clear the Unit Weight by pressing the **RESET** key, it can be recalled by recalling the "id 000" ID.

5

▶ You may now begin counting operations for pieces of the Unit Weight entered.

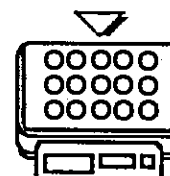



FC Counting Scales

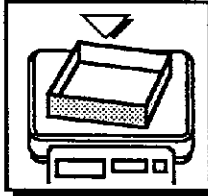

Using TARE *such as a container*



Entering a TARE weight

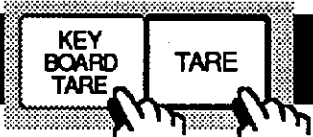

The scale has two methods of TARE operation. One is to subtract the displayed container weight directly by pressing the **TARE** key. Or, digitally enter a TARE weight via the 10-key pad.

Using the TARE Key (Direct Subtraction)



1

- ▶ Remove everything from the weighing pan.

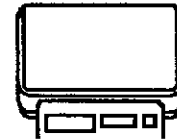

2

- ▶ Press the **ZERO** key.
- The scale will zero and the CENTER OF ZERO indicator will light.

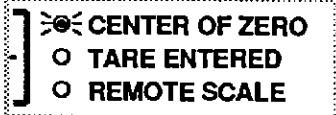
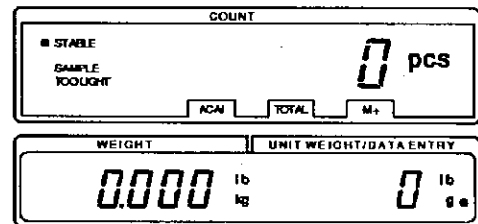

⚠ If WEIGHT ↑ display will not zero, see Appendix A.

3

- ▶ Place TARE container on the weighing pan.
- The WEIGHT display will show the weight of the container.

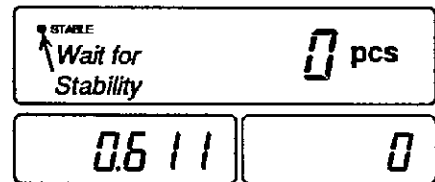

▲ Container Weight

4

- ▶ Press the **TARE** key to subtract the weight of the container.
- The WEIGHT display changes to NET weight.
- The TARE ENTERED indicator will light.

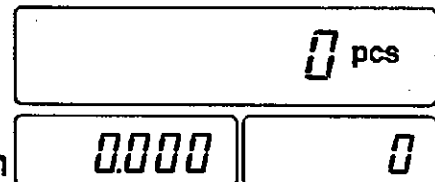

▲ Container weight is subtracted - The display is now in NET mode.



- ⚠ If the scale can not stabilize, then it will not be able to subtract the TARE container's weight. It will stay dashed until stability is reached.

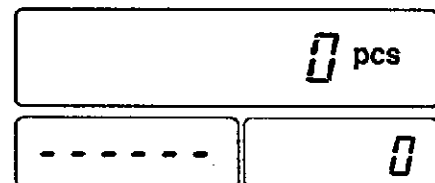

5

- ▶ To clear the TARE weight, see page 3-4.
- ▶ Continue operation. **✓**

Using the KEYBOARD TARE Key

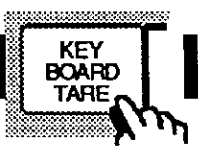

- 1**
- ▶ Press the **KEYBOARD TARE** key.
 - The WEIGHT display will blink along with the **ENTER** key LED (display is any TARE weight previously entered).

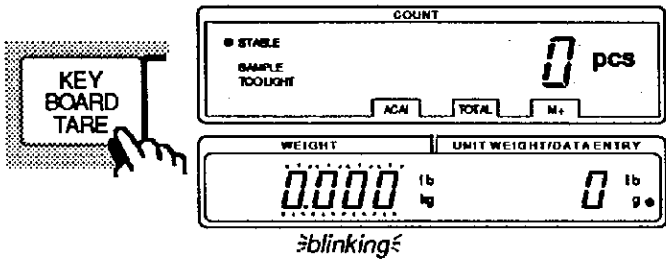

- 2**
- ▶ Use the **0**→**9** & **.** keys to display the the desired TARE weight.
 - ⚠ If you hit the wrong key, press the **C** key to clear and start again.

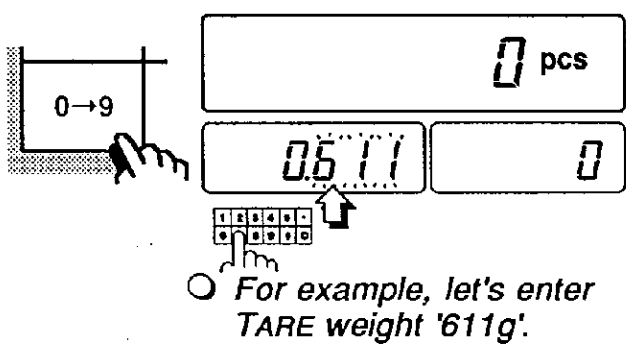

- 3**
- ▶ Press the **ENTER** key.
 - The WEIGHT display changes to NET weight (weight, minus the TARE weight entered).
 - The TARE ENTERED indicator will light.

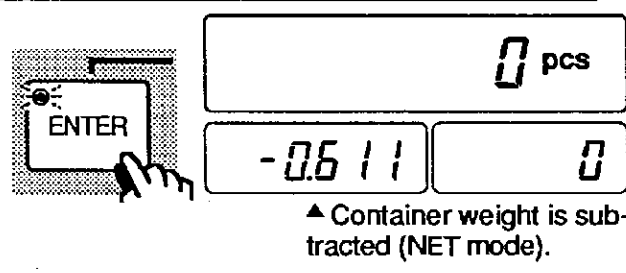

- Ex**
- ▶ Place a TARE container of the weight entered above, on the weighing pan.
 - The WEIGHT display will show '0' ('0' = [-TARE weight entered above] + [actual container weight]).
 - When counting, the WEIGHT display will show the weight of the count pieces, without the TARE container weight.

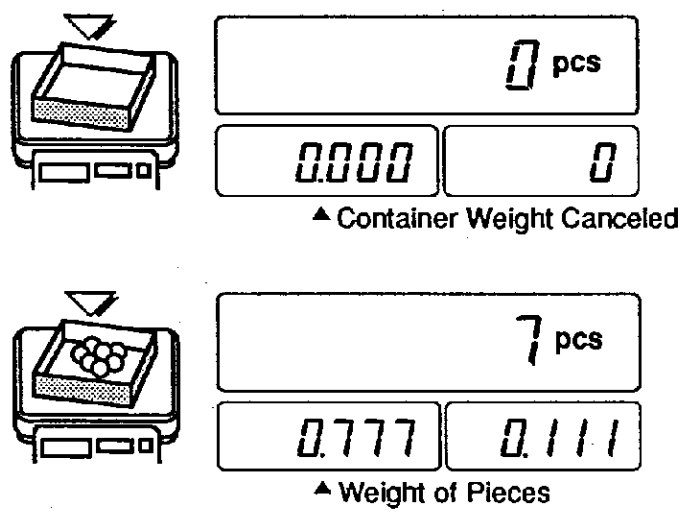

- 4**
- To clear the TARE weight, see page 3•4.
 - ▶ Continue operation. **TV**

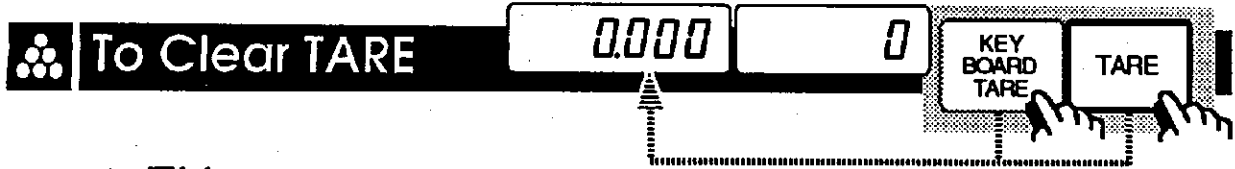

❖ Either:

- 1**
- Have nothing on the weighing pan.
 - If the CENTER OF ZERO indicator isn't ON, press the **ZERO** key to zero the scale.

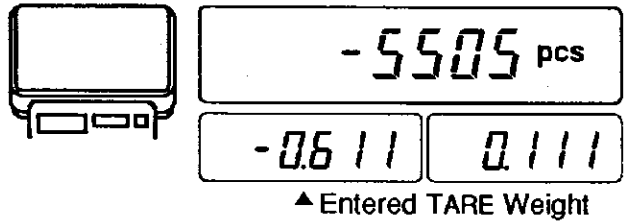

- 2**
- Press the **TARE** key.
 - The WEIGHT display will go to '0'.
 - The TARE ENTERED indicator will go OFF.

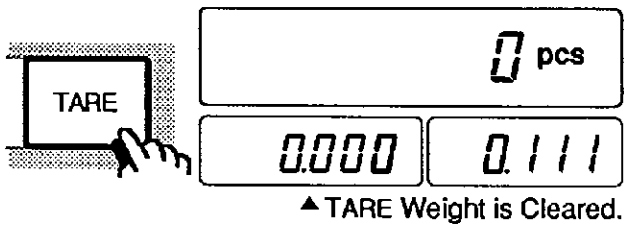

❖ Or:

- 1**
- Press the **KEYBOARD TARE** key.
 - The WEIGHT display will blink along with the **ENTER** key LED (display is any TARE weight previously entered).

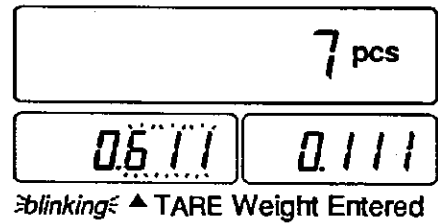
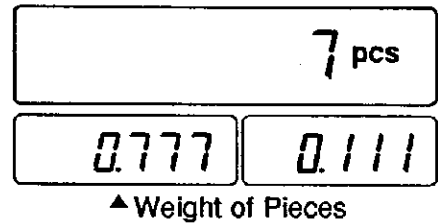
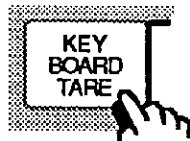

- 2**
- Press the **0** key.
 - Press the **ENTER** key.
 - The WEIGHT display will show the GROSS weight.
 - GROSS = total weight = [container (TARE) weight] + [pieces weight].
 - The TARE ENTERED indicator will go OFF.

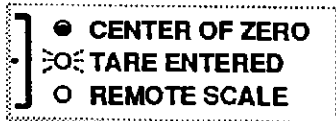
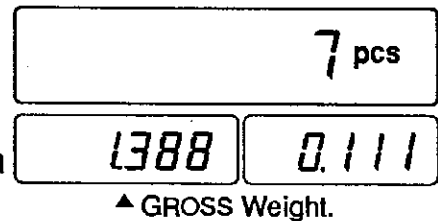
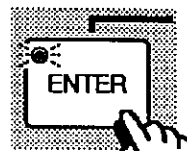
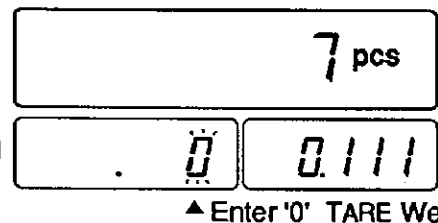
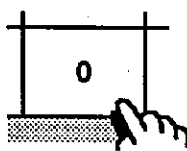



FC Counting Scales

id322

Store Unit Weight

By ID Numbers



Store Unit Weight by ID Numbers

STORE UNIT WEIGHT



The scale can memorize up to 300 Unit Weights by three digit ID numbers, from 001 to 999. To recall, see the UNIT WEIGHT BY ID. NUMBER section on page 2-7. The scale can also remember a TARE weight if desired.

- ▶ The scale is initially set to memorize ID numbers with a unit weight ONLY. However, it can be set to memorize a TARE weight also by setting F-Function F-1-5 at "1", see page 7-8.

1

- ▶ First register a Unit Weight by any method - using a sample or via the 10-key pad - and have it displayed.

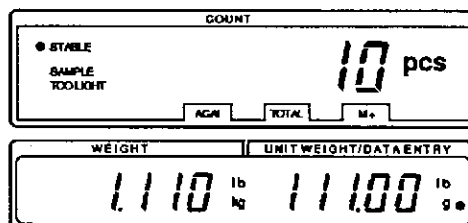

2

- ▶ Press the **STORE UNIT WEIGHT** key.
- 'id000' will appear in the DATA ENTRY display with the '000' blinking.

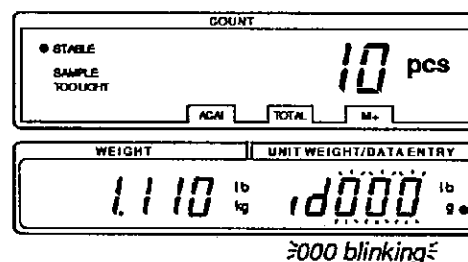

3

- ▶ Use the **0** → **9** key pad to display the new ID number. For example, let's enter ID number '322'.

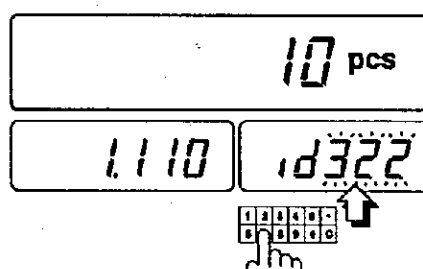
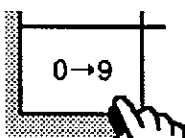

- ⚠ If you hit the wrong key, press the **C** key to clear and start again.

4

- ▶ Press the **ENTER** key, and the ID number will be memorized.
- Display will return to normal.

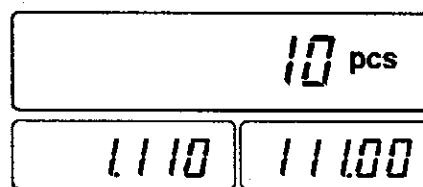
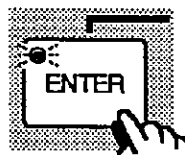

- ⚠ If the same ID number was previously memorized, the scale will beep and the display will hold.

- ▶ You must then select on of two options: either a) Overwrite the old ID Unit Weight, or b) Select a different ID number:

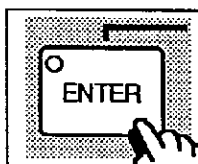
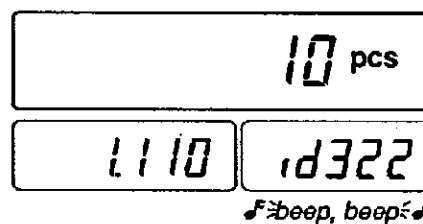

a) Press the **ENTER** key to overwrite the old ID number

OR

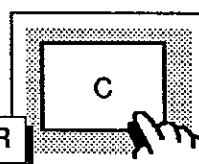

b) Press the **C** key to clear and go to Step 3.



Clearing A Memorized Unit Weight

1

- ▶ Press and hold the **C** key, then press the **STORE UNIT WEIGHT** key - release both.

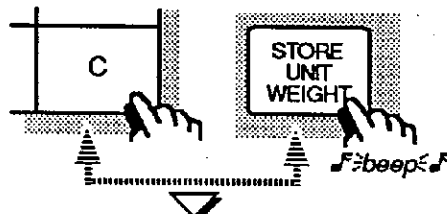

- 'CLEAR' will appear in the WEIGHT display and 'id000' will appear in the DATA ENTRY display with the 000 blinking.

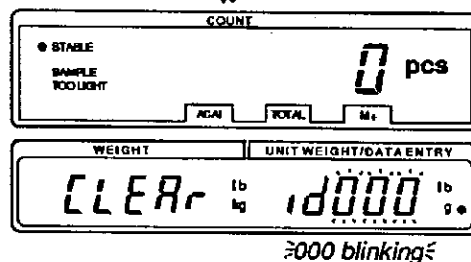

2

- ▶ Use the **0**→**9** key pad to display the ID number to clear. For example, let's clear ID number '322'.

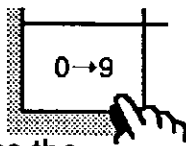

- ⚠ If you hit the wrong key, press the **C** key to clear and start again.

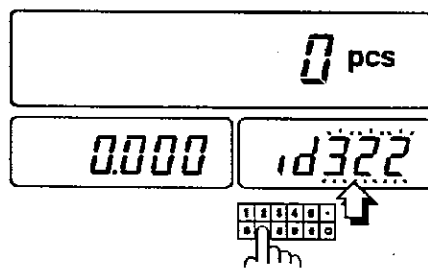

3

- ▶ Press the **ENTER** key, and the ID number will be cleared.

- Display will return to normal. **TV**

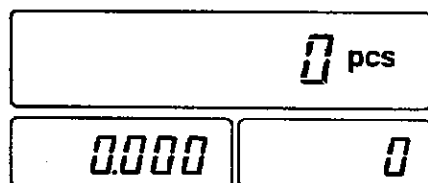
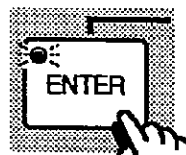

- ⚠ If there is no such ID number to clear, the scale will beep and 'CLEAR' 'id000' will re-appear.

- Returned to Step 2 to try again, or press the **RESET** key to exit.

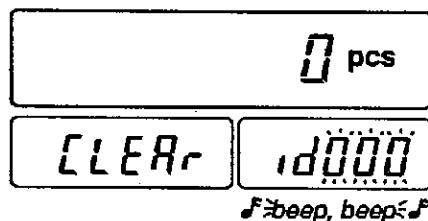



Unit Weight & Tare Memorized



The scale is initially set to memorize ID numbers with a unit weight ONLY. However, it can be set to memorize a TARE weight also by setting F-Function F-1-5 at "1", see page 7-8.

1

- ▶ First register a Unit Weight by any method AND register a TARE Weight by any method.

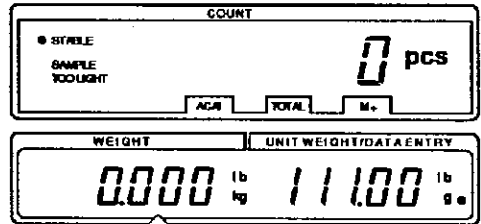

TARE Weight and pcs display will be zero if the tared container is on the weighing pan.

2

- ▶ Go to Step 2, STORE UNIT WEIGHT BY ID NUMBERS section, page 2-7.
- ⚠ When you recall a unit weight by the **ID** key, the TARE weight will also be recalled along with the unit weight (You may also clear the TARE weight then if it is not needed, or if you wish to register a different TARE weight). **17**



"id 000", the special memory area, does not memorize a TARE weight along with unit weight (see page 1-10 if you are unfamiliar with "id000").

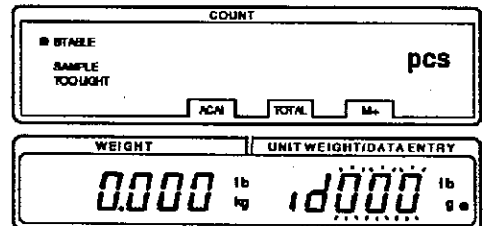



FC Counting Scales

 <p>store 10, +2 = 12 +3 = 15</p>	<h2>Using the M+ Memory</h2>
--	----------------------------------

The M+ Memory Function

TOTAL M+



- ❑ The scale can accumulate count data by pressing the **M+** key, or automatically (see the next page) every time you count. It also keeps track of the number of times you add to the total, these are called 'additions'.
- ❑ When you view the TOTAL by pressing the **TOTAL** key, you view the number of pieces accumulated and the number of additions (how many times the TOTAL was added to). Please see the next two pages for instructions to view or clear the TOTAL count.

Manual Mode

Adding using the M+ Key

1

- ❑ When stable count data is displayed:
- ▶ Press the **M+** key.
- The ▼**M+** annunciator will blink for a few seconds, and there will be a beep to tell you that the scale has added the count.
- ⚠ If there was no beep, or the ▼**M+** annunciator did not blink, then see the note below.

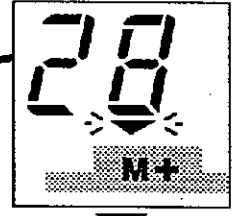
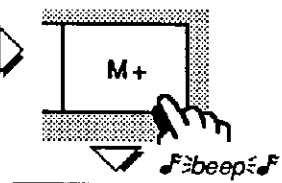
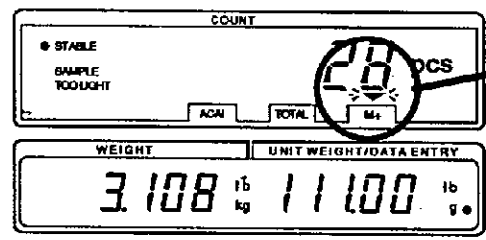
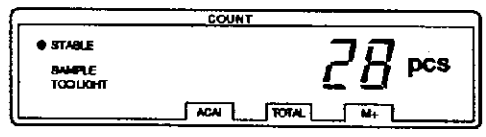

⚠ The ▼**M+** annunciator will stay ON while there is count in memory →

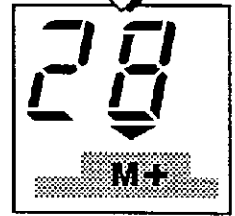

2

- ▶ Press the **M+** key every time you want to add to the count. Remember that you may only add the count data *once* – the scale must return to near zero before it will let you add again.



- ❑ The **M+** key is accepted only *once* for every stable count data. Once accepted, the **M+** key is prohibited until the display returns to within +0.05% of capacity. If there is no beep, check F-Function F-4-4 to see if beeper is ON (p. 7-11).
- ❑ If F-3-2 is set at "1", then the **M+** key can accumulate negative count data. Once the **M+** key is accepted, weight data must return within ±0.05% of capacity before the next accumulation.



FC Counting Scales

 <p>A traffic light icon with three circular lenses. To the right of the top lens is the text "Hi", to the right of the middle lens is "Go", and to the right of the bottom lens is "Lo".</p>	<h2>Comparator Function</h2>
--	----------------------------------



Comparator Function



The scale contains a comparator function that checks the amount on the weighing pan against set acceptable count or weight levels. When the comparator function is activated, "Hi", "Go" or "Lo" is displayed on the UNIT WEIGHT display.

- For example - here the comparator Lower Limit is 9 pcs, Upper Limit is 11 pcs and the beeper is set ON at GO. So, at 10 pcs, "Go" is displayed and the beeper comes ON.

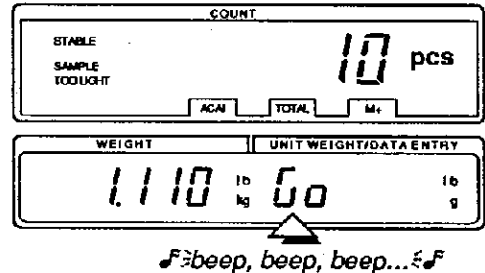

- ▶ Before the comparator will work, Upper and Lower Limits must be set (see below). The levels are set by count, or by weight. So, if you are using weight for your comparator levels, calculate the weight before starting the procedure below.
- ▶ Please see F-Function F-5-X ●COMPARATOR section on page 7•12 for a settings listing.
- If the OP-03 Serial Interface is installed, comparator relay output is also available.
- The comparator responds as follows:
 - "Hi" Upper Limit < Count/Weight Data
 - "Go" Lower Limit ≤ Count/Weight Data ≤ Upper Limit
 - "Lo" Count/Weight Data < Lower Limit



To Set the Comparator

1

- Start with the scale in Standby mode, display OFF.

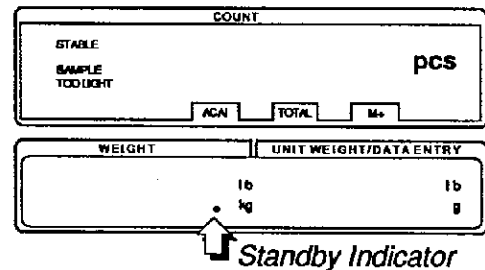

2

- ▶ Press and hold the **ZERO** key, then press the **STANDBY OPERATE** key - release both.
- The pcs display will show "F-0" with the blinking.

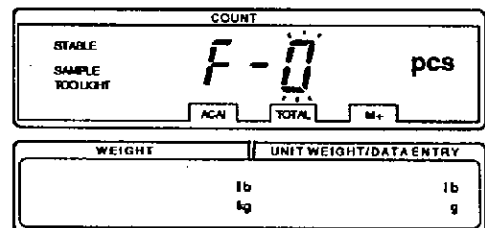
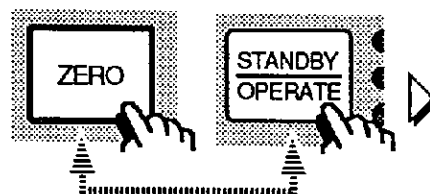

3

- ▶ Press the **5** key to enter into the F-Function **F-5-X** ● **COMPARATOR** section.

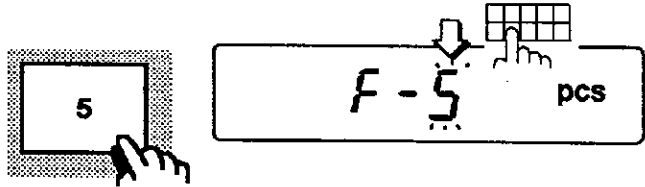

4

- ▶ Press the **ENTER** key.
- The **pcs** display will show "F-5-1" and the blinking UNIT WEIGHT display shows the present setting.

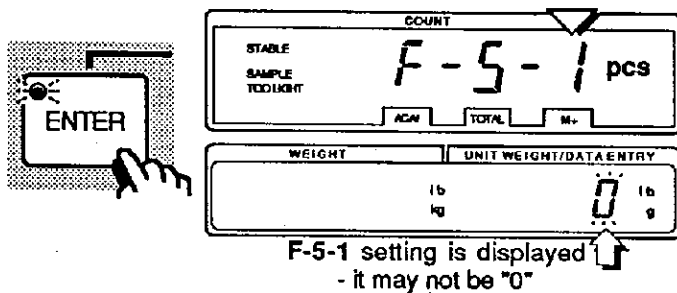

F-5-1 setting is displayed
- it may not be "0"

5

- ▶ Use the **0** → **4** keys to display the number of the desired setting (below).
- For example, let's select **1** COMPARE ALL DATA:

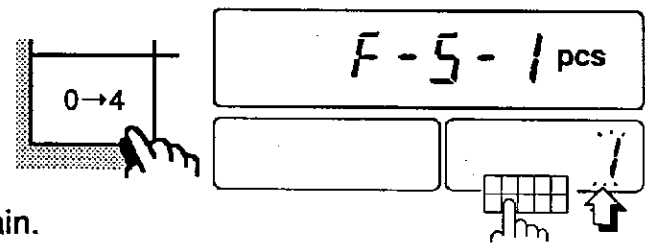

- ⚠ **C** key clears entry to try again.

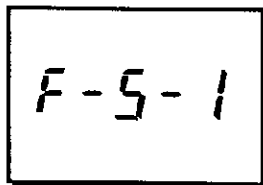

☐ Comparator Mode.	
0	Comparator OFF.
1	Compare all data.
2	Compare stable data.
3	Compare all data except when near ZERO*
4	Compare stable data except when near ZERO*

0 key
1 key
2 key
3 key
4 key

*near ZERO means within ±0.05% of scale capacity.



- ⚠ If you make a mistake and want to escape without saving any changes made *after the last time the ENTER key was pressed* – press the **STANDBY OPERATE** key to exit. After the **ENTER** key is pressed the data is entered.

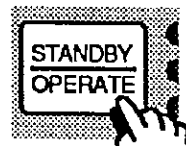

To EXIT

6

- ▶ Press the **ENTER** key.
- The **pcs** display will show the next F-Function, "F-5-2" and the blinking UNIT WEIGHT display shows its present setting.

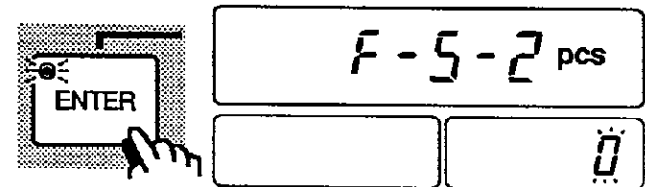

7

- ▶ Continue to enter F-5 comparator settings – see p. 7-12 for a listing. If there are no changes to a F-Function, press the **ENTER** key to move to the next.

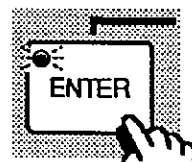

To ENTER
or
MOVE to next

8

- ▶ When finished: press the **STANDBY OPERATE** key to exit. Then, press it again to turn the display back ON. Comparator functions will now operate as set.

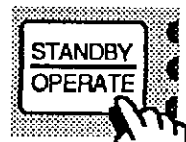



FC Counting Scales

F-5-1

**F-Function
Parameters**



F-Function Parameters



The FC scale has a number of software parameters that enable you to select the best weighing features for your needs. These settings control, for example, the comparator, and how the scale responds to various operations and options. F-Functions are listed on page 7-4 and can be set using the method as shown in the diagram CHANGING F-FUNCTIONS, page 7-6 or as shown below. The individual settings for each group are detailed in the following section THE F-FUNCTIONS, page 7-7.



To Change or View F-Function Settings

1

- Start with the scale in Standby mode, display OFF.

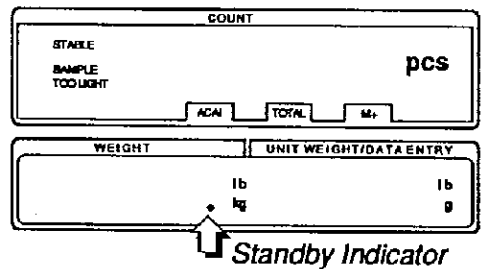

2

- ▣ Press and hold the **ZERO** key, then press the **STANDBY OPERATE** key - release both.
- The pcs display will show "F-0" with the **0** blinking.

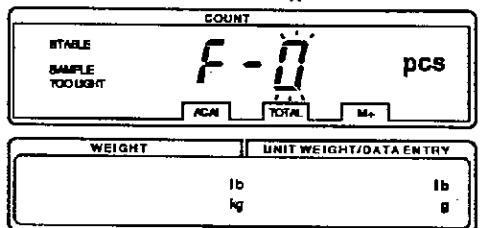
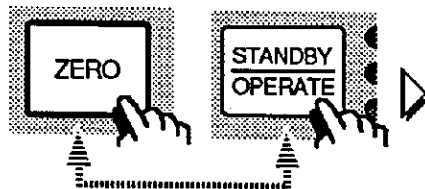

3

- ▣ Press the **0** → **8** keys to display the number of the F-Function section.
- ▣ For example: the **5** key to enter into the F-Function **F-5-X** ● **COMPARATOR** section (see page 7-12).

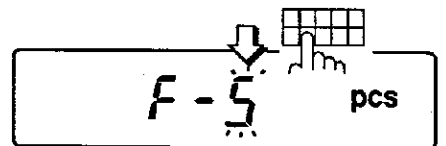
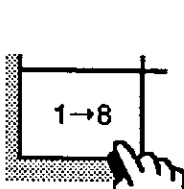

4

- ▣ Press the **ENTER** key.
- The pcs display will show the F-Function and the blinking UNIT WEIGHT display shows its' present setting.

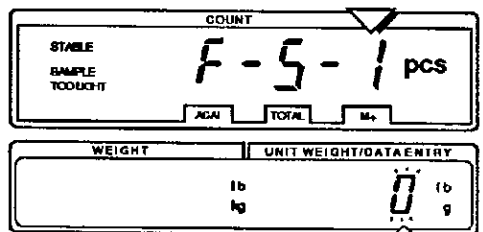
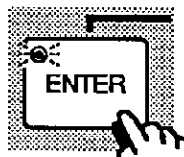

F-5-1 setting is displayed
- it may not be "0"

5

- ▶ You may now either change the setting (Step 6) or move to the next F-Function (Step 7).

6

- ▶ Use the **[0]** → **[9]** keys to change the setting in the DATA ENTRY display.

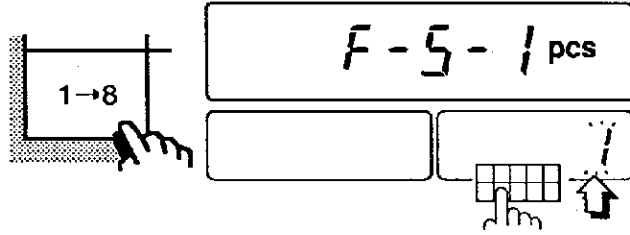

- ⚠ The **[C]** key clears the DATA ENTRY display if you press the wrong 10-key and want to re-enter.

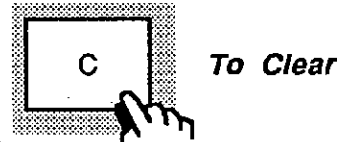

- ⚠ If you make a mistake and want to escape without saving any changes made *after the last time the [ENTER] key was pressed* – press the **[STANDBY OPERATE]** key to exit.

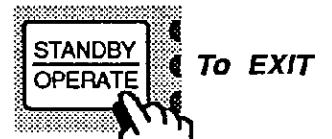

- ⚠ After the **[ENTER]** key is pressed the data is entered.

7

- ▶ Press the **[ENTER]** key to save any changes AND/OR move to the next.
- The **pcs** display will show the next F-Function, and the blinking UNIT WEIGHT display shows its present setting.

To ENTER
or
MOVE to next

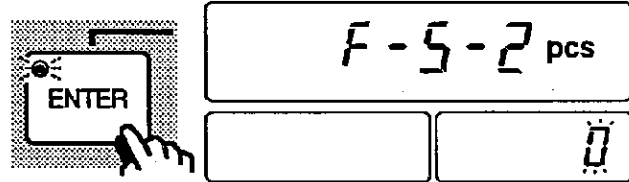

8

- ▶ When finished: press the **[STANDBY OPERATE]** key to exit. Then, press it again to turn the display back ON. Comparator functions will now operate as set. **[TV]**

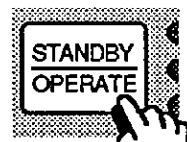



F-Function Overview

The FC series scale has various software parameters that enable you to select the weighing features for your needs. These settings control how the scale will receive and respond to various operations, including data output, calibration and peripherals. They can be changed as directed in the previous section TO CHANGE OR VIEW F-FUNCTION SETTINGS, page 2-2 or the diagram CHANGING F-FUNCTIONS, page 7-6. The individual settings for each group are detailed in the following section THE F-FUNCTIONS, page 7-7.

<input checked="" type="checkbox"/> F-1-X • Operations		
<input type="checkbox"/> F-1-1 X	Operation Mode	p. 7-7
<input type="checkbox"/> F-1-2 X	"Add" Sample Request Override	p. 7-7
<input type="checkbox"/> F-1-3 X	Auto  after Unit Weight Registration	p. 7-7
<input type="checkbox"/> F-1-4 X	Display ON Unit Weight - RESET or Last	p. 7-8
<input type="checkbox"/> F-1-5 X	ID Memory Contents	p. 7-8
<input type="checkbox"/> F-1-6 X	Unit Weight With a 2 Scale System	p. 7-8

<input checked="" type="checkbox"/> F-2-X • ACAI Operation & Minimum Unit Weight		
<input type="checkbox"/> F-2-1 X	ACAI - Unit Weight is by Sample Pieces	p. 7-9
<input type="checkbox"/> F-2-2 X	ACAI - Unit Weight is by ID or Digital Input	p. 7-9
<input type="checkbox"/> F-2-3 X	Minimum Unit Weight	p. 7-9

<input checked="" type="checkbox"/> F-3-X • M+ Accumulation Function		
<input type="checkbox"/> F-3-1 X	M+ Accumulation – Automatic or Manual	p. 7-10
<input type="checkbox"/> F-3-2 X	+ or – Count Data Acceptable	p. 7-10

<input checked="" type="checkbox"/> F-4-X • Environment and Beeper		
<input type="checkbox"/> F-4-1 X	Zero Tracking	p. 7-11
<input type="checkbox"/> F-4-2 X	Averaging Time	p. 7-11
<input type="checkbox"/> F-4-3 X	Stable Detection Speed / Environment	p. 7-11
<input type="checkbox"/> F-4-4 X	Beeper	p. 7-11

<input checked="" type="checkbox"/> F-5-X • Comparator		
<input type="checkbox"/> F-5-1 X	Comparator Mode	p. 7-12
<input type="checkbox"/> F-5-2 X	Data to Compare – Count or Weight	p. 7-12
<input type="checkbox"/> F-5-3 X	Upper Limit	p. 7-12
<input type="checkbox"/> F-5-4 X	Lower Limit	p. 7-12
<input type="checkbox"/> F-5-5 X	A Beep with Comparator Results	p. 7-12

▶ F-6-X • Data Output (Requires Option OP-03)		
<input type="checkbox"/> F-6-1 X	Data Out Mode	p. 7-13
<input type="checkbox"/> F-6-2 X	Data to be Send	p. 7-13
<input type="checkbox"/> F-6-3 X	Data Format	p. 7-13
<input type="checkbox"/> F-6-4 X	Baud Rate	p. 7-13

▶ F-7-X • External Control Signal Input (Requires Option OP-03)		
<input type="checkbox"/> F-7-1 X	Control Signal Input #1	p. 7-14
<input type="checkbox"/> F-7-2 X	Control Signal Input #2	p. 7-14
<input type="checkbox"/> F-7-3 X	Control Signal Input #3	p. 7-14
<input type="checkbox"/> F-7-4 X	Control Signal Input #4	p. 7-14
<input type="checkbox"/> F-7-5 X	Control Signal Input #5	p. 7-14

▶ F-8-X • Weighing Unit (USA only)		
<input type="checkbox"/> F-8-1 X	Weight Display	p. 7-14
<input type="checkbox"/> F-8-2 X	Unit Weight (when "lb" is selected)	p. 7-14

Changing F-Functions

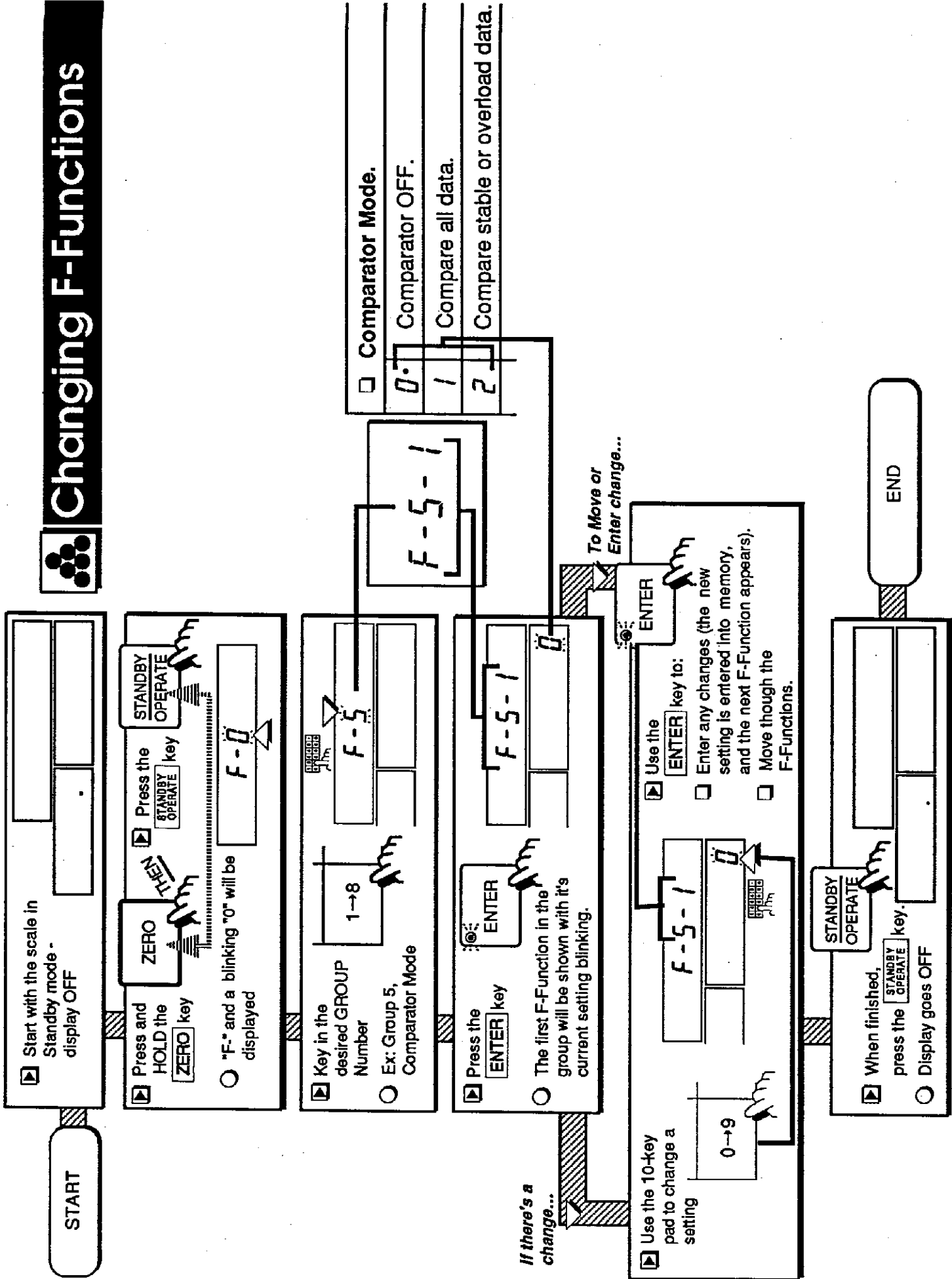



F-Functions



F-1-X ● Operations



F-1-1

<input type="checkbox"/> Operation Mode.	
0 <	Normal Operation. All features and keys available.
/	Simplified Operation. Unit Weight registration is by sample ONLY. All other keys are disabled.

F-1-2

<input type="checkbox"/> "Add" Sample Request Override. If the sample weight is too light and the scale asks to "Add" more sample pieces, using this F-Function, the Unit Weight can be entered (via the ENTER key) without adding the requested sample pieces.	
0 <	Unit Weight <u>can be entered</u> without requested "Add" sample pieces (via the ENTER key).
/	Unit Weight <u>cannot be entered</u> without the requested "Add" sample pieces.

F-1-3

<input type="checkbox"/> Auto  after Unit Weight Registration. The scale can be set to switch to the remote scale after Unit Weight Registration, instead of having to manually press the  key. Please note that this does not affect any other use of the  key (also see 'F-1-6').	
0 <	No automatic switching.
/	Automatic switch to the remote scale after FC scale Unit Weight Registration.

 F-1-3 requires OP-05 and a remote scale

F-1-4

<p><input type="checkbox"/> Display ON Unit Weight - RESET or Last. When the display is turned ON, the scale can be set to recall the last Unit Weight used. •Please note that if power is interrupted (such as the AC adaptor removed), then the last Unit Weight cannot be recalled. •Remember that you can recall the last Unit Weight used even when the scale has been RESET by using the ID key to recall "id 000" (see p. 1•10).</p>	
□ ◀	Unit Weight is RESET (cleared) when display comes ON.
/	Unit Weight last used (before display OFF, not power interrupt) will be entered automatically.

F-1-5

<p><input type="checkbox"/> ID Memory Contents. The scale ID memory can contain Unit Weights with TARE weights (such as the weight of a container) or just Unit Weights alone.</p>	
□ ◀	ID memory contains Unit Weight ONLY.
/	ID memory contains Unit Weight and can contain TARE weights (if entered).

F-1-6

 F-1-6 requires OP-05 and a remote scale

<p><input type="checkbox"/> Unit Weight with a 2 scale system. When operating a 2 scale system, the remote scale may have an independent Unit Weight, or restricted to the same as the main scale. ▶ The factory setting for the USA is '1-6-1', for all others it is '1-6-0'.</p>	
□	Each scale can have it's own Unit Weight. Please see page 12•3.
/	Main and Remote scales have the same Unit Weight ONLY.

F-2-X ● ACAI Operation & Min. Unit Weight

F-2-1	<input type="checkbox"/> ACAI Mode When Unit Weight entered by <i>Sample Pieces</i>.	
	0	ACAI Automatic Operation.
	1	ACAI Manual Mode (using the ENTER key).

F-2-2	<input type="checkbox"/> ACAI Mode When Unit Weight entered by <i>ID or Digital Input</i>.	
	0	ACAI Manual Mode (using the ENTER key).
	1	ACAI Automatic obeys F-2-1 setting.

F-2-3	<input type="checkbox"/> Minimum Unit Weight. (For Models other than FC-31K)	
	0	0.002% of capacity.
	1	0.0002% of capacity.
	<input type="checkbox"/> Minimum Unit Weight. (For Model FC-31K)	
	0	0.5g of capacity (0.001 lb).
	1	0.1g of capacity (0.0002 lb).

F-3-X ● M+ Accumulation Function

F-3-1

<input type="checkbox"/> M+ Accumulation – Automatic or Manual.	
0 •	Manual accumulation (by pressing the M+ key).
1	Automatic accumulation (Positive data ONLY). • Count data is added to the M+ memory total (as well as adding one to the event count) once, then the scale must return to zero (within 0.05% of capacity) before the next count can be accumulated.

F-3-2

<input type="checkbox"/> + or – Count Data Acceptable. (Manual Accumulation)	
0 •	Positive data ONLY (above 0.05% of capacity).
1	Positive and negative data (above or below 0.05% of capacity).

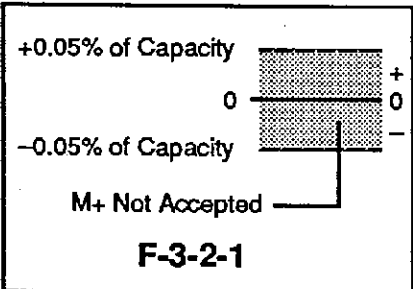
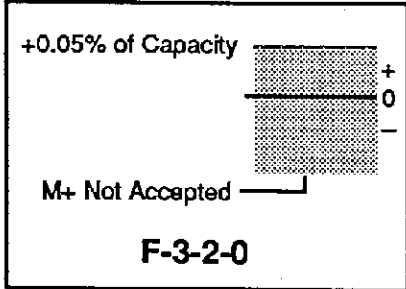



F-4-X ● Environment and Beeper

F-4-1

Zero Tracking.

ZERO Tracking traces a drift from ZERO caused by the change of temperature, humidity, air pressure, etc., and stabilizes the ZERO point.

0 • Zero Tracking ON.

1 Zero Tracking OFF.

F-4-2

Averaging Time.

3 • 3 seconds.

1~6 1 to 6 seconds selectable.

F-4-3

Stable Detection Speed / Environment.

0 Fast Stable Detection (good environment).

1 • Normal.

2 Slow Stable Detection (poor environment).

F-4-4

Beeper.

This is not the the beeper for the comparator, it is the beeper tone that is heard at other times.

0 • Beeper Tone ON.

1 Beeper Tone OFF.

F-5-X ● Comparator

F-5-1

<input type="checkbox"/> Comparator Mode.	
0	Comparator OFF.
1	Compare all data.
2	Compare stable data.
3	Compare all data except when near ZERO*
4	Compare stable data except when near ZERO*
* 'near ZERO' means within $\pm 0.05\%$ of scale capacity.	

F-5-2

<input type="checkbox"/> Data to Compare – Count or Weight.	
0	Compare count data.
1	Compare weight data.

F-5-3

<input type="checkbox"/> Upper Limit.	
0	Enter via the 10-key pad 

- The comparator responds as follows:
- "Hi" Upper Limit < Count/Weight Data
 - "Go" Lower Limit \leq Count/Weight Data \leq Upper Limit
 - "Lo" Count/Weight Data < Lower Limit

F-5-4

<input type="checkbox"/> Lower Limit.	
0	Enter via the 10-key pad 

F-5-5

<input type="checkbox"/> A Beep with Comparator Results. These are beeps for the comparator, it is not the beeper tone that is heard at other times.	
000	All Comparator Beepers are OFF.
	0 = Beeper OFF 1 = Beeper ON
Example:	The GO beep is ON - HI & LO are OFF The scale will beep continuously when display meets GO condition.

F-6-X ● Data Output

**F-6 requires
OP-03**
F-6-1

<input type="checkbox"/> Data Out Mode.	
0	Key Mode: Data is sent by pressing the PRINT key.
1	Stream Mode: Data is sent continuously.
2	Auto-Print Mode A: Data is sent if the Weight display is stable, and more than +0.05% of capacity.
3	Auto-Print Mode B: Data is sent if the Weight display is stable, and above/below $\pm 0.05\%$ of capacity.

F-6-2

<input type="checkbox"/> Data to be Send.																			
0 100	Count data sent.																		
<table border="0"> <tr> <td>ID</td> <td>Weight</td> <td></td> </tr> <tr> <td>↓</td> <td>↓</td> <td></td> </tr> <tr> <td>0000</td> <td></td> <td></td> </tr> <tr> <td>↑</td> <td>↑</td> <td></td> </tr> <tr> <td>PCS</td> <td>Unit</td> <td></td> </tr> <tr> <td>(count)</td> <td>Weight</td> <td></td> </tr> </table>	ID	Weight		↓	↓		0000			↑	↑		PCS	Unit		(count)	Weight		<p>You select which data to be sent by keying in a "0" or "1" for the data: ID number, PCS (count), Weight, or Unit Weight.</p> <p>Example: Key in 1 1 0 0 to display 1 100, this setting would send only the ID number and the count (then press the ENTER key).</p>
ID	Weight																		
↓	↓																		
0000																			
↑	↑																		
PCS	Unit																		
(count)	Weight																		

F-6-3

<input type="checkbox"/> Data Format.	
0	AD-8117 format.
1	AD-8117A format.
2	Format for general apparatuses, computers, etc.

F-6-4

<input type="checkbox"/> Baud Rate.	
0	600 bps.
1	1200 bps.
2	2400 bps.
3	4800 bps.
4	9600 bps.



F-7-X ● External Control Signal Input

F-7 requires
OP-03

F-7-1

↓ through

F-7-5

<input type="checkbox"/> Control Signal Input #1→5. Select an input (key function) as listed below for each, or any, F-Functions F-7-1 through F-7-5*.	
0	Reset RESET .
1	Enter ENTER .
2	Tare TARE .
3	Zero ZERO .
4	Sample SAMPLE .
5	Remote Scale REMOTE SCALE .
6	Total TOTAL .
7	M+ M+ .
8	Standby / Operate STANDBY OPERATE .
9	Print PRINT .

***Factory Settings for F-7-1 through F-7-5**

F-7-1	1.	Enter ENTER .
F-7-2	2.	Tare TARE .
F-7-3	3.	Zero ZERO .
F-7-4	4.	Sample SAMPLE .
F-7-5	0.	Reset RESET .



F-8-X ● Weighing Unit

USA Version
ONLY

F-8-1

<input type="checkbox"/> Weight Display.	
0	kg (kilograms).
1	lb (pounds).

F-8-2

<input type="checkbox"/> Unit Weight (when "lb" is selected).	
0	lb as piece weight.
1	lb as 1,000 piece weight.



FC Counting Scales

	<h2>OP-01</h2> <h3>Bar Code Reader</h3>
---	---



About OP-01

- ▶ Included in OP-01 Bar Code Reader is: the Bar Code Reader wand, and a Bar Code Label Set (Bar Codes ID 001→300).
 ⚠ Keep the reader and the bar code labels clean.

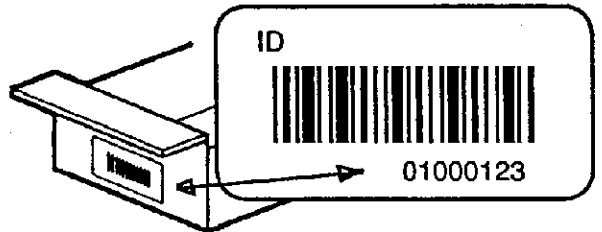

- ▶ Option OP-03, Serial Interface is require to use the OP-01 Bar Code Reader.
- ▶ The Bar Code Reader can recall unit weight (along with a TARE weight) from a Bar Code Label instead of by using the **ID** key. Please see section 4, STORE UNIT WEIGHT BY ID NUMBERS.



Using OP-01

1

Connect the bar code reader wand unit to the OP-03 interface (under the Display Pod, front of the scale).

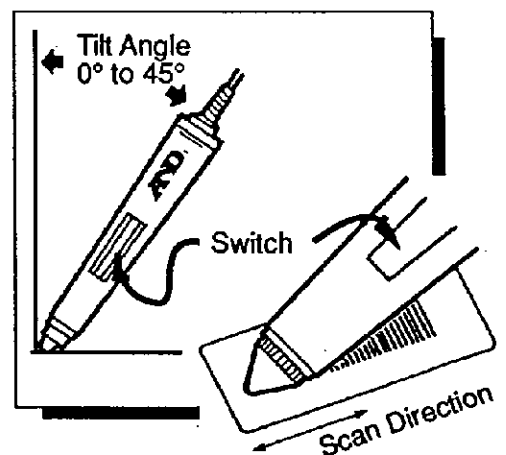
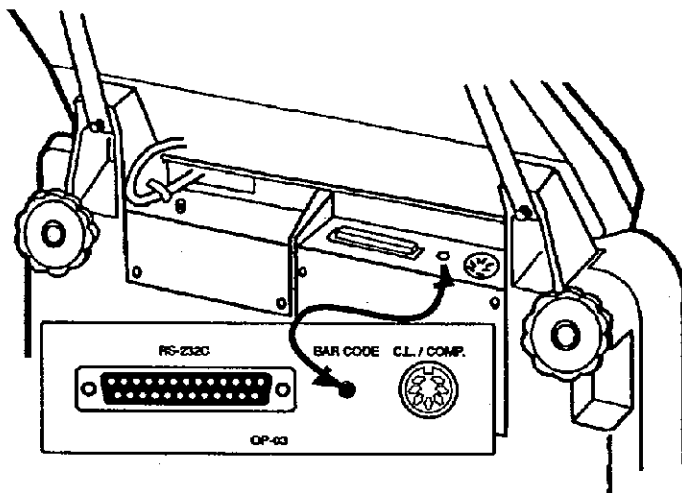

2

- ▶ To read, press and hold the reader's switch while drawing it across the printed bar code label.
 - Keep the reader at a 0° to 45° angle (10° to 30° best), and keep an even speed that's not too slow. The reader's light tip should be in contact with the label, and excessive pressure with not improve the reading rate.
- The scale will recall the unit weight of the ID number stored in memory, then a beep (there's no beep if F-4-4 is set to beeper OFF). ⚠ If the reader does not read the ID number then nothing will happen and there will be no beep.

- ⚠ If there is no Unit Weight entered for the ID number you tried to recall, "no id" will be shown, and the display will return to as it was. **TV**

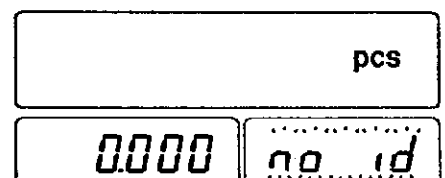



FC Counting Scales

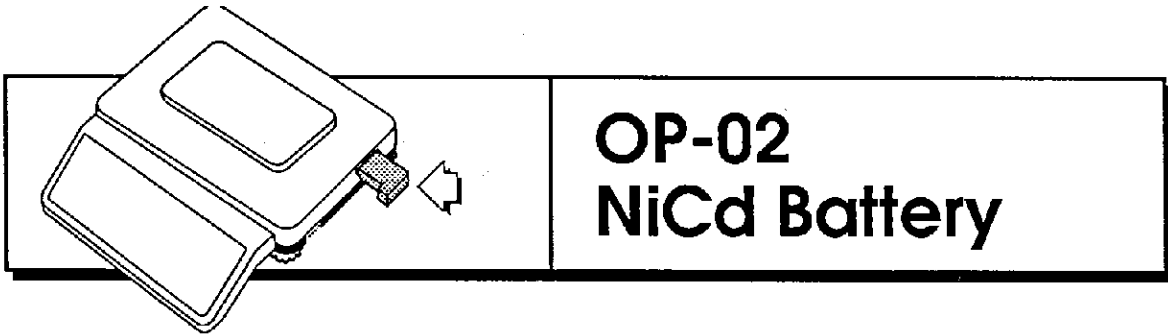



Using OP-02



By using the OP-02 NiCd Battery pack, the scale can be operated for around 10 hours (after a full charge and using no other options which require power, such as OP-03).

1

After making sure that the Battery Switch on the battery pack is OFF – insert the battery pack firmly into the right side of the scale.

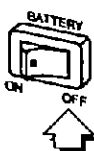

2

Tighten the lock screw on the battery pack.

3

When desired, turn the Battery Switch ON to supply power to the scale. The display will come ON after its self-check.

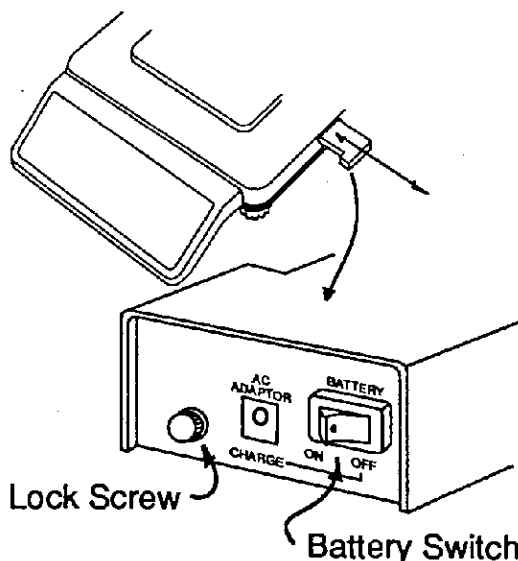

4

Use the **STANDBY OPERATE** key to turn the display ON or OFF. When the scale is in Standby mode, a period appears in the WEIGHT Display as an indicator.

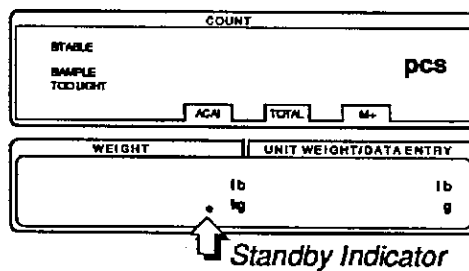
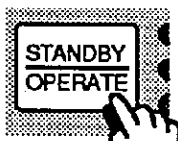

⚠ When the Weight display shows "Lo b" for low battery, the battery power is almost exhausted and should be recharged.

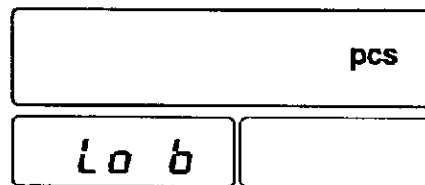

The **STANDBY OPERATE** key only turns the display ON or OFF (and keeps the scale warmed up on standby). When the scale is not used for a long periods, the battery should be switched OFF.

Recharging the Battery



There is basically only one way to charge the battery. Connect the AC adaptor to the battery pack and while it's charging, and do not use the battery pack to run the scale. If you would like to use the scale while charging the battery, we strongly recommend that you purchase a second AC adaptor (contact your A&D dealer) and supply both with power.

1

Turn the Battery Switch on the battery pack OFF.



2

- ▣ Fully loosen the Lock Screw and remove the battery pack.
- If you want to recharge the battery while it is still in the scale, you may do so. In that case, disregard Step 2 - but do not turn the battery switch ON. If you wish to use the scale, connect another AC adaptor to the scale.

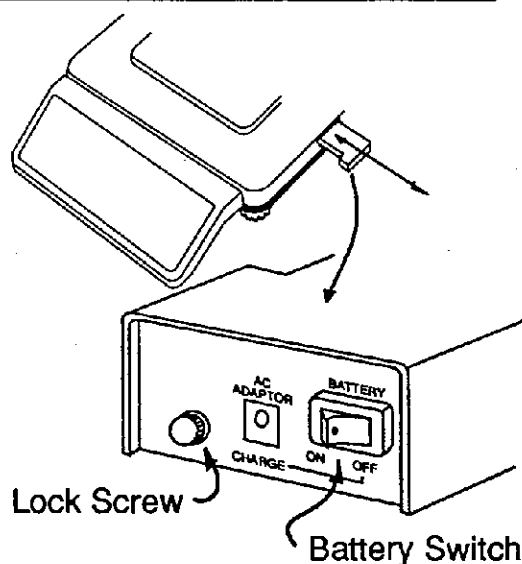

3

Connect the AC adaptor to the battery pack.

- ▣ The battery pack will take about 15 hours to fully charge.

Battery Switch	AC Adaptor to Battery Pack	AC Adaptor to Scale	Charge	Scale Operation
ON or OFF	Connected	Connected	Full Charge	Operational
ON or OFF	Not Connected	Connected	Trickle Charge	Operational
OFF	Connected	Not Connected	Full Charge	Not Operational
OFF	Not Connected	Not Connected	No Charge	Not Operational
ON	Connected	Not Connected	Not Recommended	Not Recommended
ON	Not Connected	Not Connected	Discharge	Battery Operation





FC Counting Scales





OP-03 Includes:



- ▣ Serial RS-232C
- ▣ Serial Current Loop
- ▣ Comparator Relay Output



- ▣ Bar Code Reader Input
- ▣ External Signal Input
- ▣ 7-pin DIN Connector (TCP 0576) as an accessory



Installation

1

Disconnect the AC/DC adaptor from the scale.

2

Remove the three screws and panel covering the RS-232C slot.

3

Insert the OP-03 assembly, making sure that it makes a good connection with the connector in the FC.

4

Replace the three screws and panel covering the RS-232C slot. Connect the AC/DC adaptor from the scale. Earth the chassis if you think static electricity may be a problem.

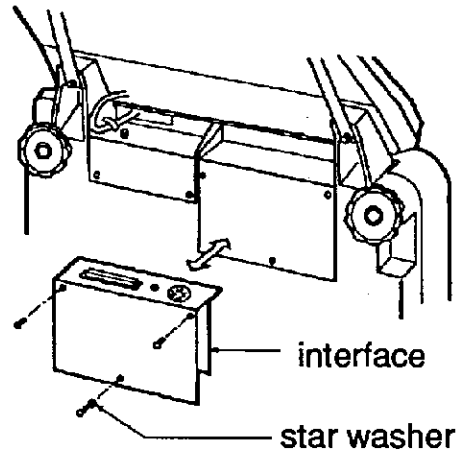

OP-03 Specifications

Type: EIA-RS-232C (bi-directional) / 20mA Current Loop (passive)

Method: Asynchronous Transmission, RS-232C is Bi-directional.

Format: Baud rate: 600, 1200, 2400, 4800 and 9,600 baud. Rates user selectable, see page 7-13, F-6-4.

Data bit: 7.

Stop bit: 2.

Parity: Even.

Code: ASCII.

Terminator: Data Send: LF • Data Receive: or LF

- ▣ The FC is designated as DCE (Data Communication Equipment).
- ▣ The Current Loop is passive. An external power supply is required.
- ▣ The Current Loop transmits the same data as the RS-232C.
- ▣ Please confirm that proper conditions have been met for connecting equipment. Refer to connection equipment's manual.



Comparator Pin Connection

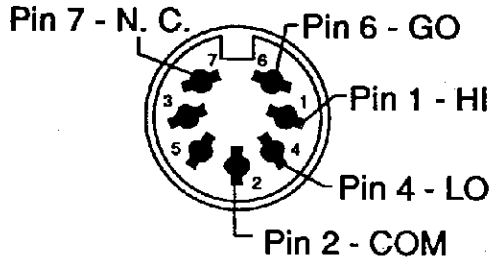

Pin 1 - HI
Pin 2 - COM
Pin 3 - Loop
Pin 4 - LO
Pin 5 - Loop
Pin 6 - GO
Pin 7 - N.C.

Specifications: **Max. Voltage** 50V DC
 Max. Current 200 mA



Current Loop Pin Connection

A 7-pin DIN male Current Loop connector (TCP 0576) is provided for the passive Current Loop interface.

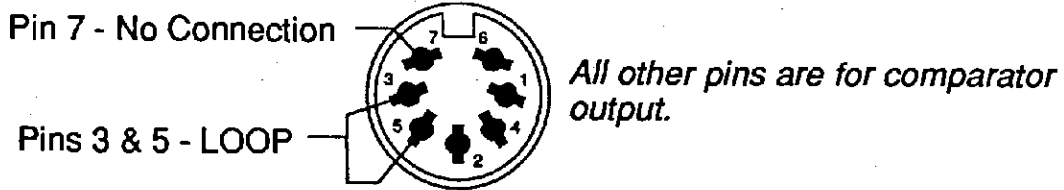

- **AD-8117/A** to connect the scale with the AD-8117/A via the current loop, please order the AD-8117 OP-01 option cable.



Data Output Mode • Printing



The Data Output Modes and Parameters are set by F-Functions in F-6-X as described in the F-FUNCTION PARAMETERS, section 7.

F-6-1

<input type="checkbox"/> Data Out Mode. ⚠ Commands for data output can only occur through the RS-232C from an external device. If using output commands, do not use setting '1'	
0	Key Mode: When the display is stable, data is sent by pressing the PRINT key. The COUNT display will blink when the data has been sent.
1	Stream Mode: Data is sent continuously. • for F-6-3='2', ≈ 1/5 second (except 600 baud) • for F-6-3='0' or '1', 1 line per 0.8 sec. delay. Also, if F-6-2 also = '1111', it's 4 lines per 3.2 s. delay
2	Auto-Print Mode A: Data is sent if the Weight display is stable & more than +0.05% of capacity. Next transmission can not occur until after the WEIGHT display falls below 0.05% of capacity.
3	Auto-Print Mode B: Data is sent if the WEIGHT display is stable, and above/below ±0.05% of capacity. Next transmission can not occur until after the WEIGHT display falls between -0.05% and 0.05% of capacity.

F-6-2

<input type="checkbox"/> Data to be Send.	
0 100	Count data sent.
ID Weight ↓ ↓ 0000 ↑ ↑ PCS Unit (count) Weight	You select which data to be sent by keying in a "0" or "1" for the data: ID number, PCS (count), Weight, or Unit Weight.
Example: Key in 1 1 0 0 to display 1100, this setting would send only the ID number and the count (then press the ENTER key).	

F-6-3

<input type="checkbox"/> Data Format.	
0	AD-8117 format.
1	AD-8117A format.
2	Format for general apparatuses, computers, etc.

F-6-4

<input type="checkbox"/> Baud Rate.	
⚠ If the Data Format, F-6-3 , is set for use with an AD-8117 or AD-8117A, then the baud rate is automatically set at 2400 bps.	
0	600 bps.
1	1200 bps.
2	2400 bps.
3	4800 bps.
4	9600 bps.

Connecting the AD-8117 Printer



When using the AD-8117 printer, you will be able to get data: Total; Mean Value; Maximum, Minimum and Standard Deviation.

Print Operations Settings

Print By:	F-Function F-6-1	Printer MODE Switch
FC PRINT key	0	1
Auto Print	2 or 3	1
Printer PRINT key	1	2

Notes

- 1** To print PSC (count) data only: set F-6-2 at '0 100'
- 2** To print Weight data only: set F-6-2 at '00 10'
- 3** To print PSC (count) and Weight data: set F-6-2 at '0 1 10'
- 4** To print PSC, Weight and Unit Weight data: set F-6-2 at '0 1 1 1'
- 5** To print Total data (accumulated by the **M+** key), press the **TOTAL** key so the pcs display shows the total, then press the **PRINT** key. The total will be sent along with the number of additions to **M+** memory.
- 6** If you are using the AD-8117's statistic functions, then set F-6-2 at '0 100' or '00 10'.
- 7** The AD-8117 can not print ID numbers.

Connecting the AD-8117A Printer



When using the AD-8117A printer, printouts are obtained by the **PRINT** key (F-6-1-0), or **Auto-Print Mode A/B** (F-6-1-2/3).

⚠ The AD-8117A does not have statistical functions.

To Print Internal F-Function Settings

1

- Start with the scale in Standby mode, display OFF.

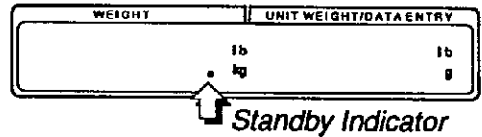

2

- ▶ Press and hold the **ZERO** key, then press the **STANDBY OPERATE** key - release both.

- The pcs display will show "F-0" with the $\geq 0 \leq$ blinking.

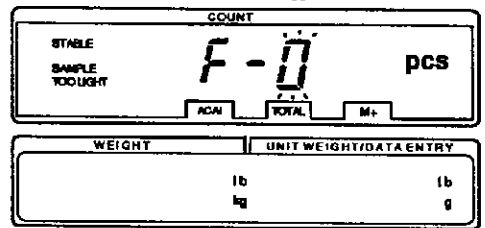
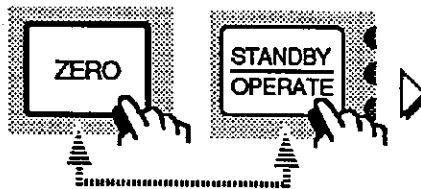

3

- ▶ Press the **9** key to display F-Function group 9.

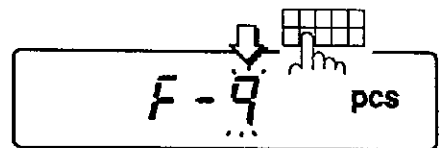
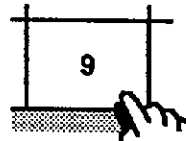

4

- ▶ Press the **ENTER** key.
- The pcs display will show F-9-1 and the UNIT WEIGHT display shows '00'.

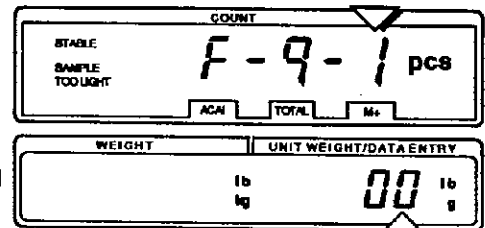
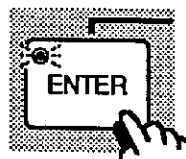

5

- ▶ Press the **1** key.

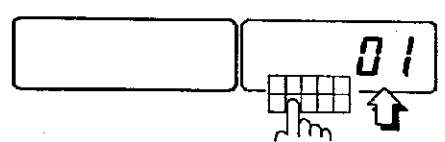
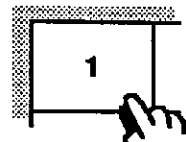

6

- ▶ Press the **ENTER** key.
- The pcs display will show F-9-2 and the WEIGHT display shows 'Print'.
- Printing will begin. When it's finished, the UNIT WEIGHT display returns to '00'.

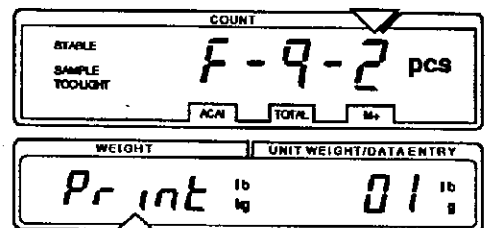
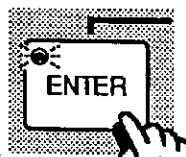

To Print ID Memory Contents



The AD-8117A can print out all of the ID memories stored. If you want:

- ID number and Unit Weight: F-1-5 = '0'
- ID number, Unit Weight and TARE Weight: F-1-5 = '1'

1 → 4

Follow Steps 1→4 on the previous page, TO PRINT INTERNAL F-FUNCTION SETTINGS, and continue with Step 5 below.

5

Press the **2** key.

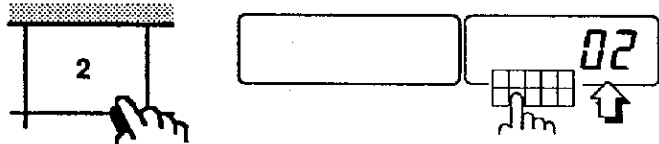

6

Press the **ENTER** key.

- The pcs display will show F-9-2 and the WEIGHT display shows 'Print'.

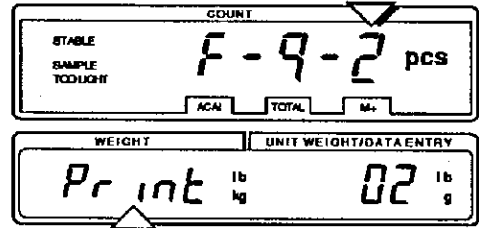

- Printing will begin. When it's finished, the UNIT WEIGHT display returns to '00'.

Printout Sample

AD-8117

AD-8117A

PCS (Count)	QT	+897	PC
Weight	WT	+2.032	kg
Unit Weight	UW	+2.3129	g
		*	
	QT	+915	PC
	WT	+2.116	kg
	UW	+2.3129	g
		*	
TOTAL	AQ	+1794	PC

ID Number	ID	000123	
PCS (Count)	QT	+904	PC
Weight	WT	+2.048	kg
Unit Weight	UW	+2.2648	g
	ID	000123	
	QT	+926	PC
	WT	+2.098	kg
	UW	+2.2648	g
No. of Accum.	N	2	
TOTAL	TOTAL	+1830	PC

OP-03 Computer Connection

RS-232C Pin Connection

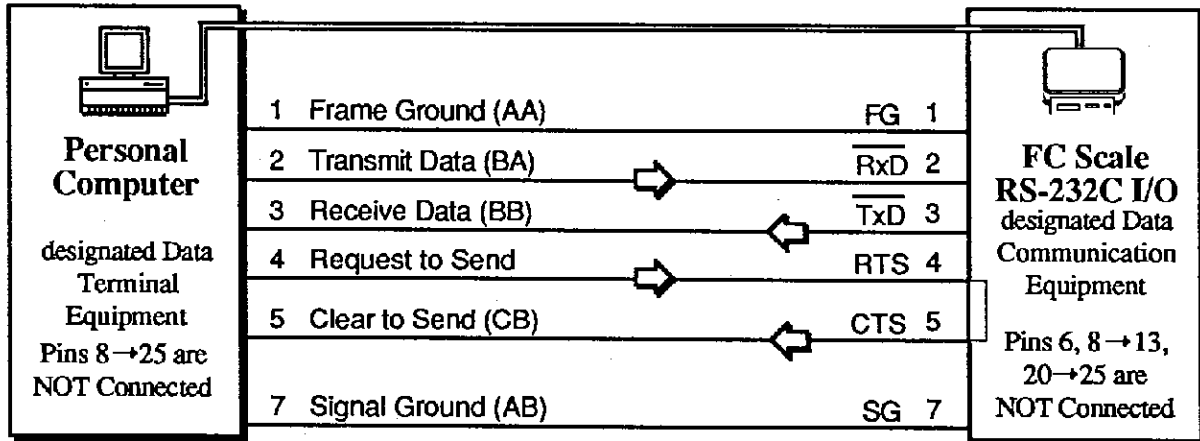

- A 25-pin RS-232C male connector and cover (HDB-25P & HDB-CTF) is not provided with this option.
- Use a high quality modem type cable between the computer and scale. For example: NEC PC-8895, Epson cable set #705, #724.
- AD-8117 is supplied with a cable for connection to the scale.

External Control Signal Input

- There are 5 External Control Signals (CSI) which can be user set. Please see page 7-14 for F-Function information on the CSI settings. Listed below are the factory setting for CSI 1→5.

CSI #	Action, <input type="checkbox"/> = key.	F-Function
CSI 1	Enter, <input type="checkbox"/> ENTER .	F-7-1
CSI 2	Tare, <input type="checkbox"/> TARE .	F-7-2
CSI 3	Zero, <input type="checkbox"/> ZERO .	F-7-3
CSI 4	Sample, <input type="checkbox"/> SAMPLE .	F-7-4
CSI 5	Reset, <input type="checkbox"/> RESET .	F-7-5

OP-03 Circuit Diagram

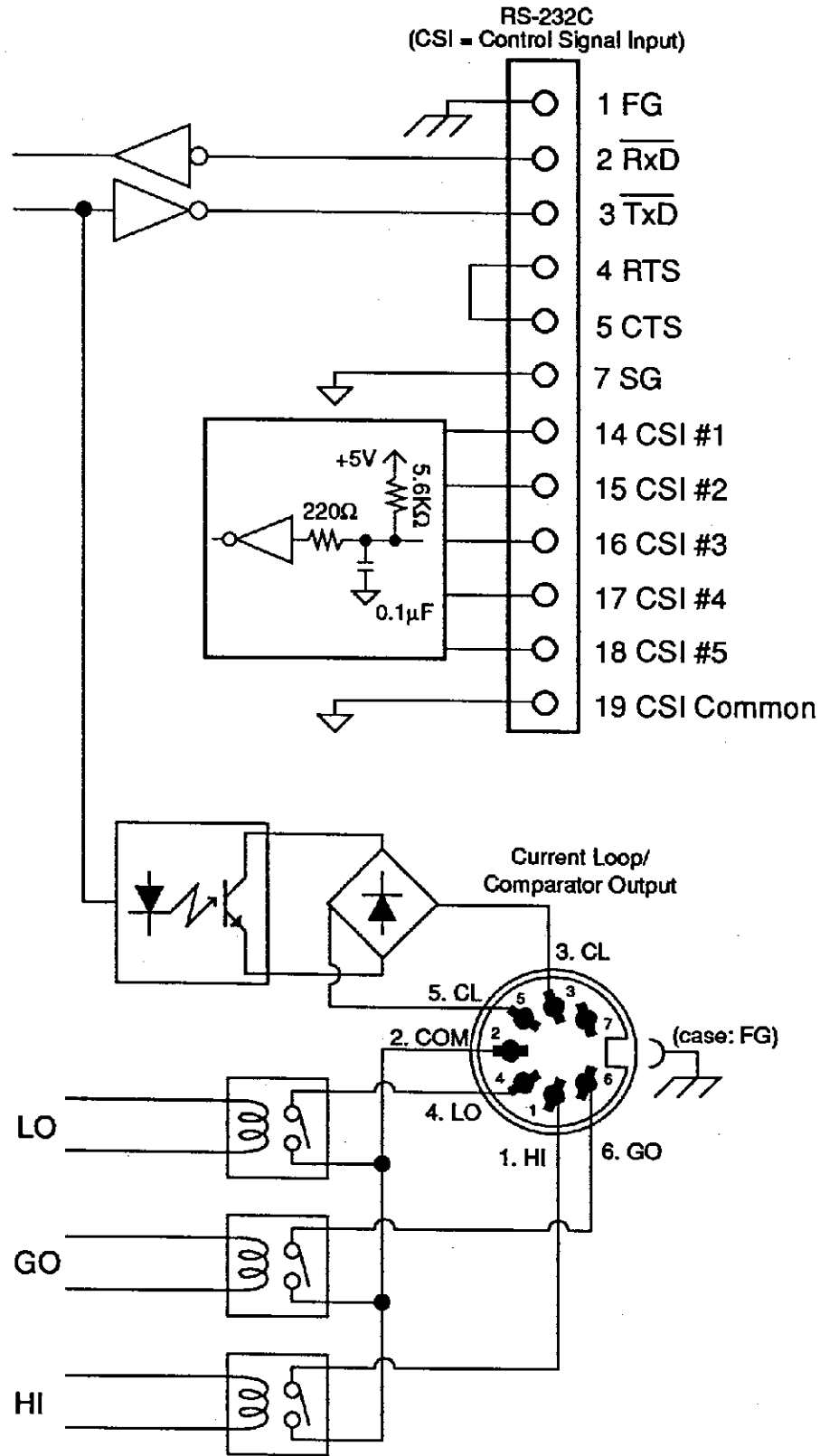

Other pin numbers for the RS-232C or Current Loop interfaces are not connected.



Data Format

1 ID Number (reply to ?ID)

1	2	3	4	5	6	7	8	9	10	11
I	D	,	0	0	0	1	2	3	␣	LF

2 PCS (Count) Data (reply to ?QT)

1	2	3	4	5	6	7	8	9	10	11	12	13	14	15	16	17
Q	T	,	+	0	0	0	0	1	2	3	4	␣	P	C	␣	LF
U	S	,	-	0	0	0	0	5	6	7	8	␣	P	C	␣	LF
O	L	,	+	9	9	9	9	9	9	9	9	␣	P	C	␣	LF

Stable Positive Data

Unstable Negative Data

'E' Display

3 Weight Data (reply to ?WT)

1	2	3	4	5	6	7	8	9	10	11	12	13	14	15	16	17
W	T	,	+	0	0	1	.	2	3	4	6	␣	k	g	␣	LF
W	T	,	-	0	0	2	.	7	2	5	5	␣	l	b	␣	LF
U	S	,	-	0	0	1	2	.	3	4	6	␣	l	b	␣	LF
U	S	,	+	0	0	0	5	.	5	9	3	␣	k	g	␣	LF
O	L	,	+	9	9	9	9	.	9	9	9	␣	k	g	␣	LF
O	L	,	-	9	9	9	9	.	9	9	9	␣	l	b	␣	LF

Stable Positive Data

Stable Negative Data

Unstable Negative Data

Unstable Positive Data

'E' Display

'-E' Display

4 Unit Weight (reply to ?UW)

1	2	3	4	5	6	7	8	9	10	11	12	13	14	15	16	17
U	W	,	+	1	.	2	3	4	5	6	7	␣	␣	g	␣	LF
U	W	,	+	0	.	2	7	2	5	3	1	␣	l	b	␣	LF

5 Total Count (reply to ?AQ)

1	2	3	4	5	6	7	8	9	10	11	12	13	14	15	16	17
A	Q	,	+	0	0	9	9	9	9	9	9	␣	P	C	␣	LF

6 Accumulation Numbers (reply to ?AN)

1	2	3	4	5	6	7	8	9	10	11	12	13
A	N	,	0	0	0	0	1	2	3	4	␣	LF

7 Tare Weight (reply to ?TR)

1	2	3	4	5	6	7	8	9	10	11	12	13	14	15	16	17
T	R	,	+	0	0	1	.	2	3	4	6	␣	k	g	␣	LF



Commands

Command	Definition	Notes
	Start/Stop continuous data transmission.	
A	Same as RESET key.	Key command
D	Set the known TARE weight.	D , 1 . 2 3 CF LF sets the TARE weight as '1.23kg'
E	Store unit weight to ID memory.	E , 1 2 3 CF LF stores to ID-123
F	Recall unit weight from ID memory.	F , 2 3 4 CF LF recalls from ID-234
G	Set a known unit weight.	G , 0 . 1 2 3 CF LF sets the unit weight as '0.123kg' (or '0.123 lb')
I	Same as REMOTE SCALE key.	Key command
J	Same as TOTAL key.	Key command
K	Same as M+ key.	Key command
P	Same as STANDBY OPERATE key.	Key command
Q	Send data immediately.	Data depends on F-6-2
S	Send stable data after accepting command.	Data depends on F-6-2
T	Same as TARE key.	Key command
X	Request list of internal function parameters.	
Y	Request list of ID memory contents.	
Z	Same as ZERO key.	Key command
O N	Turn the display ON.	
O F F	Turn the display OFF.	

continues...

Command	Definition	Notes
? I D	Send ID number in use.	<i>Refer to Data Format for reply (previous page)</i>
? Q T	Send PCS (count) data.	
? W T	Send weight data.	
? U W	Send unit weight in use.	
? A Q	Send TOTAL (accumulated) M+ memory count data.	
? A N	Send number of additions to M+ memory.	
? T R	Send TARE weight in use.	
? M R	Send specified ID memory contents.	See note 1 (next page).
M R	Memorize specified ID memory values.	See note 2 (next page).
C M	Clear memorized unit weight.	C M , 1 2 3 \overline{C} LF clears ID-123 contents
? F C	Send specified F-Function setting.	See note 3 (page 10-14).
F C	Memorize specified F-Function setting value.	See note 4 (page 10-14).

Acknowledgment & Error Codes

- ▶ When the FC receives an external command, it reacts as follows:
 - ❑ If the command requests a data reply, the scale will send the data. For other commands, the scale will send an acknowledgement <AK> (06H) upon acceptance of the command.
 - ❑ If the command is I, S, T, or Z, the scale will send a second acknowledgement <AK> (06H) when the command operation is completed.

- ▶ If an error occurs, the FC will send an error code.
 - ❑ The error format is E C , E n \overline{C} LF, 'n' being error number.

E 0	Communications Error	Parity error, framing error, etc.
E 1	Undefined command Error	Command does not exist for the FC.

E 2	Scale not ready Error	FC is not in a state where a command could be executed.
E 4	Too many characters Error	Command contains too many characters.
E 6	Format Error	Command contains invalid character.
E 7	Out of range Error	Value is out of range. Tare weight is more than capacity, etc.

1 Note 1 • ? M R Command Examples

Send  1 2 3 4 5 6 7 8 9

?	M	R	,	1	2	3	␣	␣
---	---	---	---	---	---	---	---	---

 Request the FC to reply with the contents of ID-123.
 ID # 1

Reply 

M	R	,	1	2	3	,	1	2	.	3	4	5	,	6	.	7	8	9	0	␣	␣
---	---	---	---	---	---	---	---	---	---	---	---	---	---	---	---	---	---	---	---	---	---

 ID # 1 Unit Weight Tare Weight

Send  1 2 3 4 5

?	M	R	␣	␣
---	---	---	---	---

 Request the FC to reply with the contents of the next ID number.

Reply 

M	R	,	1	2	4	,	2	3	.	4	5	6	,	7	.	8	9	0	5	␣	␣
---	---	---	---	---	---	---	---	---	---	---	---	---	---	---	---	---	---	---	---	---	---

 ID # 1 Unit Weight Tare Weight

2 Note 2 • M R Command Examples

Send  1 2 3 4 5 6 7 8 9 10 11 12 13 14 15 16 17 18 19 20 21 22

M	R	,	X	X	X	,	X	X	X	X	X	,	X	X	X	X	X	X	␣	␣
---	---	---	---	---	---	---	---	---	---	---	---	---	---	---	---	---	---	---	---	---

 ID # 1 Unit Weight Tare Weight

- ▶ Memorize (enter) into the FC memory a specified ID number with a Unit and an optional TARE weight.
 - ID Number: Maximum 3 digits
 - Unit Weight: Maximum 7 digits, including decimal point ('g' or 'lb' (lb/1000pcs) depends on F-8 settings, see 7•14).
 - Tare Weight: Maximum 7 digits, including decimal point ('kg' or 'lb' (Optional) depends on F-8 settings, see 7•14).

Send  1 2 3 4 5 6 7 8 9 10 11 12 13 14 15 16

M	R	,	9	,	1	.	0	,	0	.	4	2	5	␣	␣
---	---	---	---	---	---	---	---	---	---	---	---	---	---	---	---

 ID # Unit Weight Tare Weight
 ○ ID Number: 009
 ○ Unit Weight: 1.0g
 ○ Tare Weight: 0.425kg

Reply  FC enters the values and replies: <AK> (06H)

3 Note 3 • ? F C Command Examples

Send  1 2 3 4 5 6 7 8

?	F	C	,	5	1	⏎	LF
---	---	---	---	---	---	---	----

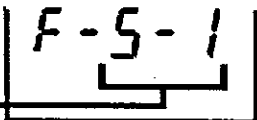
 Request the FC to reply with the setting of F-Function F-5-1.

Reply 

F	C	,	5	1	,	0	⏎	LF
---	---	---	---	---	---	---	---	----

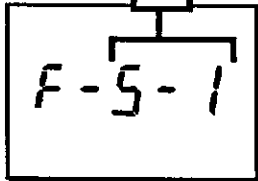

<input type="checkbox"/>	Comparator Mode.
0	Comparator OFF.
1	Compare all data.

 The FC replies that F-5-1 is set at '0' (see page 7-12).

Send  1 2 3 4 5

?	F	C	⏎	LF
---	---	---	---	----

 Request the FC to reply with the setting of the next F-Function.

Reply 

F	C	,	5	2	,	0	⏎	LF
---	---	---	---	---	---	---	---	----

 The FC replies that F-5-2 is also set at '0' (see page 7-12).

4 Note 4 • F C Command Examples

Send  1 2 3 4 5 6 7 8 9 10 11 12 13 14 15

F	C	,	X	X	,	X	X	X	X	X	X	X	⏎	LF
---	---	---	---	---	---	---	---	---	---	---	---	---	---	----

└─ F-# ─┘ └─ Setting (up to 7 digits) ─┘

- Input a specified F-Function number with a Setting.
 - F-Function: 2 digits
 - Setting: Maximum 7 digits, including decimal point.
- When finished with a setting F-Functions session, send the 'ON' command to enter and store the setting change into memory.

Example:

Send  1 2 3 4 5 6 7 8 9 10 11 12

F	C	,	5	3	,	1	2	3	4	⏎	LF
---	---	---	---	---	---	---	---	---	---	---	----

└─ F-# ─┘ └─ Setting ─┘

 F-Function: F-5-3
 Setting: 1234 Upper Limit

Reply  FC inputs the setting and replies: <AK> (06H)

Send  1 2 3 4

O	N	⏎	LF
---	---	---	----

 Having finished, send the 'ON' command to enter and store the setting change into memory.

Reply  FC stores the setting, resets the display and replies: <AK> (06H)



FC Counting Scales

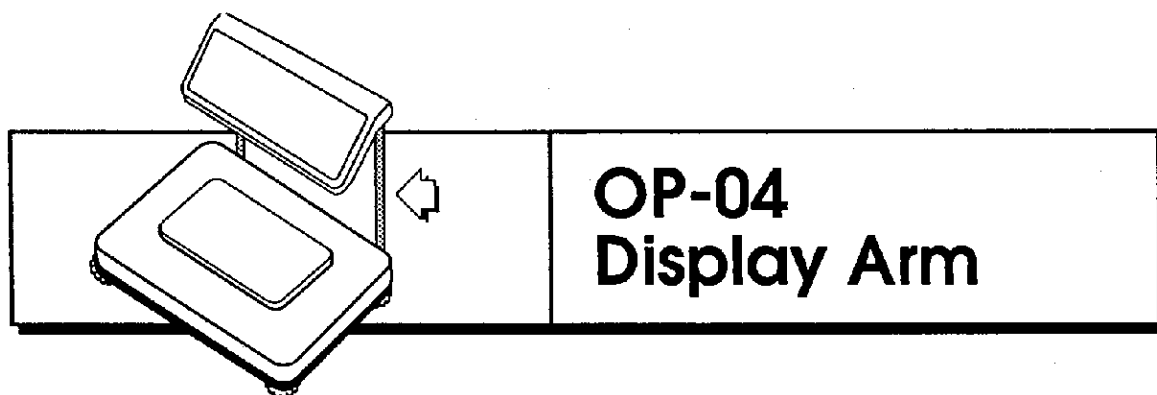



OP-04 Installation

1 Disconnect the AC/DC adaptor from the balance, and open the front cover as shown.

2 Remove the two screws and panel covering the Remote Scale slot.

3 Carefully pull the display cable downward to free it.

4 Replace the two screws, with star washers, and panel covering the Remote Scale slot.

5 Loosen the two lock-screws and remove the display pod support plates. Remove display pod.

6 Remove the screw, and the blank plate on the back of the display pod, holding the cable. Change cable direction as shown and replace the cover.

7 Place the Display Arm into the scale's platform and tighten the knobs.

8 Attach the display pod over the display arm as shown and tighten the two screws to fix the display pod.

9 Attach the cable clamps on the arms to hold the cable. Use the adjusting knobs to adjust the display angle. 

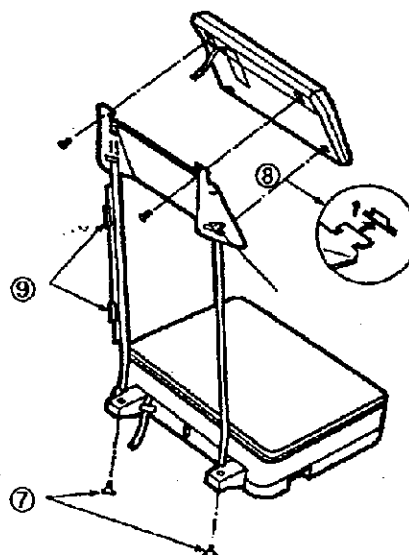
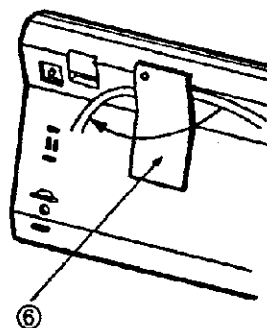
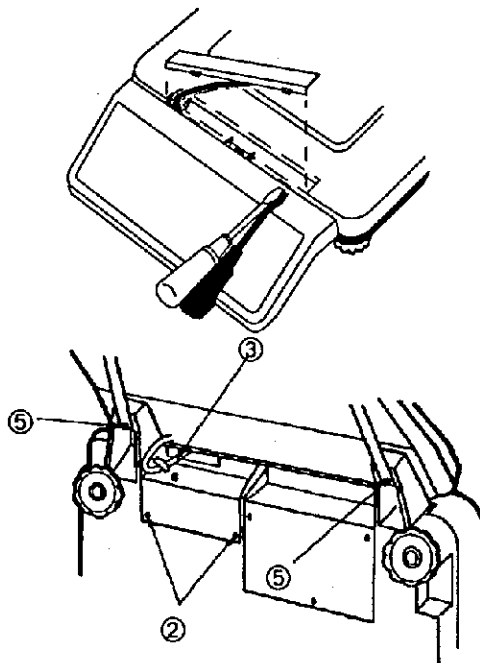



FC Counting Scales

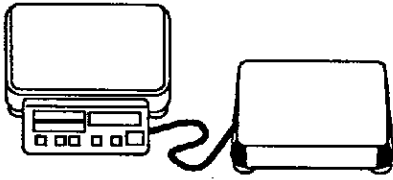

OP-05 Remote Scale Connector



OP-05 Remote Scale Connector



A two scale system using the FC is possible by installing OP-05 and connecting a remote scale. You can use remote platforms available through OP-09, or any other load cell platform that meets the conditions in this section.



OP-05 Installation

1

- ▶ Disconnect the AC/DC adaptor from the balance.

2

- ▶ Remove the two screws and panel covering the Remote Scale slot.

3

- ▶ Connect the OP-05 unit with the connector in the FC.

4

- ▶ Replace the two screws, with star washers, and panel covering the Remote Scale slot. Connect the AC/DC adaptor from the balance. Earth the chassis if you think static electricity may be a problem.

- ⚠ If you are not using the remote scale, replace the protective screw cap.

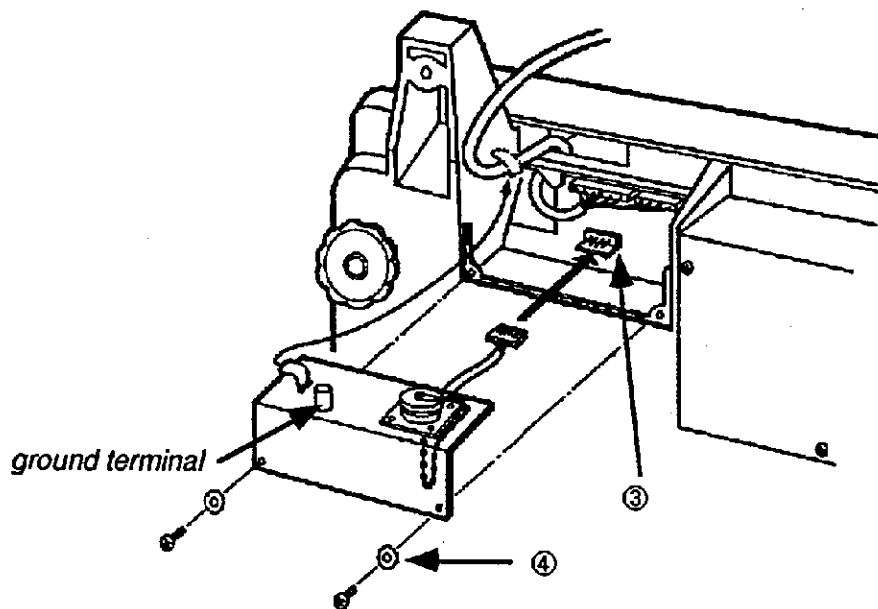



Remote Scale Connection



- If you have an option OP-09 platform which has been previously calibrated to your FC scale, then you only have to connect it to option OP-05 Load Cell connector, and use.

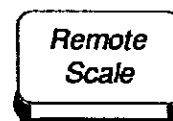

- ⚠ If you obtain the FC main scale and the OP-09 remote scale separately, you will have to set the capacity of the remote scale and calibrate it (see 12-5 and APPENDIX D - CALIBRATION).
- ⚠ It is of course recommended that you calibrate both the main and remote scales at the work site.



Notes on Using the Remote Scale

- ▣ To get a highly accurate counting unit weight, use the main scale to register unit weight and use the ACAI feature. After registration, switch back to the remote scale to count.
- If F-1-3 is set at "1", then the FC scale will automatically switch to the remote scale after unit weight (by sample pieces) is registered by the main scale (see p. 7-7).

- ⚠ Pressing the **SAMPLE** key will always return the FC to the main scale.

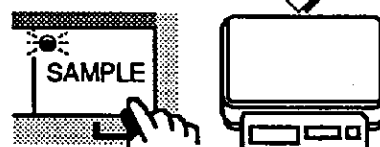

- ▣ Be aware that both the main and remote scales can have separate TARE values. So, if you want to use a TARE container on both, it must be registered on both.
- ▣ F-Function F-1-6 can be set so the remote scale has an independent unit weight, or is restricted to the same as the main scale (see p. 7-8).



Load Cell Connection



With an excitation voltage of 6V DC, the FC has the capability of driving up to 4 load cells (350Ω) in parallel, in a remote scale (platform), set for the capacity range as shown below:

Capacity
Range
Table
→

Model	Capacity Range	
FC-500	500g → 500kg	1 lb → 1,000 lb
FC-1000	1kg → 1,000kg	2 lb → 2,000 lb
FC-2000	2kg → 2,000kg	5 lb → 5,000 lb
FC-5000	5kg → 5,000kg	10 lb → 10,000 lb
FC-10K	10kg → 5,000kg	20 lb → 10,000 lb
FC-20K	20kg → 5,000kg	50 lb → 10,000 lb
FC-31K, 50K	50kg → 5,000kg	100 lb → 10,000 lb

Specifications

- ▣ **Minimum Output** at zero point is 1mV.
- ▣ **Maximum Output** at full output is 18mV.
 - Excitation voltage of the FC series is 6V.
- ▣ **Capacity Range** see table, previous page.
- ▣ **Cable Length** should be kept under 5m (16.5 ft.) for higher accuracy.
- ▣ **Pin Connection (JM:NJC-207-PF):**

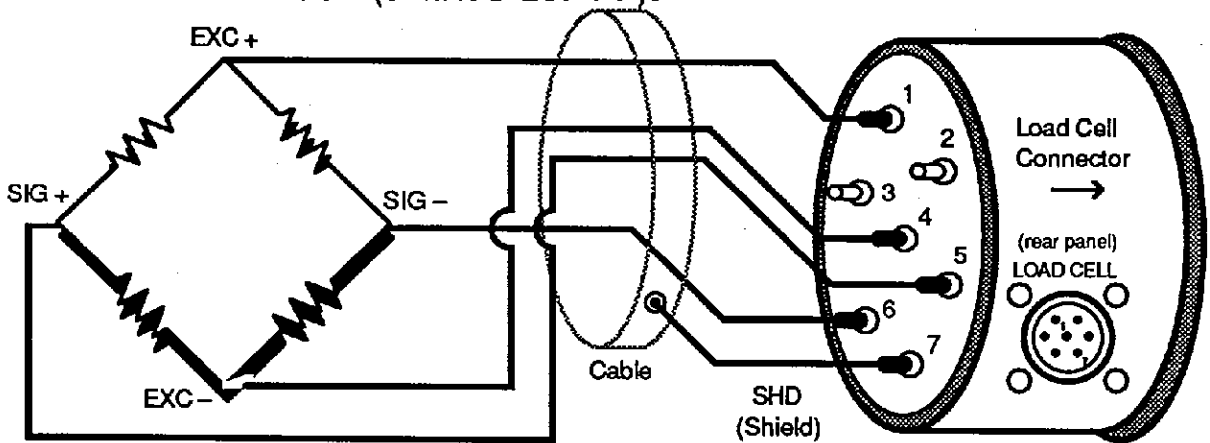

Load Cell Connections			
Pin	Signal	Pin	Signal
1	Positive Excitation Voltage (EXC+)	5	Positive Signal Voltage (SIG+)
2	N.C.	6	Negative Signal Voltage (SIG-)
3	N.C.	7	Shield (SHD)
4	Negative Excitation Voltage (EXC-)		



- ⚠ *The analogue output from the load cells and the RS-232C input/output signals are sensitive to electrical noise. Do not bind these cables together as it could result in cross-talk interference. Please also keep them well away from AC power cables.*
- ⚠ *You may use a 4 wire cable with shield, but please note proper pin connections to the FC load cell connector.*

The Load Cell and Input Sensitivity

The relationship between Load Cell and Input Sensitivity (X) for the FC is:

□ Example	Load Cell Capacity	100kg	"A"
	Rated Output	3mV/V	"B"
	Min. Division of Display	0.01kg	"D"

- When a single Load Cell without a lever is used, the following formula should apply:

$$"X" = \frac{6,000 \times B \times D}{A}$$

- System design will be satisfactory if "X" is greater than 0.5µV. In the example above "X" = 1.8µV.

Capacity and Resolution



The resolution of the remote scale is automatically determined during the calibration procedure. The following is to enable you to calculate the resolution for a given capacity.

1 ▶ Decide the capacity value, assign it to "W_s". Maximum 5 digits.

2 ▶ Get the maximum count, "N_s", for the capacity. Add "0"s to W_s until it is 5 digits.

3 ▶ Calculate: $d' = N_s / 10,000$.

4 ▶ Decide the minimum division "d".

- $d' = 1 \rightarrow d = 1$
- $2 \geq d' > 1 \rightarrow d = 2$
- $5 \geq d' > 2 \rightarrow d = 5$
- $d' > 5 \rightarrow d = 10$ This should be changed to $d = 1$, dividing N_s by 10.

5 ▶ Now "N_s x d" and the resolution $1/N_o. = d/N_s$ can be determined.

step	Parameters	Example 1	Example 2	Example 3
1	W _s	200kg	30.0kg	600kg
2	N _s	20,000	30,000	60,000
3	d'	2	3	6
4	d	2 (=0.02kg)	5 (=0.005kg)	10 (=0.1kg)
5	N _s x d	20,000 x 2	30,000 x 5	6,000 x 1
5	1/N _{o.}	1/10,000	1/6,000	1/6,000

6 ▶ Calculate the voltage sensitivity "e_s".

$$e_s = (a_s - a_o) \times 6,000 \times 1/N_o. (\mu V) \quad ["6,000" \text{ means excitation voltage of } 6V]$$

a_o: Load cell output at zero point (mV/V)

a_s: Load cell output at full capacity (mV/V)

7

- ▶ Check the voltage sensitivity " e_s ".

$e_s \geq 0.5\mu\text{V}$ → Calculated " $N_s \times d$ " is fixed. In Example 3 (previous table), a 600kg x 0.1kg scale will be obtained.

$e_s < 0.5\mu\text{V}$ → Change " d " for new resolution $1/\text{No.}$.

$$d = 1 \rightarrow 2$$

$$d = 2 \rightarrow 5$$

$$d = 5 \rightarrow 10 \rightarrow 1 \text{ (dividing "N}_s\text{" by 10).}$$

In Example 1 the new $d = 5$

$$1/\text{No.} = d/N_s = 5/20,000 = 1/4,000$$

Using new $1/\text{No.}$, go to step 6 and repeat it and step 7 until $e_s \geq 0.5\mu\text{V}$.



Remote Scale kg/lb relationship

USA Version
ONLY

- ▶ When capacity was set by "kg":

Let Capacity x Minimum Division = $W_s \times W_d$ (kg)
when:

$$d = 1, \text{ then } W_d \text{ (lb)} = W_d \text{ (kg)} \times 2$$

$$d = 2, \text{ then } W_d \text{ (lb)} = W_d \text{ (kg)} \times 5/2$$

$$d = 5, \text{ then } W_d \text{ (lb)} = W_d \text{ (kg)} \times 2$$

and: W_s (lb) is equal to W_d (lb) x No.

Example: $15\text{kg} \times 0.002\text{kg}$, No. = $15\text{kg}/0.002\text{kg} = 7,500$

$$W_d \text{ (lb)} = 0.002 \times 5/2 = 0.005 \text{ (lb)}$$

$$W_s \text{ (lb)} = 0.005 \times 7,500 = 37.5 \text{ (lb)}$$

- ▶ When capacity was set by "lb":

Let Capacity x Minimum Division = $W_s \times W_d$ (lb)
when:

$$d = 1, \text{ then } W_d \text{ (kg)} = W_d \text{ (lb)} \times 1/2$$

$$d = 2, \text{ then } W_d \text{ (kg)} = W_d \text{ (lb)} \times 1/2$$

$$d = 5, \text{ then } W_d \text{ (kg)} = W_d \text{ (lb)} \times 2/5$$

and: W_s (kg) is equal to W_d (kg) x No.

Example: $30 \text{ lb} \times 0.005 \text{ lb}$, No. = $30 \text{ lb}/0.005 \text{ lb} = 6,000$

$$W_d \text{ (kg)} = 0.005 \times 2/5 = 0.002 \text{ (kg)}$$

$$W_s \text{ (kg)} = 0.002 \times 6,000 = 12 \text{ (kg)} \quad \text{IV}$$



FC Counting Scales



**OP-07 Display Pod
Wall Mounting Kit**

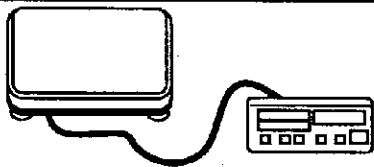

**OP-08 Display Pod
Extension Cable**



OP-07 Wall Mounting Kit



The display pod can be separated from the main scale and mounted on a wall or similar panel. Included in the OP-07 Wall Mounting Kit is an OP-08 2m Extension Cable. You will need to first install the 2m Extension Cable, then mount.

1

First, install the 2m Extension Cable as described in the next section, OP-08 2M EXTENSION CABLE.

2

Fasten the two hanging screws to the back of the Display Pod.

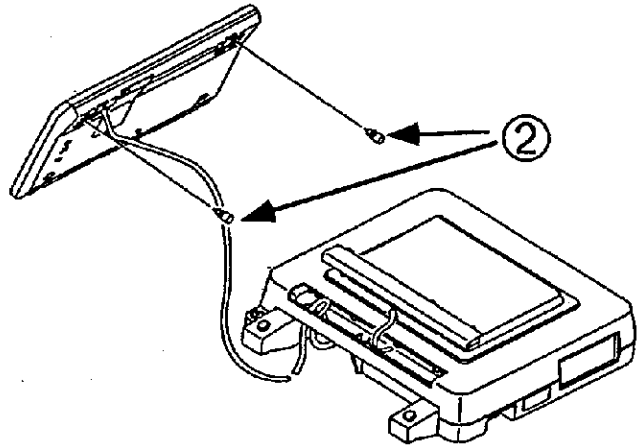

3

Attach the wall mounting plate to the wall with the two tapping screws.

4

Slide the tops of the hanging screws into the holes of the wall mounting plate.

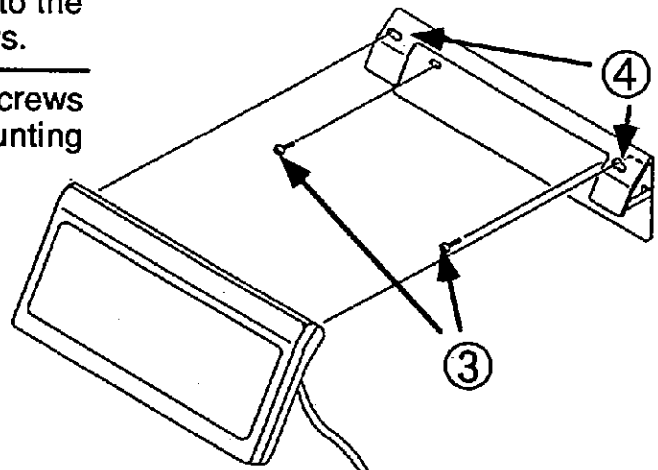

Hanging Screw



Tapping Screw





OP-08 2m Extension Cable



The display pod can be separated from the main scale by using OP-08 2m Extension Cable. Additionally, the Display Pod can be wall mounted using OP-07.



OP-08 Installation

1 Disconnect the AC/DC adaptor from the balance.

2 Remove the two screws and panel covering the Remote Scale slot.

3 Carefully disconnect the two cable connectors from the scale's connectors **1**. Remove the cable.

4 Loosen the two lock-screws **2** and remove the display pod support plates **3**. Remove display pod.

5 Thread the 2m cable **4** through and connect the cable connectors to the scale connectors **5**.

6 Replace the two screws, with star washers, and panel covering the Remote Scale slot.

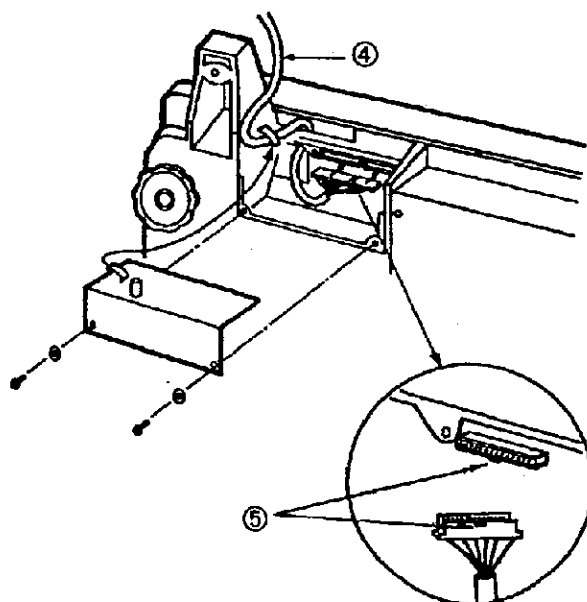
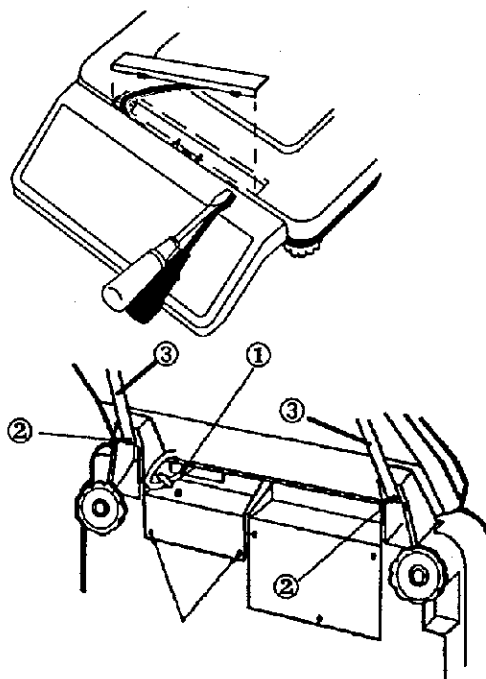

7

Remove the screw ⑥, and the blank plate on the back of the display pod, holding the cable.

8

Carefully disconnect the two cable connectors from the display pod's connectors. Remove the cable.

9

Place the 2m cable ⑦ as shown and connect the cable connectors to the display pod's connectors (the larger connector should be towards the outside of the display pod. **IV**)

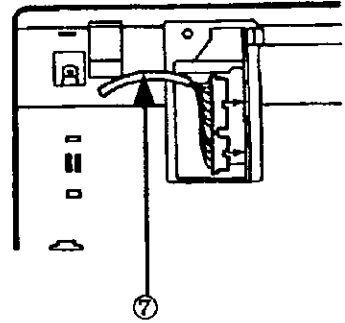
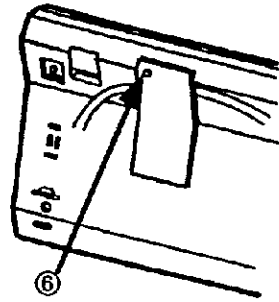



FC Counting Scales

For more information, see Appendix...

Appendix A

Center of ZERO

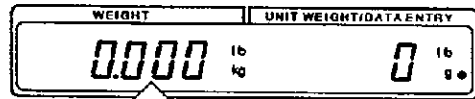
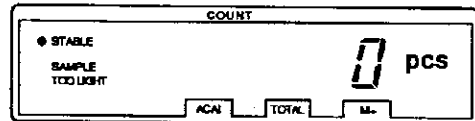

- CENTER OF ZERO
- TARE ENTERED
- REMOTE SCALE



APPENDIX A



Center of ZERO

- ☉ CENTER OF ZERO
- TARE ENTERED
- REMOTE SCALE



The FC scale is highly sensitive instrument, and therefore attention must be paid to keeping the its reference point - ZERO - true. You should be aware of when the CENTER OF ZERO lamp should be ON and what it means.

- ▶ The CENTER OF ZERO lamp will come ON to indicate that the weighing pan is empty, and ready to start to register a weight, wether it be a unit weight or tare weight.

- ☉ CENTER OF ZERO
- TARE ENTERED
- REMOTE SCALE

- ▶ The **ZERO** key will bring the WEIGHT display back to ZERO as long as the weighing pan is empty or within 5% of capacity.

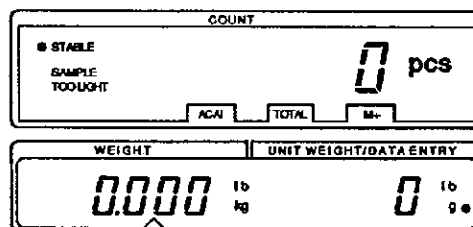

- ☉ CENTER OF ZERO
- TARE ENTERED
- REMOTE SCALE

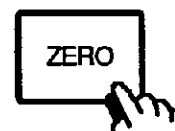

- ▶ If the **ZERO** key will not bring the display back to ZERO, make sure that there is nothing touching the weighing pan, or any other problem (see BEST CONDITIONS FOR WEIGHING section, page 1•7).
- ▶ There is automatic re-ZEROing function called "ZERO Tracking". The scale initially comes with this function ON to take care of normal drifts from ZERO caused by changes in temperature, humidity, air pressure, etc. (F-Function F-4-1, page 7•11).



FC Counting Scales

For more information, see Appendix...

Appendix B

"Add" Display

Sample Size is Not Enough

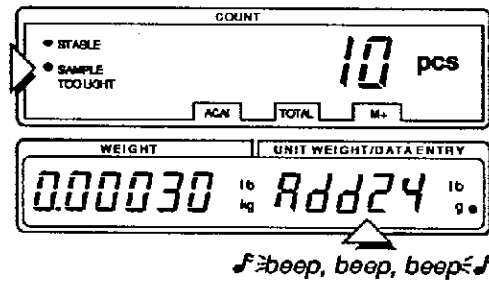

APPENDIX B

●●● "Add" Display Sample Size is Not Enough



If the sample size for Unit Weight registration is not enough (too light), the scale may ask you to put on more pieces for a more accurate reading.

The SAMPLE TOO LIGHT lamp will come ON and you will see an "Add" request on the UNIT WEIGHT display.

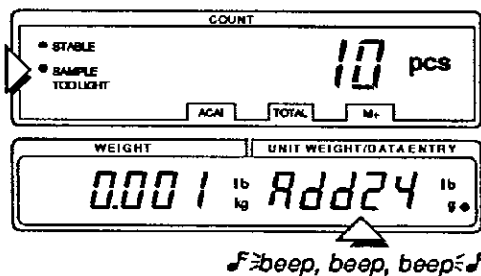

- ▣ There are two possible reactions to the "Add" request depending on how F-Function F-1-2 is set (see p. 7-7).
 - If F-1-2 is set at "0", then unit weight *can be entered* without adding more sample pieces (normal setting). So you have the choice of adding the requested sample pieces or ignoring the "Add" request and pressing the **ENTER** key to calculate the unit weight based just on the sample on the weighing pan.
 - ⚠ If the "Add" request is ignored by pressing the **ENTER** key, counting may not be highly accurate.
 - If F-1-2 is set at "1", then unit weight *can't be entered* without adding more sample pieces. This is a safety feature so counting is always the most accurate possible.

●●● Adding More Sample Pieces

- If the sample size for Unit Weight registration is not enough (too light), the SAMPLE TOO LIGHT lamp will come ON, beep, and you will see an "Add" request on the UNIT WEIGHT display.
- ▣ Place the additional number of sample pieces on the weighing pan (or in a tared container) as requested by the "Add" display, in this example, 24 pieces;
- ▣ Press the **ENTER** key.
 - The unit weight is calculated and displayed, along with the count.
 - ⚠ If the "Add" request appears again, then add the additional pieces and press the **ENTER** key again, until unit weight can be calculated.
- ▣ Continue counting. See APPENDIX C for ACAI information. **IV**

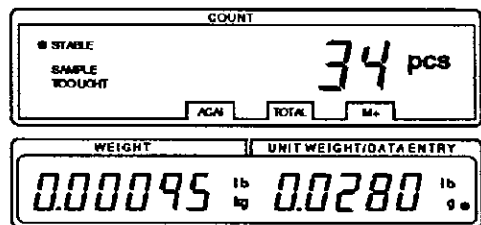
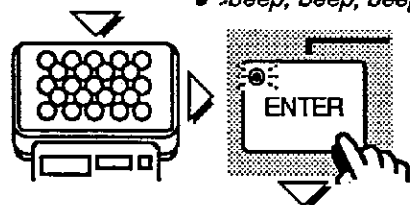
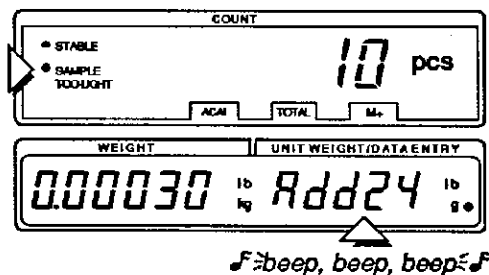

Ignoring the "Add" Request

- If the sample size for Unit Weight registration is not enough (too light), the SAMPLE TOO LIGHT lamp will come ON, beep, and you will see an "Add" request on the UNIT WEIGHT display.
- ▣ If you want to ignore the "Add" request, press the **ENTER** key.
- The unit weight is calculated based only on the sample on the weighing pan and then displayed.
- ⚠ The SAMPLE TOO LIGHT lamp will stay ON to remind you that the count is based on a rough unit weight that may not be accurate.
- ▣ Continue counting. See APPENDIX C (next page) for ACAI information. **VA**

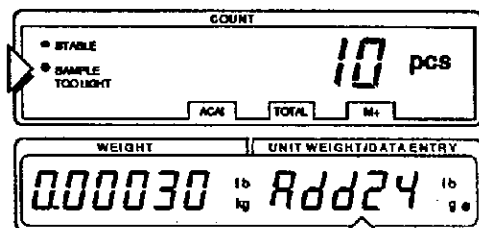

⚡beep, beep, beep⚡

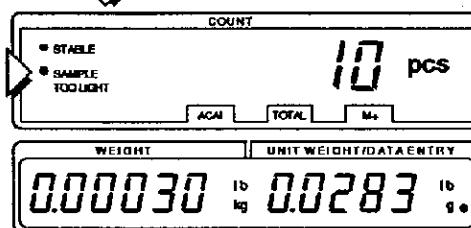
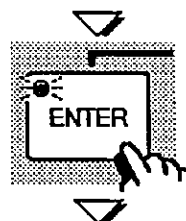



FC Counting Scales

*For more
information,
see Appendix...*

Appendix C

ACAI

Automatic Counting Accuracy
Improvement

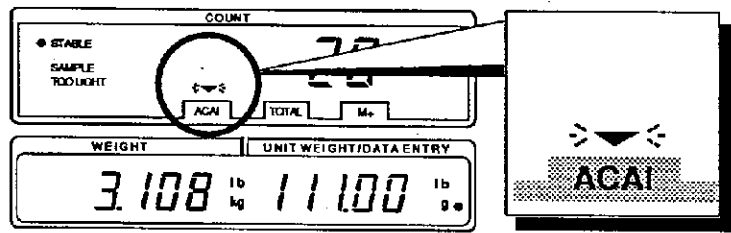

APPENDIX C



ACAI Automatic Counting Accuracy Improvement



The ACAI™ (Automatic Counting Accuracy Improvement) function recalculates the unit weight as more pieces are added, to improve count accuracy.

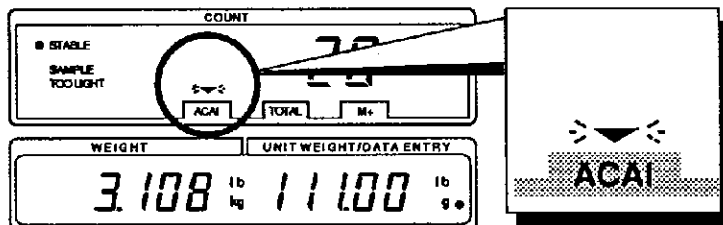

When the scale calculates unit weight from sample pieces, the more sample pieces that are used, the higher the accuracy. For example: let's say that you use 10 pieces (Simplified Operation) as your sample and the unit weight calculated by the scale from your sample is 1g. Using the ACAI feature, after loading on 200 pieces, the scale determines that the average unit weight is really 0.98g instead of 1g. This is improved accuracy and could make a big difference when you are counting thousands of pieces.

You need to stay within the ACAI counting range as you add more pieces. But this is easy to do and only needs to be done once, up to 500 pieces. After that, the ACAI remembers the most accurate unit weight.

- ❑ The ACAI function is initially set to •Automatic Operation when the unit weight is entered by sample pieces, and to •Manual Operation when the unit weight is set digitally by the keyboard, by ID memory, or using a computer via the Serial Interface OP-03. However, ACAI can be set to the Automatic Mode.
- ▶ The ACAI Mode when •Unit Weight is entered by sample pieces is controlled by F-Function F-2-1, or when •Unit Weight is entered by ID or Digital Input is F-Function F-2-2, see page 7-9.



ACAI Notes

- ❑ You must do the ACAI procedure just after you set the unit weight. Samples must be still on the weighing pan.
- ❑ Do not take the samples off until the end of the ACAI procedure.
- ❑ You don't have to count out the pieces when you add, just stay within the ACAI range.
- ❑ Continue the ACAI procedure to reach the largest amount that you will be counting (or 500 pieces).
- ❑ If you want the most precise counting results every time you count different batches of the same item, use ACAI every time you start counting the next batch.
- ❑ The ACAI does not work when you use a remote scale if the unit weight was set on the main scale and vice versa.
- ❑ The ACAI function is initially set to Manual Operation when the unit weight is set digitally by the keyboard, by ID memory, or using a computer via the Serial Interface OP-03 (to change, page 10-1).

ACAI Automatic Operation

1 ⚠ Please have read the previous ACAI NOTES section before starting. **REMEMBER:** • Do not take the samples off until the end of the ACAI procedure. • You don't have to count out the pieces when you add, just stay within the ACAI range.

- ☐ To start ACAI automatic operation, unit weight must be registered and the sample still on the weighing pan.

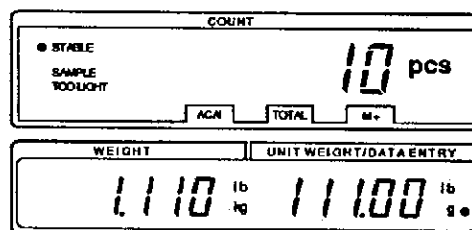
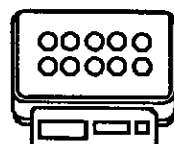

2 ☐ Add pieces within the nearest ACAI range (see table). A good rule of thumb is to double the amount on the weighing pan.

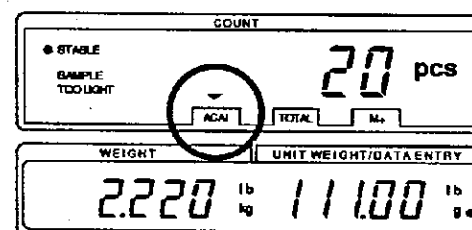
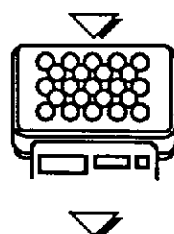

Pcs On the Weighing Pan	ACAI Addition Range		
10.....	13 - 24	60.....	63 - 108
20.....	23 - 47	70.....	73 - 118
30.....	33 - 65	80.....	83 - 128
40.....	43 - 81	90.....	93 - 138
50.....	53 - 95	100.....	103 - 300
		over 200.....	203 - 500...

○ STABLE

As you add, the annunciator will be ON as long as you are in range.

⊕ STABLE

When you stop adding and the display becomes STABLE, the annunciator will blink.

● STABLE

After the new unit weight is calculated, the annunciator will disappear.

3 ☐ Continue adding pieces within the ACAI range until you have reached a sample size as large as the largest number of pieces that you will be counting. For example, if you are going to be counting up to 300 bolts, follow the ACAI procedure until you have over 300 pieces on the weighing pan.

⚠ Please follow the guidelines in the previous ACAI NOTES section as long as you are adding pieces.

☐ When you have added the maximum number of pieces required, remove the sample pieces and start your counting job. **TV**



ACAI Manual Operation



- ❑ The ACAI procedure can also be controlled manually. The ACAI will not recalculate unit weight until the **ENTER** key is pressed (as long as it is at the proper time and the guidelines in the ACAI NOTES section have been followed).
- ▶ The ACAI manual mode is controlled by F-Function F-2-1, set at "1", see page 7-9.

1

⚠ Please have read the previous ACAI NOTES section before starting. **REMEMBER:** • Do not take the samples off until the end of the ACAI procedure. • You don't have to count out the pieces when you add, just stay within the ACAI range.

- ❑ To start ACAI manual operation, unit weight must be registered and the sample still on the weighing pan.

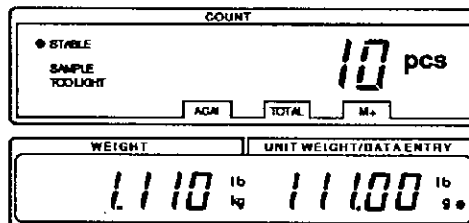
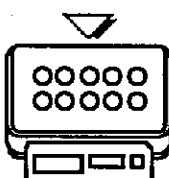

2

▶ Add pieces within the nearest ACAI range (see table). A good rule of thumb is to double the amount on the weighing pan.

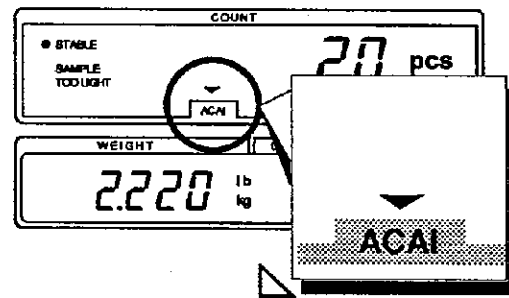
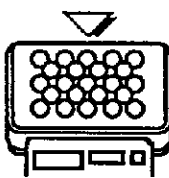

- As you add, the annunciator will stay ON as long as you are in ACAI range.

Pcs On the Weighing Pan	ACAI Addition Range	
10.....	13 - 24	60.....
20.....	23 - 47	70.....
30.....	33 - 65	80.....
40.....	43 - 81	90.....
50.....	53 - 95	100.....
		over 200.....
		63 - 108
		73 - 118
		83 - 128
		93 - 138
		103 - 300
		203 - 500...

3

▶ When you have the correct number of pieces, and the display is stable, press the **ENTER** key.

- As the unit weight is being calculated the annunciator will blink. When it is calculated, the annunciator will disappear.

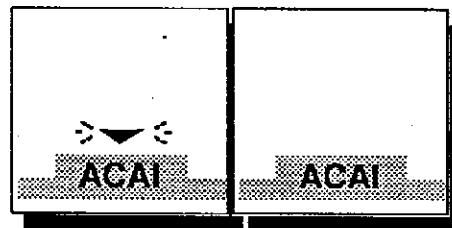
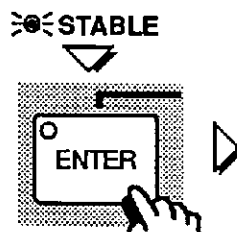

4

- ▶ Continue adding pieces within the ACAI range until you have reached a sample size as large as the largest number of pieces that you will be counting. For example, if you are going to be counting up to 300 bolts, follow the ACAI procedure until you have over 300 pieces on the weighing pan.
- ⚠ Please follow the guidelines in the previous ACAI NOTES section as long as you are adding pieces.
- ▶ When you have added the maximum number of pieces required, remove the sample pieces and start your counting job.



ACAI with ID or Digital Input



- The ACAI function is initially set to Manual Operation when the unit weight is set digitally by the keyboard, by ID memory, or using a computer via the Serial Interface OP-03. However, ACAI can be set to the Automatic Mode.
- ▶ The ACAI Mode When Unit Weight is entered by ID or Digital Input is controlled by F-Function F-2-2, see page 7-9. It is initially set at "0", ACAI Manual Mode. Set to "1" for Automatic Operation Mode.

1

- ⚠ Please have read the previous ACAI NOTES section before starting. REMEMBER: • Do not take the samples off until the end of the ACAI procedure. • You don't have to count out the pieces when you add, just stay within the ACAI range.

- To start ACAI Automatic OR Manual Operation, a unit weight must first be registered.

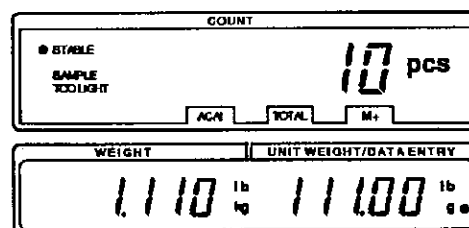
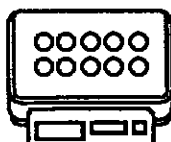

- ▶ Place 10 sample pieces on the weighing pan.

2

- Go to Step 2 in either the Automatic or Manual Operation sections preceding (depending on how F-Function F-2-2 is set, see discussion above).



FC Counting Scales

*For more
information,
see Appendix...*

Appendix D

Calibration

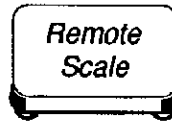
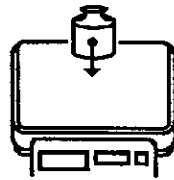

APPENDIX D



About Calibration



Calibration of the FC is required when it is initially installed, if it is moved often, or if it is moved a substantial distance. Calibration is also necessary in regular scale maintenance due to normal mechanical wear-and-tear, changes in seasonal temperature, humidity, air pressure, etc. ZERO Calibration can easily be done often, without SPAN Calibration, to help keep your scale highly accurate. See the next page for the ZERO & SPAN Calibration procedure and page D•4 for a full calibration flow chart.

- ⚠ The FC must be warmed up (plugged in) for at least 30 minutes before starting calibration.
- ⚠ During calibration, the weighing system must be kept stable for accurate adjustment.



Calibration is a very important to the accuracy of your FC scale. Just as a musician must have one true *tone* to tune his instrument, the FC scale needs a true *weight* to tune itself. The FC is a highly sensitive instrument and attention must be paid to keeping it "tuned" or calibrated. This calibration is done by giving it a base point (ZERO) – and establishing what its full capacity (SPAN) weight should feel like. Since SPAN is normally the scale's maximum capacity, the scale now has two precise extreme points – zero and full capacity. It can now accurately calculate all amounts in-between.



- ❑ **ZERO Calibration** is a procedure that tells the FC that there is nothing on the weighing pan. Thus, the FC has a base reference point, "zero", to compare to when weight is added to the weighing pan.

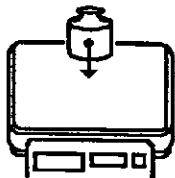

- ❑ **SPAN Calibration** is a procedure that tells the FC what a known true weight feels like, and what value to assign to that weight. For example, you give the FC-500 a "true" weight of 500g/1 lb – it knows then when something else weighs that amount, it is also 500g/1 lb.



- ⚠ If you are calibrating with a 2-scale system, please refer to the CALIBRATION PROCEDURE section on the following pages, and see the flow chart on page D•5 for the necessary extra steps.



- ⚠ If you are not using the listed calibrating mass weight for your FC model (see following page), please use a mass as close to the scale's maximum capacity as possible. The closer to maximum capacity, the more accurate the calibration.



- ⚠ The FC scale is equipped with gravity compensation which allows it to be calibrated in one location and then adjusted to match the acceleration of gravity at another location where it will be used. It is not intended for the average user, so – *Don't worry about it unless you need it!* See page D•7 for more information.



Calibration Procedure



- ⚠ The scale should have power connected for at least one-half hour to warm it up before starting the calibration procedure (see STANDBY MODE section, p. 1•8 for more information).
- ⚠ If highly accurate weighing (*not counting*) is needed for commercial purposes or other reasons, please use only a stainless steel OIML class F₁, or higher, calibration mass (you may input it's exact weight in step 3).

1

- ▶ Open the front cover as shown, being careful that the cable doesn't touch the weighing pan through out the calibration procedure.

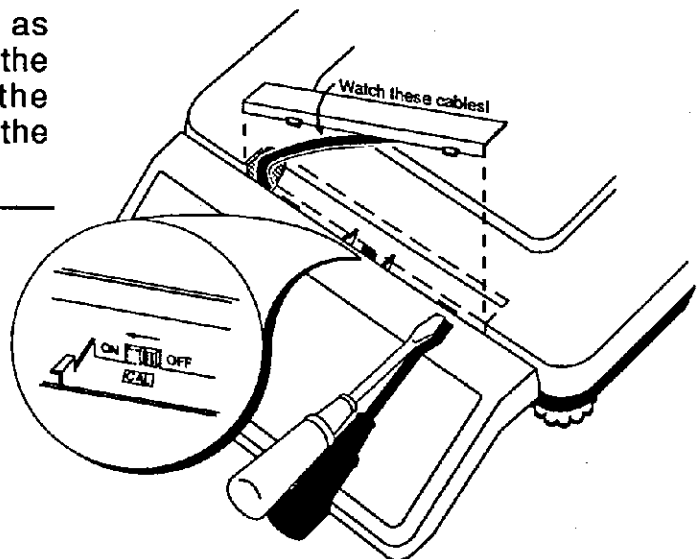

2

- ▶ With the display ON, slide the CAL switch to ON as shown.
- The display will show 'CAL', and a value may appear in the WEIGHT display, but disregard it.

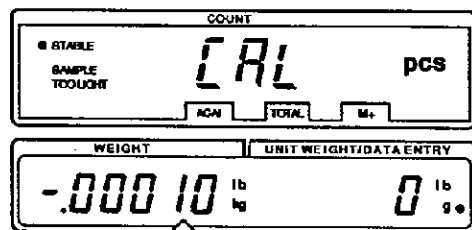

↑ A value may appear here, but disregard it.

3

- ▶ Press the **ZERO** key to enter into ZERO & SPAN calibration mode.
- The DATA ENTRY display will flash the required calibration mass (*in this example, 500g for an FC-500 in 'kg' mode*).

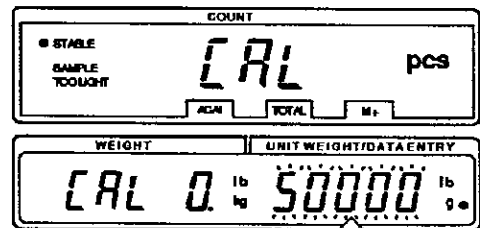
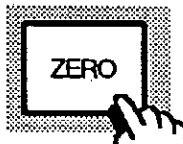

↑ Calibration Mass required

For Example

Model	CAL Mass
FC-500	500g / 1 lb
FC-1000	1kg / 2 lb
FC-2000	2kg / 5 lb
FC-5000	5kg / 10 lb

Model	CAL Mass
FC-10K	10kg / 20 lb
FC-20K	20kg / 50 lb
FC-31K	30kg / 75 lb
FC-50K	50kg / 100 lb

⚠ If you know the exact weight of your calibration mass, or if you wish to use a different mass then what is listed for your scale:



▶ Use the **0**→**9**, **.** keys to display the desired calibration mass weight.

○ For example: We know that our 500g calibration mass actually weighs 499.32g.

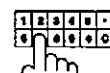
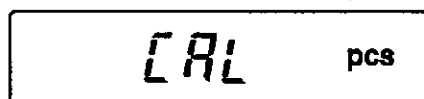
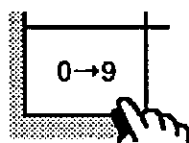

4

▶ Press the **ENTER** key.

○ The calibration mass weight will stop blinking.

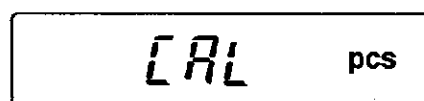
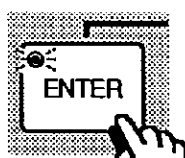

5

ZERO Calibration

▶ Making sure that there is nothing on, or touching, the weighing pan and the display is **STABLE** – press the **ENTER** key.

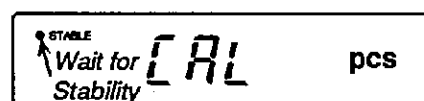
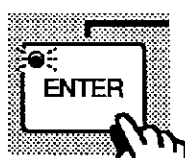

○ When ZERO calibration is completed the display will show "CAL F" and the calibration mass weight.

⚠ If you don't need SPAN calibration, press the **C** key and go to step 7 to exit.

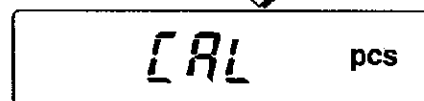

6

SPAN Calibration

▶ Place the calibration mass on the weighing pan.

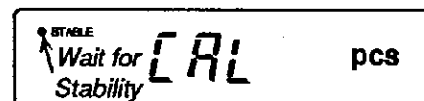
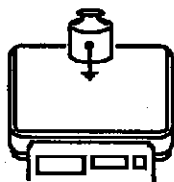

▶ When the display is **STABLE** – press the **ENTER** key.

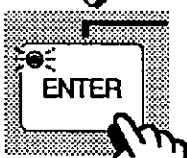

○ The Weight display will show the calibrated SPAN value.

⚠ If the SPAN mass is not what it should be, an error will be displayed.

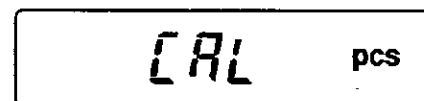

7

▶ Slide **OFF** the calibration switch and re-attach the front cover.

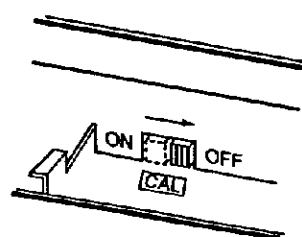



SPAN and ZERO Calibration Flowchart

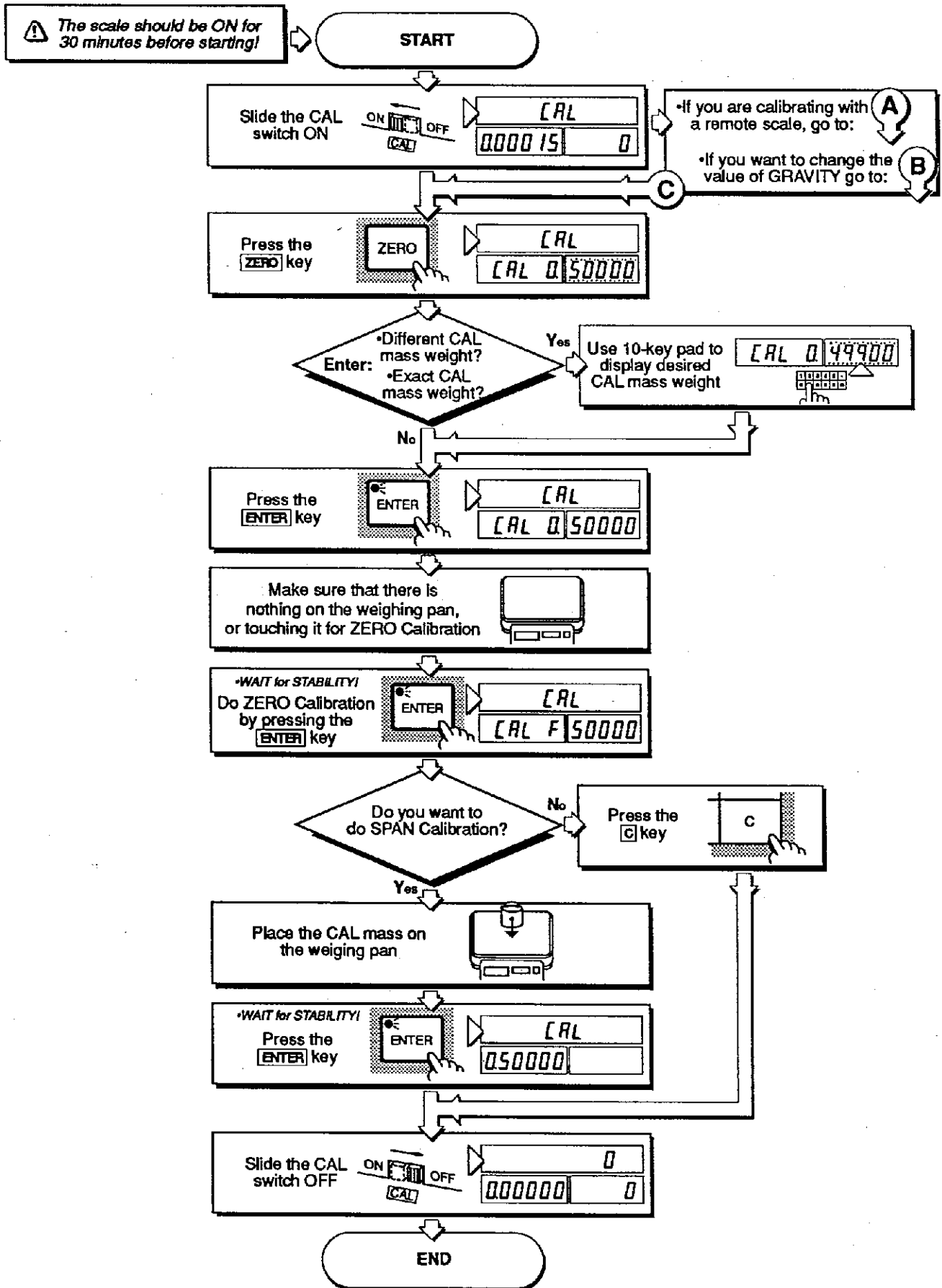

Calibration with a Second Scale A

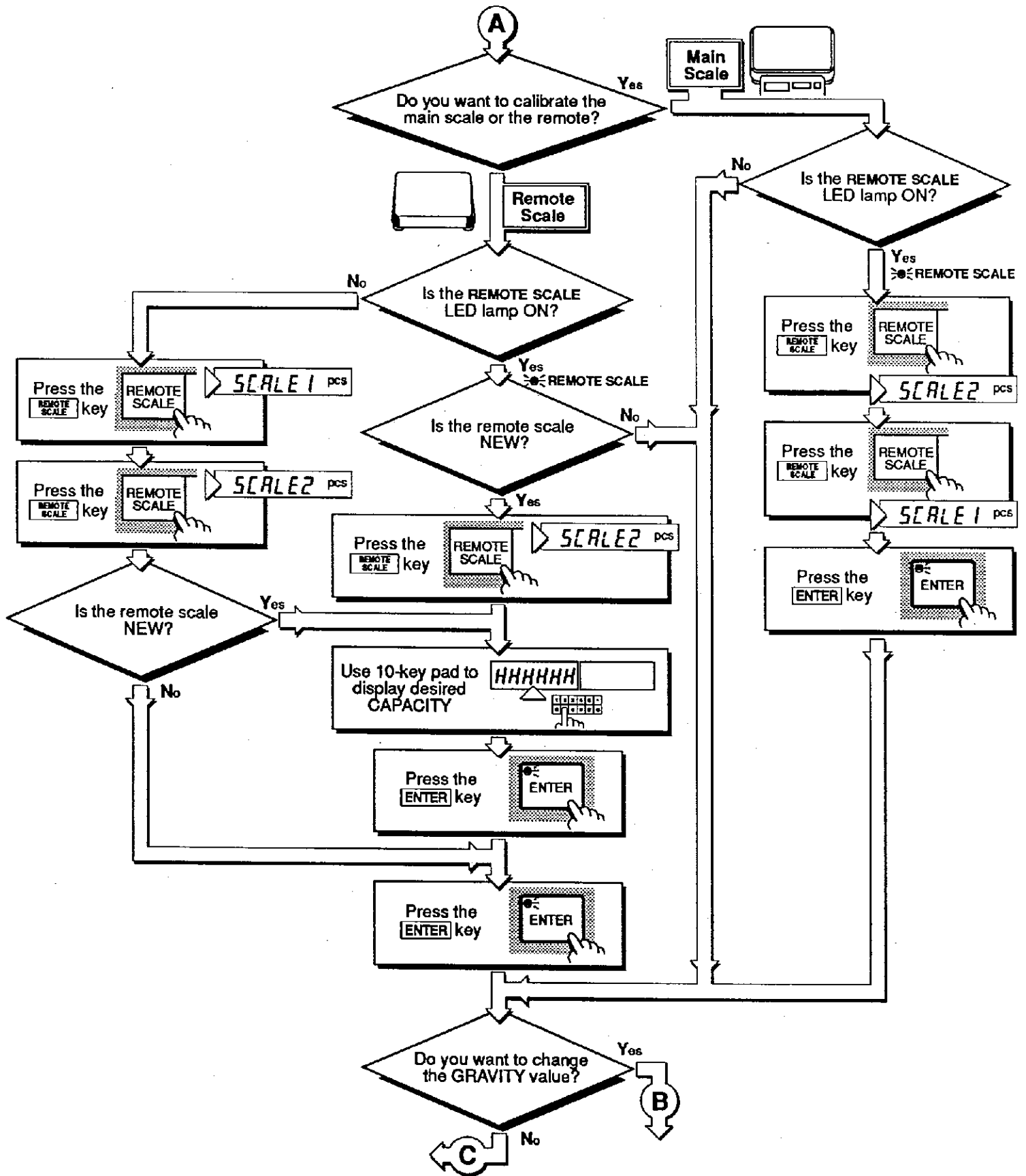

The value of Gravity Flowchart



There is additional information concerning calibration and gravity compensation on the pages following.

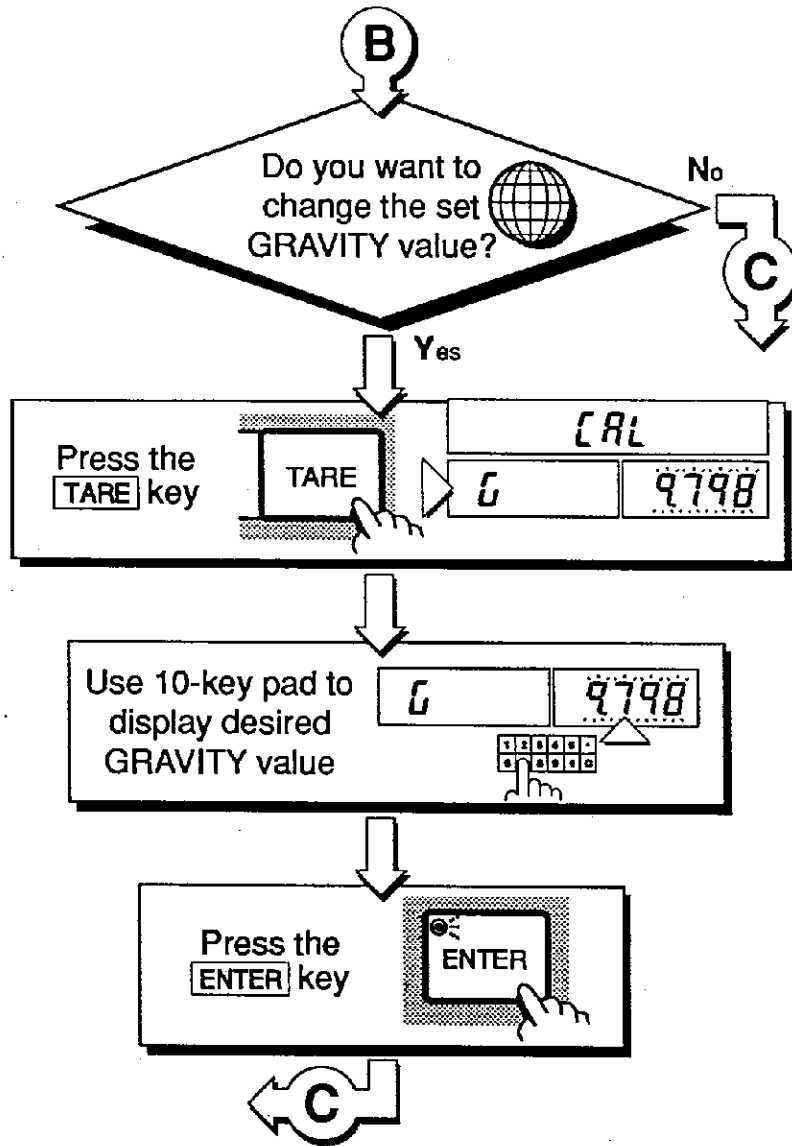



Additional Calibration & Gravity info.



Gravity Compensation



This additional information is intended for those users that are working with gravity variations, such as scale shipment over a long distance after calibration. It is solely for this use (when the FC scale is to be transported to a different geographical area), and it is not intended, nor needed for local or on-sight calibration. In other words: *Don't worry about it unless you need it!*



As stated earlier, calibration of the FC is required when it is initially installed, if it is moved often, or if it is moved a substantial distance. Gravity compensation can be necessary because the weight of a mass in one location is not necessarily the same in another location. "Weight" equals mass times acceleration due to Earth's field of gravity. The internationally adopted value for gravitational acceleration is 9.80665 m/s^2 (32.174 ft/s^2) in a vacuum. However, this varies by about ± 0.3 percent depending on how far you are from the Earth's center of mass. Mass distorts space in such a way that the gravitational power of attraction is inversely proportional to the square of the distance between material objects (if non-gravitational forces are ignored).

When we weigh a mass, we are trying to find its weight expressed in pounds or kilograms. Because "g" and other factors vary from location to location, we must calibrate the FC whenever we move it. Otherwise, a mass of 30kg might display 30.00kg in one location and 30.08kg in another (ie: "g" may have changed by +0.267%. $w=m \times g$). This would be an error, but it can be prevented by placing an accurate mass on the weighing device (say 30kg) and then telling the FC, in effect, "this is what 30kg weighs at this location so please display 30.00kg"..... this is calibration.

- It is best to set the "g" with the actual value of gravity, measured at the location. This can be found in reference tables for the country (or area), or sometimes from a physics laboratory at a local academic institution. Also, if you know the latitude and altitude, you can use the following formula:

Helmert's formula can be used to find the value of "g", the acceleration due to terrestrial gravity, for a given latitude and altitude:

$$g = 9.806\ 16 - 0.025\ 928 \cos 2\lambda + 0.000\ 069 \cos^2 2\lambda - 0.000\ 003\ 086H$$

"g" is in m/s^2 , " λ " means latitude and "H" is meters above sea level.

- Alternatively, please refer to the attached table for the value of "g" at various world wide locations or plot the end-user's position in terms of latitude and altitude on the enclosed graph (see pp. D-8-9).

Gravity values at various locations

Amsterdam	9.813	m/s ²	Manila	9.784	m/s ²
Athens	9.800	m/s ²	Melbourne	9.800	m/s ²
Auckland NZ	9.799	m/s ²	Mexico City	9.779	m/s ²
Bangkok	9.783	m/s ²	Milan	9.806	m/s ²
Birmingham	9.813	m/s ²	New York	9.802	m/s ²
Brussels	9.811	m/s ²	Oslo	9.819	m/s ²
Buenos Aires	9.797	m/s ²	Ottawa	9.806	m/s ²
Calcutta	9.788	m/s ²	Paris	9.809	m/s ²
Capetown	9.796	m/s ²	Rio de Janeiro	9.788	m/s ²
Chicago	9.803	m/s ²	Rome	9.803	m/s ²
Copenhagen	9.815	m/s ²	San Francisco	9.800	m/s ²
Cyprus	9.797	m/s ²	Singapore	9.781	m/s ²
Djakarta	9.781	m/s ²	Stockholm	9.818	m/s ²
Frankfurt	9.810	m/s ²	Sydney	9.797	m/s ²
Glasgow	9.816	m/s ²	Taichung	9.789	m/s ²
Havana	9.788	m/s ²	Taiwan	9.788	m/s ²
Helsinki	9.819	m/s ²	Taipei	9.790	m/s ²
Kuwait	9.793	m/s ²	Tokyo	9.798	m/s ²
Lisbon	9.801	m/s ²	Vancouver, BC	9.809	m/s ²
London (Greenwich)	9.812	m/s ²	Washington DC	9.801	m/s ²
Los Angeles	9.796	m/s ²	Wellington NZ	9.803	m/s ²
Madrid	9.800	m/s ²	Zurich	9.807	m/s ²

Acceleration due to Gravity table

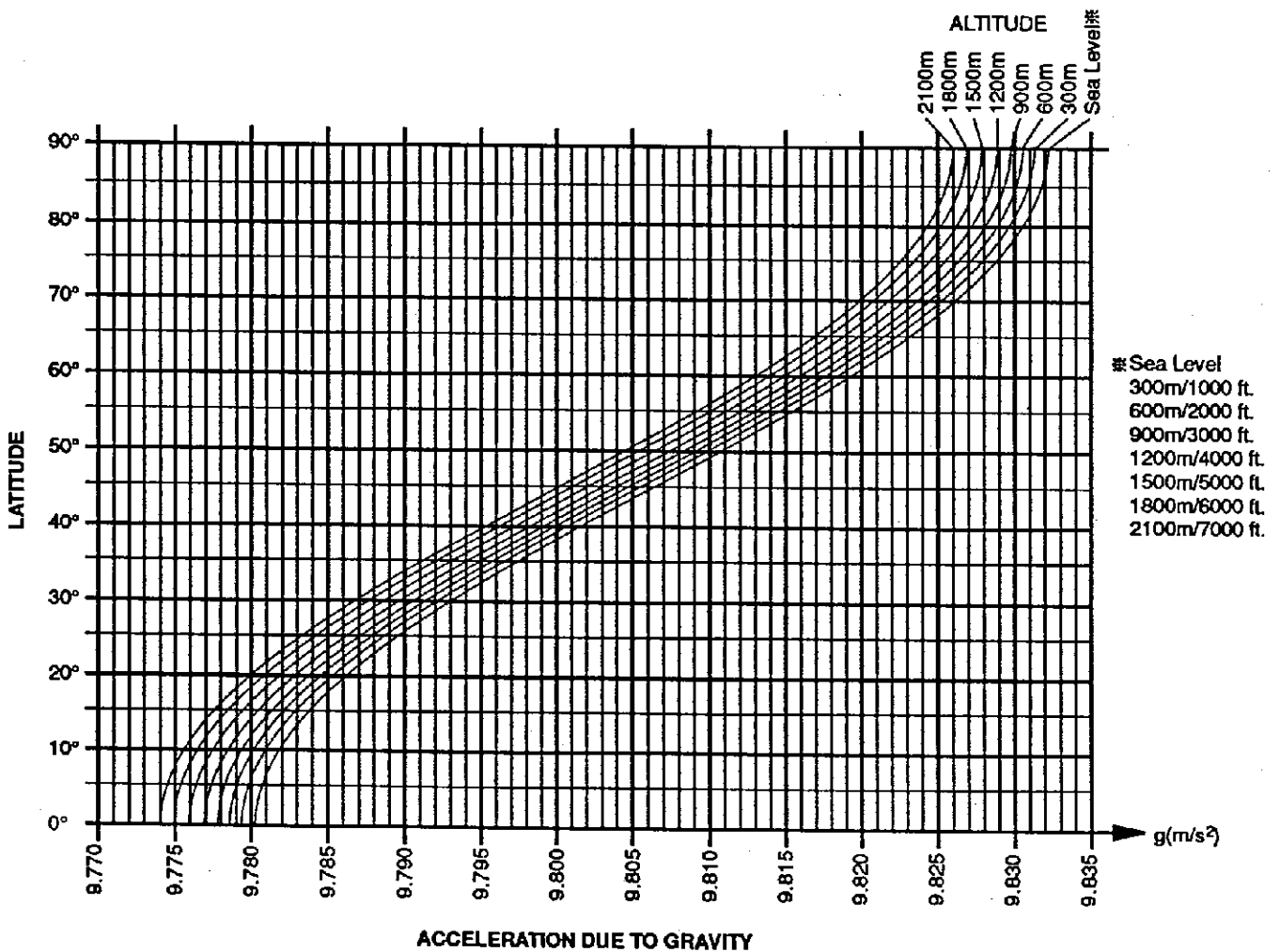



World Map

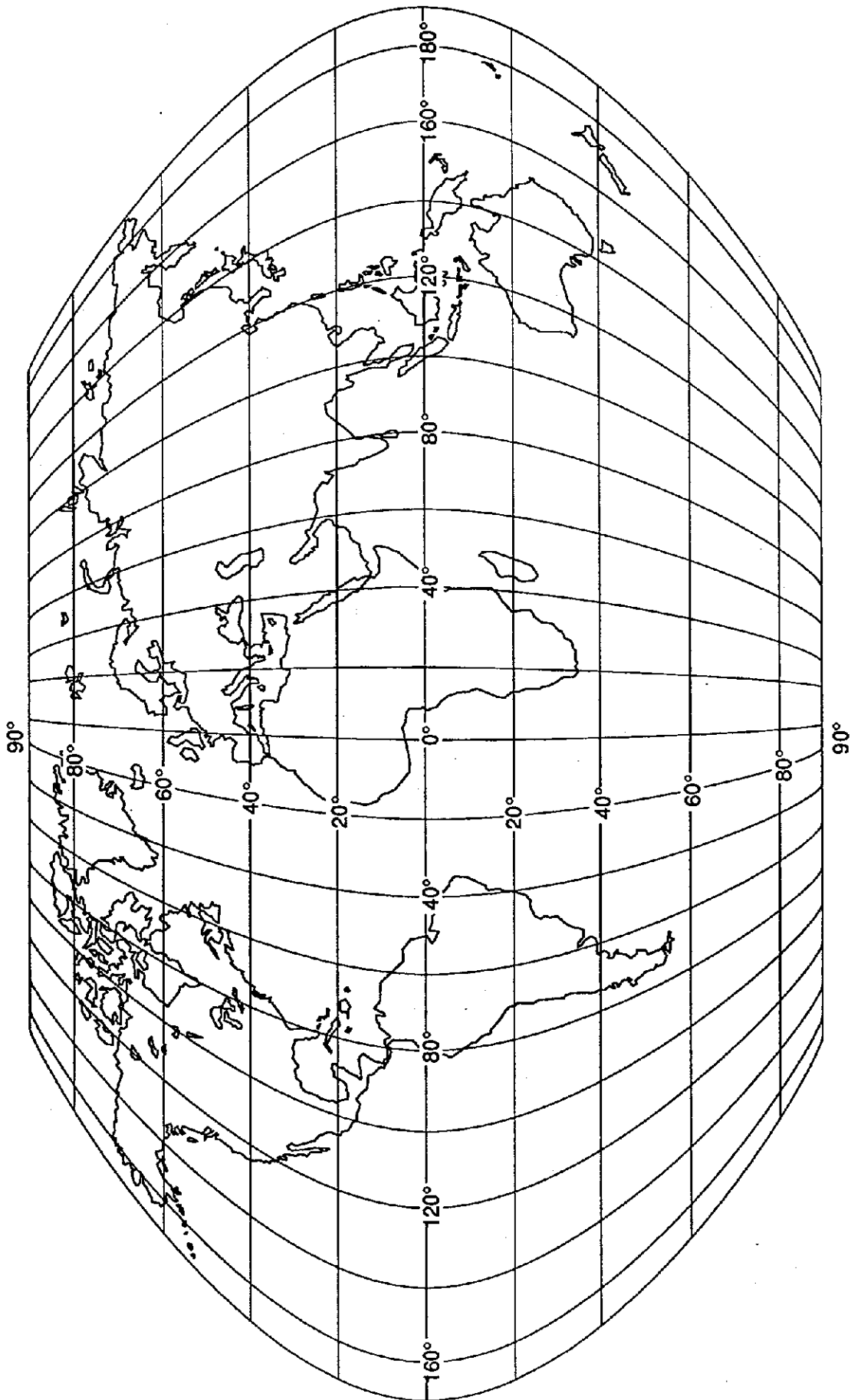



Memoranda



We hope that you have found this Instruction Manual useful and informative. If you have any suggestions for product improvement, found an error in this manual, or if you would like more information concerning this product, please don't hesitate to contact your nearest A&D office, or:

A&D Company, Limited

Shintaiso Bldg., No. 5-1052 / 2-10-7 Dogenzaka / Shibuya-ku, Tokyo 150 Japan
TEL: (03) 476-4741 FAX: (03) 462-1903 Telex: 02422816AANDDJ

A&D Engineering, INC.

1555 McCandless Drive / Milpitas, CA 95035 U.S.A.
TEL: (408) 263-5333 FAX: (408) 263-0119

A&D Instruments GmbH

Lyoner Straße 36, D-6000 Frankfurt/Main 71, West Germany
TEL: (069) 666-7006 FAX: (069) 666-6831

A&D Mercury PTY. LTD.

32 Dew Street, Thebarton, South Australia 5031 Australia
TEL: (08) 352-3033 FAX: (08) 352-7409



Index

Displays

"Add" Display, B-2
"id 000" Display, 1-10, 2-7, 4-4
Start-up Display, 1-6

A

ACAI:
 (brief intro), 1-8
 ACAI Notes C-2
 Automatic Operation C-3
 Manual Operation C-4
 with ID or Digital Input C-5
Adding Using the M+ Key, 5-2
Appendix A, Center of Zero, A-1
Appendix B, 'Add' Display, B-1
Appendix C, ACAI Counting, B-1
Appendix D, Calibration, D-1
Automatic Last Unit Weight Used, 1-10
Automatic M+ Accumulation Mode, 1-10

B

Bar Code Reader, 8-2
Basic Operations, 2-1
Best Conditions for Weighing, 1-7

C

Calibration:
 About, D-2
 Calibration (brief intro), 1-7
 Flowcharts, D-5-7
 Gravity Compensation Function, D-8
 Procedure, D-3
Clearing:
 A Memorized Unit Weight, 4-3
 the M+ Total, 5-4
Comparator Function:
 Section, 6-1, 6-2
 To Set, 6-2
Computer Connection, 10-8
Counting:
 by ID, 2-5
 by Keyboard, 2-6
 by Sample, 2-3
 by User Set Sample Size, 2-5
 How the Scale Counts, 1-7
 Simplified Operation, 2-3
 To Start, 2-2

D

Display Arm Option OP-04, 11-1
Display Pod Extension Cable Opt. OP-08, 14-3
Display Pod Wall Mounting Kit Opt. OP-07, 14-2

E

Entering a Tare Weight, 3-2

F

5, 25, 50 or 100 Sample Size, 2-4
FCC Rules, 1-3
F-Function Parameters:
 Changing (diagram), 7-6
 F- 1 Operations, 7-7
 F- 2 ACAI Oper. & Min. Unit Weight, 7-9
 F- 3 M+ Accumulation Function, 7-10
 F- 4 Environment and Beeper, 7-11
 F- 5 Comparator, 7-12
 F- 6 Data Output, 7-13
 F- 7 External Control Signal Input, 7-14
 F- 8 Weighing Unit, 7-14
 F-Function Parameters (brief intro), 1-8
 Listed (detailed), 7-7
 Overview (listing), 7-4
 To Change or View, 7-2

G

Gravity Compensation Function:
 Explained, D-8
 Table, D-9
 Gravity values, D-9

H

How the Scale Counts, 1-7

I

ID 000, 1-10, 2-7
ID's:
 Store Unit Weight, 4-1
 Store Unit Weigh & Tare, 4-4
 Clearing A Memorized Unit Weight, 4-3
Introduction Section, 1-5

K

Keys:
 Front Panel Overview 1-11
 Reset Key (note), 2-2
 Simple Operation Keys, 1-9
 Unit Weight By, 1-10
 Using the Tare key, 3-2
kg or lb Weighing Units (USA only), 1-9

L

lb or kg Weighing Units (USA only), 1-9
Load Cell:
 Capacity and Resolution, 12-5
 Connection, 12-3
 Connector, 12-4
 Input Sensitivity, 12-4
 Remote Scale kg / lb relationship, 12-6

M

M+ Key, Using 5-2
M+ Memory Function:
 (introduction), 5-2
 Adding Using, 5-2
 Clearing Total, 5-4
 Erase Last, 5-3
 Automatic, 5-3
M+ TOTAL:
 Clearing, 5-4
 Viewing, 5-4

N

NiCd Battery OP-02, 9-1-3

O

Operating Mode:
 Simple Operations Mode, 1-9
 Simplified Operation, 2-3
 Standby and Operating Mode, 1-8
Options:
 OP-01 Bar Code Reader, 8-1
 OP-02 NiCd Battery, 9-1
 OP-03 Serial Interface, 10-1
 OP-04 Display Arm, 11-2
 OP-05 Remote Scale Connector, 12-2
 OP-07 Wall Mount, 14-2
 OP-08 Built-In Printer, 14-3

P

Printer:
 AD-8117, 10-5
 AD-8117A, 10-6

R

Remote Scale Connector Option OP-05
 (section), 12-1
 Installation, 12-2
 Load Cell Connection, 12-3
 Scale Connection, 12-3
 Specifications, 12-4
Reset Key (note), 2-2

S

Sample Size:
 5, 25, 50 or 100, 2-4
 User Set, 2-5
Self-Check, 1-6
Serial Interface (OP-03):
 (section), 10-1
 Circuit Diagram, 10-1
 To Printer AD-8117, 10-5
 To Printer AD-8117A, 10-6
Setting Up Your Scale, 1-6
Simple Operations Mode, 1-9
Simplified Operation, 2-3
Standby Mode, 1-8
Store Unit Weight, 4-1

T

Tare Memorized, Unit Weight &, 4-4
Tare, To Clear, 3-4
Tare, Using (Section), 3-1
To Start Counting, 2-2

U

Unit Weight:
 By (keys): 1-10, 2-2
 By A Sample, 2-3
 By ID. Number, 2-6
 By Keyboard, 2-6
 Clearing A Memorized, 4-3
 Store Unit Weight, 4-1, 4-2
 Unit Weight (note) 1-7
Unit Weight & Tare Memorized, 4-4
Unit Weight Used, Automatic Last, 1-10
User Set Sample Size, 2-5
Using the KEYBOARD TARE Key, 3-3
Using the M+ Key, 5-2
Using the M+ Memory, 5-1
Using the TARE Key, 3-2

V

Viewing:
 the M+ Total, 5-4
Voltage Requirements, 1-6

W

Wall Mounting Kit (Option OP-07), 14-2

Weighing Units, kg or lb, 1-9
World map, D-10