

INSTRUCTION MANUAL

AD-8114



Mercury Weighing and Control Systems Pty. Ltd.
32 Dew Street, Thebarton, South Australia 5031. Telephone 352 3033
Telex AA89016 (MERSCA)

I. General

AD-8114 series are digital printers which receive data in BCD form from digital panel meters, digital voltmeters, digital thermometers and digital weighing indicators and print out data in numeric form.

AD-8114 series are available in four versions to suit the various applications.

Version	A	B	C	D
DATA	5 digits	7	16	6
DECIMAL POINT	1	1	§	1
I.D. CODE	3	6	§	2
UNIT	2	2	2	2
POLARITY	1	1	§	1

§such functions can be printed by decreasing the available DATA digits by a corresponding amount.

AD-8114 can be divided into five main functions as below.

- (A) Data Input
- (B) Printout Format
- (C) Printout Mode
- (D) Printout Control
- (E) Logic Setting

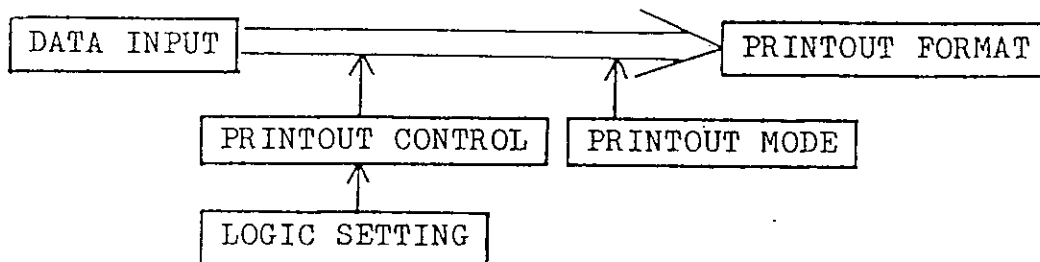

II. Operation

A. Setting Up

(1) Power and Ground

Connect the grounding wire of the power supply cable or the GND terminal on the rear panel to ground. Power should be the specified AC voltage $\pm 10\%$, 50Hz/60Hz.

(2) Put on the paper plate as shown below. This paper plate is to hold print paper.

AD-8114

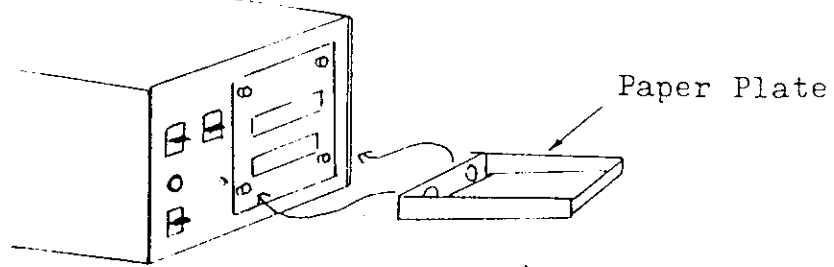

- (3) Put power switch on, and put MANUAL/EXT. switch to MANUAL.
Insert print paper to the slot of the printer indicated by Arrow ↑ as far as possible. Push FEED switch until the print paper-end appears from the Paper Outlet of the Printer.

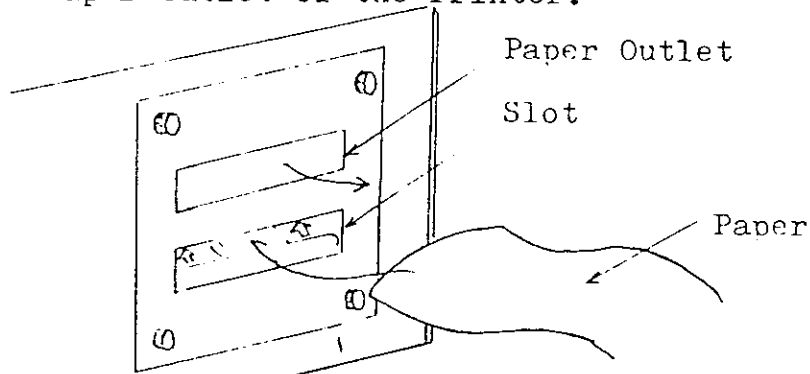

- (4) Connect the Data Input Cable A and B to the Terminals INPUT A and INPUT B of AD-8114. The Data Input Cables must be connected properly and the connectors must be specified ones.

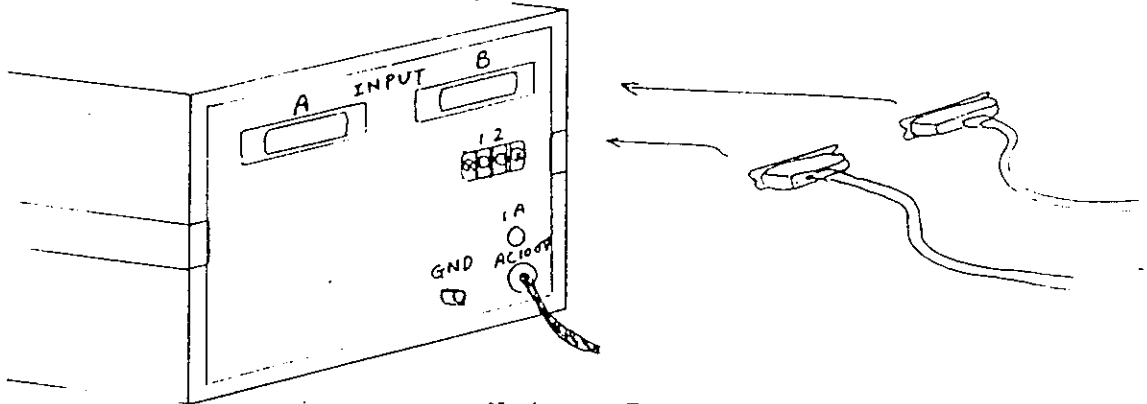

Note : Input B is not used for Version A and D.

- (5) Select MANUAL/EXT switch.
When this switch is on MANUAL, by pressing FEED/PRINT switch to PRINT side data is printed once. When this switch is on EXTERNAL, data is printed only when PRINT COMMAND signal is fed by the external instrument through the Input Cable A.

B. Notes

- (1) Pin connections of Input Cable A and B should be referred to DATA INPUT A and B in this manual.
- (2) Printout modes such as print letter color between black and red, print letter direction, paper feed logic level and print command logic level can be set by Logic Switches. Refer to Logic Switches

in this manual.

- (3) When READY/ALARM lamp is on, print comand either by MANUAL switch or external PRINT COMAND is accepted.

When this lamp is off, the printer is being activated and does not receive any more Print Comand.

When this lamp is flashing, this means the printer is mal-functioning. The printer returns to normal operation by pushing FEED switch. Otherwise, the printer is out of order.

III. Panel Description

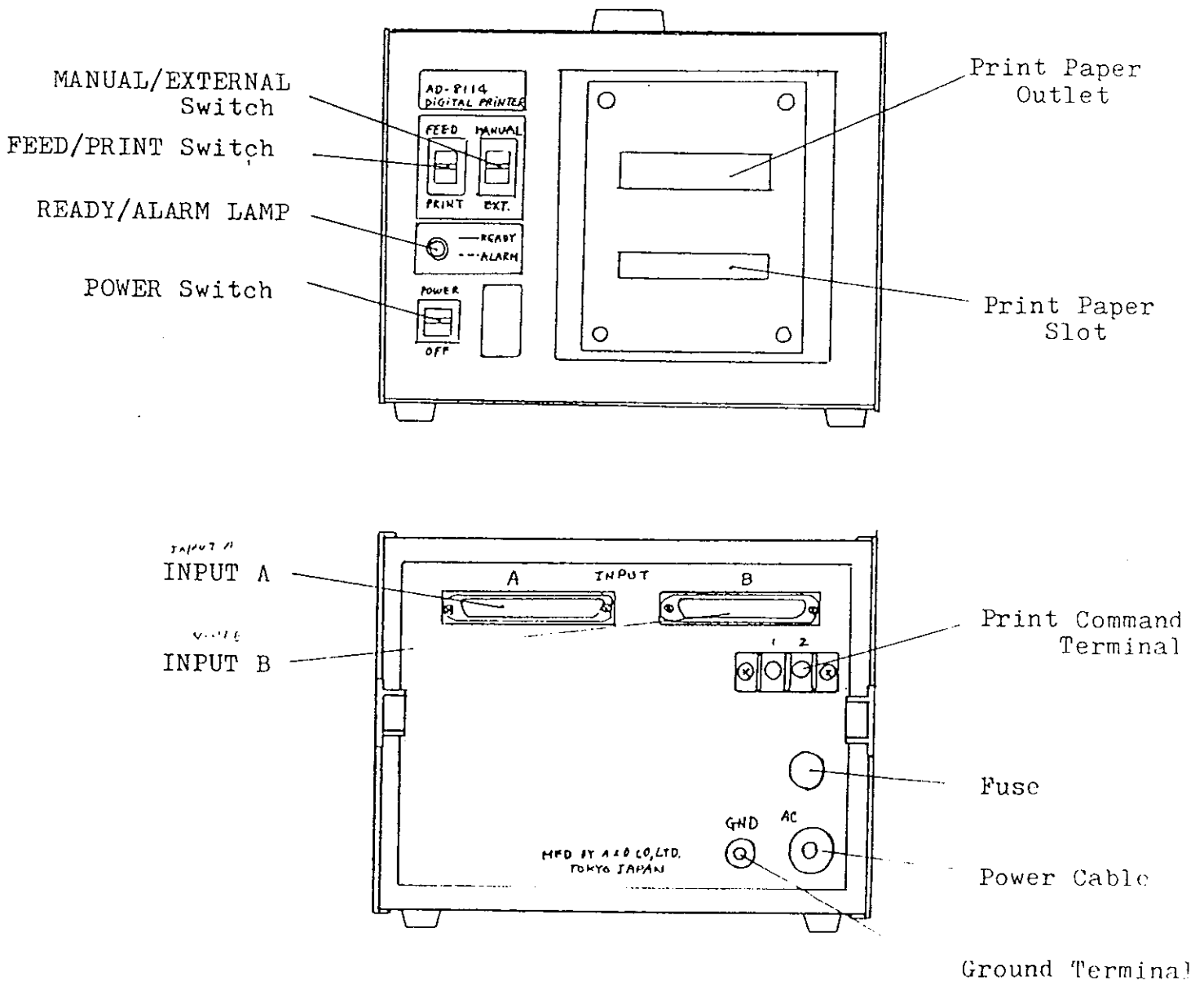

IV Printout Format

Font : I.D. Code, Data, Polarity 5 x 7 dots
 Unit A, B 8 x 7 dots

Printout example

Decimal Point

Column	18	17	16	15	14	13	12	11	10	9	8	7	6	5	4	3	2	1
AD-8111A			I.D. Code	1	2	3		+	9	.	9	9	9	9	9	m	V	
AD-8111B	1	2	3	4	5	6		+	9	9	9	.	9	9	9	9	m	V
AD-8111C	1	2	3	4	5	6	7	8	9	0	1	2	3	4	5	6	m	V
AD-8111D			I.D. Code	1	2			+	9	9	.	9	9	9	9	m	V	

Polarity
Unit B
Unit A

V. Data Input Pin Designation

(1) Data Input A

Pin No.	VERSION				Pin No.	VERSION			
	A	B	C	D		A	B	C	D
1		Logic Common			26	1x10 ¹	1x10 ⁶	1x10 ⁶	1x10 ⁰
2		1 x 10 ⁰			27	2 "	2 "	2 "	2 "
3		2 "			28	4 "	4 "	4 "	4 "
4		4 "			29	8 "	8 "	8 "	8 "
5		8 "			30	1x10 ²	10 ⁵	1x10 ⁷	1x10 ¹
6		1 x 10 ¹			31	2 "	10 ⁶	2 "	2 "
7		2 "			32	4 "	10 ⁷	4 "	4 "
8		4 "			33	8 "	10 ⁸	8 "	8 "
9		8 "			34	1			
10		1 x 10 ²			35	2	A		
11		2 "			36	4			
12		4 "			37	8		Unit	
13		8 "			38	1			
14		1 x 10 ³			39	2	B		
15		2 "			40	4			
16		4 "			41	8			
17		8 "			42	Polarity Ind.		Polarity Ind.	
18		1 x 10 ⁴			43	10 ¹	Decimal Point	10 ¹	Decimal Point
19		2 "			44	10 ²		10 ²	
20		4 "			45	10 ³		10 ³	
21		8 "			46	10 ⁴		10 ⁴	
22	1x10 ⁰	I.D. CODE			47	Printout color : black/red Select			
23	2 "				48	Paper	Polarity	Paper	Polarity
24	4 "				49	Feed	Prohibit	Feed	Prohibit
25	8 "				50	Print Command			

(i) Print Output signal can be used as BUSY or PRINT END by Auxiliary Setting SW1 6

(2) Data Input B (Only applies to AD-8114B and AD-8114C versions)

Pin No.	VERSION		Pin No.	version		
	B	C		B	C	
1	Logic Common		26	/	1×10^{14} 2 " 4 " 8 " 1×10^{15} 2 " 4 " 8 "	
2	1×10^0	1×10^8	27			DATA
3	2 "	2 "	28			
4	4 "	4 "	29			
5	8 "	8 "	30			
6	1×10^1	1×10^9	31			
7	2 "	2 "	32			
8	4 "	4 "	33			
9	8 "	8 "	34			
10	1×10^2	1×10^{10}	35			
11	2 "	2 "	36			
12	4 "	4 "	37			
13	8 "	8 "	38			
14	1×10^3	1×10^{11}	39			
15	2 "	2 "	40			
16	4 "	4 "	41			
17	8 "	8 "	42			
18	1×10^4	1×10^{12}	43			
19	2 "	2 "	44			
20	4 "	4 "	45			
21	8 "	8 "	46			
22	1×10^5	1×10^{13}	47			
23	2 "	2 "	48			
24	4 "	4 "	49			
25	8 "	8 "	50			

Connector (F) : 57-40500 (Daiichi Denshi Kogyo)
 Connector (M) : 57-30500 (")

Logic Level : TTL Compatible
 Logic "1" +2.4V to +5.5V or open
 Logic "0" 0V to +P.8V or short-circuit to LOGIC COMMON

LOGIC COMMON is not connected to Case GND.

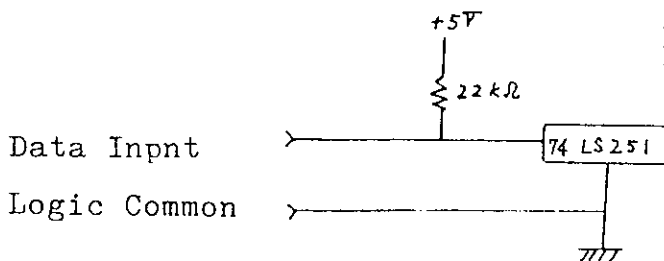

3. BCD Code Chart

3-1 Dode, Data, Unit A and Unit B

Code, Data, Unit A and Unit B are designated by the BCD code shown in Table 1.

I.D. CODE	PTINTOUT		BCD CODE				
	DATA	UNIT	8	4	2	1	
0	0	σ	%	0	0	0	0
1	1	M	∩	0	0	0	1
2	2	k	Ω	0	0	1	0
3	3	m	v	0	0	1	1
4	4	μ	A	0	1	0	0
5	5	P	S	0	1	0	1
6	6	n	F	0	1	1	0
7	7	μμ	Hz	0	1	1	1
8	8	L/	g	1	0	0	0
9	9	°C	H	1	0	0	1
A	+	r	Pm	1	0	1	0
B	-	t	W	1	0	1	1
C	.	(H)	dB	1	1	0	0
D	↑	space	space	1	1	0	1
E	↓	space	space	1	1	1	0
space	space	space	space	1	1	1	1

Version Pin Designation

I.D.
Code: A INPUT A
Nrs 22-33
B INPUT B
Nrs 2-25
D INPUT A
Nrs 26-33

Data: A INPUT A
Nrs 2-21
B INPUT A
Nrs 2-29
C INPUT A
Nrs 2-33
INPUT B
Nrs 2-33
D INPUT A
Nrs 2-25

Table 1

3-2 Polarity Indication, Polarity Inhibit and Printout Color

Polarity Indication, Polarity Inhibit and Printout Color are designated by BCD codes shown in Table 2.

Polarity Indication	Polarity Inhibit	Printout Color	BCD Code
-	Input A: Nr 48	Input A: Nr 47	
-	space	Black	0
+	+/-	Red	1

Table 2

3-3 Decimal Point

Decimal point can be set by BCD codes as shown in Table 3.

Decimal Point Position	10^8	10^7	10^6	10^5	10^4	10^3	10^2	10^1	Version	Pin Designation
None	1	1	1	1	1	1	1	1	A ...	INPUT A Nrs 43-46
10^1	1	1	1	1	1	1	1	0	B ...	INPUT A Nrs 43-46 Nrs 30-33
10^2	1	1	1	1	1	0	1	1	D ...	INPUT A Nrs 43-46
10^3	1	1	1	1	0	1	1	1		
10^4	1	1	1	1	1	1	1	1		
10^5	1	1	0	1	1	1	1	1		
10^6	1	1	1	1	1	1	1	1		
10^7	1	0	1	1	1	1	1	1		
None	0	1	1	1	1	1	1	1		

Table 3

Decimal point is printed on the data position corresponding to the above decimal point position.

VI Logic Setting

Various functions can be set by the built-in dip switches which can be reached by removing the case as shown in Fig.

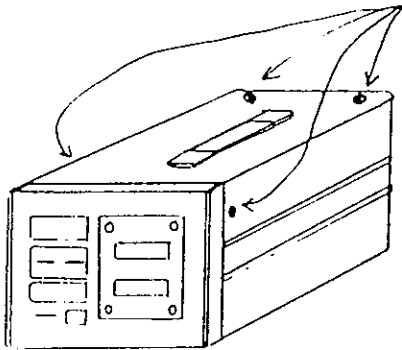

Unscrew four screws to remove the upper cover.

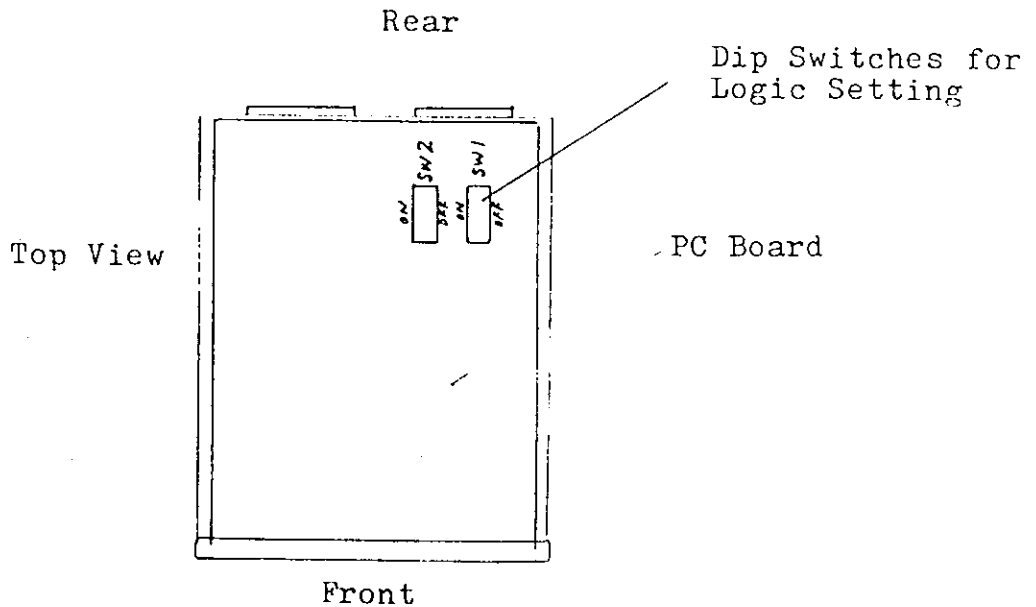

Functions shown in Table 3 can be set by dip switches, SW 1 and SW 2.

Switch	Functions	Note
SW1-1	PAPER FEED Logic level	When on, logic level is negative. When off, logic level is positive.
SW1-2	Printout Color Logic level	When on, logic level is negative When off, logic level is positive
SW1-3	I.D. Code Logic level	" "
SW1-4	Data Logic level	" "
SW1-5	Output signal Logic level	" "
SW1-6	Output signal Selection	When on, BUSY signal is output. When off, PRINTEND signal is output.
SW1-7	Printout signal Logic level	When on, logic level is negative. When off, logic level is positive
SW1-8	Polarity Printout	When on, polarity is not printed. When off, polarity is printed.
SW2-1	Paper Feed	When on, one line is fed. When off, no line is fed.
SW2-2	Paper Feed	When on, two lines are fed. When off, no line is fed. §When SW2-1 and SW2-2 are both on, three lines are fed.
SW2-3		
SW2-4	Printer CHECK	When on, CHECK program is activated. When off, the printer is in normal operation mode.
SW2-5	Print Mode	When on, the printer is activated once by PRINT switch for MANUAL/EXT. being on MANUAL. When on, the printer is synchronized to external Print Command signal for EXT. When off, the printer is activated continuously by pressing PRINT switch for MANUAL/EXT. being on MANUAL. When off, the printer is asynchronized to external Print Command signal for EXT.
SW2-6	Print Direction	When on, the print letter direction is normal. When off, the print letter direction is reversed.
SW2-7		Do not touch.
SW2-8		Do not touch.

Table 3

VII. Printout Control

- (1) Then MANUAL/EXT. switch is on MANUAL side, by pressing FEED/PRINT switch to the FEED side the paper is fed, and when this switch is on MANUAL side, by pressing the FEED/PRINT switch to the PRINT side the printer is activated. The printer can be activated by short-circuiting the terminals on the rear. The signal should be more 200ms long.
- (2) When PAPER FEED signal through Pin No. 48 of INPUT A is given, the paper is fed. (This applies only to AD-8114A and AD-811C.) The signal should be more than 200ms long.
- (3) When PRINT COMMAND signal through Pin No. 49 of INPUT A is given, the printer is activated. The signal should be more than 200ms long and less than 200ms long.

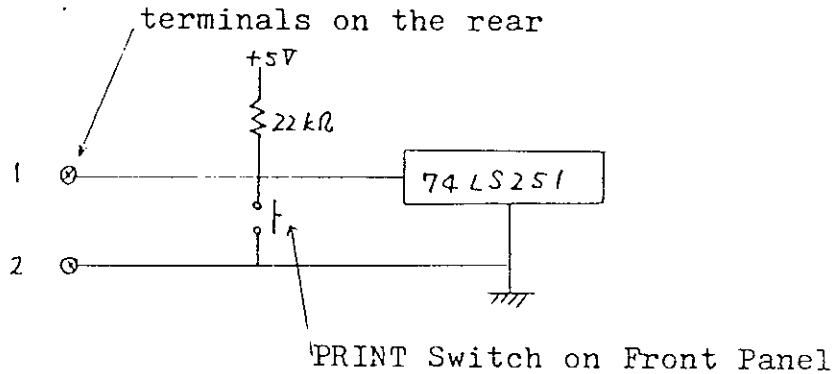

- (4) Printer output signal is given on Pin No. 50 of INPUT A.

Busy : 450ms
 Print End : 2ms
 Output signal level : TTL level

"1"	+2.4	+5.5V
"0"	0	+0.4V

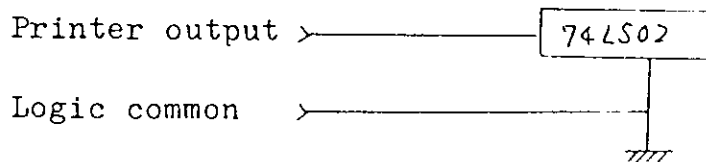

VIII. Printout Mode

Printout modes can be selected by MANUAL/EXT. switch and Logic Setting SW2-No.5 as below.

MANUAL/EXT. Selection	Logic Setting SW2-No.5	Printout Mode	PRINT Switch	Print Command INPUT A No.49
MANUAL	OFF	Continuously printed as PRINT switch is pushed.		
	ON	Printed once as PRINT switch is pushed.		
EXT.	OFF	Asynchronized to External Print Command.		Printed out as PRINT COMMAND is sent.
	ON	Synchronized to External Print-Command.	Print Command signal is acceptable when PRINT switch is pushed.	Printed out as PRINT COMMAND is sent when PRINT switch is on.

IX. Timing Chart

§ Paper Feed by MANUAL

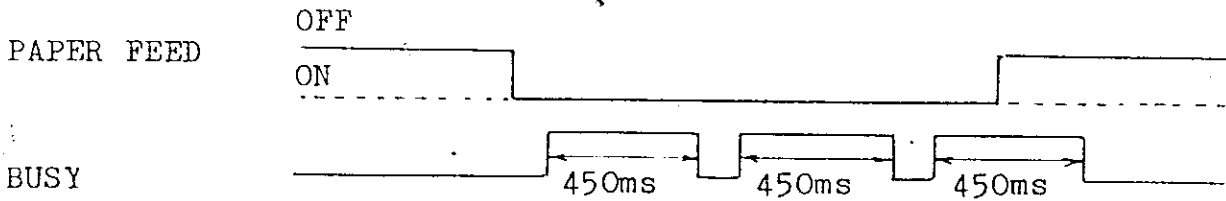

§ MANUAL ON and Logic Setting SW2-No. 5 OFF

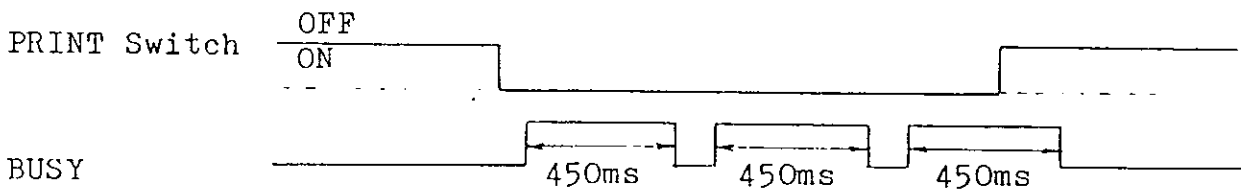

§ MANUAL ON and Logic Setting SW2-No. 5 ON

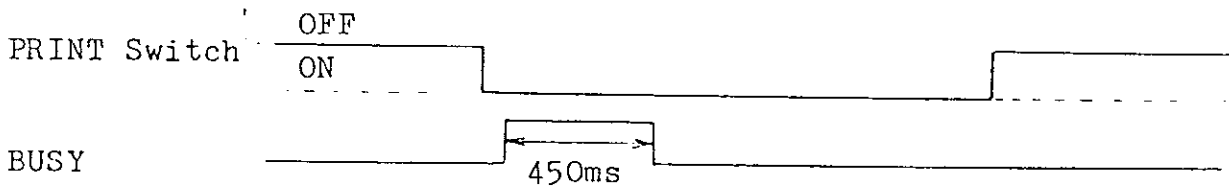

§ MANUAL OFF and Logic Setting SW2-No. 5 OFF

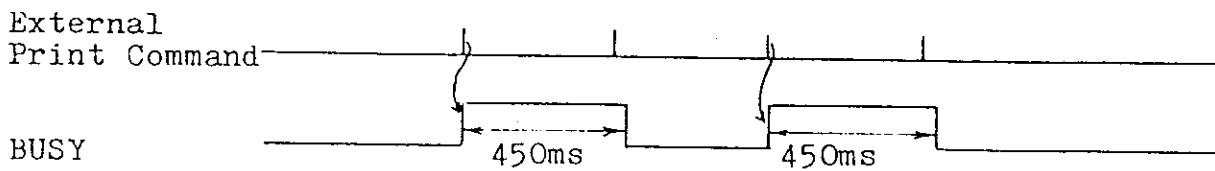

§ MANUAL OFF and Logic Setting SW2-No. 5 ON

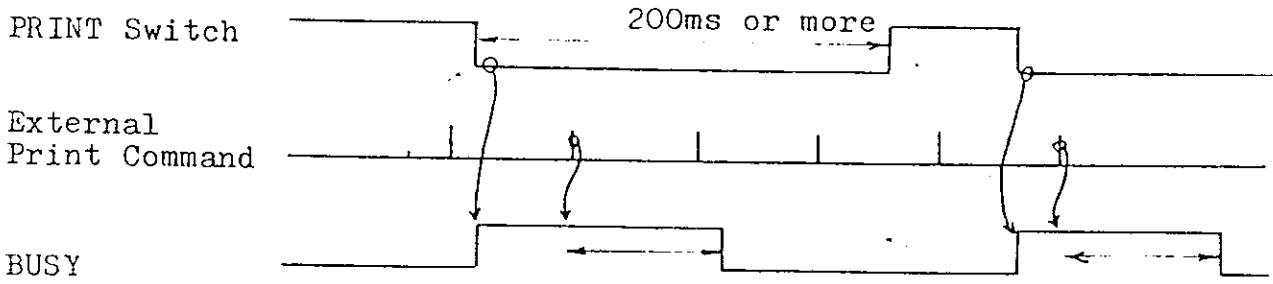

§ External Paper Feed Signal

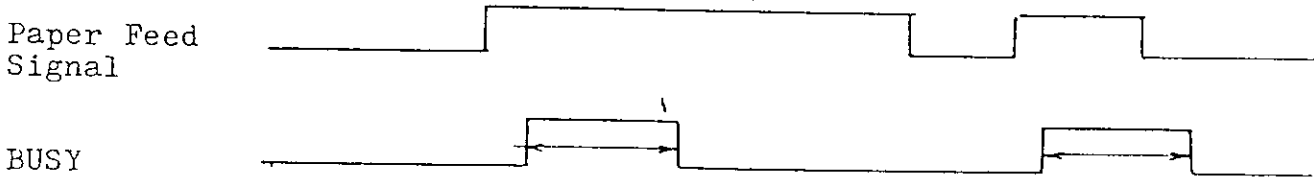

§ PRINTER ALARM

