

**AD-4713**

**MOISTURE BALANCE**

**INSTRUCTION MANUAL**

Instruction-AD-4713-v.1.d 94.08.17 OGA

Digital Moisture Balance

**AND**  
A&D Company, Limited



# Table of Contents

FCC Rules .....	page	iii
<b>Section A • Introduction</b> .....	page	A • 1
Welcome!.....	page	A • 2
Features .....	page	A • 2
<b>Specifications</b> .....	page	A • 3
Operator Selectable Settings.....	page	A • 3
<b>Unpacking Your Balance</b> .....	page	A • 4
Best Conditions for Weighing.....	page	A • 4
<b>Overview</b> .....	page	A • 5
<b>Setting Up Your Balance</b> .....	page	A • 6
<b>The Front Panel</b> .....	page	A • 8
Display .....	page	A • 8
Keyboard.....	page	A • 9
<b>Wireless Remote Keyboard</b> .....	page	A • 11
Wireless Remote Keyboard Key Functions.....	page	A • 12
<b>Section B • Basic Operation</b> .....	page	B • 1
<b>Setting Temperature and Time</b> .....	page	B • 2
Set Desired TEMP– Using Front Panel .....	page	B • 2
Set Desired TIME – Using Front Panel.....	page	B • 2
Set Desired TEMP– Using Remote Keyboard.....	page	B • 3
Set Desired TIME– Using Remote Keyboard.....	page	B • 3
<b>Moisture Measurement</b> .....	page	B • 4
Tare the Display, Load Sample, Start.....	page	B • 4
<b>Section C • Modes</b> .....	page	C • 1
<b>0.1% or 0.01% Displayed Mode</b> .....	page	C • 2
<b>Wet or Dry Basis Determination</b> .....	page	C • 3
<b>Measurement Modes</b> .....	page	C • 4
<b>Prediction Measurement Mode</b> .....	page	C • 6
Automatic Coefficients Setting .....	page	C • 7

<b>Manual Coefficient Setting</b> .....	page	C • 12
<b>Using the Coefficient Modes</b> .....	page	C • 15
<b>Printer Output</b> .....	page	C • 16
Date .....	page	C • 16
Sample Number.....	page	C • 16
Data Output .....	page	C • 17
Graphic Output Limits (SPAN).....	page	C • 17
Graphic Examples .....	page	C • 18

<b>Section D • Serial Interface</b> .....	page	D • 1
<b>Serial Interface</b> .....	page	D • 2
Specifications (Serial Interface).....	page	D • 2
Pin Connection.....	page	D • 2
Serial Interface Circuit Diagram.....	page	D • 3
Connection Precautions.....	page	D • 3
<b>Data Output Mode</b> .....	page	D • 4
To Set Data Output Mode .....	page	D • 4
<b>What a Computer Can Control</b> .....	page	D • 5
Conditions Settings.....	page	D • 5
Balance Functions .....	page	D • 5
<b>Serial Interface Commands</b> .....	page	D • 5
Temperature Setting H xxx.....	page	D • 5
Time Setting M xxx.....	page	D • 5
Base Selection.....	page	D • 5
Unit Selection.....	page	D • 6
<b>Output Fhh</b> .....	page	D • 6
Output Items.....	page	D • 6
Temperature Symbol Setting Ohh.....	page	D • 7
TARE ' T ' .....	page	D • 7
START/STOP ' S ' .....	page	D • 7
RESET ' R ' .....	page	D • 7
<b>Printout Examples</b> .....	page	D • 8



## FCC Rules

Please note that this equipment generates, uses and can radiate radio frequency energy. This equipment has been tested and has been found to comply with the limits of a Class A computing device pursuant to Subpart J of Part 15 of FCC rules. These rules are designed to provide reasonable protection against interference when equipment is operated in a commercial environment. If this unit is operated in a residential area it might cause some interference and under these circumstances the user would be required to take, at his own expense, whatever measures are necessary to eliminate the interference.

(FCC = Federal Communications Commission in the U.S.A.)

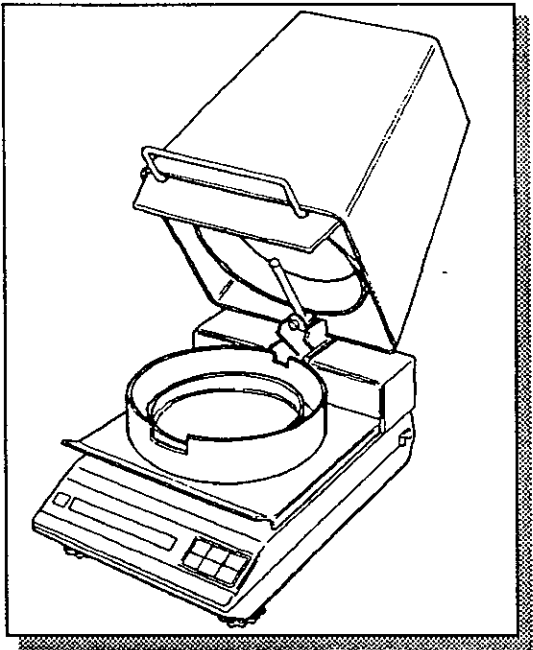

## AD-4713 • Section A

# Introduction



# Welcome!

Thank You for Your **AND** Purchase!

This is an *INSTRUCTION MANUAL* for the AD-4713 Moisture Balance. Every care has been taken during the manufacturing process of this moisture balance to ensure that it will perform accurately and reliably for many years. Electronic balances are in one sense extremely simple products, that is they are very easy to use. In another sense they are rather complex in that they are high technology products. This manual will try to tell you in simple language how this balance works and how to get the most out of it in terms of performance.

The AD-4713 Digital Moisture Balance offers fast and easy moisture percentage determination with a weighing resolution of 0.001g. Utilizing proven technology, the high-efficiency infrared heating or burning of the sample between 1 and 300 grams. Choose any temperature between 50°C and 250°C (122°F → -418°F).

The Digital Moisture Balance has four time setting modes to provide flexibility for the user. Input the minutes to be heated, or use an automatic process, to determine the moisture percentage of a sample.

The AD-4713 is designed for convenient routine testing on the production line or in the lab. The large LCD display shows temperature, time, and weight or moisture content. All balance functions can also be keyed in by a remote control unit which comes standard. An RS-232C Interface is provided standard for easy connection to an optional printer or computer.



## Features

- Moisture accuracy determination to 0.1%.
- No need to exactly measure sample weight — any weight between 1 and 300 grams (0.03 ~10.58 oz) is fine.
- High efficiency infrared lamp minimizes measurement error caused by uneven heating or burning of the sample.
- Sharp, easy-to-read LCD display.
- Set heating time by inputting minutes, or using Auto Stop, Predict Stop or Manual Stop modes.
- Easy-to-use—simply load a sample and press the **START** key.
- Non-volatile memory preserves temperature and time settings after the unit is turned off.
- RS-232C Interface comes standard for connection to an optional external printer (AD-8120), or to a computer.



## Specifications

Sample Weight:	1→300 grams
Measurement range:	0→100% (wet basis) 0→500% (dry basis) 0→100% (dry matter)
Moisture % Resolution:	0.01% or 0.1%
Weighing Resolution:	1 mg
Display Units:	Moisture (%), Weight (grams), Time (minutes) and Temperature (°C)
Accuracy:	0.1%(over 3g), ± 0.2% (1→3g)
Temperature Range:	50 to 250°C*
Drying time:	1 to 90 minutes, or continuous
Data Communication:	Serial RS-232C Interface for printer or computer
Power source:	Body: 100→240 VAC (50/60 Hz) Remote controller: DC 3V ("AA" x 2 pcs)
Dimensions:	Sample pan: 130mm diameter Body: 194 x 320 x 350mm Weight: 7.5kg

\* Operating environment may prevent control over 240°C.



## Operator Selectable Settings

*The Following modes and ranges can be set by the operator:*

Drying temperature:	50°C→250 °C*
Drying time:	1 to 90 minutes or continuous
Measurement Modes:	Time, automatic predict, or continuous
Moisture % format:	0.1% or 0.01%
Moisture % basis:	Wet or dry ; dry matter
Date:	Year, month, day
Sample number:	1 to 65535
Date output:	Graphics, initial data, final data, all data and serial output
Graphics printout ; range:	5, 10-100% (every 10%) 100-500% (every 100%)

\* Operating environment may prevent control over 240°C.



## Unpacking Your Balance

- Please unpack the balance carefully and keep the packing material if you are likely to want to transport the balance again in the future.
- In the carton you should find the AD-4713 Balance plus:

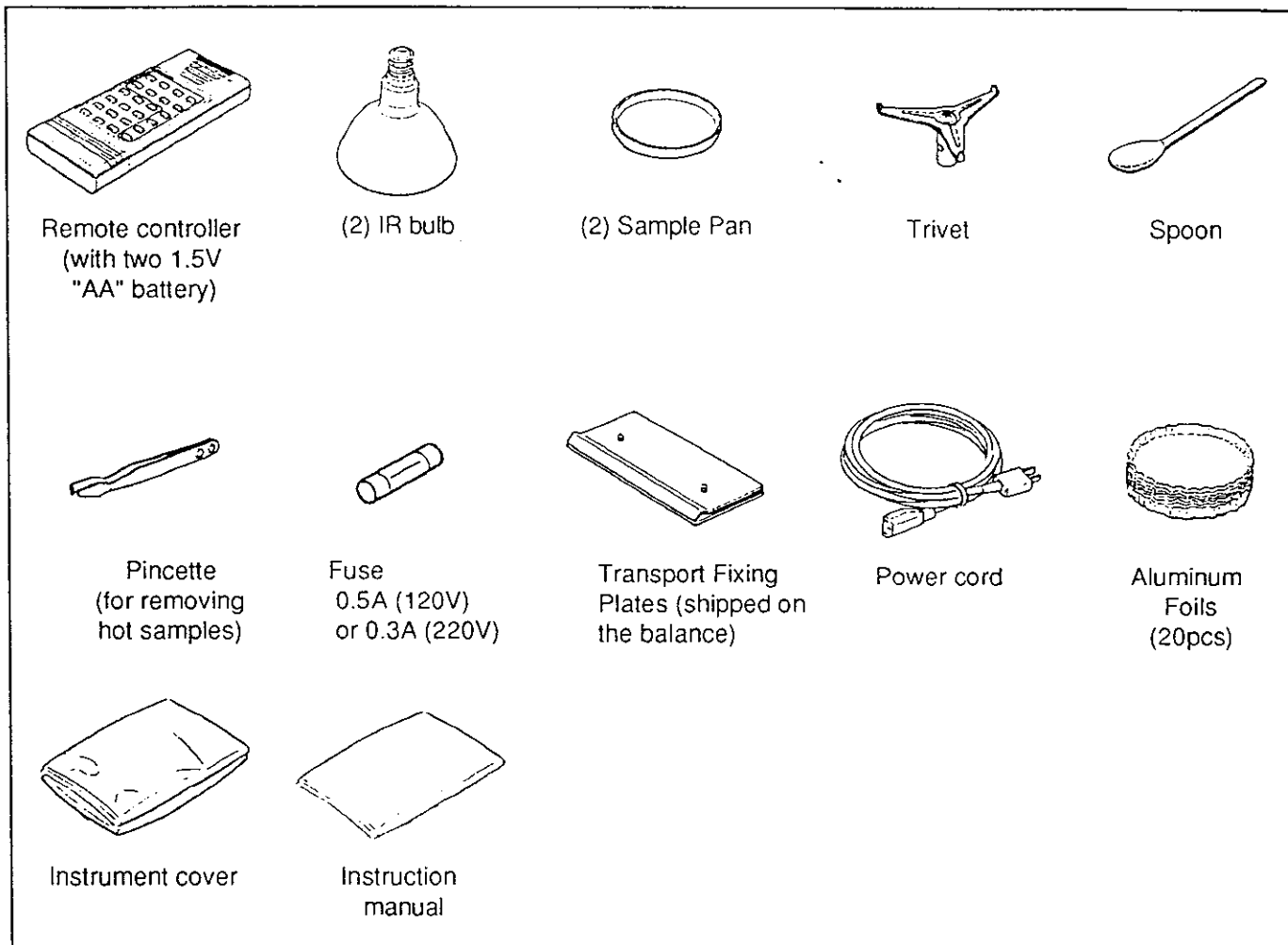

- ▶ Please see the OVERVIEW on the next page, and then go to SETTING UP YOUR BALANCE on the page after.



## Best Conditions for Weighing

- The Balance must be level (check the spirit level, see p. A•6).
- Best temperature is about 20°C/68°F at about 50% Relative Humidity.
- The weighing room should be kept clean and dry.
- The weighing table must be of a solid construction.
- Corners of rooms are best as they are less prone to vibrations.
- Don't install the balance near heaters or air conditioners.
- Don't install the balance in direct sunshine.
- Try to ensure a stable AC power supply.
- Keep equipment containing magnets away from the balance.
- Ground the balance when using an adaptor.





# Overview

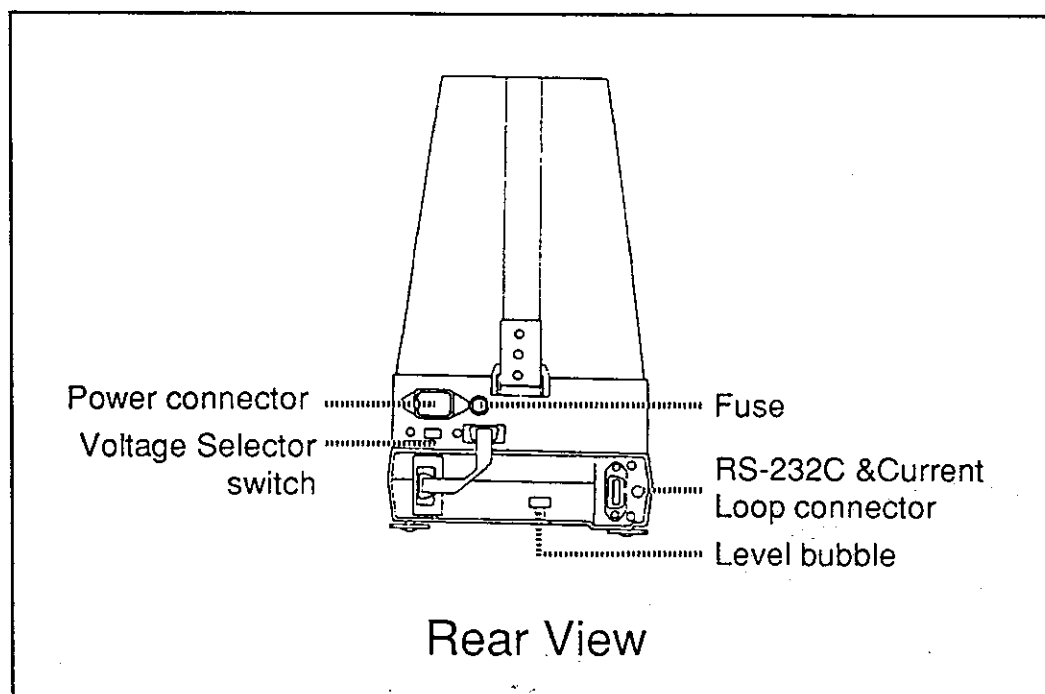
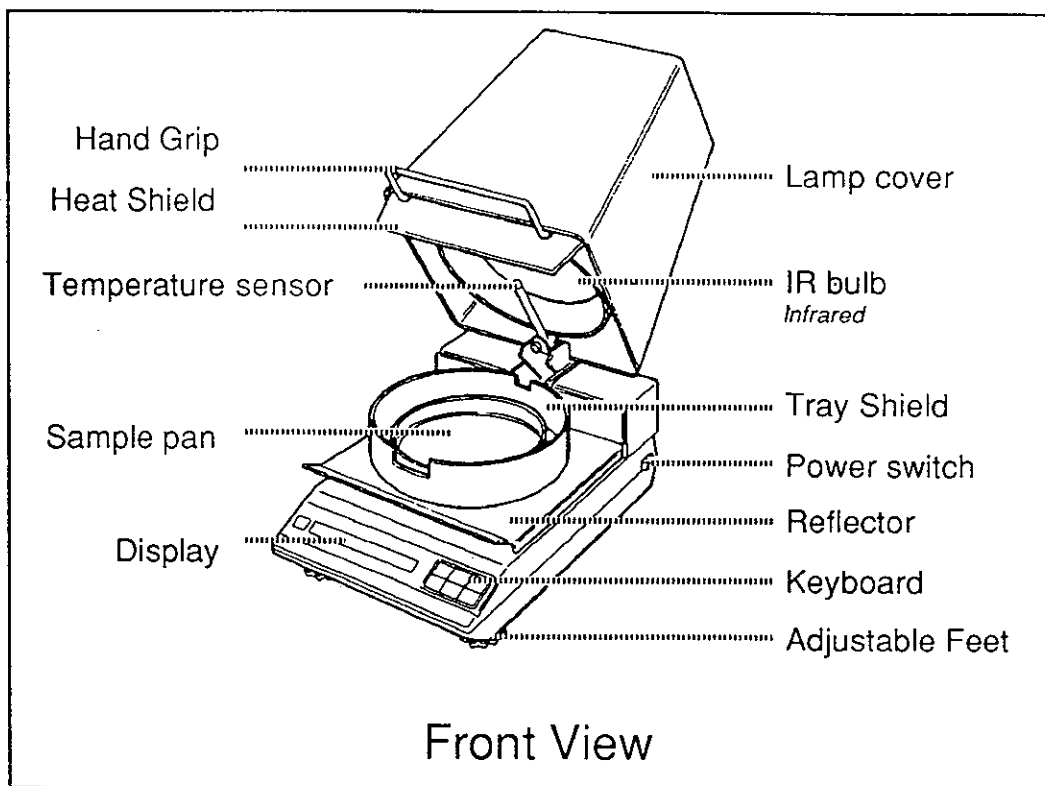



# Setting Up Your Balance

1 Select a weighing area that meets as many of the BEST CONDITIONS FOR WEIGHING on page A•4 as possible.

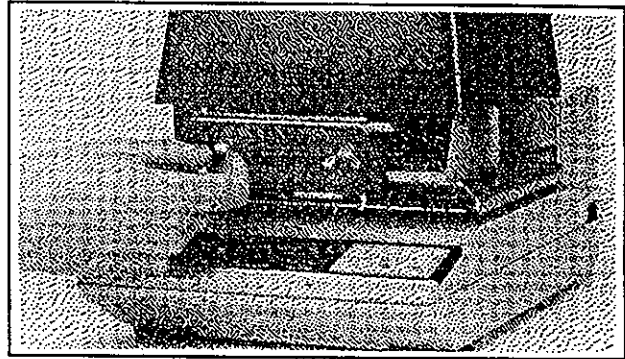

2 Remove the transport fixing plates by loosening the two shipping screws.

3 Level the balance by rotating the leveling feet until the bubble level (at the rear of the balance) shows level (bubble is the center of the small circle).

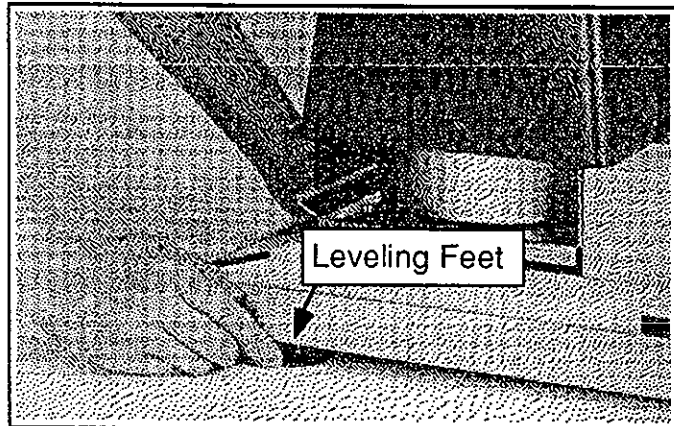
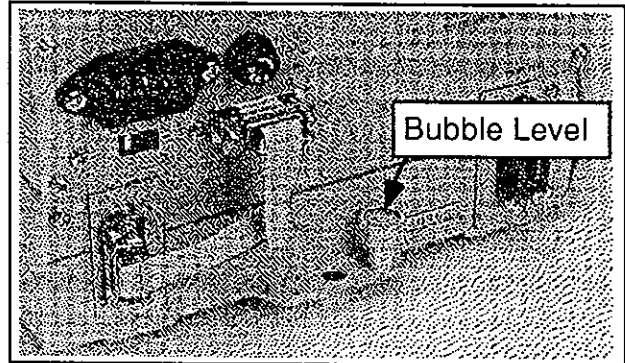

4 Install the IR Bulb.

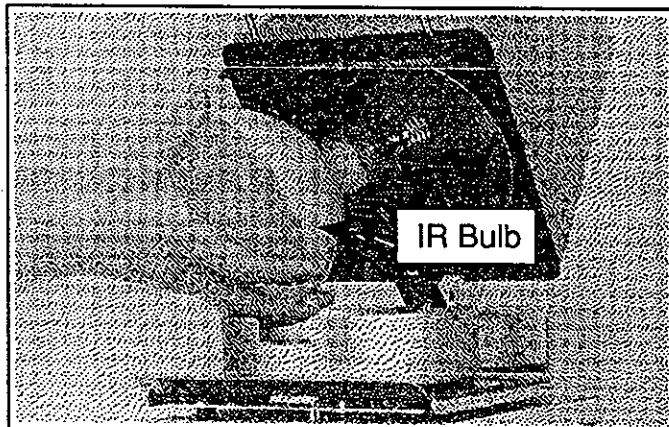

- 5 Position the tip of the temperature sensor in the center of the bulb, tighten the screw to hold it in place.

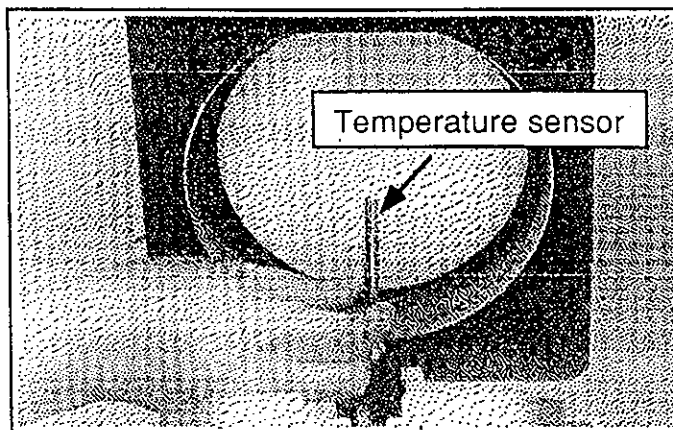

- 6 Make sure the Tray Shield is set so the three holes in the shield fit onto the three screws on the balance.

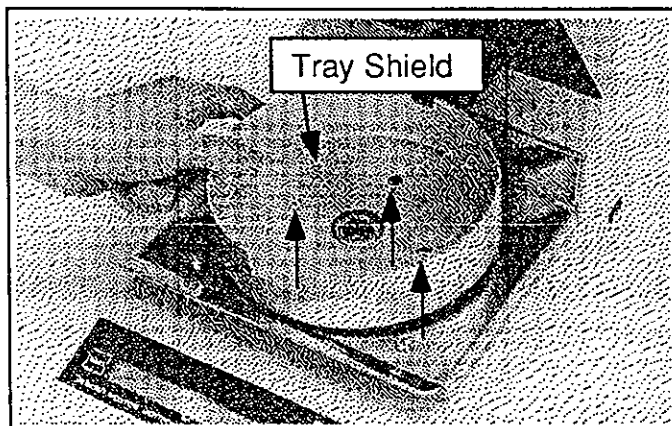

- 7 Place the Trivet as shown.

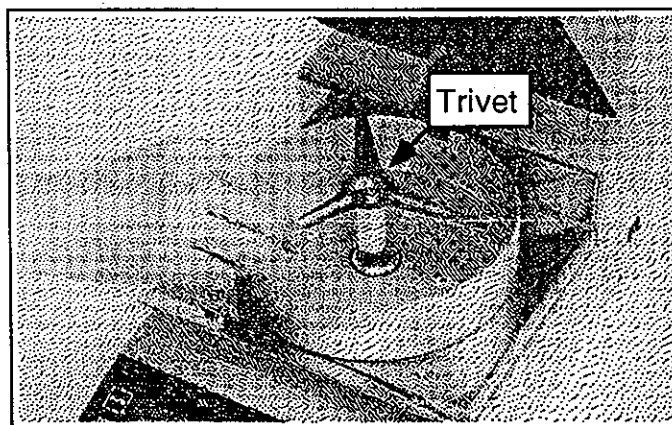

- 8 Use the Pincette to place the Sample Pan on the Trivet as shown.

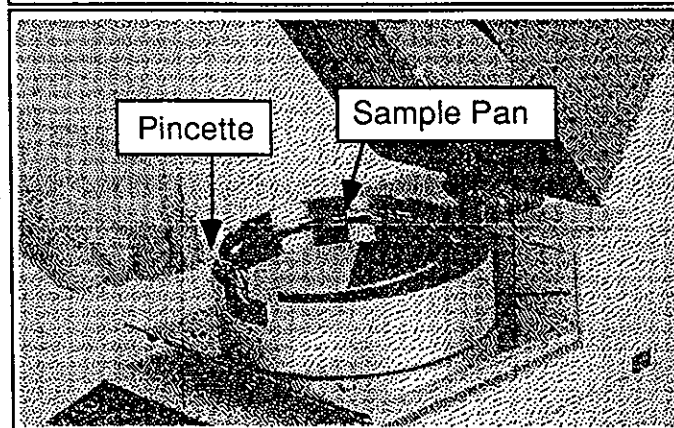

- 9 Connect the balance to power. The AC input requirements are 100 to 120 Volts, or, 220 to 240 Volts (50/60Hz) depending on the area in the world you are in. (if you are uncertain, please check the switch on the back). Connect the ground wire to earth if adaptor is used.



# The Front Panel

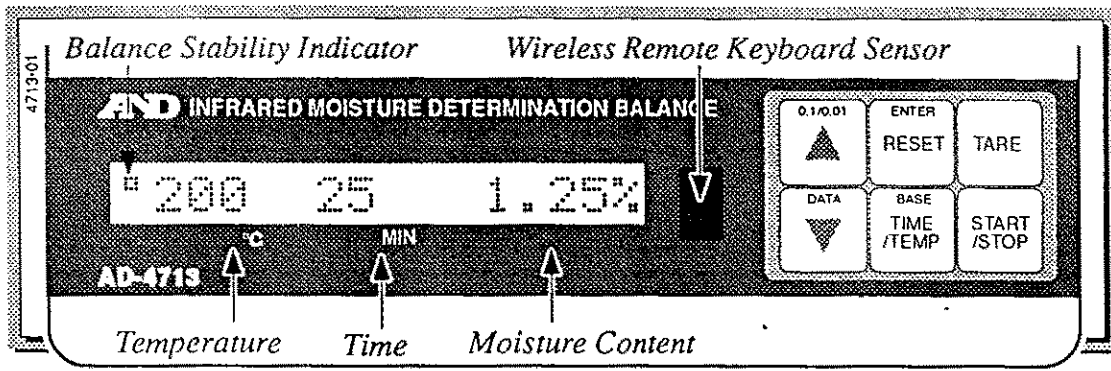

## Display

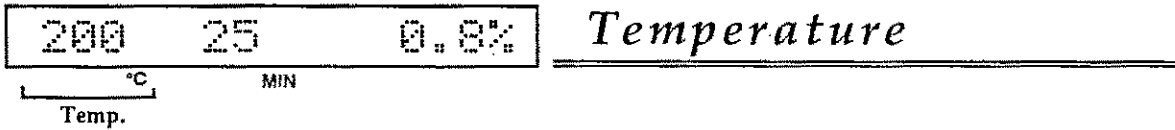

- The Temperature setting is at the far left of the display, shown in degrees Centigrade. The AD-4713 has a range from 50°C to 250°C.



- The set Drying Time is displayed to the right of the temperature. It can be set in one minute increments, 1 min. to 90 min (The "00" setting means that the heater is always ON and the AD-4713 is continuously measuring. The **STOP** key must be pressed to stop process).



- When you turn ON the AD-4713, and before you start the moisture determination procedure, the balance will be in a weighing mode - displaying samples on the weighing pan in grams.

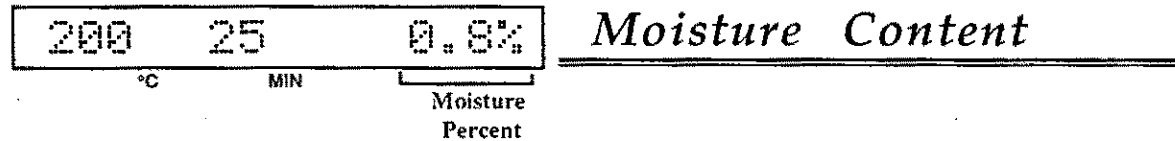

- Every 10 seconds during the moisture determination cycle the display will show the samples moisture content (%) to that point in the cycle. At the end of the cycle, the final moisture content will be displayed.

## Keyboard



### ▲ \ 0.1%/0.01% Key

- Increases the Temperature or Time displays. This key works when the cursor is flashing by either setting.
- It also sets the moisture indication, either 0.1% or 0.01%.



### Reset \ ENTER Key

- Resets the balance for the next measurement.
- Also for use in setting moisture basis, moisture indication and printing format.



### Tare Key

- Cancels non-measurement weight, such as weight of the sample foil or sample pan.



### ▼ \ DATA Key

- Decreases the Temperature or Time displays. This key works when the cursor is flashing by either setting.
- It also sets data output mode.



### TEMP/TIME \ BASE Key

- This key is used to move between the Temperature and Time settings for the moisture determination cycle. Press it, and a flashing cursor appears by the °C setting. Press it again and the cursor moves to the MIN setting.

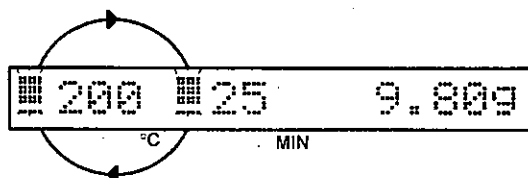

- Also sets the moisture basis (dry or wet).



## *Start/Stop Key*

---

- This key is used to START, or STOP the heating cycle. After the START key is pressed: the heating unit goes ON.

# Wireless Remote Keyboard

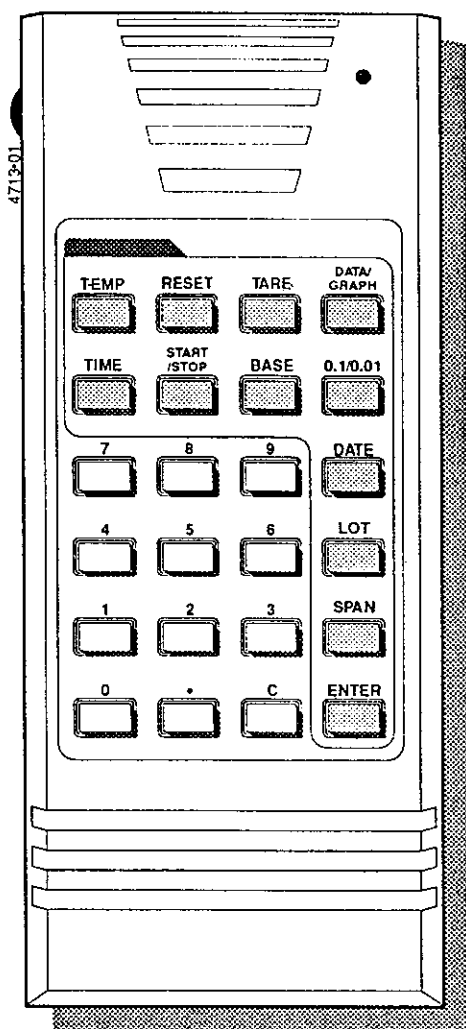

By using the Wireless Remote Keyboard, the AD-4713 can be controlled with a 3m, 60° operating range. You never have to touch the balance itself.

Since every balance feature can be controlled by the Remote Keyboard, and digital data can also be entered through the 10-key keys, you greatly simplify the more complicated balance functions.

⚠ When using the Wireless Remote Keyboard, remember that the balance sensor has a 3-meter, 60° operating range.

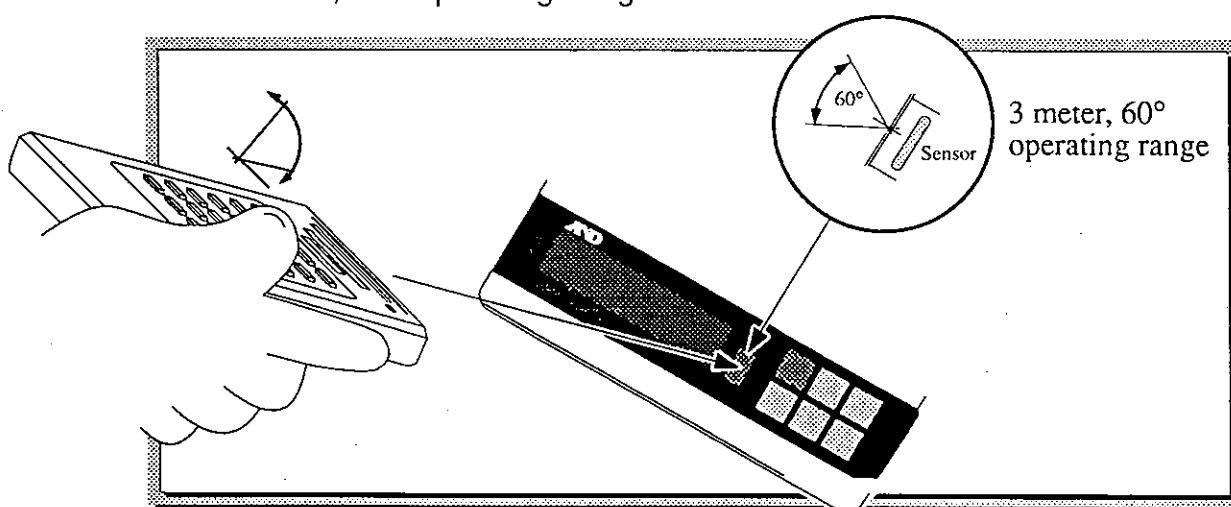

## Wireless Remote Keyboard Key Functions



- ▶ Press it, and a flashing cursor appears by the °C setting, to set the drying temperature.



- ▶ Resets the balance for the next measurement



- ▶ Cancels non-measurement weight, such as weight of the sample foil or sample pan.

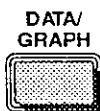

- ▶ Sets the data output.



- ▶ Press it, and a flashing cursor appears by the MIN setting, to set the drying time.



- ▶ Starts or stops measurement.



- ▶ Sets the moisture basis (dry or wet) (also used as +/- key in some setting modes).



- ▶ Sets the moisture indication (0.1% or 0.01%).



- ▶ Sets date on printout.



- ▶ Sets lot or sample number for printout.



- ▶ Sets upper limit of moisture percent when using graphics print mode.



- ▶ Enters keyed data into balance memory.



- ▶ Number keys.



- ▶ Decimal point.



- ▶ Clear key. Used to correct keyed entries.



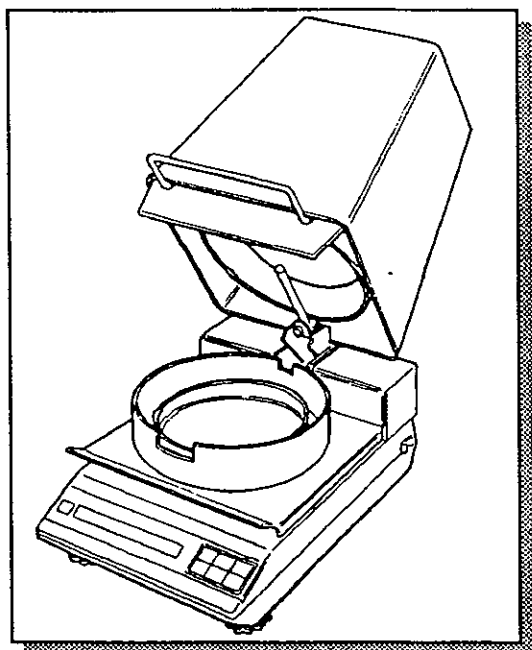

## AD-4713 • Section B

# Basic Operation

# Setting Temperature and Time



- ❑ Do not try to measure any material that is potentially combustible or flammable!
- ❑ Use only the handle on the Heating Unit Top to lift it. DO NOT TOUCH any part of the heating unit after it has been activated!
- ❑ Be sure to monitor the sample - DO NOT leave it unattended!

1 Turn the power switch ON.

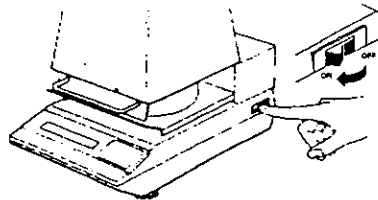

2 The display will show "BUSY" while the balance initializes.



3 After a few moments, the display will show the temperature, time, and weight from the last moisture determination.



## Set Desired TEMP- Using Front Panel

4 Press the **TEMP/TIME** key.

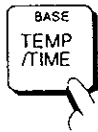

- A cursor will flash by the °C setting shown.

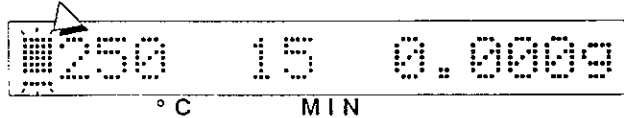

- You may change the temperature setting only while this cursor is flashing - if the setting is not changed within a few moments, the cursor will stop

5 Use the ▲ key to increase, or the ▼ key to decrease the displayed setting until you have reached your new setting.



- If you hold these keys down - after moving 10 digits, the change will speed up.



## Set Desired TIME - Using Front Panel

6 Press the **TEMP/TIME** key.





- A cursor will flash by the MIN setting shown.





7 Use the ▲ key  or the ▼ key  to increase, or decrease the displayed setting until you have reached your new setting. 

- The "00" setting means that the heater is always ON and the AD-4713 is continuously measuring. The **[STOP]** key must be pressed to stop.

## Set Desired TEMP- Using Wireless Remote Keyboard

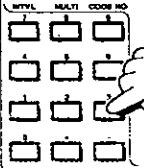

1 Press the **[TEMP]** key.  

○ A "?" question mark will appear.

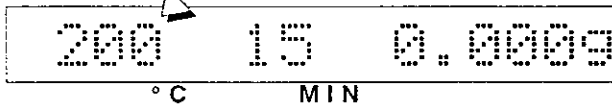
2 Use the keypad to display the temperature desired.  



3 Press the **[ENTER]** key to enter the temperature setting into the balance memory.  

## Set Desired TIME- Using Wireless Remote Keyboard

4 Press the **[TIME]** key.  

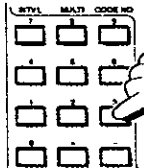
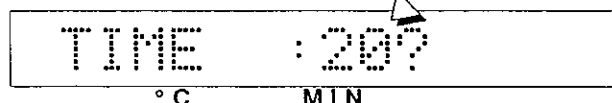
○ A "?" question mark will appear.

5 Use the keypad to display the time desired.  

6 Press the **[ENTER]** key to enter the time setting into the balance memory.  



# Moisture Measurement



Before you start to measure the moisture content of a sample, you must set the temperature and time as described on the pages just before this section.



## Tare the Display, Load Sample, Start

- 1 Use the Pincette to place the Sample Pan *and any aluminum foil that will hold the sample* on the Trivet.

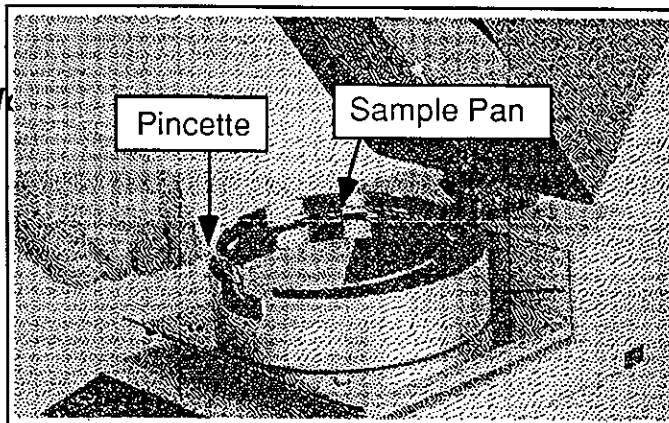
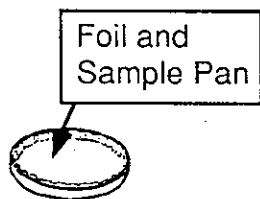

- 2 Press the **TARE** key to cancel the Sample Pan and foil weight.

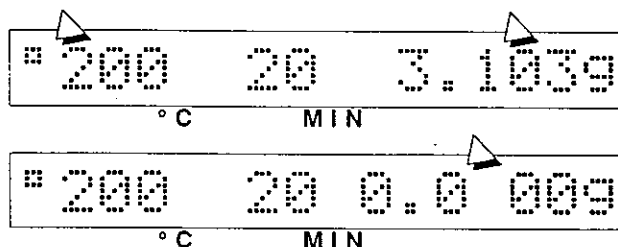
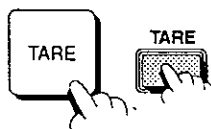



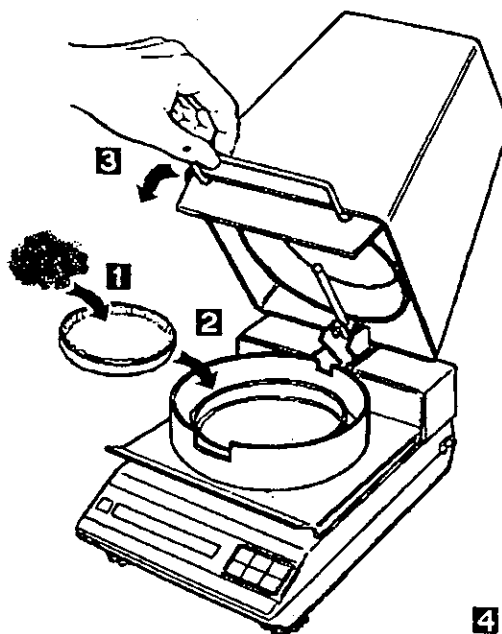

- 3 Place the sample onto the foil in the sample pan, *SPREAD THE SAMPLE EVENLY*. The sample pan may be removed from the balance to load the sample.

⚠ It may be necessary to crush samples such as coal, corn or other grains if you want them to be dried within 20 minutes.

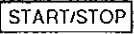
- 4 Firmly close the lamp cover. The sample weight will be displayed.

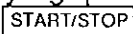

- 5 Press the  key.   

- The IR bulb will come ON and weight display will turn to moisture %. Please watch the drying process and stop it if any irregularities or burning occurs. The  key must be pressed to stop.

- 6 When the heating unit starts, the temperature and time displays will change as the balance works. 

- ⚠ In the time measurement mode, the time will count down from the time setting. In continuous mode (setting '00') the display will count up for elapsed time.



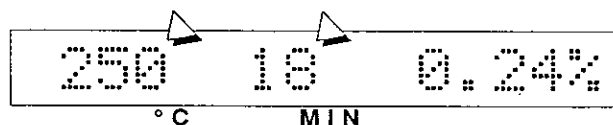

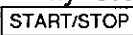
Every 30 seconds, the AD-4713 goes through a measurement/analysis cycle.

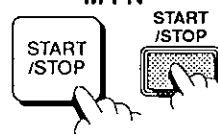

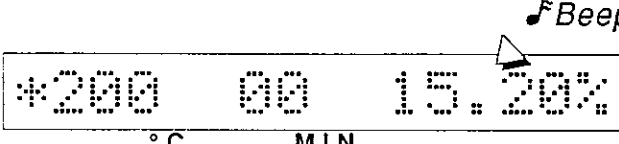
You may stop the cycle at any point by pressing the  key.



- 7 At the end of the moisture analysis cycle (time is up) an electronic alarm tone will sound and the final moisture content will be displayed. 

- 8 If you would like the result in grams, press the  key.   

- 9 Use the Pincette to lift the Weighing Pan off of the trivet. *Do not place it on anything that is heat sensitive.*

- ⚠ Follow the same procedure for another sample if you want, or - if you are finished – switch the AD-4713 OFF.



*If anything should fall into the Weighing Pan Guard, or down into the balance mechanism, it should be removed immediately!*

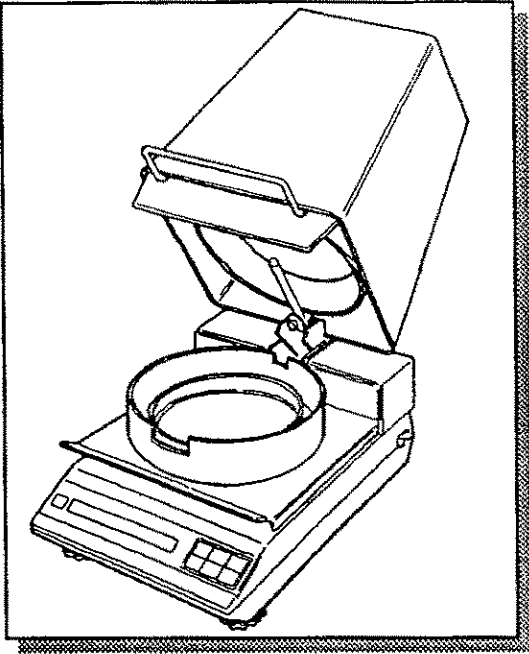

## AD-4713 • Section C

# Modes

# 0.1% or 0.01% Displayed Mode



The moisture percent display can be set at either 0.1% or 0.01% according to your needs by the following procedure:

1

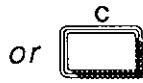
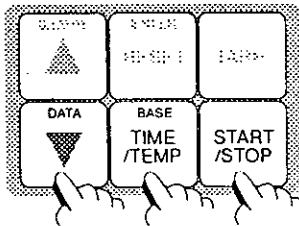

- ▶ Press the **DATA**, **BASE** and the **START/STOP** keys all at the same time, or the **C** key on the wireless remote keyboard.

2

Use the **0.1/0.01** key to rotate the display. Stop at the desired setting, either the 0.1 or 0.01 mode

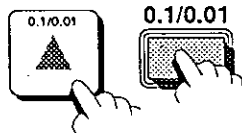

3

Press the **ENTER** key to enter the setting into memory, and the display returns to normal.

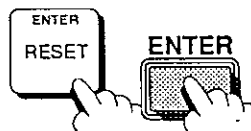

# Wet or Dry Basis Determination



Moisture determination mode can be chosen as either wet or dry basis, and also as dry matter:

$$\text{Wet Moisture percent : (M) wet basis} = \frac{W - W_0}{W} \times 100\%$$

$$\text{Dry Moisture percent : (m) dry basis} = \frac{W - W_0}{W_0} \times 100\%$$

$$\text{Dry -Matter percent} = 100\% - \text{moisture percent (M)}$$

W = Original sample weight

W<sub>0</sub> = Weight of dry matter

1

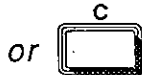
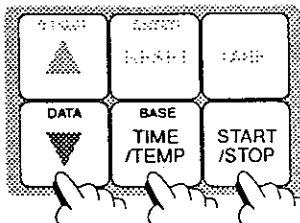

- Press the **DATA**, **BASE** and the **START/STOP** keys all at the same time, or the **C** key on the wireless remote keyboard.

2

Use the **BASE** key to rotate the display. Stop at the desired setting: wet basis, dry basis, or dry-matter (see above)

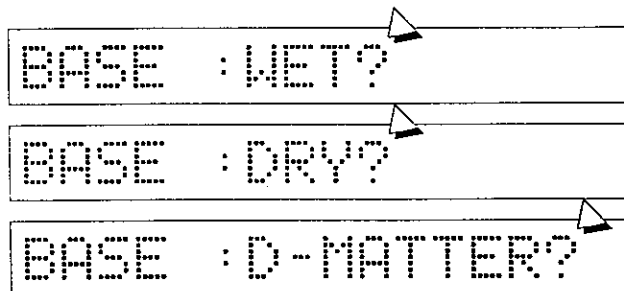
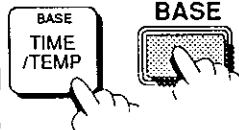

3

Press the **ENTER** key to enter the setting into memory, and the display returns to normal.

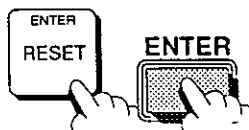





# Measurement Modes



There are four types of measurement modes which can be operator set: 1) Timed measurement, 2) Continuous measurement, 3) Automatic measurement, and 4) Prediction measurement:

**1**

Timed measurement, see Section B, Basic Operation

**2**

Continuous measurement : Time set at 00.

Measurement will continue until **START/STOP** key is pressed.

**3**

Automatic measurement: Time set at 91 to 99.

As shown is the table, a number between 91 and 99 indicates automatic measurement mode. The moisture change is automatically monitored.

For example, if set at 92, the measurement will automatically terminate when the change in moisture does not change more than 0.1% in more than 0.5 minutes. The final indication should be regarded as the moisture percent.

Setting	Rate of change	Supervising Time (min.)
91	0.15 %	0.5
92	0.10 %	
93	0.05 %	
94	0.15 %	2.5
95	0.10 %	
96	0.05 %	
97	0.15 %	5
98	0.10 %	
99	0.05 %	

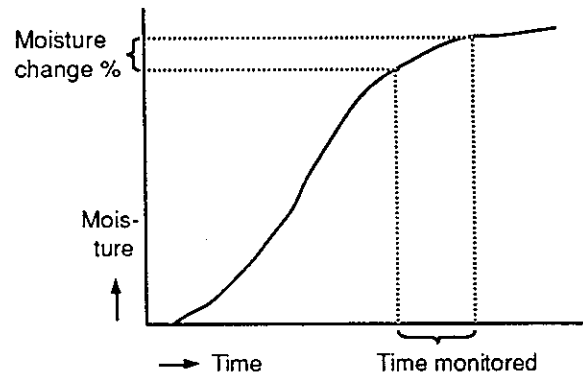

**4**

Prediction measurement (see next section):

Moisture obtained in this mode corresponds to that in the automatic measurement mode (91→99).

If coefficients have been entered properly in advance, Moisture can be obtained in about five minutes.

Coefficients for predict calculation can be entered through automatic or manual setting. Coefficients for up to 7 samples can be entered at 7 positions of time setting 100→106, and they can be changed as required. It can also apply to solid matters.

A set temperature is automatically adjusted to the value at the time of having set the coefficients. (The set temperature cannot be changed because it is made a set with the coefficients).

Selection of the WET base, DRY base and dry matter should be the same as when setting the coefficients. (When different, for example, if you select the dry matter in spite of having set the coefficients with the wet base, a correct moisture value cannot be obtained because a calculation is made with the coefficients for the dry matter). **W**



## Prediction Measurement Mode



There are two settings in this mode which can quickly determine moisture content. You will enter coefficients, either *automatically* by test samples, or *manually* by entering them via the remote keyboard.

### Automatic Setting: See page C-7 for details

Repeating the actual measurement 4 times stores the coefficients in the memory of the AD-4713, and thereafter, those coefficients can be used for measurement.

The method for acquiring the coefficient is to use 4 samples with the approximate moisture content range and the approximate weight values to be used in the subsequent measurements.

This will set a proper coefficient and give accurate predict readings on later samples.

Here is an example that will take in the range of moisture from 12% to 18% at weights from 9 to 12 grams.

Sample	1	2	3	4
Moisture	14%	12%	18%	16%
Weight	9 g	10 g	11 g	12 g

After the 4 samples have been processed by the balance, another set of 4 samples will verify that the coefficient is correct.

### Manual Setting: See page C-12 for details



Calculate the coefficients by doing many moisture measurements, and enter the results into the AD-4713 through the Remote Keyboard. It is necessary to measure 16 or more sets of samples to set the coefficients.



# Automatic Coefficients Setting

## Preparations:



- 1 Prepare 4 samples with the approximate moisture content and weight range to be used. (See page C•6 for an example)
- 2 Preheat the AD-4713 (110°C, about 20 minutes) (in order to stabilize operation).
- 3 Determine in advance a measurement temperature and which automatic measurement mode (91→99) is to be used.
- 4 Distribute the sample uniformly on the sample pan.

## Procedure:

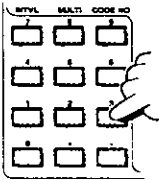

**1** Press the **C** key on the Remote Keyboard.  

**2** Press the **TIME** key on the Remote Keyboard.  



○ A “?” question mark will appear.



**3** Use the keypad to display a coefficient memory number TIME 100→106 to store the coefficients.  

*Disregard the word 'TIME', TIME 100→106 is where memory coefficients are stored, you will recall them later when measuring, again using the 'TIME' display (p. C•13).*

**4** Press the **ENTER** key to enter the setting into the balance memory.  

○ The choice of auto (0) manual (1) mode displayed.

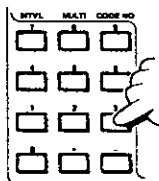
**5** Press the **0** key to select the automatic setting.  

**6** Use the keypad to display the automatic measurement, 91→99, assumed as reference moisture.  

**7** Press the **ENTER** key to enter the setting into the balance memory.



TEMP :             
°C            MIN

**8** Use the keypad to display a measurement temperature.

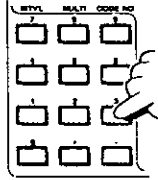

TEMP : 110?  
°C            MIN

**9** Press the **ENTER** key to enter the setting into the balance memory.



ST. +0000.000    9  
°C            MIN

**10** Press the **RESET** key to go to the 1st. measurement display.



110 1st 0.000g  
°C            MIN

○ When ready, start the first measurement ( **START** key).

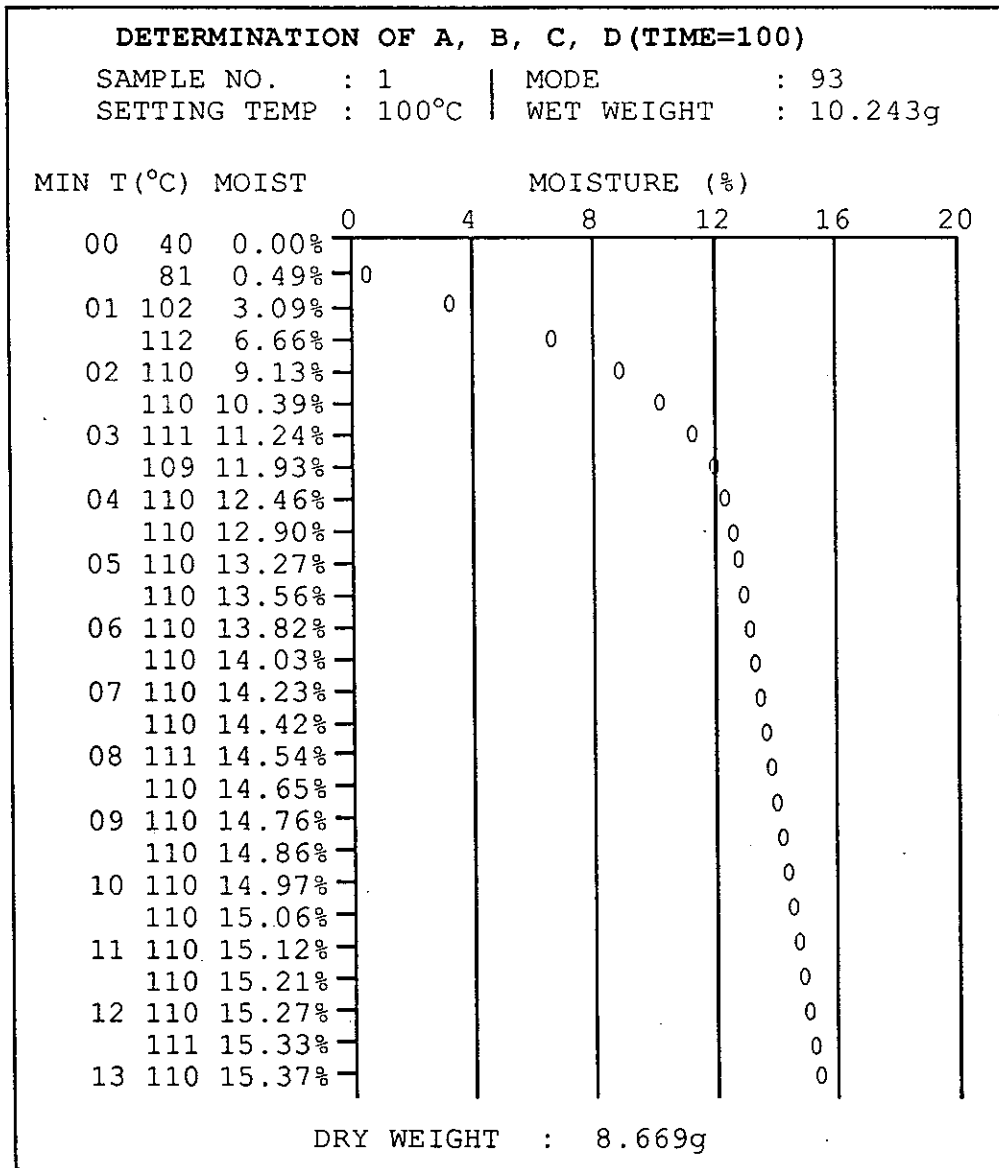



Press the **RESET** key to go to the 2nd. measurement display.



110 2nd 8.515g  
°C MIN

) When ready, start the second measurement ( **START** key).

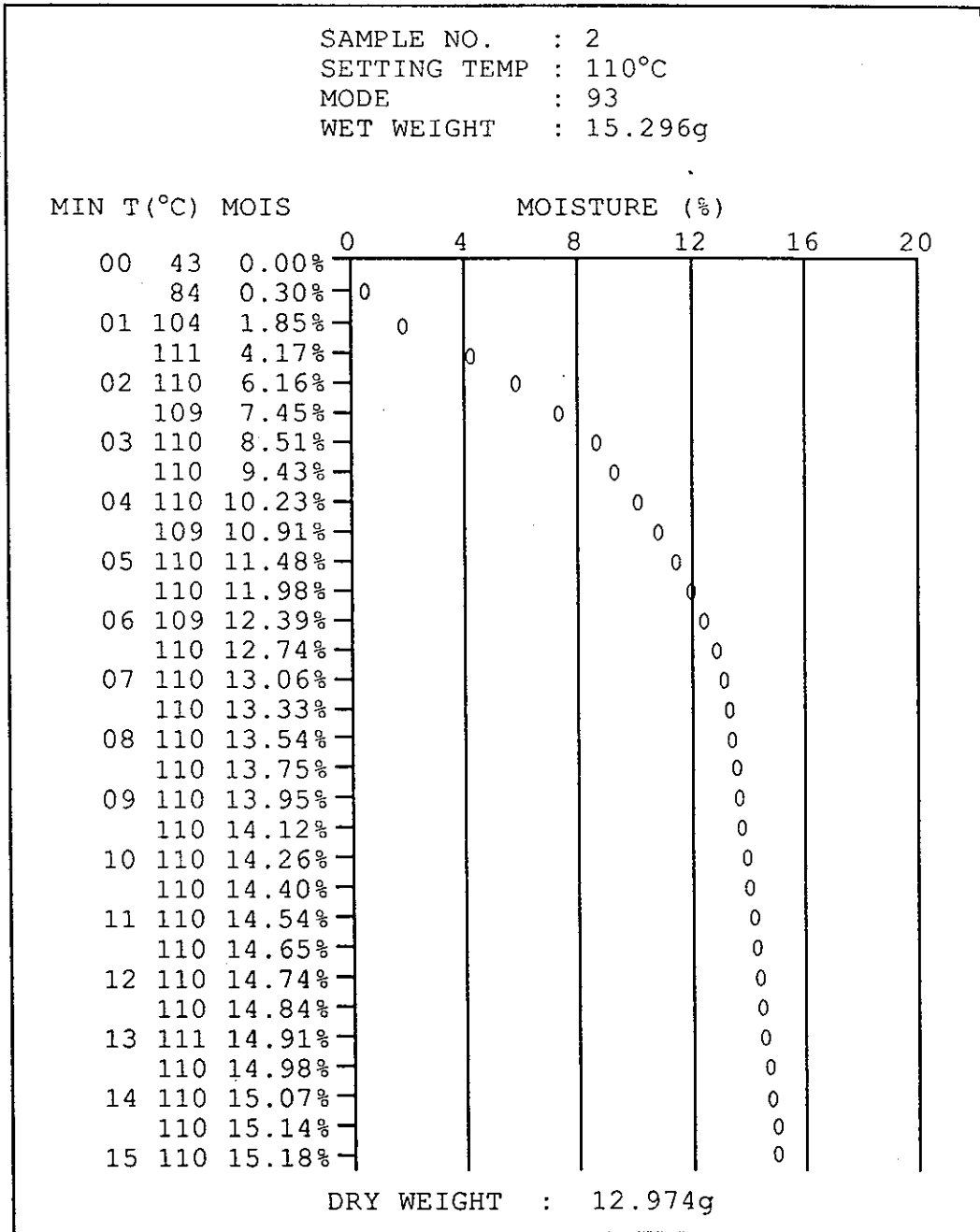



Press the **RESET** key to go to the 3rd. measurement display.

**RESET**



110 3rd 12.970g  
°C MIN

- When ready, start the third measurement ( **START** key).

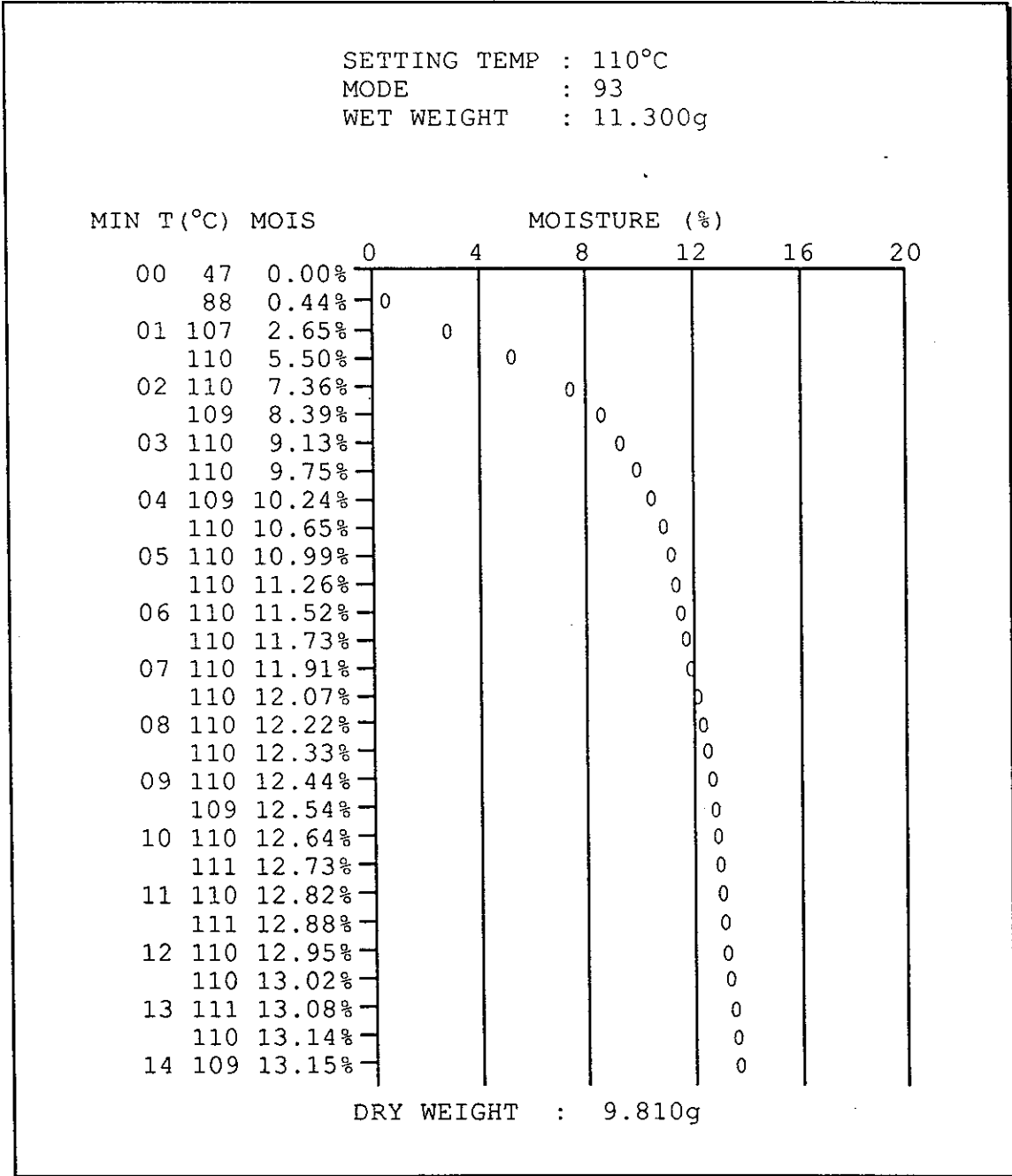

- If you want to invalidate this 3rd measurement, for example, press the **C** key, and repeat the 3rd measurement.



When you invalidate the first measurement, the measurement mode will return to the normal mode ( **ST+0000.000g** ).

Start again with procedure  if you invalidate the first measurement.



Press the **RESET** key to go to the 4th. measurement display.

**RESET**



110 4th 9.822g  
°C MIN

- When ready, start the fourth measurement ( **START** key).

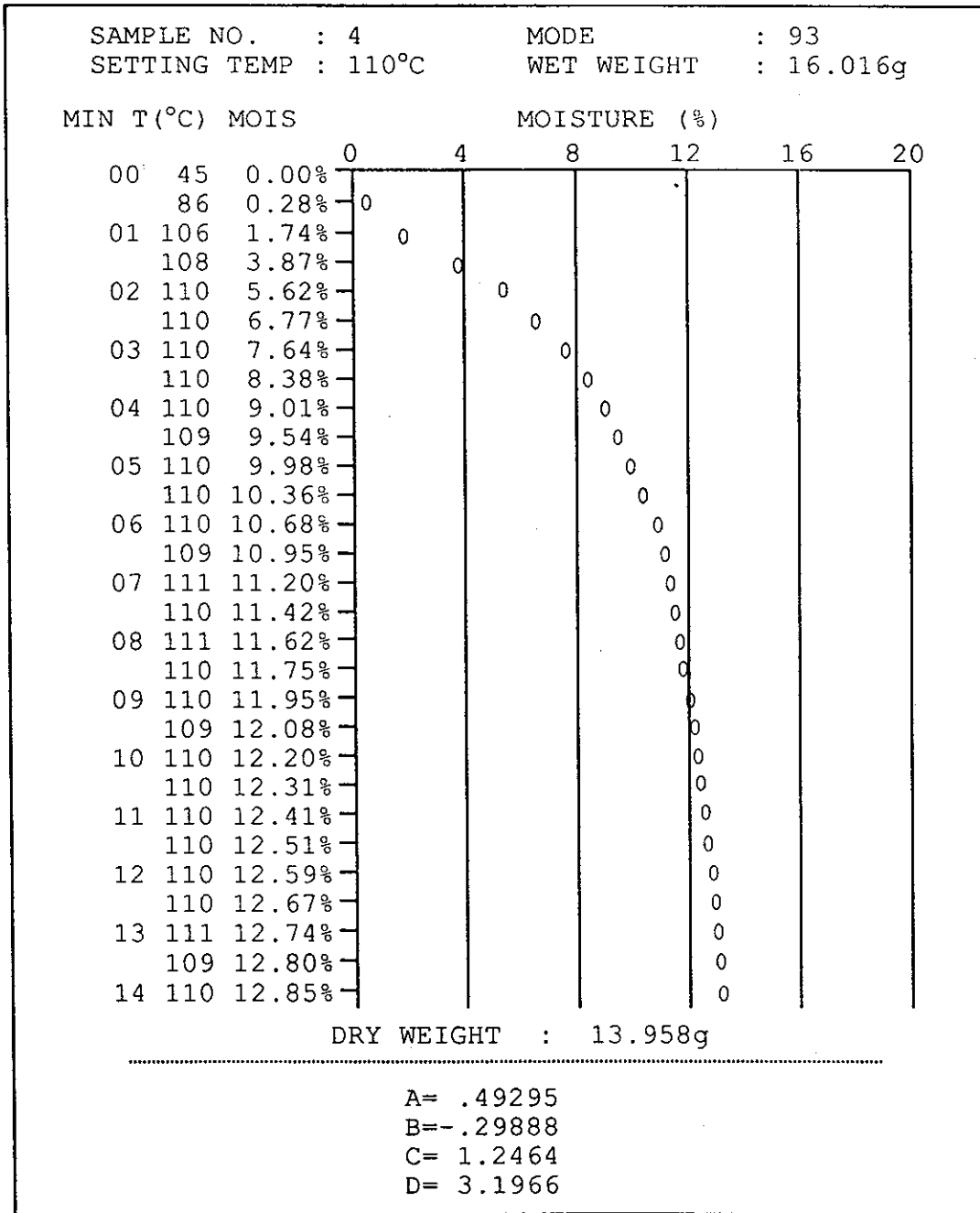

- After measurement is completed, the coefficients A, B, C and D are stored in the specified coefficient memory (TIME 100 in case of this example).



Press the **RESET** key and the coefficient setting has been completed.

**RESET**



110 93 13.960g  
°C MIN





# Manual Coefficient Setting

Moisture M is obtained by the following expression.

$$M = M5 + \Delta 2$$

$$\Delta 2 = (A \cdot \Delta 1 + B) M5 + (C \cdot \Delta 1 + D)$$

where;  $\Delta 1$  : Moisture in 5 minutes - Moisture in 4.5 minutes  
 $\Delta 2$  : Residual moisture  
 $M5$  : Moisture in 5 minutes

Since  $\Delta 2 = (\Delta 1 \cdot M5) A + M5 B + \Delta 1 C + D$ , N-time moisture measurement data is expressed as follows :

$$q_i + x_i A + y_i B + z_i C + p_i D$$

where;  $q_i$  : Final moisture - Moisture in 5 minutes  
 $x_i$  :  $\Delta 1 \times M5$   
 $y_i$  :  $M5$   
 $z_i$  :  $\Delta 1$   
 $p_i$  : 1

$$A = \frac{\begin{vmatrix} \sum q_i x_i & \sum x_i y_i & \sum x_i z_i & \sum x_i p_i \\ \sum q_i y_i & \sum y_i^2 & \sum y_i z_i & \sum y_i p_i \\ \sum q_i z_i & \sum y_i z_i & \sum x_i^2 & \sum z_i p_i \\ \sum q_i p_i & \sum y_i p_i & \sum z_i p_i & \sum p_i^2 \end{vmatrix}}{\Delta} \quad (i = 1 \sim N)$$

$$B = \frac{\begin{vmatrix} \sum x_i^2 & \sum q_i x_i & \sum x_i z_i & \sum x_i p_i \\ \sum x_i y_i & \sum q_i y_i & \sum y_i z_i & \sum y_i p_i \\ \sum x_i z_i & \sum q_i z_i & \sum z_i^2 & \sum z_i p_i \\ \sum x_i p_i & \sum q_i p_i & \sum z_i p_i & \sum p_i^2 \end{vmatrix}}{\Delta}$$

$$C = \frac{\begin{vmatrix} \sum x_i^2 & \sum x_i y_i & \sum q_i x_i & \sum x_i p_i \\ \sum x_i y_i & \sum y_i^2 & \sum q_i y_i & \sum y_i p_i \\ \sum x_i z_i & \sum y_i z_i & \sum q_i z_i & \sum z_i p_i \\ \sum x_i p_i & \sum y_i p_i & \sum q_i p_i & \sum p_i^2 \end{vmatrix}}{\Delta}$$

$$D = \frac{\begin{vmatrix} \sum x_i^2 & \sum x_i y_i & \sum x_i z_i & \sum q_i x_i \\ \sum x_i y_i & \sum y_i^2 & \sum y_i z_i & \sum q_i y_i \\ \sum x_i z_i & \sum y_i z_i & \sum z_i^2 & \sum q_i z_i \\ \sum x_i p_i & \sum y_i p_i & \sum z_i p_i & \sum q_i p_i \end{vmatrix}}{\Delta}$$

where;

$$\Delta = \begin{vmatrix} \sum x_i^2 & \sum x_i y_i & \sum x_i z_i & \sum p_i x_i \\ \sum x_i y_i & \sum y_i^2 & \sum y_i z_i & \sum p_i y_i \\ \sum x_i z_i & \sum y_i z_i & \sum z_i^2 & \sum p_i z_i \\ \sum x_i p_i & \sum y_i p_i & \sum z_i p_i & \sum p_i^2 \end{vmatrix}$$

Enter the resulting A, B, C and D to the AD-4713 by manual setting (See next page).



The number of digits for A, B, C and D is up to 5 numerical digits plus a decimal point, if any, or up to 6 numerical digits, if no decimal point.



# Manual Coefficient Setting

## Preparations:

- 1 Preheat the AD-4713 (110°C, about 20 minutes) (in order to stabilize operation).
- 2 Determine in advance a measurement temperature.
- 3 Perform 16 or more sample moisture determinations.
- 4 Calculate coefficients as demonstrated on page C•12.

## Procedure:



**1** Press the **[C]** key on the Remote Keyboard.  

**2** Press the **[TIME]** key on the Remote Keyboard.  

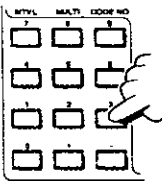
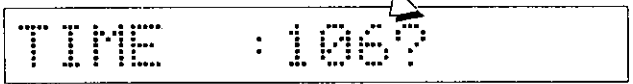
A “?” question mark will appear.

**3** Use the keypad to display a coefficient memory number TIME 100→106 to store the coefficients.  

*Disregard the word 'TIME', TIME 100→106 is where memory coefficients are stored, you will recall them later when measuring, again using the 'TIME' display (p. C•13).*

**4** Press the **[ENTER]** key to enter the setting into the balance memory.  

The choice of auto (0) manual (1) mode displayed.

**5** Press the **[1]** key for the manual setting.  

*No. 106 Coefficient A Memory ▲      ▲ Already Set Value*

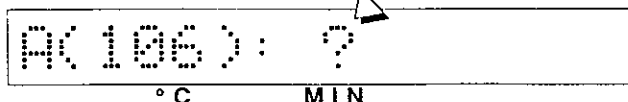
**6** If you need to change the coefficient setting, press the **[C]** key (“?” appears).  

**7** Use the keypad to display the new setting (the **BASE** key acts as a +/- key).

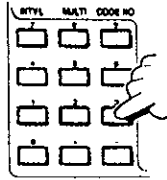

A(106): -1.5479?  
°C MIN

**8** Press the **ENTER** key to enter the setting into the balance memory and move to the **B** coefficient.



B(106): .10752  
°C MIN

**9** Continue to enter the the **B**, **C**, and **D** coefficients, then the **ENTER** key moves to temperature.

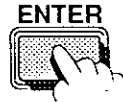

TEMP : 100?  
°C MIN

**10** Use the keypad to display the measurement temperature (if there is a change).

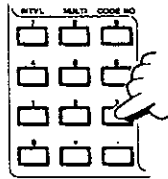

TEMP : 110?  
°C MIN

**11** Press the **ENTER** key to enter the setting into the balance memory.



ST. +0000.000 9  
°C MIN

**12** Press the **RESET** key to go to the measurement display.



# 110 106 0.0009  
°C MIN

# Using the Coefficient Modes

1 Use the keypad or Remote Keyboard to bring up the desired coefficient memory number TIME 100→106. For example, TIME memory 100.

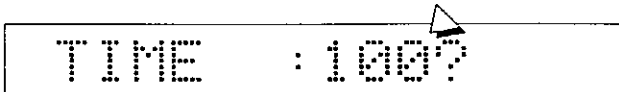

Disregard the word 'TIME'; TIME 100→106 is where memory coefficients are stored, you stored them earlier using the 'TIME' display (p. C-6, C-12).

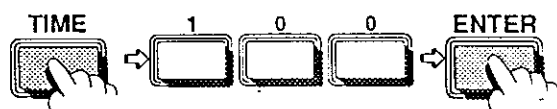

2 Proceed with moisture measurements (pressing the **START** key). Moisture will be measured in 5 minutes. Here are a couple examples:

SAMPLE NO. : 6  
 SETTING TEMP : 110°C  
 MODE : 93  
 WET WEIGHT : 11.588g

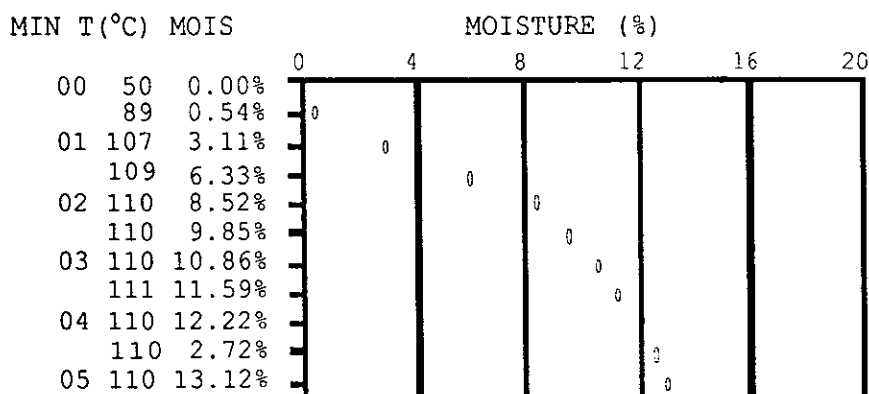

RESIDUAL MOISTURE : 2.36%  
 PREDICTED MOISTURE : 15.48%

SAMPLE NO. : 7  
 SETTING TEMP : 110°C  
 MODE : 100  
 WET WEIGHT : 12.381g

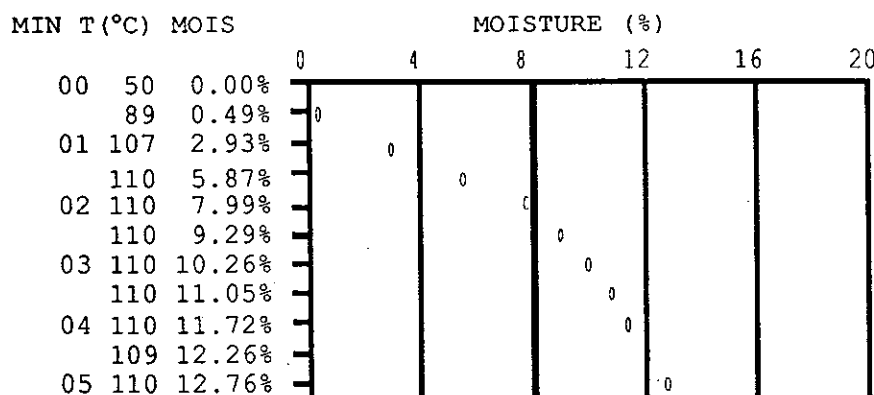

RESIDUAL MOISTURE : 2.70%  
 PREDICTED MOISTURE : 15.40%



# Printer Output



## Date

1 Press the **DATE** key on the Remote Keyboard.



○ A "?" question mark will appear.

2 Use the keypad to display date: Year, Month, Day. Separate by a '.' and **C** clears.

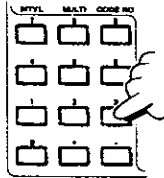

3 Press the **ENTER** key to enter the setting into the balance memory.



## Sample Number

1 Press the **LOT** key on the Remote Keyboard.

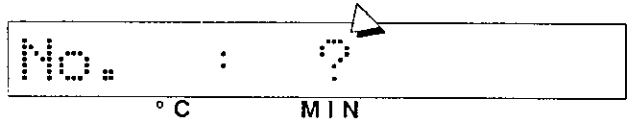

○ A "?" question mark will appear.

2 Use the keypad to display a lot or sample number up to 65535. **C** key clears.

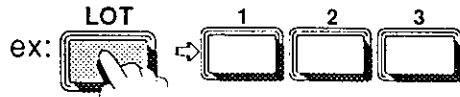
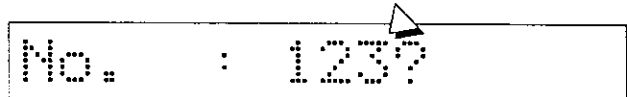
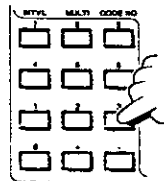

3 Press the **ENTER** key to enter the setting into the balance memory.



# Data Output

Any one of the following four data types can be set (also see page D•4):

- GRAPH : Graphic printout made every 30 seconds.
- LAST DATA : The initial data and final data.
- ALL DATA : Measurement every 30 seconds.
- SERIAL : Serial data is sent from the AD-4713. Data can be sent to a printer or to a computer.

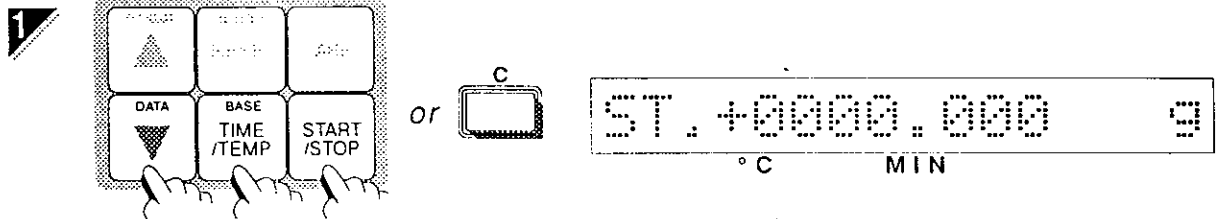

▶ Press the **DATA**, **BASE** and the **START/STOP** keys all at the same time, or the **C** key on the wireless remote keyboard.

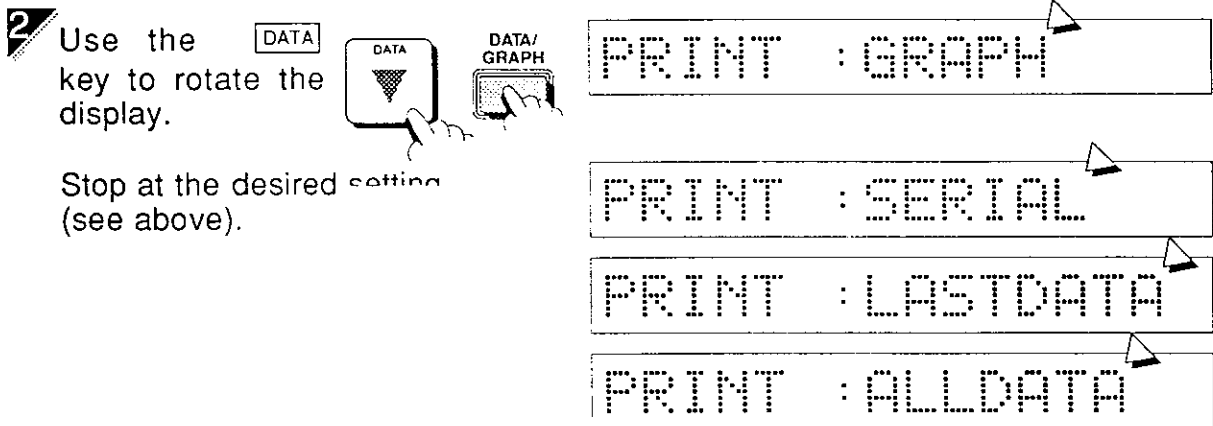

2 Use the **DATA** key to rotate the display.

Stop at the desired setting (see above).

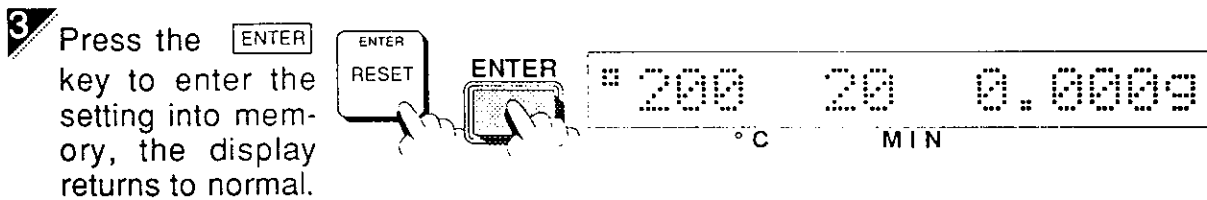

3 Press the **ENTER** key to enter the setting into memory, the display returns to normal.

# Graphic Output Limits (SPAN)

When outputting graphic data, maximum moisture percent needs to be set. Upper limit is set to 100% when DRY MATTER is selected as moisture basis percent (See page C•3).

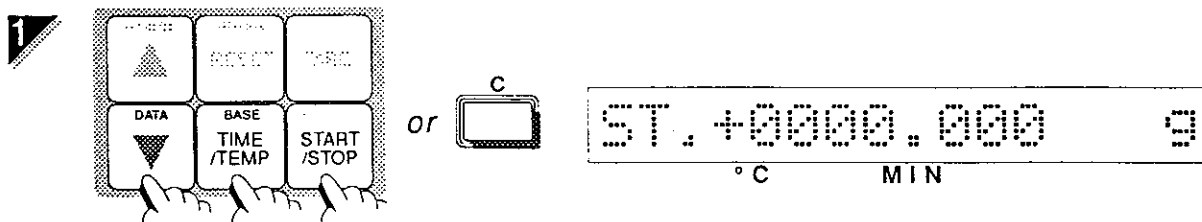

▶ Press the **DATA**, **BASE** and the **START/STOP** keys all at the same time, or

the **[C]** key on the wireless remote keyboard.

**2** Press the **[SPAN]** key on the Remote Keyboard<sup>①</sup> or press both the front panel **[RESET]** and **[TARE]** keys at the same time<sup>②</sup>.



SPAN : ?<sup>①</sup>

SPAN : 100<sup>②</sup>

**3** Use the keypad to display the measurement temperature,<sup>①</sup> or use the front panel **▲** and **▼** keys<sup>②</sup>.

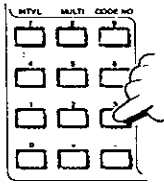

SPAN : 50?<sup>①</sup>

SPAN : 50<sup>②</sup>

**4** Press the **[ENTER]** key to enter the setting into memory, and the display returns to normal.

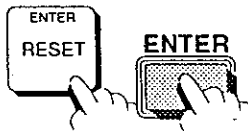

# 200 20 0.000g  
°C MIN

## Graphic Examples

- Sample number : 3
- Drying temperature : 100 °C
- Drying time : 5 minutes
- Measurement mode : Time measurement
- Moisture % format : 001 %
- Moisture basis : Wet base
- Data output : Graphic
- Upper limit of output : 20 %

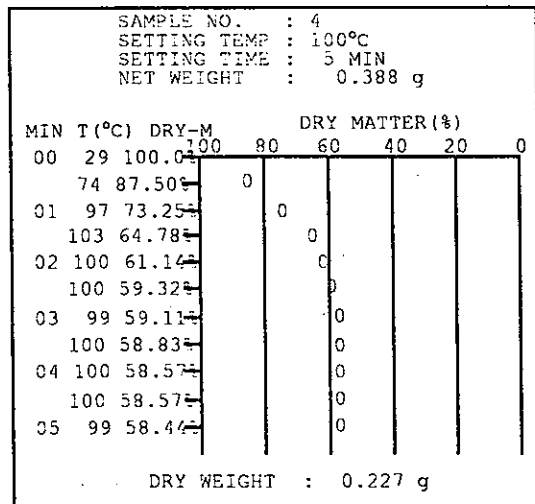
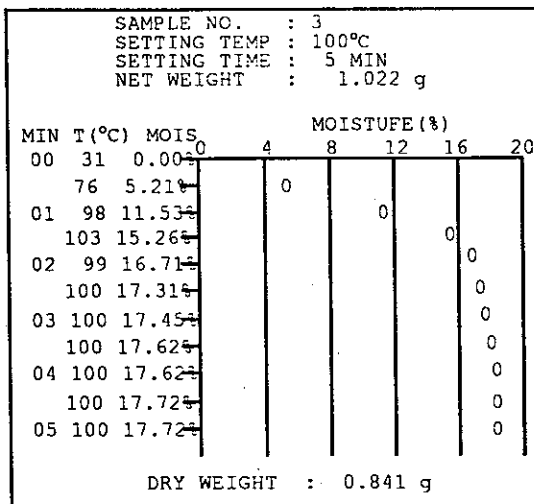

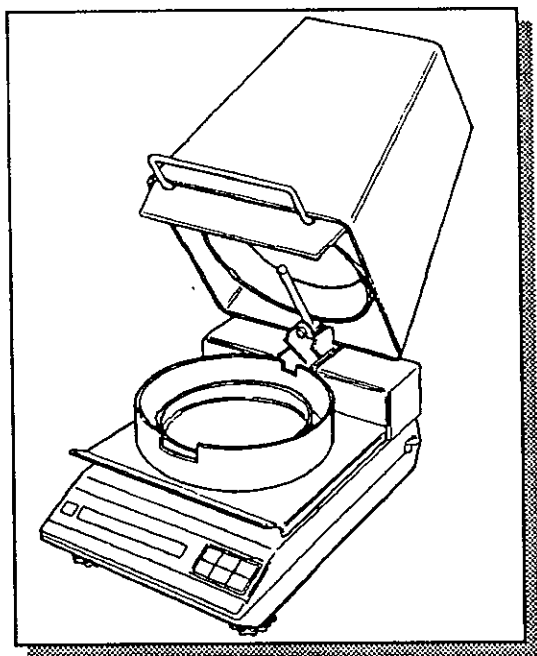

## AD-4713 • Section D

# Serial Interface





# Serial Interface



The AD-4713 comes equipped with a serial interface as a standard equipment and can be easily connected to a printer or a computer to process data.

Data can be output at fixed time interval, printing time, temperature and moisture rates as well as final results, and can also be recorded in the form of graph by using an optional printer. Connecting the computer allows you to not only store data, but also set the temperature and time or control start/stop of moisture measurement



## Specifications

1. System : EIA RS-232C, 20mA current loop (passive)
2. Transmission : Half-duplex start-stop synchronous (asynchronous) system (current loop for transmission only)
3. Signal :
 

Baud rate	2,400 bps
Data bit length	8 bits
Parity bit	None
Stop bit	1 bit

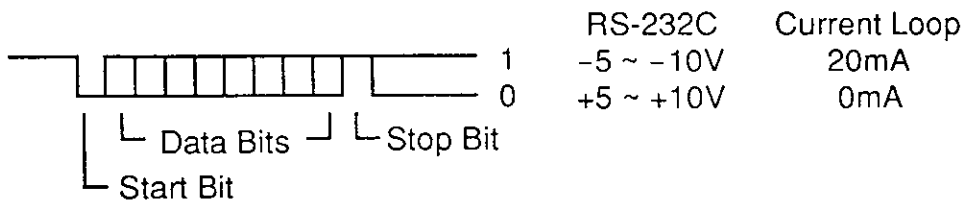

## Pin Connection

RS-232C

Pin No.	Signal Name	Direction	Description
1	FG	← →	Frame ground
2	RXD	In	Receive data
3	TXD	Out	Transmit Data
4	RTS	In	Request to send
5	CTS	Out	Clear to send
6	DSR	Out	Data set ready
7	SG	← →	Signal ground
8 ~ 25	N. C.		No connection

Current Loop

Pin No.	Signal
3, 5	Send loop
2	Ground
Peripheral device	Ground
Others	No connection

## Serial Interface Circuit Diagram

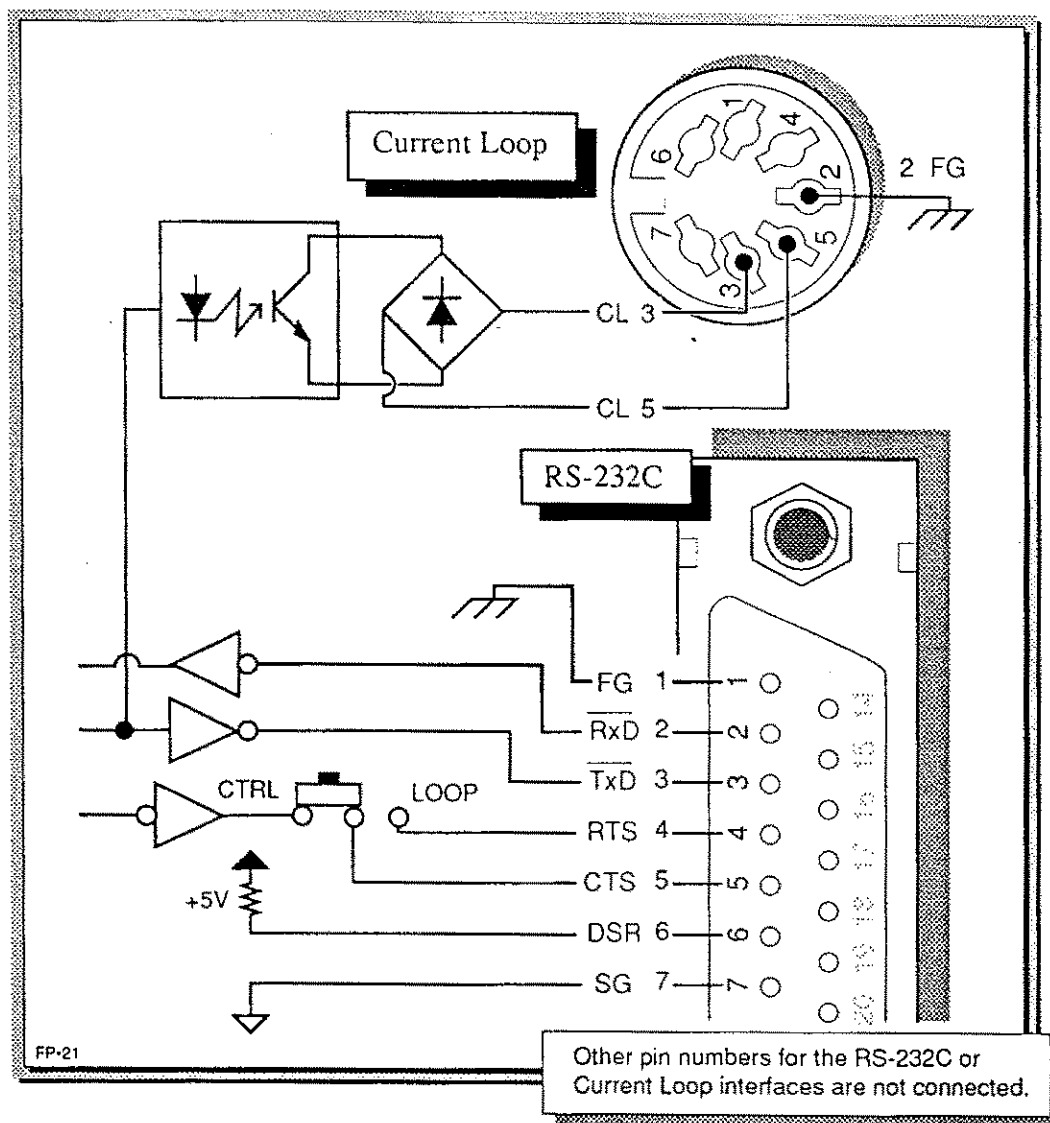

### RS-232C

Applicable connector (option)

JA:HDB-25P (plug)

JA:HDB-CTF (cover)

### Current loop

Applicable connector (accessory)

JA:TCP0576

## Connection Precautions

- 1 Pin connection is DCE (Data Communication Equipment)
- 2 The current loop is a passive type. Use an external 20mA power supply.
- 3 The current loop sends the same data as the RS-232C.
- 4 Before connecting, read the instruction manual for the connected device to fully understand its connecting conditions.
- 5 For a connection cable, use one available for connecting to a modem or an acoustic coupler



# Data Output Mode



The balance software should be set according to how you would like your output. If you are using a computer, then you must choose SERIAL. Since output data contains the code which directly controls the printer, the printers other than AD-8120 may not print data correctly.

## For the Printer

- LAST DATA: Prints initial data upon measurement start and last data upon measurement end.
- ALL DATA: Prints measured values every 30 seconds.
- GRAPH: Prints moisture measured every 30 seconds in the form of graph. (when the option 02 printer is used).

## For a Computer

- SERIAL: Select this setting when connecting to a computer. Data selection, etc. can be set through the computer.



## To Set Data Output Mode

1

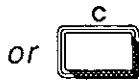
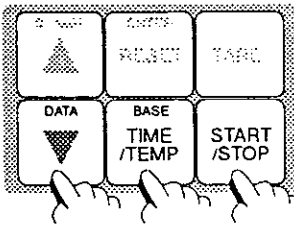

- ▣ Press the **DATA**, **BASE** and the **START/STOP** keys all at the same time, or the **C** key on the wireless remote keyboard.

2

Use the **DATA** key to rotate the display.

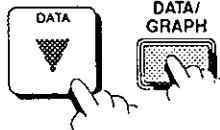

Stop at the desired setting (see above).

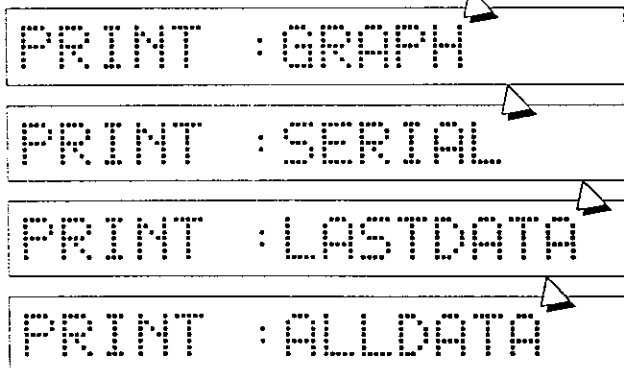

3

Press the **ENTER** key to enter the setting into memory, the display returns to normal.

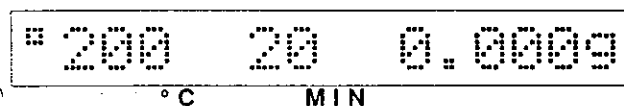
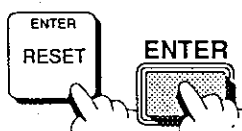



# What a Computer Can Control



## Conditions Settings

 cannot be set at STOP time during moisture measurement.

- 1 Temperature setting : 50 to 250
- 2 Time setting : 0 to 106
- 3 Base selection : WET base, DRY base, dry matter
- 4 Unit selection : 0.1%/0.01%
- 5 Output selection : Select a type of output data
- 6 Temperature symbol setting : Set the output character '°' of °C



## Balance Functions

- 1 TARE : Does not function during moisture measurement.
- 2 START : Does not function during moisture measurement.
- 3 STOP : Functions only during moisture measurement.
- 4 RESET : Functions at STOP time during moisture measurement.



# Serial Interface Commands



All the commands are delimited by CR, LF. All the alphabetical's must be uppercase. Only the commands in the specified format are allowed, and otherwise, they are ignored.



## Temperature Setting Hxxx

- ▣ Where xxx is a number up to 3 digits and ranges from 50 to 250. (Example: H110).
- ▣ A number less than 50 is assumed to be 50, and that over 250 to be 250.



## Time Setting Mxxx

- ▣ Where xxx is a number up to 3 digits and ranges from 50 to 106. (Example: M15).
- ▣ A number over 106 is assumed to be 106.



## Base Selection

- ▣ WET base BW
- ▣ DRY base BD
- ▣ DRY-matter BS

## Unit Selection

- 0.01% D. 1
- 0.001% D. 01

## Output Fh h

For hh, select each item shown in the following table and specify it with a hexadecimal number.

Bit 7	Bit 6	Bit 5	Bit 4	Bit 3	Bit 2	Bit 1	Bit 0
Data interval	Title	No	Time	Temperature	Moisture	Weight	Data format
0: 30sec 1: 10sec	0: Without 1: With	0: Without 1: With	0: Without 1: With	0: Without 1: With	0: Without 1: With	0: Without 1: With	0: Printer 1: computer

When connecting to the computer, set the bit 0 to "1" and select the data output interval with the bit 7. Also, set types of output data with the bit 6 through bit 1.

Example : When the balance measures the temperature and moisture data every 10 seconds data are transmitted as follow;

```

Bit:      7 6 5 4 3 2 1 0
Data:    1 0 0 0 1 1 0 1
Hex:      8      D      → Transmit "F8D".
    
```

## Output Items

- 1 **Title (bit 6)**  
Data sent includes a date (when specified), sample No, set temperature, set time, WET weight, and DRY weight (at the end of measurement)
- 2 **No. (bit 5)**  
Each time data is sent. number is increase by 1. Maximum digit is 5. Upper 0 digits are turned into a space.
- 3 **Time (bit 4)**  
8 digits as a whole. Turned into a space when the hundred minutes digit is 0.  
*Example:* \_00m \_00s (\_denotes a space (20H). The same hereafter)
- 4 **Temperature (bit 3)**  
6 digits as a whole. High-order 0 is turned into a space.  
*Example:* \_105°C.
- 5 **Moisture (bit 2)**  
8 digits as a whole. High-order 0 is turned into a space  
*Example:* \_ \_15.32%

**6 Weight (bit 1)**

8 digits as a whole. High-order 0 is turned into a space.

*Example:* \_12.345 g

**7 Others**

Placed between data is ',' CR, LF is sent at the end of data for one measurement. Upon completion of measurement, "END" CR, LF is sent.

## Temperature Symbol Setting Ohh

For hh, set the output character code 'o' of °C with a hexadecimal number. Factory setting is 20h (space).

## TARE 'T'

Performs taring and cancels the weight display (goes to zero, same function as the **TARE** key on the front panel or Remote Keyboard). Does not function at STOP time or during moisture measurement.

## START/STOP 'S'

In the standard display condition, starts heating and moisture measurement.

Stops moisture measurement when it is under way. Same function as the START/STOP key on the front panel or Remote Keyboard.

## RESET 'R'

Resets to the standard display condition from the moisture measurement mode of STOP mode. Same function as the **RESET** key on the front panel or Remote Keyboard). Function at STOP time during moisture measurement.



STOP or RESET during moisture measurement should be done within 8 seconds after completing data transfer when the data interval is 10 seconds. (within 28 seconds when the data interval is 30 seconds).

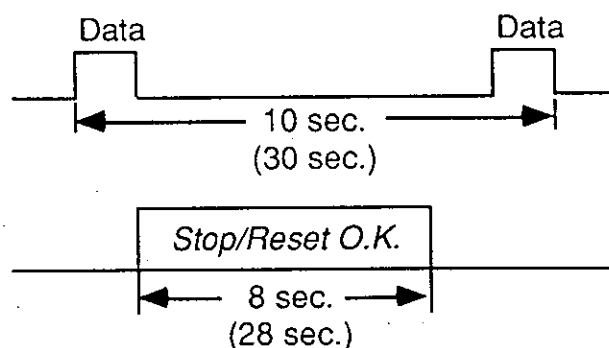



# Printout Examples

## Case 1

Interval time is 10 seconds  
Data bits 1011 1111  
          B    F

1.	00m 00s.	26°C.	0.00%,10.791g
2.	00m 10s.	50°C.	0.01%,10.790g
3.	00m 20s.	60°C.	0.08%,10.782g
4.	00m 30s.	69°C.	-0.23%,10.766g
5.	00m 40s.	77°C.	0.48%,10.739g
6.	00m 50s.	87°C.	0.84%,10.700g
7.	01m 00s.	95°C.	1.27%,10.654g

## Case 2

Interval time is 10 seconds  
Data bits 0001 1101  
          I    D

	00m 00s.	21°C.	0.00%
	00m 30s.	64°C.	0.20%
	01m 00s.	91°C.	1.21%
	01m 30s.	104°C.	2.81%
	02m 00s.	99°C.	4.15%
	02m 30s.	100°C.	4.83%
	03m 00s.	100°C.	5.27%
	03m 30s.	100°C.	5.66%
	04m 00s.	100°C.	5.97%
	04m 30s.	99°C.	6.25%
	05m 00s.	101°C.	6.49%
R		0.00%,P	6.49%
END			

## Case 3

Interval time is 10 seconds

Data bits 1111 1111

F F

SAMPLE NO. : 4  
 SETTING TEMP . 100°C  
 SETTING TIME : 2 MIN  
 WET WEIGHT : 9.997g

1. 00m 00s. 21°C. 0.00%. 9.997g  
 2. 00m 10s. 21°C. 0.00%. 9.997g  
 3. 00m 20s. 21°C. 0.00%. 9.997g  
 4. 00m 30s. 21°C. 0.00%. 9.997g  
 5. 00m 40s. 21°C. 0.00%. 9.997g  
 6. 00m 50s. 21°C. 0.00%. 9.997g  
 7. 01m 00s. 21°C. 0.00%. 9.997g  
 8. 01m 10s. 21°C. 0.00%. 9.997g  
 9. 01m 20s. 21°C. 0.00%. 9.997g  
 10. 01m 30s. 21°C. 0.00%. 9.997g  
 11. 01m 40s. 21°C. 0.00%. 9.997g  
 12. 01m 50s. 21°C. 0.00%. 9.997g  
 13. 02m 00s. 21°C. 0.00%. 9.997g

DRY WEIGHT : 9.997g

## Case 4

Interval time is 10 seconds

Data bits 0011 1101

3 D

1. 00m 00s. 21°C. 0.00%  
 2. 00m 30s. 21°C. 0.00%  
 3. 01m 00s. 21°C. 0.00%  
 4. 01m 30s. 21°C. 0.01%  
 5. 02m 00s. 21°C. 0.01%

END



