

AD-4212F SERIES

AD-4212F-6203D

AD-4212F-10202

AD-4212F-22001

Production Weighing Unit

INSTRUCTION MANUAL





This Manual and Marks Herein





All safety messages are identified by the following: “**CAUTION**” or “**NOTICE**” of ANSI Z535.4 (American National Standard Institute: Product Safety Signs and Labels).

The meanings are as follows:

Meaning of warning signs

 CAUTION	Indicates a hazardous situation which, if not avoided, could result in minor or moderate injury.
 NOTICE	Indicates procedures not related to physical injury.

Meaning of graphic symbols

	This is a safety alert symbol.
	The  symbol indicates what you must not do (prohibited). Specific prohibitions are indicated in writing or by pictures inside or near the  . The figure on the left indicates "No impact".

Others

Note	Describes "when it is easy to mishandle" and "general advice when using this product".
-------------	--

About This Manual

- (1) No part of this manual may be reprinted, copied, modified, or translated to another language without the prior written consent of A&D Company, Limited (A&D).
- (2) The contents of this manual are subject to change without notice.
- (3) Please contact A&D if you notice any uncertainty, errors, omissions, etc. in this manual.
- (4) A&D bears no liability for any loss or lost profits due to the operation of this product, and for direct, indirect, special, or consequential damages resulting from any defect in this product or this manual, even if advised of the possibility of such damage. Furthermore, A&D assumes no liability for claims of rights from third parties. Concurrently, A&D assumes no liability whatsoever for software or data losses.

© 2023 A&D Company, Limited

- Microsoft®, Windows®, Word®, and Excel® are trademarks of the Microsoft group of companies.
- Other product names and company names mentioned in this manual are trademarks or registered trademarks of their respective companies in Japan or other countries and regions.

Contents

1.	Introduction	5
1-1.	Features	5
1-2.	Compliance	8
2.	Part Names, Installation and Precautions	10
2-1.	Assembly and installation	11
2-1-1.	Mass of exclusive weighing pans created by customers	12
2-1-2.	Attaching the weighing unit directly on the mounting base	14
2-2.	Precautions before use (Installation considerations and preparation)	15
2-3.	Precautions when incorporating into a system	16
2-4.	Cautions during use (for more accurate weighing)	20
2-5.	Cautions after use	20
2-6.	Power supply	20
2-7.	Indicator lights	21
3.	Operation of WinCT-AD4212F	22
3-1.	Sensitivity adjustment	26
3-1-1.	Sensitivity adjustment method	27
3-1-2.	Changing weight value	29
3-2.	Self-check function	31
3-2-1.	How to use the self-check function of WinCT-AD4212F	31
3-3.	Filter settings	34
3-3-1.	Standard settings	34
3-3-2.	Customize	35
3-4.	Changing the baud rate using WinCT-AD4212F	49
3-5.	Multiple connections (RS-485)	50
4.	Smart Range Function	52
5.	Impact Shock Detection Function	53
5-1.	Recording impact history	53
5-2.	Outputting impact history	54
6.	Communication Specifications	55
6-1.	RS-232C	55
6-1-1.	RS-232C specification	55
6-1-2.	AX-KO3590-1000 pin position	56
6-2.	RS-485	56
6-2-1.	RS-485 specifications	57
6-2-2.	Pin position when using AX-KO7522-500	57
6-2-3.	Changing device address and terminating resistor settings	58
6-2-4.	Checking device address	58
6-2-5.	How to install the RS-485 interface for daisy chain	59
6-2-6.	Daisy chain connection (communication cable connection)	60
6-2-7.	Daisy chain connection (AC adapter connection)	61
6-3.	Data output format	62
6-4.	Command	63
6-4-1.	AK code and error code	65
7.	Maintenance	71

7-1.	Care	71
8.	Troubleshooting	72
8-1.	Checking the weighing unit performance and environment	72
8-2.	Asking for repair	73
9.	Specifications	74
9-1.	External dimensions	75
10.	Peripherals (sold separately)	76
10-1.	Accessories	76
10-2.	Options	76
11.	Terms	78

1. Introduction

Thank you for purchasing an A&D's AD-4212F Production Weighing Unit.

This instruction manual describes how the AD-4212F series (the weighing unit) works. Please read this manual carefully before using the weighing unit to understand and get the most out of it.

1-1. Features

- The compact weighing unit has a width of only 80 mm, making it ideal for incorporating into production lines.
- The Super Hybrid Sensor (SHS) is used to provide high resolution and fast response time.

Model	Weighing capacity	Readability	Stabilization time*1
AD-4212F-6203D	510 g*2	0.001 g	1.3 seconds
	6200 g	0.01 g	1.0 second
AD-4212F-10202	10200 g	0.01 g	0.5 second (0 to 300 g), 1.0 second (300 to 10200 g)
AD-4212F-22001	22000 g	0.1 g	0.5 second (0 to 300 g), 1.0 second (300 to 22000 g)

*1 When the stability band width is set to ± 3 digits and **FAST** is selected in a good environment.

*2 Smart range (Refer to "4. Smart Range Function".)

- The weighing unit outputs digital data directly via an RS-232C or RS-485 interface. That enables it to be connected directly to a personal computer (PC) or programmable logic controller (PLC).
- Installing an RS-485 interface for daisy chain (accessory AD4212F-29, sold separately) on the weighing unit allows commands to be exchanged between daisy-chained units via RS-485 communication by changing the device address of each weight unit. (Up to 31 units.)
- Dustproof and waterproof (IP65 compliant).
- The WinCT-AD4212F data communication software makes it easy to check weighing values on a PC running Windows. In addition, filter settings can be easily applied as needed for the operating environment, required response speed or desired accuracy, by being graphically simulated.
- Connecting to an AD-8922A remote controller (sold separately) enables reading of the weighing data of the weighing unit and manual re-zero and sensitivity adjustment operations. In addition, the options for BCD output, comparator output, and analog output operations are available for the AD-8922A.
- Connecting to an AD-8923-BCD or AD-8923-CC remote controller (sold separately) enables reading of the weighing data of the weighing unit and manual re-zero and sensitivity adjustment operations. In addition, the AD-8923-BCD is capable of BCD output, and AD-8923-CC can use CC-Link interface.

Note

CC-Link is a high-speed field network allowing simultaneous handling of both control and information.

- By connecting an AD-8551R Modbus RTU converter (sold separately), RS-232C output can be converted into RS-485 communication for Modbus RTU.
- By connecting an AD-8552EIP EtherNet/IP converter (sold separately), RS-232C output can be converted into EtherNet/IP communication.

Example 1 (Connecting to a PC or remote controller AD-8922A)

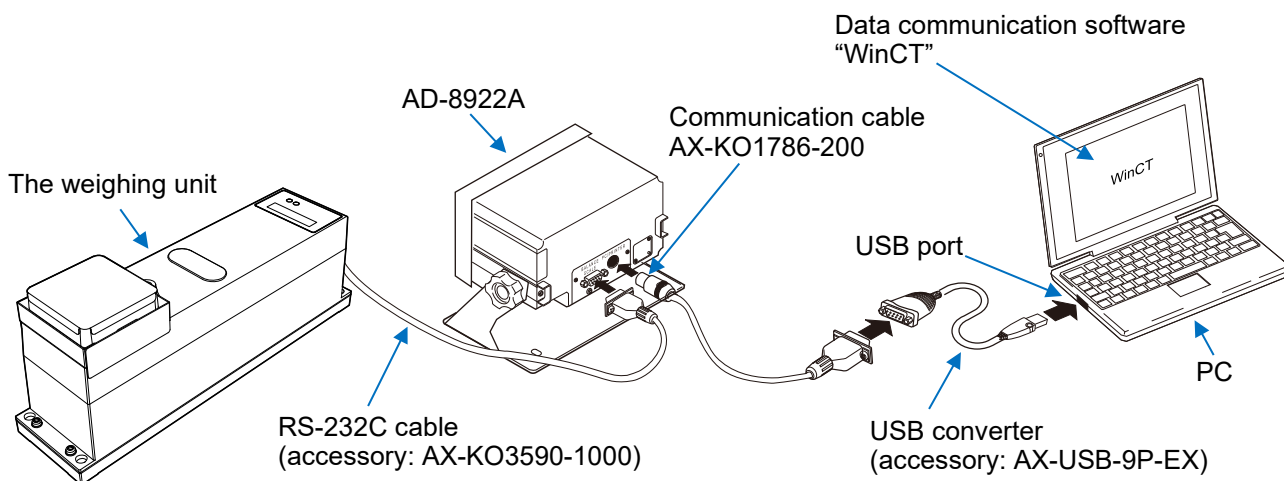
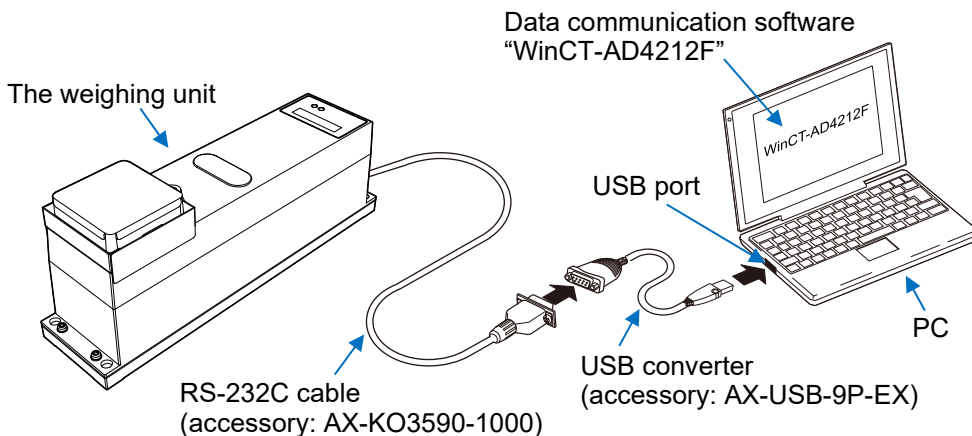

Example 2 (Connecting to a PLC)

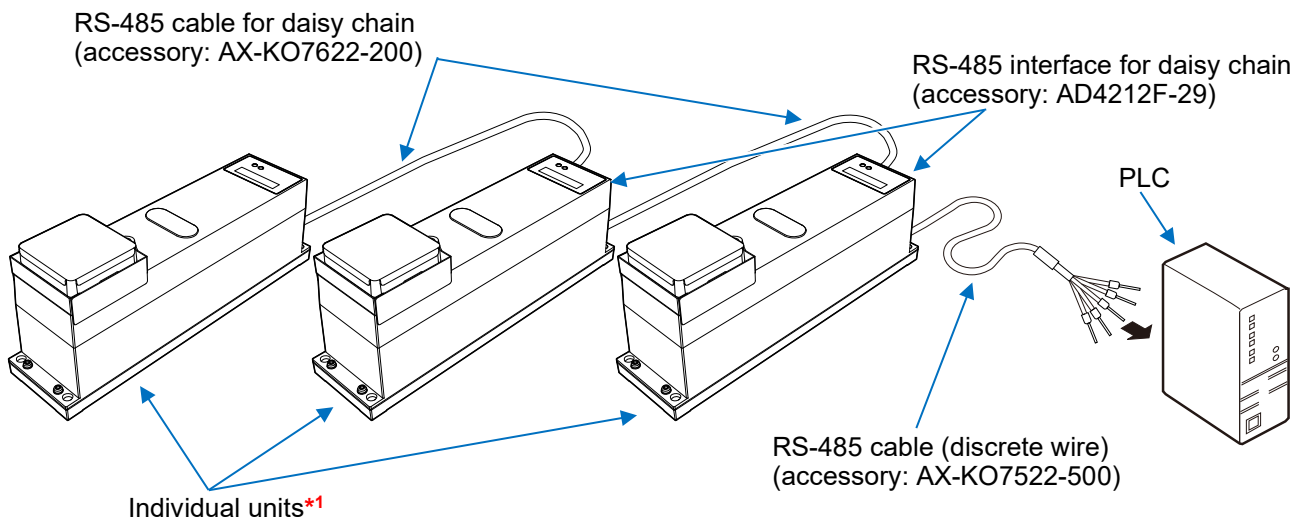
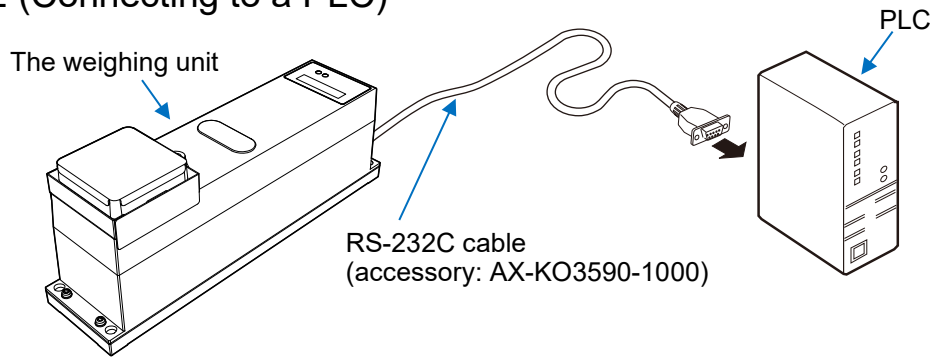

- *1** To connect more than one weighing unit in a daisy chain, an RS-485 interface for daisy chain (accessory AD4212F-29, sold separately) is required for each unit.
Refer to "6-2. RS-485" for installation of the RS-485 interface for daisy chain, daisy-chaining connection, and AC adapter connection.

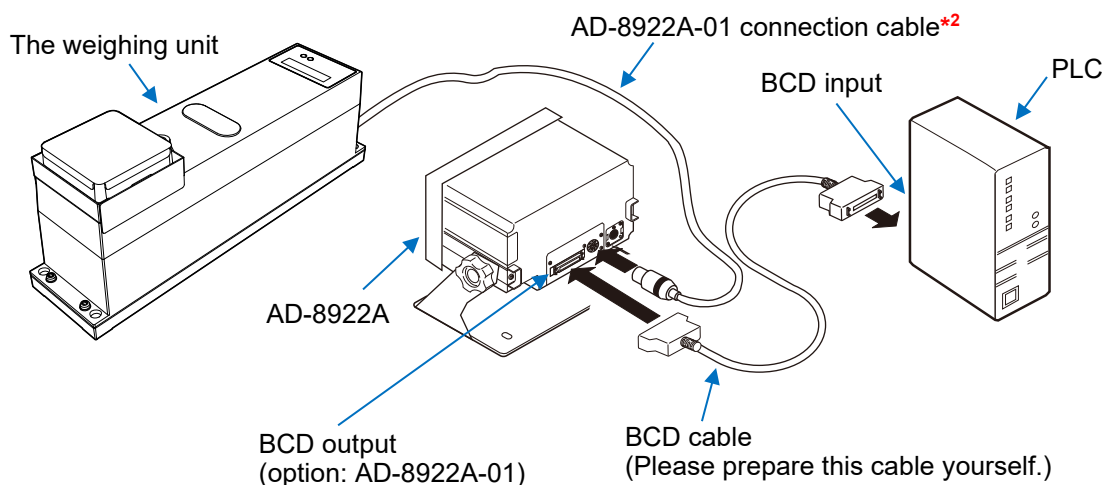

- *2** Please select from below when ordering an AD-8922A-01:

AX-KO3705-200	2 m
AX-KO3705-500	5 m
AX-KO3705-1000	10 m

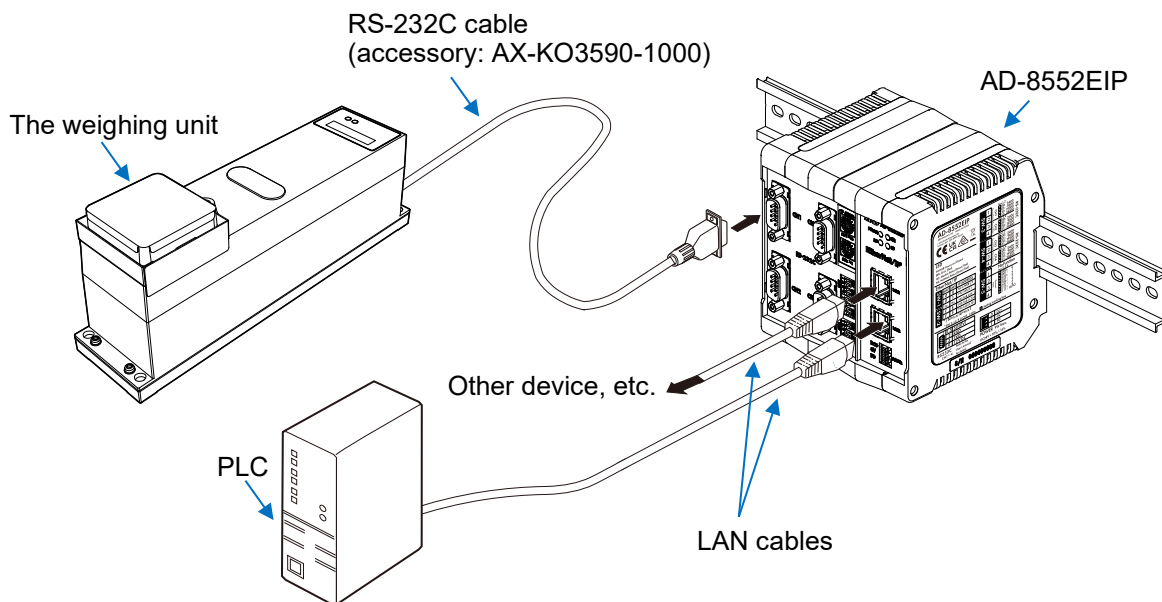
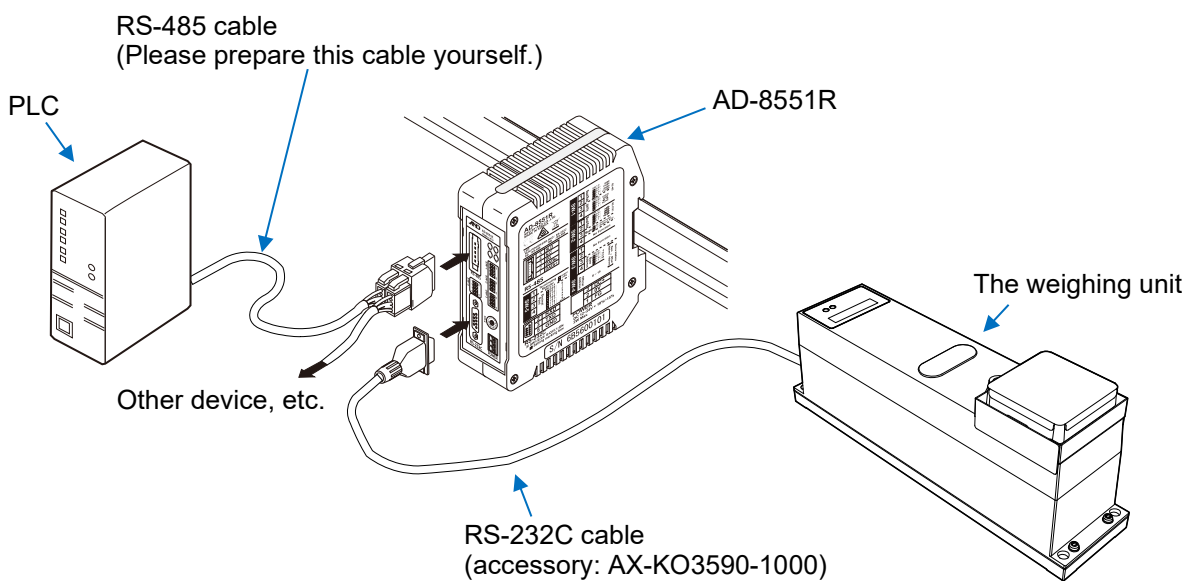
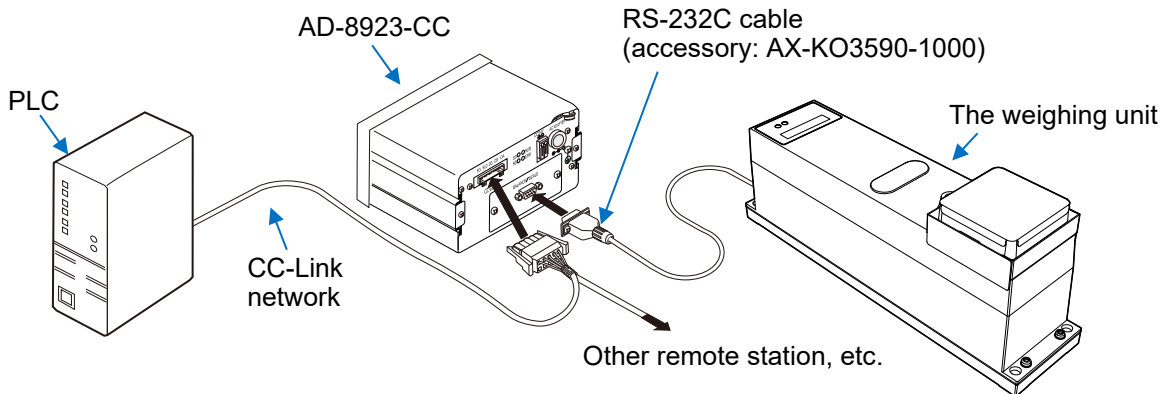

1-2. Compliance

Compliance with FCC rules

Please note that this equipment generates, uses and can radiate radio frequency energy. This equipment has been tested and has been found to comply with the limits of Class A digital devices pursuant to Part 15 of FCC rules. These rules are designed to provide reasonable protection against interference when equipment is operated in a commercial environment. If this unit is operated in a residential area, it may cause some interference and under these circumstances the user would be required to take, at his own expense, whatever measures are necessary to eliminate the interference. (FCC = Federal Communications Commission in the U.S.A.)

2. Part Names, Installation and Precautions

- The AD-4212F (the weighing unit) is a precision instrument. Unpack the product carefully. Keep the packing material for use in transporting the weighing unit in the future for repairs.
- When unpacking, see the illustration below to confirm that everything is included.

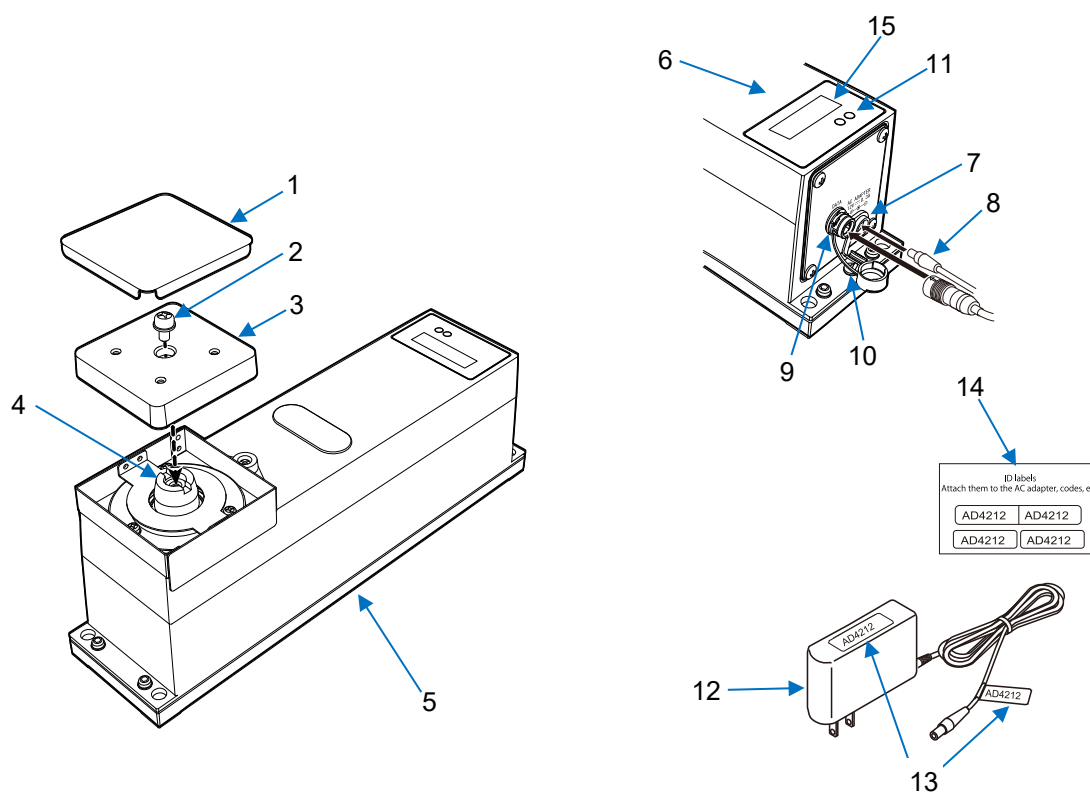

No.	Name
1	Weighing pan
2	Screw for fixing pan support (Pan head screw: M5 screws x 10)
3	Pan support
4	Pan support boss
5	Main body
6	Rear of the main body
7	AC adapter jack
8	AC adapter plug
9	RS-232C output connector*1
10	Grounding terminal*3
11	Indicator lights
12	AC adapter*2
13	Positions of AC adapter ID labels
14	AC adapter ID labels
15	Serial number

*1 The connection cable is sold separately. (Refer to "10-1. Accessories".)

*2 Please confirm that the AC adapter type is correct for your local voltage and receptacle type.

*3 When the weighing unit is incorporated into a system, be sure to ground the weighing unit using the ground terminal.

NOTICE

- Use the specified dedicated AC adapter for the weighing unit.
- Use the included AC adapter, and do not connect an AC adapter that is not compatible.
- If you use the wrong AC adapter, the weighing unit and other devices may not work properly.

2-1. Assembly and installation

1. Consider the cautions described later regarding the place to install the weighing unit.
2. Set the pan support and weighing pan while referring to "[2. Part Names, Installation and Precautions](#)".
3. Securely insert the accessory RS-232C cable into the connection jack on the back of the weighing unit.
(When communicating via RS-485, replace the rear panel with the accessory RS-485 interface and use the accessory RS-485 cable. Refer to "[6-2-5. How to install the RS-485 interface for daisy chain](#)" for how to install the RS-485 interface.)

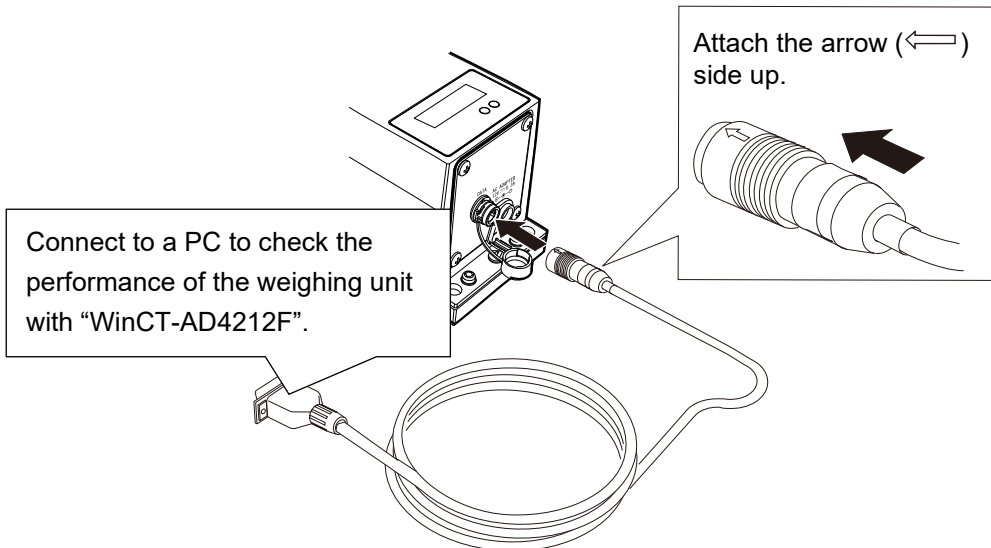

How to disconnect the cable from the weighing unit

Slide the connector sleeve (the part marked with an arrow) to unlock the connector, and then pull out the connector.

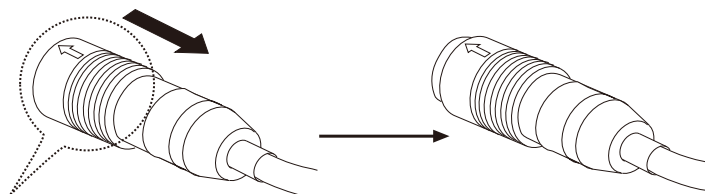

4. Confirm that the AC adapter type is correct for the local voltage and power receptacle type.
5. Plug the AC adapter plug into the AC adapter jack located on the rear of the weighing unit and plug the AC adapter into the electrical outlet. Warm up the weighing unit for at least 30 minutes with nothing on the weighing pan.
6. Set the pan unit and I/O unit to adapt to the peripheral system. Set the following for the I/O unit.
 - RS-232C settings (Refer to "[6. Communication Specifications](#)" for details.)
 - Set the weighing speed (response characteristics) to adapt to the ambient conditions. (Refer to "[3-3. Filter settings](#)" for details.)

NOTICE

- **Start up the PC before connecting to the weighing unit.**
7. After installation, it is advisable to adjust the sensitivity using a weight. (Refer to "[3-1. Sensitivity adjustment](#)" for details.)
 8. If the provided weighing pan is removed, exclusive weighing pans created by customers can be attached to the four screw holes (M4 screw x pitch 0.7 mm) on the pan support.

2-1-1. Mass of exclusive weighing pans created by customers

The weighing pan of the AD-4212F is removable, and customers can create their own exclusive weighing pans as a jig.

When designing your own exclusive jig weighing pan, note that the mass must fall within the ranges shown in the table below. For the mass ranges to be weighed, refer to the figures below the table.

Model	Mass (g) of exclusive weighing pan
AD-4212F-6203D	40 to 6030
AD-4212F-10202	40 to 10030
AD-4212F-22001	40 to 21830

AD-4212F-6203D

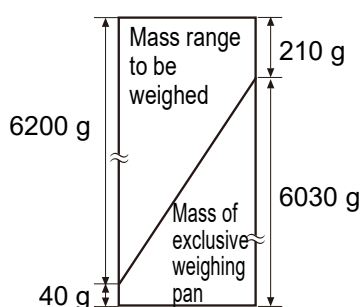

AD-4212F-10202

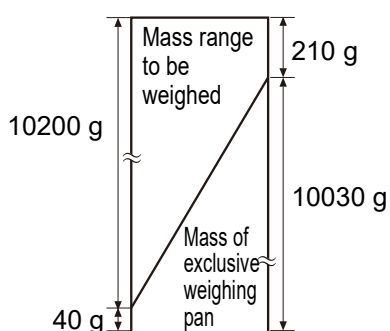

AD-4212F-22001

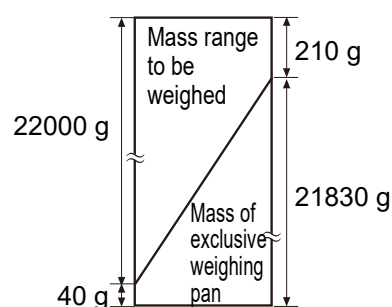

Notes

- For use in a range other than those shown above, contact your local A&D dealer.
- To avoid the effects of static electricity or magnetism, use materials other than resin or magnetic materials when designing a weighing pan.
- When an exclusive weighing pan is used, the zero point may be shifted greatly right after the AC adapter is plugged in. Perform re-zero before weighing to cancel the amount of zero drift as necessary.

Precautions when not weighing at the center of the provided weighing pan

To use your exclusive jig weighing pan instead of weighing at the center of the provided weighing pan, attach the jig so that the total moment of the jig and the object to be weighed is less than the value specified in the table below.

Allowable eccentric load for each model (Nm)

Model	Allowable eccentric load
AD-4212F-6203D	1 Nm or less
AD-4212F-10202	1 Nm or less
AD-4212F-22001	1 Nm or less

AD-4212F-6203D / 10202 / 22001

Example where the total moment of the jig and the object to be weighed is 1 Nm or less:

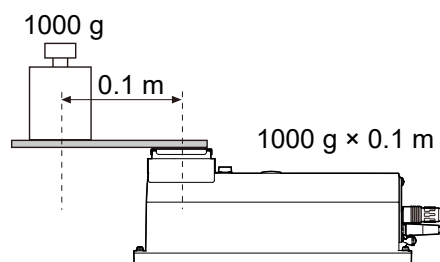

Notes

- The values mentioned above are for reference and may be different from actual specifications.
- Since there is no built-in overload protection mechanism, do not overload.
- When designing jigs and the like, consider that the pan unit may sink slightly if a heavy object is placed on it.

2-1-2. Attaching the weighing unit directly on the mounting base

For stable weighing, fix the weighing unit to the installation platform with screws.

How to attach

Use the screw holes on the weighing unit to fix it.

When screwing from the top: M6 screw × 4

When screwing from the bottom:

M8, P1.25 screw × 4

Notes

- ❑ Please prepare four screws for securing the weighing unit to the platform.
- ❑ For the positions of the holes, refer to “[9-1. External dimensions](#)”.
- ❑ Depending on the conditions in which it is installed, the levelness of the weighing unit may not be adjustable. In such cases, try adjusting the levelness by inserting a shim between the bottom surface of the weighing unit and the securing surface or by using two nuts. Even if the levelness cannot be adjusted, performing sensitivity adjustment before use in the conditions in which the unit is installed will prevent performance problems from occurring.

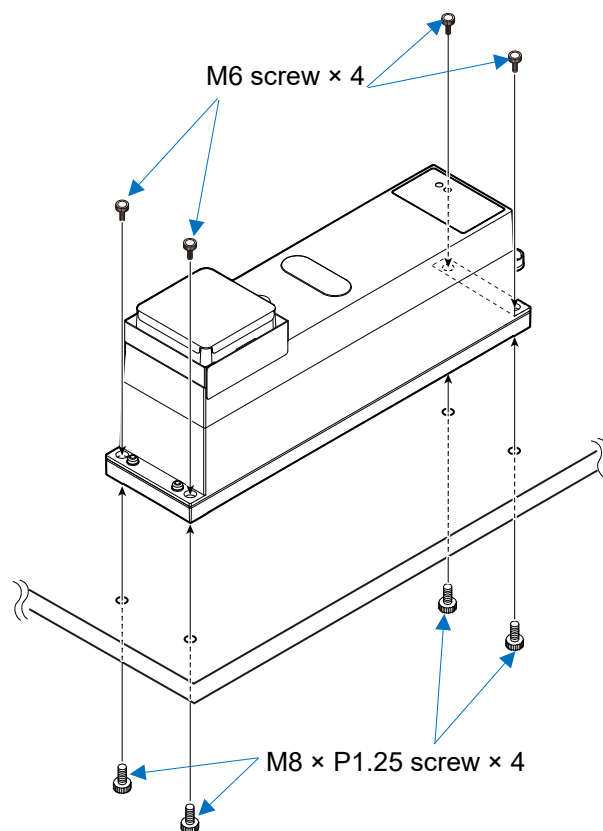
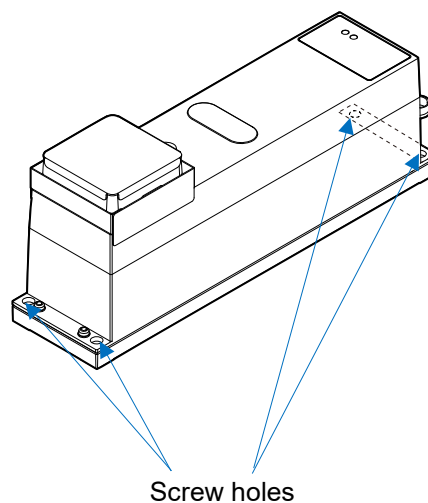

2-2. Precautions before use (Installation considerations and preparation)

Prepare the following conditions in order to bring out the full performance of the weighing unit:

- About dustproof / waterproof performance
 - The dustproof and waterproof level of the weighing unit is equivalent to IP65, and its second digit, "5", corresponds to "having no harmful influence by receiving direct jet of water". Washing with strong water pressure or submersion in water may cause water to enter the balance and cause a malfunction.
 - When installing and using the weighing unit under conditions requiring dustproof and waterproof performance, make sure that the AC adapter plug is fully inserted into the AC adapter jack and that the RS-232C cable or RS-485 cable is attached.
 - When not using the AC adapter or the RS-232C cable, keep the rubber caps of the packing sections closed.

Rear of the weighing unit

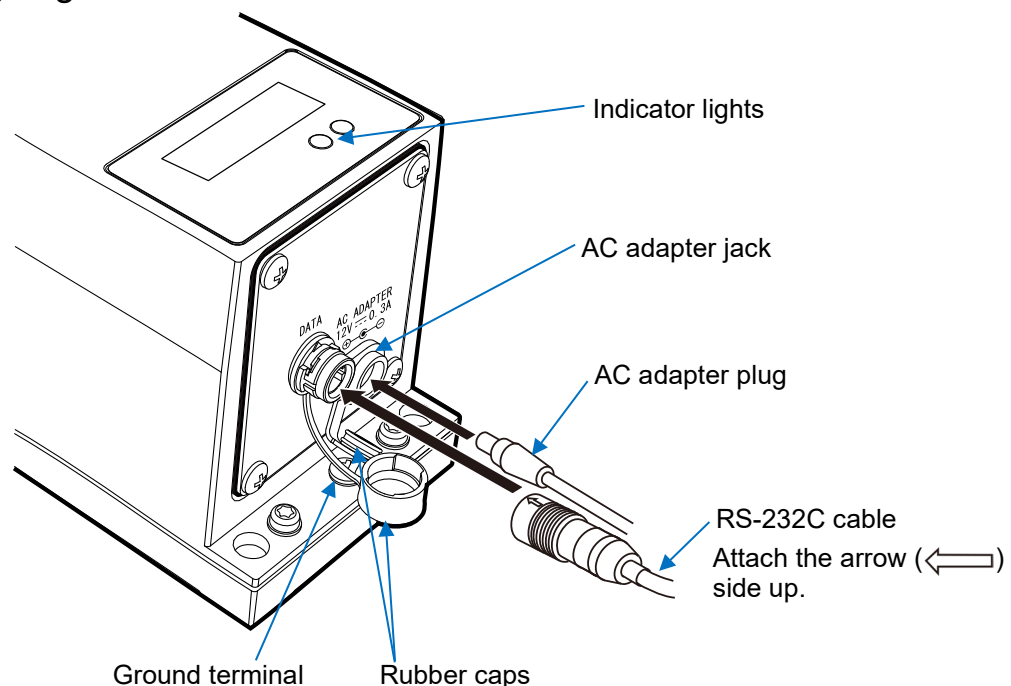

- The ideal installation conditions are a stable environment of $20\text{ }^{\circ}\text{C} \pm 2\text{ }^{\circ}\text{C}$ and humidity of 45 to 60 %RH.
- Use in an environment with as little dust and vibration as possible.
- In a building, places near the walls rather than the central part of a room, and places on the first floor (i.e. the ground floor) rather than the upper floors, are more suitable for weighing operations as they are less prone to vibration.
- Do not install the weighing unit near heating, ventilation, or air conditioning units and the like.
- Avoid locations in direct sunlight.
- Install the weighing unit away from equipment which produces magnetic fields.
- Be sure to warm up the weighing unit before use for at least 30 minutes (with the AC adapter connected to the power supply).
- When the weighing unit is installed for the first time or has been moved, adjust the sensitivity before use to ensure accurate weighing. Perform sensitivity adjustment regularly to maintain accuracy. (Refer to "[3-1. Sensitivity adjustment](#)" for details.)

CAUTION

- **Do not install the weighing unit where flammable or corrosive gas is present.**

2-3. Precautions when incorporating into a system

This weighing unit is a high-precision electromagnetic balance. When it is incorporated into a system, errors such as unstable weighing values may occur due to static electricity, vibration, sample temperature and magnetism of the materials weighed or used for the devices near the weighing unit.

When using the weighing unit as part of a system, take the following precautions:

Notes

- ❑ When fixing the weighing pan to the pan support boss, be careful not to apply excessive rotational force or pressing force.
- ❑ Do not apply force such as pulling up the pan support boss or applying force from the side.
- ❑ Do not apply shock to the weighing pan.
- ❑ Be sure to ground the weighing unit.
- ❑ Keep the power supply line and signal line away from lines that carry large currents, such as the power supply for drive equipment.

Errors due to static charge and countermeasures against those

[Phenomenon]

When the ambient humidity is less than 45% RH, insulators such as plastic or glass are prone to static electricity. When charged material comes close to the weighing unit, a pulling force is generated by static induction between the charged material and the weighing pan. This causes unstable weighing data.

To prevent a malfunction of the weighing unit due to a discharge generated by charged material when it comes close to the weighing unit, be sure to ground the weighing unit.

It is advisable to use a humidifier or the AD-1683 static eliminator because static electricity generated by static induction will not be canceled by grounding.

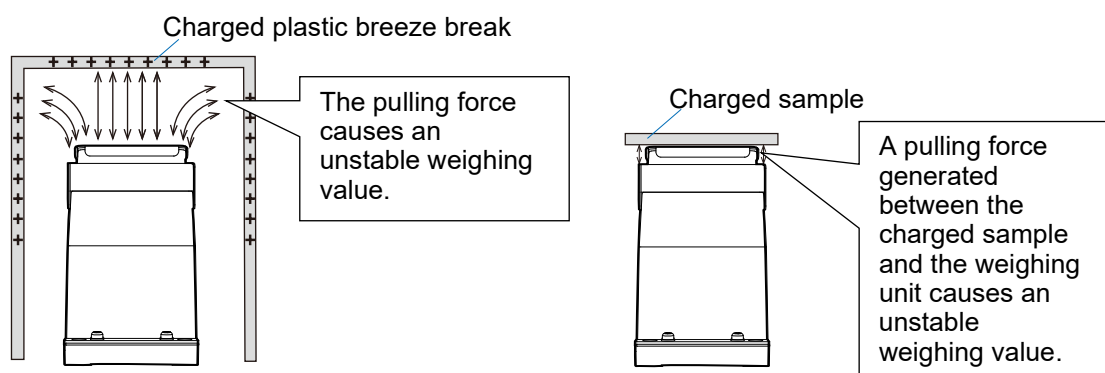

[Countermeasures]

The countermeasures explained below using plastic as an example can also be used for glass.

- **When the sample or workpiece is plastic (especially films)**
 - (1) Use a static eliminator with no fan (no breeze is produced) such as the AD-1683 to remove static electricity.
 - (2) Place the sample or workpiece in a metal or other conductive container to enclose it before weighing it.

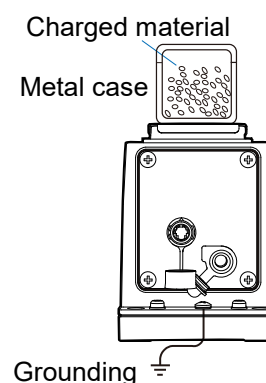

● **When the sample is powder**

When the weighing unit is used in combination with a feeder for batch weighing of powdery samples, samples may be charged by rubbing sample particles against each other.

Use a static eliminator such as the AD-1683 and perform weighing while removing static electricity.

● **When the sample container is made of material that is prone to static electricity (such as plastic)**

(1) Cover the outside of the container with a metal such as aluminum foil.

(2) Apply an anti-static agent onto the container.

● **When making devices for blocking air current (breeze breaks) using plastic**

Apply antistatic agent or use conductive acrylic resin, etc. to prevent static buildup.

● **When plastic exists in the weighing unit installation site**

If the plastic is electrically charged, it may attract the weighing pan or the sample or workpiece, resulting in unstable weighing data.

(1) Cover the plastic with a grounded conductive material.

(2) Apply an anti-static agent onto the plastic.

● **When an operator is static charged**

In the winter when temperatures are low, the operator's clothing is more likely to be electrically charged, and the weighing data may become unstable when the operator approaches the weighing unit. Take measures against static electricity, such as wearing an antistatic wrist strap.

Errors due to airflow and countermeasures against those

● **Effects of airflow**

Weighing data may become unstable due to air currents in the following locations: (1) near the outlets of heating, ventilation, or air conditioning units, (2) near entrances or exits, and (3) near corridors, etc.

Even airflow so weak that it is undetectable by humans can cause the weighing value of the weighing unit to become unstable.

Weighing operations in such locations should be avoided if possible.

If weighing operations in such locations cannot be avoided, take measures such as installing breeze breaks while referring to "[Errors due to static charge and countermeasures against those](#)".

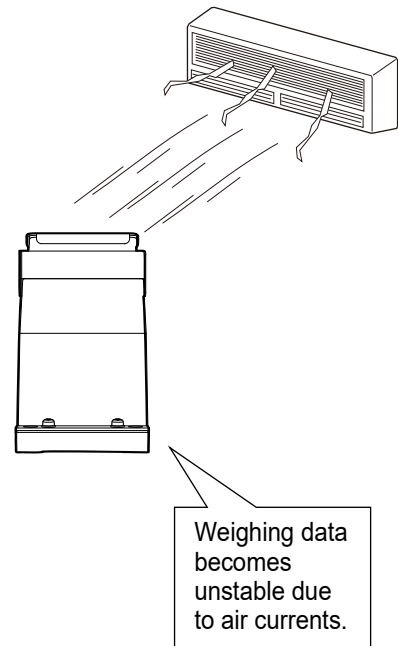

● Effects of heat and convection

- Weighing errors may occur if there is a difference between the ambient temperature and temperature of the sample (and the container). For example, when the room temperature is 20 °C, convection occurs around a flask that is 40 °C and the balance displays a value lighter than the actual weight. Before weighing the sample and the container, try to acclimatize them to the ambient temperature.
- The same phenomenon as above will occur if the sample is held directly by hand, as the temperature of the sample rises due to body heat. Do not hold it by hand; rather, use tweezers or the like to manipulate it.
- Locations exposed to direct sunlight, such as near a window, may cause rapid temperature changes and convection currents. Take measures such as shielding from heat or changing the location.

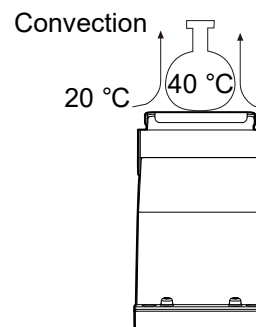

Errors due to vibration and countermeasures against those

Weighing data may become unstable on windy days or after an earthquake in the following locations: (1) weak ground, (2) floors higher than the first floor, (3) near the center of a room, etc. with the pillars spaced wide apart, (4) earthquake-resistant structures, and (5) near tall buildings.

Especially in cases (4) and (5), continuous low-frequency vibration caused by strong winds or an earthquake may persist and cause the weighing data to become unstable for a long period of time.

Errors due to moving the weighing unit

The performance of the weighing unit is guaranteed when it is used in a stationary condition.

If the weighing unit is incorporated into a system that moves the weighing unit, you must carefully perform checks in advance while paying attention to the following:

- If the weighing unit is moved, it may be damaged by impact shocks.
In addition, the weighing value will be unstable immediately after the weighing unit is moved. Avoid sudden movements, stops, or impact shocks, and provide a sufficient waiting time for the weighing value to stabilize when acquiring weighing data.
- The moving device should have a structure where the weighing unit can be kept level.
If the level is shifted, the zero point or sensitivity will be shifted, so perform re-zero operation or sensitivity adjustment.
- In order to avoid the influence of vibration, the moving platform should have a structure not easily susceptible to vibration by means such as reducing the play of moving parts.

Errors due to other causes and countermeasures against those

● Effects of changes in temperature or humidity

Sudden environmental changes can cause convection or moisture absorption / release, and such factors may cause the display of the weighing unit to become unstable.

Avoid sudden changes in temperature or humidity as much as possible.

It is advisable to use air conditioners, humidifiers, and the like to control the temperature and humidity.

● Influence of magnetic materials

Influence of magnetism may cause weighing errors.

To perform weighing of magnetic materials (iron, magnets, etc.), measurement errors must be considered and checked before weighing by means such as placing a non-magnetic material (aluminum, brass, etc.) between the sample and the weighing unit and keeping away from the weighing unit.

2-4. Cautions during use (for more accurate weighing)

For accurate weighing, please pay attention to the following points.

- ❑ To minimize the affect by electrical noises, ground the weighing unit and the optional display unit.
- ❑ When placing a sample on the weighing pan, do not drop it, or do not place a sample greater than the weighing capacity of the weighing unit. Place the sample in the center of the weighing pan to minimize corner-load errors.
- ❑ To prevent possible errors, use a command to re-zero, or calculate the weighing data based on the difference before and after weighing.
- ❑ The measurement results contain errors due to air buoyancy. The buoyancy of air varies depending on the sample volume, atmospheric pressure, temperature, and humidity.
- ❑ Although the weighing unit is dustproof and waterproof complying with IP65, be sure to clean and control the weighing pan and the area around the pan when weighing powders, fluids, or metal pieces.

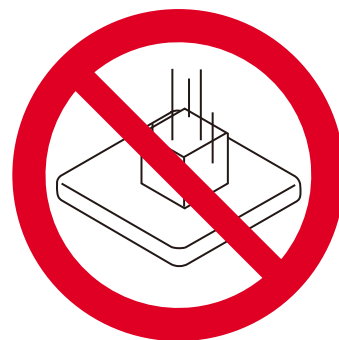

2-5. Cautions after use

- ❑ Avoid mechanical shock to the weighing unit.
- ❑ Adjust the sensitivity of the weighing unit regularly using a weight.
- ❑ Do not disassemble the weighing unit. Contact your local A&D dealer if the weighing unit needs service or repair.
- ❑ Do not use organic solvents to clean the weighing unit. Clean the weighing unit with a lint free cloth that is moistened with warm water and a mild detergent.
- ❑ Prevent foreign substances such as powder and liquid from entering the weighing unit.

2-6. Power supply

The weighing unit is constantly provided with power as long as the AC adapter is connected.

The weighing unit is not adversely affected in this state. It is advisable to always keep the weighing unit in this state for accurate weighing.

2-7. Indicator lights

The weighing unit uses two indicators to indicate the following.

Color	When	Description
Green	Lit	Power is on.
	Blinking	Blinks correspond to the baud rate setting* ² (Only when power supply begins.)
Red	Lit	Non-weighing values (e.g., re-zero, sensitivity adjustment in progress) are output.
	Blinking	Warning that impact has been applied to the weighing unit* ¹

*¹ Refer to "5. Impact Shock Detection Function".

*² See below for the number of blinks and the corresponding baud rate setting, and how to count the number of blinks.

Number of blinks	Baud rate
1	600 bps
2	1200 bps
3	2400 bps
4	4800 bps
5	9600 bps
6	19200 bps
7	28800 bps
8	38400 bps
9	115200 bps

E.g.) Number of blinks: 3 (2400 bps)

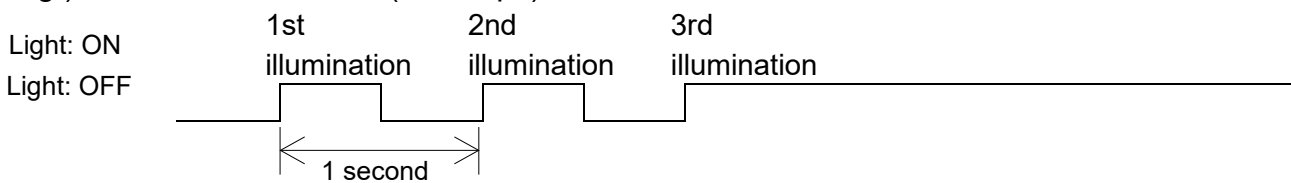

3. Operation of WinCT-AD4212F

Using WinCT-AD4212F enables

- Setting and simulation of weighing speed (response characteristics) of the weighing unit
- Setting of the readability digit
- Sensitivity adjustment
- Setting of the baud rate
- Performance of self-inspection
- Confirmation of impact history

In addition, since the weighing data is logged, it is possible to check the weighing data later.

NOTE

- **The values set above are stored in non-volatile memory even if the power of the weighing unit is removed.**

Before use

To download WinCT-AD4212F, please visit our website:

Go to <https://www.aandd.jp/products/software/software.html>, click on WinCT-AD4212F, and fill out the form to download the software.

Step	Description												
1	Install WinCT-AD4212F on your PC. For the installation method, refer to the Readme of WinCT-AD4212F.												
2	Click Language (L) in the menu of WinCT-AD4212F and change to the language of your choice. (From here on, explanations will be given for when the language set to English.)												
3	Connect the D-Sub 9-pin side of the RS-232C cable (sold separately) connected to the weighing unit to the D-Sub 9-pin connector of the PC. An accessory USB converter (AX-USB-9P-EX) is available if your PC does not have a D-Sub 9 pin connector.												
4	Match the communication settings of WinCT-AD4212F to those of the weighing unit. The default settings for the weighing unit and the initial settings for WinCT-AD4212F are the same below. <table border="1" data-bbox="260 797 1406 992"> <thead> <tr> <th>Setting items</th> <th>Set value</th> </tr> </thead> <tbody> <tr> <td>Baud Rate</td> <td>2400</td> </tr> <tr> <td>Parity</td> <td>E</td> </tr> <tr> <td>Length</td> <td>7</td> </tr> <tr> <td>Stop Bit</td> <td>1</td> </tr> <tr> <td>Terminator</td> <td>CR/LF</td> </tr> </tbody> </table> (Clicking the Baud rate scan button detects the baud rate of the weighing unit and automatically matches the setting.)	Setting items	Set value	Baud Rate	2400	Parity	E	Length	7	Stop Bit	1	Terminator	CR/LF
Setting items	Set value												
Baud Rate	2400												
Parity	E												
Length	7												
Stop Bit	1												
Terminator	CR/LF												
5	Set the COM port of WinCT-AD4212F.												
6	Click the Start button.												
7	When the connection between the product and WinCT-AD4212F is established, the Start button will change to the End button and the weighing data will be displayed on the display screen.												
8	Click the End button to disconnect the weighing unit from WinCT-AD4212F.												

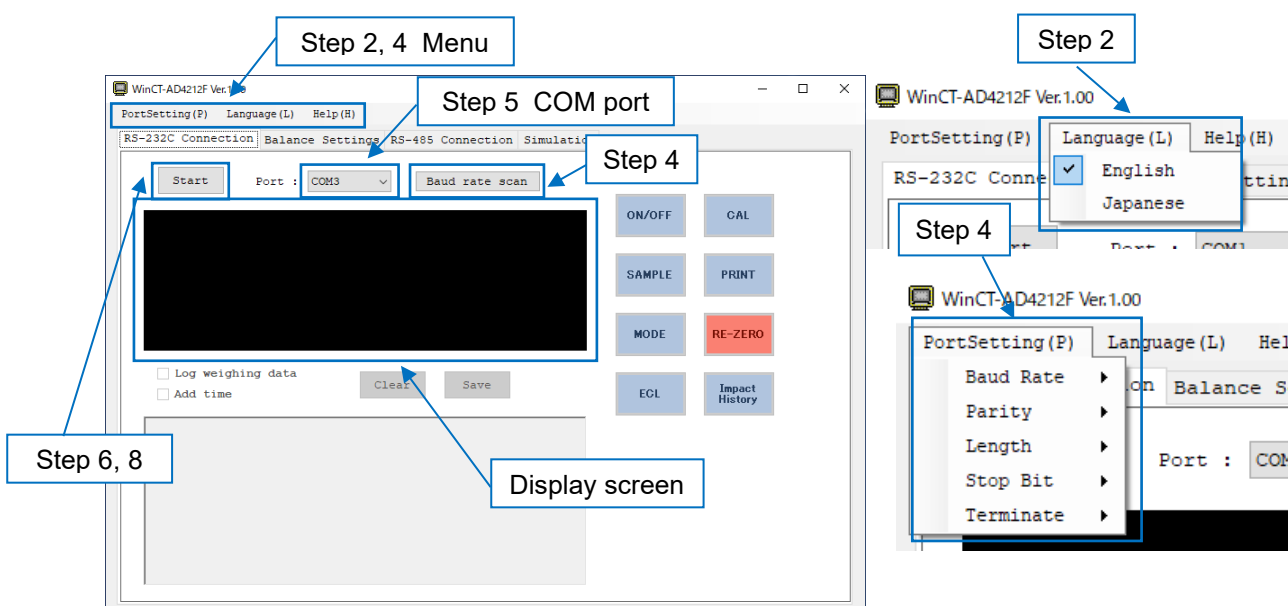

Screen parts and buttons

Importing weighing data

By operating WinCT-AD4212F while a connection between the weighing unit and WinCT-AD4212F is established, the data output from the weighing unit can be recorded and output as text data.

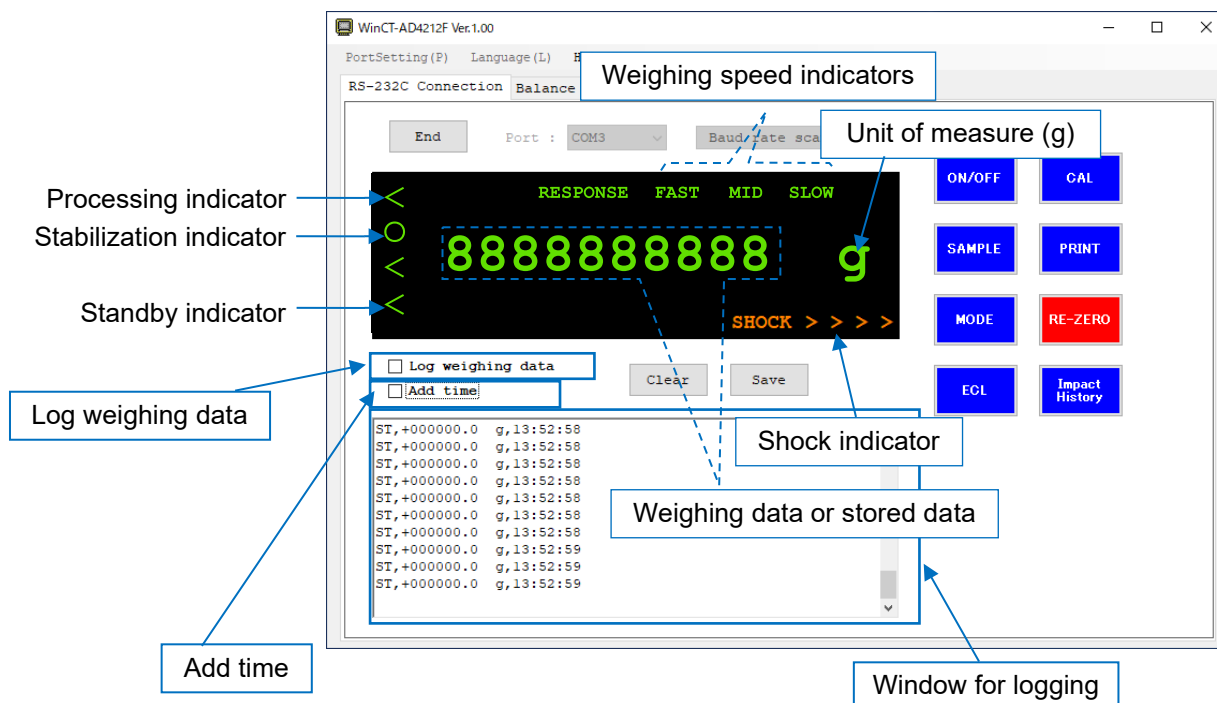

Button	Description
	Switches between weighing mode and standby mode. In standby mode, only the standby indicator is displayed. The ON/OFF button is always active, and clicking the button puts the weighing unit into standby mode at any time during operation.
	Switches the readability digit when clicked in weighing mode.
	Changes the weighing speed.
	Activates sensitivity adjustment mode.
	(Does not function in normal mode. Used in sensitivity adjustment mode.)
	Sets the display to zero.
	Executes the self-check function.
	Outputs impact history.

Item	Description
Log weighing data	If checked, the weighing data will be recorded in the logging window. Weighing data will not be recorded if the check box is not checked. (ECL result and impact history are recorded.)
Add time	When checked, the time of reception will be added to the record.
<div data-bbox="172 465 316 524" style="border: 1px solid black; padding: 2px; display: inline-block;">Clear</div>	Deletes recorded data.
<div data-bbox="172 560 316 618" style="border: 1px solid black; padding: 2px; display: inline-block;">Save</div>	Saves the recorded data as a text file.
Shock indicator	Displays the impact level when the weighing unit detects an impact. For details, refer to " 5. Impact Shock Detection Function ".
<div data-bbox="172 797 440 842" style="border: 1px solid black; padding: 2px; display: inline-block;">Baud rate scan</div>	Automatically detects the baud rate of the weighing unit to automatically match the baud rate of the WinCT-4212F to the setting of the weighing unit.

3-1. Sensitivity adjustment

About sensitivity adjustment

This is a function to adjust the sensitivity of the weighing unit using a weight.

Sensitivity adjustment can be performed without removing the exclusive weighing pan or jig attached to the weighing pan. (Note that the total of the exclusive weighing pan or jig and the weight used must not exceed the capacity of the weighing unit.)

Caution on sensitivity adjustment

- Do not allow vibration, drafts, or temperature change to affect the weighing unit during sensitivity adjustment.

Caution on using an external weight

- The accuracy of the weight used for sensitivity adjustment determines the accuracy of the weighing unit after sensitivity adjustment.

Display



This indicator means the weighing unit is measuring sensitivity adjustment data.

Do not allow vibration or drafts to affect the weighing unit while this indicator is displayed.











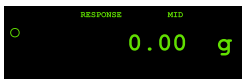
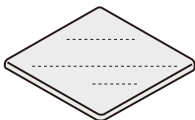



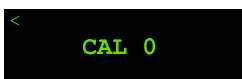

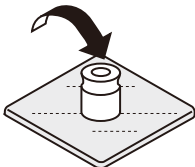
3-1-1. Sensitivity adjustment method

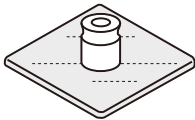
Adjust the sensitivity using a weight.

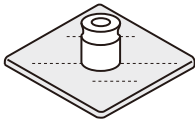
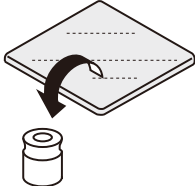
The weight value used for sensitivity adjustment can be changed from the factory setting. To change the weight value, refer to "3-1-2. Changing weight value" and select the weight value in advance.

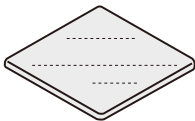

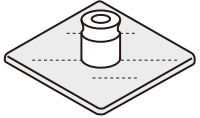

Method of operation

Step	Description	Display and button operation	Weighing operation
1	Warm up the weighing unit for at least 30 minutes with nothing on the weighing pan.		
2	In weighing mode, click the CAL button. CAL 0 is displayed. Make sure that nothing is on the weighing pan.	 	
3	Click the PRINT button. The zero point is measured. (The < mark is displayed on the upper left of the screen.) Do not apply vibration and the like to the weighing unit.	 	
4	The weight value is displayed. Place the weight on the weighing pan.		
5	Click the PRINT button. The external weight is measured. (The < mark is displayed on the upper left of the screen.) Do not apply vibration and the like to the weighing unit.	 	
6	END is displayed. Remove the weight from the weighing pan.		 
7	When the weight is removed, the display returns automatically to weighing mode.		

Step	Description	Display and button operation	Weighing operation
8.	Place the weight on the weighing pan again to check if the sensitivity adjustment was performed correctly. If it is not correct, start over from step 2 in the appropriate ambient conditions.		

Button operations used for sensitivity adjustment

These are the button operations used in steps 3 to 5 of "[Method of operation](#)".

Button	Description
	Switches to standby mode.
	When clicked with <input type="text" value="CAL 0"/> displayed, the weight value used for sensitivity adjustment is changed. For details, refer to " 3-1-2. Changing weight value ".
	Cancels the sensitivity adjustment and returns to weighing mode.
	Confirms the action and proceeds to the next step.

3-1-2. Changing weight value

The weight value used for sensitivity adjustment can be changed.









Select the weight to use from Table 1 below.

Table 1. Weights usable for sensitivity adjustment

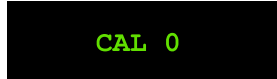
Model	Usable weight
AD-4212F-6203D	50 g, 100 g, 200 g, 300 g, 500 g, 1000 g, 2000 g*, 3000 g, 4000 g, 5000 g, 6000 g
AD-4212F-10202	500 g, 1000 g, 2000 g, 3000 g, 4000 g, 5000 g*, 6000 g, 7000 g, 8000 g, 9000 g, 10000 g
AD-4212F-22001	1000 g, 2000 g, 5000 g, 10000 g*, 20000 g



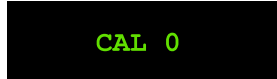

* Factory setting

Method of operation

Step	Description	Display and button operation
1	In weighing mode, click the CAL button. CAL 0 is displayed.	  
2	Click the SAMPLE button. The current weight value blinks.	 
3	Click the RE-ZERO button several times to select the weight value.	 Click several times 
4	Click the PRINT button. The weight value is registered and the display returns to CAL 0 .	 
5	Adjust the sensitivity by following the operations from step 4 in " 3-1-1. Sensitivity adjustment method ".	

Button operations used to change the weight value

These are the button operations used in steps 3 to 4.

Button	Description
	Switches to standby mode.
	Selects a weight value. For usable weights, refer to " Table 1. Weights usable for sensitivity adjustment ".
	Cancels the sensitivity adjustment and returns to weighing mode.
	Confirms the action and proceeds to the next step.

3-2. Self-check function

The weighing unit is equipped with a self-check function that automatically evaluates repeatability performance without using weights. (Electronically controlled load: ECL)

By controlling the internal mechanism, it is possible to create a state in which a minute load is applied to and removed from the sensor, and the repeatability of the weighing unit can be expressed numerically. Operation is possible even if a tare such as a jig is placed on the weighing pan.

Use the **ECL** button of WinCT-AD42121F when connecting with RS-232C and executing the self-check function. (Refer to "3-2-1. How to use the self-check function of WinCT-AD42121F".)



When connecting with RS-485 and executing the self-check function, send the "ECL" command to the weighing unit.

The measurement results are output in stages. (In the case of RS-232C, output together at the end.)

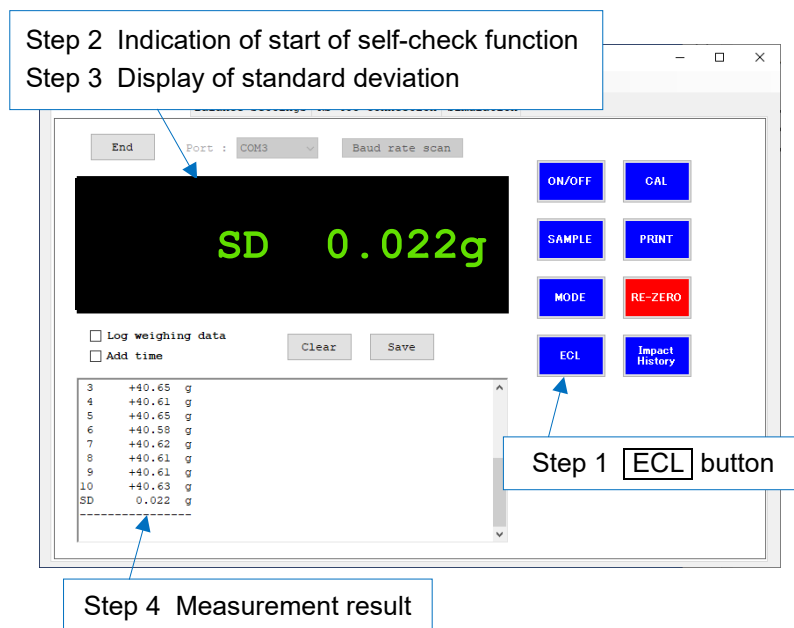
3-2-1. How to use the self-check function of WinCT-AD42121F

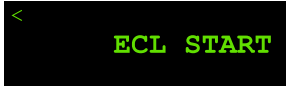
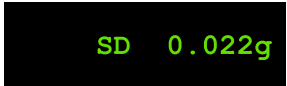

Method of operation (for RS-232C connection)

Step	Description	Display and button operation
1	In weighing mode, click the ECL button.	
2	ECL START is displayed and the self-check function starts.	
3	<p>After 10 weighing data results are displayed, the measured standard deviation (SD) is displayed.</p> <p>If the displayed standard deviation does not meet the specification^{*1} of the weighing unit, review the ambient conditions (drafts, vibration, static electricity, etc.).</p> <p>If the displayed standard deviation significantly exceeded the specification^{*1} of the weighing unit, there may be a fatal failure in the weighing unit. Request repairs.</p> <p>^{*1} Refer to Repeatability (Standard deviation) in "9. Specifications".</p>	
4	At the same time as results are displayed, the measurement results are collectively output from the weighing unit and displayed as a Log in WinCT-AD4212F.	
5	After END is displayed, the display returns to weighing mode.	

Example of measurement results

```
---ECL_RESULT---<TERM>
      A_&_D<TERM>
MODEL_____<TERM>
      AD4212F-10202<TERM>
S/N_____00000000<TERM>
ID_0000000000000000<TERM>
DATE__2023/06/26<TERM>
TIME___06:33:38<TERM>
RESULT_____<TERM>
  1_____+40.63__g<TERM>
  2_____+40.60__g<TERM>
  3_____+40.65__g<TERM>
  4_____+40.61__g<TERM>
  5_____+40.65__g<TERM>
  6_____+40.58__g<TERM>
  7_____+40.62__g<TERM>
  8_____+40.61__g<TERM>
  9_____+40.61__g<TERM>
 10_____+40.63__g<TERM>
SD_____0.022__g<TERM>
-----<TERM>
```

 : Space, ASCII 20h
<TERM> : Terminator, CR LF
CR : Carriage return, ASCII 0Dh
LF : Line feed, ASCII 0Ah

In the WinCT-AD4212F log recording window, (space) and <TERM> (terminator) are displayed blank.

3-3. Filter settings

The weighing speed (response characteristics) of the weighing unit can be changed by setting the filter. There are two types of filters available for filter settings: "Standard settings" and "Customize".

3-3-1. Standard settings

The weighing speed (response characteristics) can be set in three stages according to the disturbance such as drafts and vibration at the place where the weighing unit is installed.

Display	Weighing speed	Stability
[FAST]	Fast	Susceptible to vibration and drafts
[MID]	↑	↓
[SLOW]	Slow	Stable display



Method of operation

Step	Description	Display and button operation
1	In weighing mode, click the [MODE] button on WinCT-AD4212F to select the setting. (Choose one of [FAST], [MID], or [SLOW].)*1	Changes each time you click the [MODE] button

*1 The [MODE] button is disabled when the filter settings are set to "Customize".

3-3-2. Customize

- Weighing speed (response characteristics) can be set more finely than that with the standard settings. ("Zero tracking", "Stability band width", "Stability detect time", "Re-zero condition", "Averaging range", "Averaging time", "Digital filter")
- There are two types of setting methods: "Change using the [Balance Settings] tab" and "Change using the [Simulation] tab". When connecting via RS-485, use "Change using the [Balance Settings] tab".

(1) Change using the [Balance Settings] tab

You can select parameters in WinCT-AD4212F and write them to the weighing unit to change the filter settings of the weighing unit.

If the setting values to be changed have been determined, they can be easily changed using the [Balance Settings] tab.

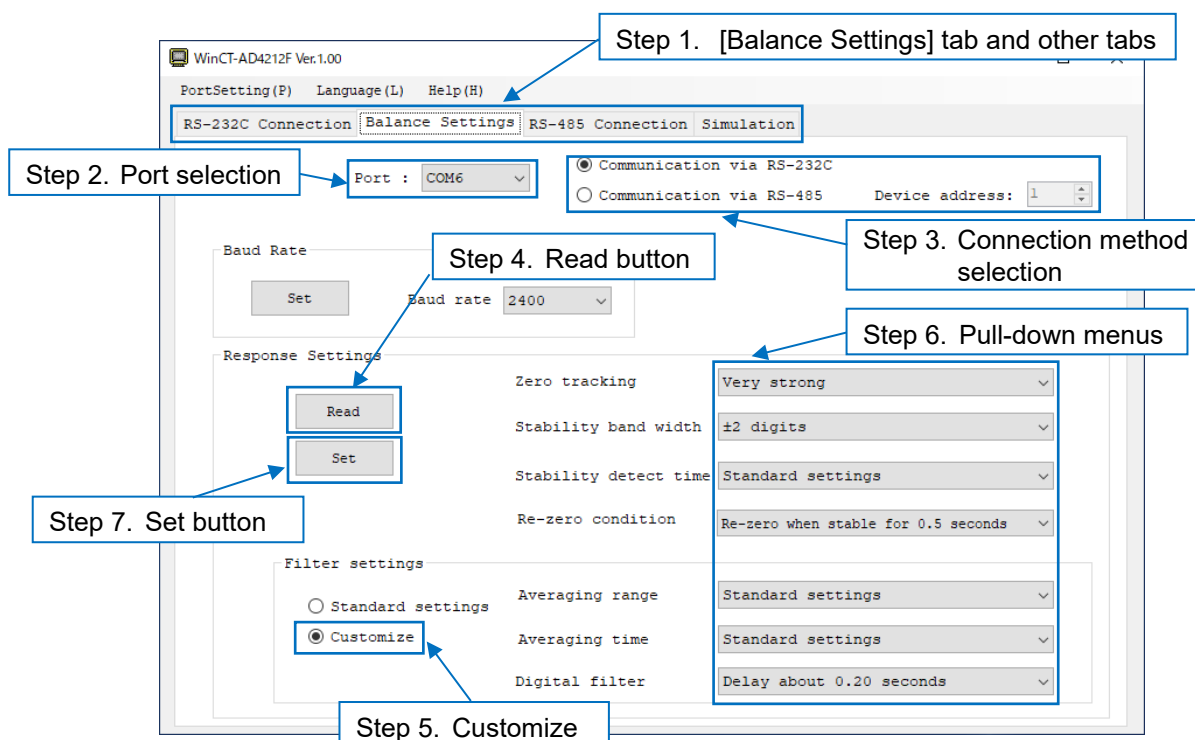

Step	Description
1	Click the [Balance Settings] tab.
2	Select a COM port.
3	Select a connection method. Specify the device address when connecting via RS-485.
4	Click the Read button in "Response Settings" to read the current settings from the weighing unit.
5	Select "Customize" to enable pull-down menus for averaging range, averaging time, and digital filter.
6	Select the desired settings from the pull-down menus.
7	Click the Set button in "Response Settings" to write the selected settings to the weighing unit.

(2) Change using the [Simulation] tab

You can graph the simulation results of all three methods (Current settings, Simulation 1, and Simulation 2) for weighing data captured in actual weighing work.

- ❑ In the simulation tab, it is possible to visually examine setting values to be changed and compare weighing data changes due to parameter changes.
- ❑ Each parameter of Simulation 1 and Simulation 2 can be changed arbitrarily, and they can be changed to suit the purpose for which the weighing unit is used.
- ❑ In the simulation tab, it is possible to save and read information on the weighing unit, parameter setting values, weighing data import results, and weighing data of each method in CSV format.







NOTICE

- ❑ Changes using the [Simulation] tab are available only when connected via RS-232C. When connecting via RS-485, use "(1) Change using the [Balance Settings] tab".
- ❑ Importing of weighing data may not work depending on the USB converter you are using.

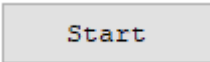
The screenshot displays the 'Simulation' tab in the WinCT-AD4212F software. Key components include:

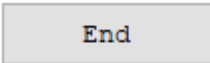
- Port selection:** A dropdown menu set to 'COM6'.
- Parameter name:** A table of simulation parameters for three methods: Current settings, Simulation 1, and Simulation 2.

Parameter	Current settings	Simulation 1	Simulation 2
Readability	0.1g	0.1g	0.1g
Response settings	FAST	MID	SLOW
Zero tracking	Very stror	Very stror	Very stror
Stability band width	±2 digits	±2 digits	±2 digits
Stability detect time	Standard	Standard	Standard
Re-zero condition	Re-zero w/	Re-zero w/	Re-zero w/
Customize	<input type="checkbox"/> Enable	<input type="checkbox"/> Enable	<input type="checkbox"/> Enable
Averaging range	Standard	Standard	Standard
Averaging time	Standard	Standard	Standard
Digital filter	Delay abou	Delay abou	Delay abou
- Method name:** Checkboxes for 'Current settings', 'Simulation 1', and 'Simulation 2'.
- Display screen:** A digital scale showing '2220.2 g'.
- Graph:** A line graph showing 'Weighing Data (g)' on the y-axis (0 to 2500) and 'Time (sec)' on the x-axis (3 to 8). It plots 'Weighing data' and 'Stability detection' for three methods: Current settings (blue), Simulation 1 (red), and Simulation 2 (green).
- Graph axis settings:** Input fields for X-axis (3, 8) and Y-axis (0, 2500).
- RE-ZERO:** A red button for recalibrating the scale.

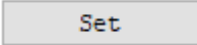
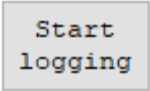
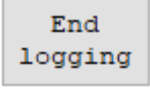
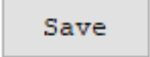
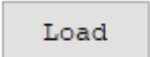
Item	Description
Port selection	Selects the port to connect to.
	Establishes a connection between the weighing unit and WinCT-AD4212F. After the connection is established, it changes to the  button.
	Disconnects the connection between the weighing unit and WinCT-AD4212F. After the connection is disconnected, it changes to the  button. After the connection is disconnected, the connection cannot be established for about 20 seconds.
Display screen	Displays current weighing data.
	Zeros the weighing data.
Method name	Method names. Check the box next to the method you want to graph.
Parameter name	Modifiable parameter names.
	Displays a detailed description of each parameter.
	Writes the parameters of each method to the weighing unit.
	Starts loading the weighing data. After establishing the connection between the weighing unit and WinCT-AD4212F, it will be enabled in about 10 seconds. Loading takes up to 5 minutes.
	Ends loading of weighing data.
	Saves the weighing unit information, parameter settings, weighing data import results, and weighing data for each method in CSV format.
	Loads the CSV file saved with the save button. By using the loaded weighing data, you can use previously acquired weighing data and parameter settings.
Graph	Displays weighing data for each checked method. The graph size changes according to the window size of WinCT-AD4212F.
Graph axis settings	By entering numerical values, you can change the maximum and minimum values of the axis of the graph.

The screenshot shows the WinCT-AD4212F Ver.1.00 software interface. The main window is titled "Weighing Data Simulator" and has tabs for "PortSetting (P)", "Language (L)", and "Help (H)". Below the tabs are "RS-232C Connection", "Balance Settings", "RS-485 Connection", and "Simulation".

Step 1. Select port: The "Port" dropdown menu is set to "COM6".

Step 2. Start button: The "Start" button is highlighted.

Step 3. RE-ZERO button: A red "RE-ZERO" button is highlighted below the digital display.

Step 4. Start logging button: The "Start logging" button is highlighted.

Step 7. End logging button: The "Load" button is highlighted.

Step 8. Method check: The "Simulation" tab is active, showing a table of parameters for "Current settings", "Simulation 1", and "Simulation 2".

	Current settings	Simulation 1	Simulation 2
Readability	0.1g	0.1g	0.1g
Response settings	FAST	MID	SLOW
Zero tracking	Very stror	Very stror	Very stror
Stability band width	±2 digits	±2 digits	±2 digits
Stability detect time	Standard :	Standard :	Standard :
Re-zero condition	Re-zero w/	Re-zero w/	Re-zero w/
Customize	<input type="checkbox"/> Enable	<input type="checkbox"/> Enable	<input type="checkbox"/> Enable
Averaging range	Standard :	Standard :	Standard :
Averaging time	Standard :	Standard :	Standard :
Digital filter	Delay abou	Delay abou	Delay abou

Step 9. Change the display range of the graph: The graph shows "Weighing Data(g)" vs "Time(sec)". The Y-axis has a scale from 0 to 2000. The X-axis has a scale from 3 to 8. The graph shows three curves (blue, red, green) representing different simulation runs. The "RE-ZERO" button is highlighted.

Step 10. Set buttons: The "Set" buttons for "Current settings", "Simulation 1", and "Simulation 2" are highlighted.

The digital display shows "2220.2 g".

The "Start logging" button is highlighted.

The "Load" button is highlighted.

The "X:" input fields are set to 3, 8, and 0. The "Y:" input fields are set to 0 and 2500.

Step	Description
1	Select the port to connect to.
2	Click the <input type="button" value="Start"/> button. The parameters of the weighing unit are read out and the weighing data is displayed on the display screen.
3	Click the <input type="button" value="RE-ZERO"/> button if necessary to zero the display screen.
4	Click the <input type="button" value="Start logging"/> button*1. *1 The <input type="button" value="Start logging"/> button is enabled about 10 seconds after establishing the connection between the weighing unit and WinCT-AD4212F.
5	Loading the weighing data starts. The loaded weighing data is graphed. Loading takes up to 5 minutes.
6	Perform weighing work.
7	Click the <input type="button" value="End logging"/> button. Loading of weighing data ends.
8	Check the box(es) next to the method name(s) you want to graph. When checked, each parameter can be selected. Changes to parameters are instantly reflected in the graph. Note "Current settings" parameters cannot be changed on WinCT-AD4212F. When you click the <input type="button" value="Reload"/> button, or click the <input type="button" value="End"/> button and then click the <input type="button" value="Start"/> button again, the settings of the weighing unit will be read and the settings will be updated.
9	You can change the display range of the graph by changing the X-axis maximum / minimum and Y-axis maximum / minimum values. The graph size changes according to the window size of WinCT-AD4212F.
10	Click the <input type="button" value="Set"/> button for each method you want to change the settings of the weighing unit.

Parameter descriptions

This section describes the modifiable functions that affect the weighing data.

(1) Zero tracking

This function keeps the display at zero by tracking the zero point. When the display is zero, it keeps the display at zero by increasing the zero track if fluctuating. It can be set regardless of filter settings. When performing minute weighing, note that it may not be possible to weigh unless the zero track is weakened.

Set value	Description
OFF	No zero tracking.
Normal	± 1 digit* ¹ If the fluctuation is within 1 second, the display will remain zero.
Strong	± 1 digit* ¹ If the fluctuation is within 0.5 seconds, the display will remain zero.
Very strong*	± 1 digit* ¹ If the fluctuation is within 0.2 seconds, the display will remain zero.

*¹ For digits, refer to "(7) Digit".

* Factory setting

(2) Stability band width and stability detect time

When the weighing data is less than a certain range (stability band width) and a certain amount of time (stability detection time) has passed, it is judged to be stable. When it is judged to be stable, the WinCT-AD4212F displays a circle stabilization indicator and adds "ST" to the weighing data output. If unstable, the circle turns off and "US" is added to the weighing data output.

● Output format

Stable

S	T	,	+	0	0	1	2	.	3	4	5	□	□	g	CR	LF
---	---	---	---	---	---	---	---	---	---	---	---	---	---	---	----	----



Unstable

U	S	,	+	0	0	0	5	.	4	3	2	□	□	g	CR	LF
---	---	---	---	---	---	---	---	---	---	---	---	---	---	---	----	----

□ : Space, ASCII 20h

CR : Carriage return, ASCII 0Dh

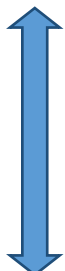
LF : Line feed, ASCII 0Ah

Stability band width	Stability detection criteria	Stability detect time	Stability detection criteria
± 1 digit* ¹	 Strict Loose	Standard setting* ² , *	Depends on model and response characteristics
± 2 digits* ¹ , *		0.1 seconds	 Loose Strict
± 3 digits* ¹		0.2 seconds	
± 4 digits* ¹		0.3 seconds	
± 5 digits* ¹		0.4 seconds	
± 6 digits* ¹		0.5 seconds	
± 7 digits* ¹		0.6 seconds	
± 8 digits* ¹		0.7 seconds	
± 9 digits* ¹		0.8 seconds	
± 10 digits* ¹		0.9 seconds	

* Factory setting

*¹ For digits, refer to "(7) Digit".

*² Refer to "(8) Setting values in standard settings" for setting values when standard settings are used.

(3) Re-zero condition

This function changes the execution condition when receiving a re-zero instruction to set the display value to zero.

If it is set to "Re-zero when stable for 0.2 seconds", re-zero will be executed after confirming that the weighing data has stabilized for 0.2 seconds after receiving an external instruction to re-zero.

By changing the re-zero execution conditions, it is possible to change the time until re-zero is performed, and to execute re-zero even in an unstable state.

● Setting

Re-zero condition
Re-zero immediately regardless of the stability status
Re-zero immediately when stable
Re-zero when stable for 0.2 seconds
Re-zero when stable for 0.3 seconds
Re-zero when stable for 0.4 seconds
Re-zero when stable for 0.5 seconds*
Re-zero when stable for 0.6 seconds
Re-zero when stable for 0.7 seconds
Re-zero when stable for 0.8 seconds
Re-zero when stable for 0.9 seconds

* Factory setting

(4) Averaging range

Averaging starts when the change in the weighing data is within the "variation range". When the averaging width is large, such as when filling a very small amount, the response may be slow because the averaging range is not exceeded. In that case, reducing the averaging range can speed up the response at very small amounts. On the other hand, if the averaging range is small, it becomes vulnerable to disturbances such as drafts. In that case, increase the averaging range.

● Set value

Averaging range	Approximate for each model		
	AD-4212F-6203D	AD-4212F-10202	AD-4212F-22001
Standard settings*1, *	-	-	-
Level 1 (Narrow)	Approx. 5 digits*2	Approx. 5 digits*2	Approx. 5 digits*2
Level 2	Approx. 10 digits*2	Approx. 10 digits*2	Approx. 10 digits*2
Level 3	Approx. 20 digits*2	Approx. 25 digits*2	Approx. 30 digits*2
Level 4	Approx. 50 digits*2	Approx. 60 digits*2	Approx. 70 digits*2
Level 5	Approx. 100 digits*2	Approx. 120 digits*2	Approx. 130 digits*2
Level 6 (Wide)	Approx. 160 digits*2	Approx. 180 digits*2	Approx. 200 digits*2
Always perform averaging	-	-	-

* Factory setting

*1 Refer to "(8) Setting values in standard settings" for setting values when standard settings are used.

*2 For digits, see "(7) Digit".

● Change in response when weighing very small amount due to averaging range (Example of AD-4212F-6203D)

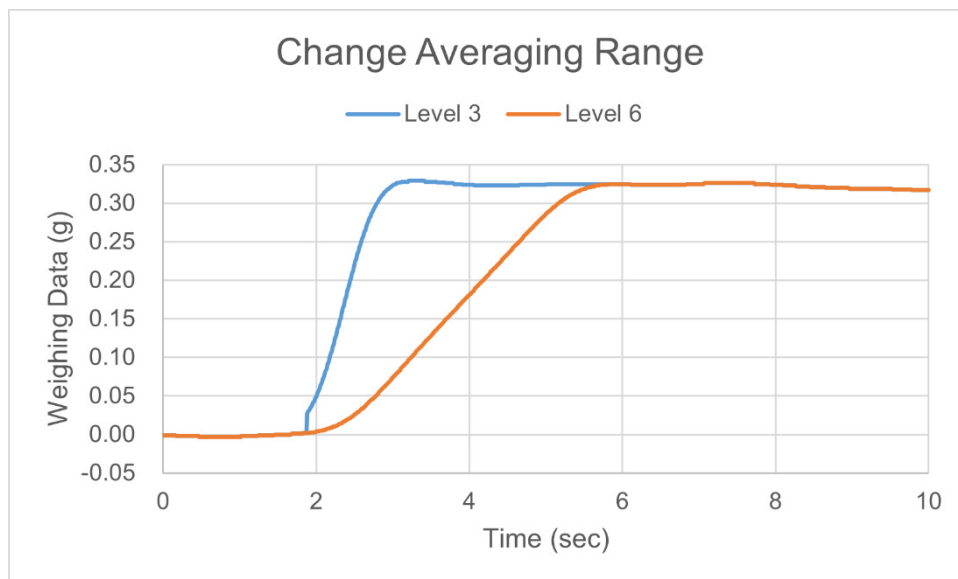

(5) Averaging time

Averaging starts when the change in weighing data falls within the "variation range", and when the and when averaging is performed until the "averaging time", the data subsequently becomes a moving average. This setting allows you to set the maximum time for averaging.

● Setting

Averaging time
Standard settings*1, *
No averaging
0.5 seconds
1.0 second
1.5 seconds
2.0 seconds
2.5 seconds
3.0 seconds

* Factory setting

*1 Refer to "(8) Setting values in standard settings" for setting values when standard settings are used.

● **Change in weighing data due to averaging time (example for AD-4212F-6203D)**

- Averaging starts when the change in weighing data falls within the averaging range. If the weighing data change exceeds the averaging range, averaging will not occur.
- If you set a long averaging time, it will become less sensitive to changes after the weighing data falls within the averaging range, making it easier to stabilize.

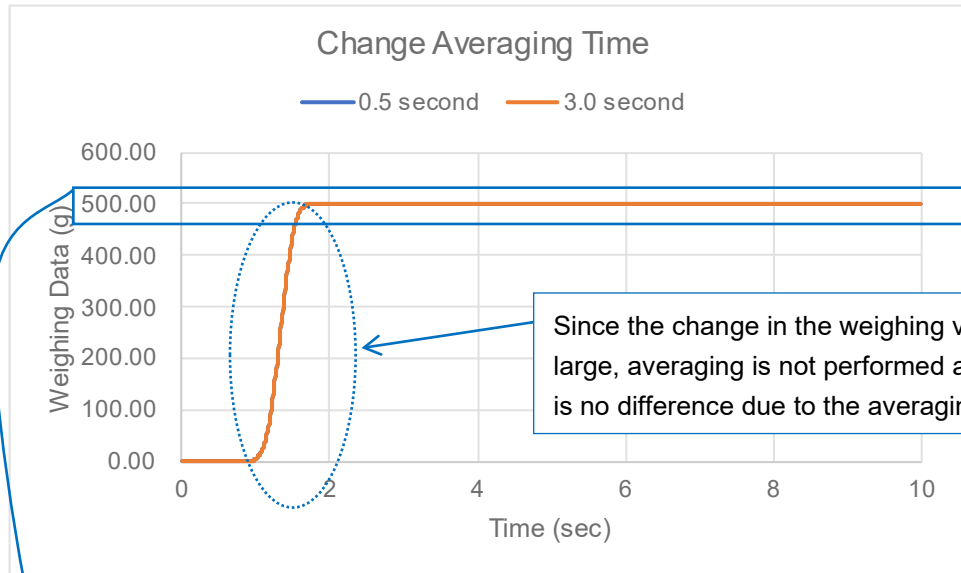

Expansion

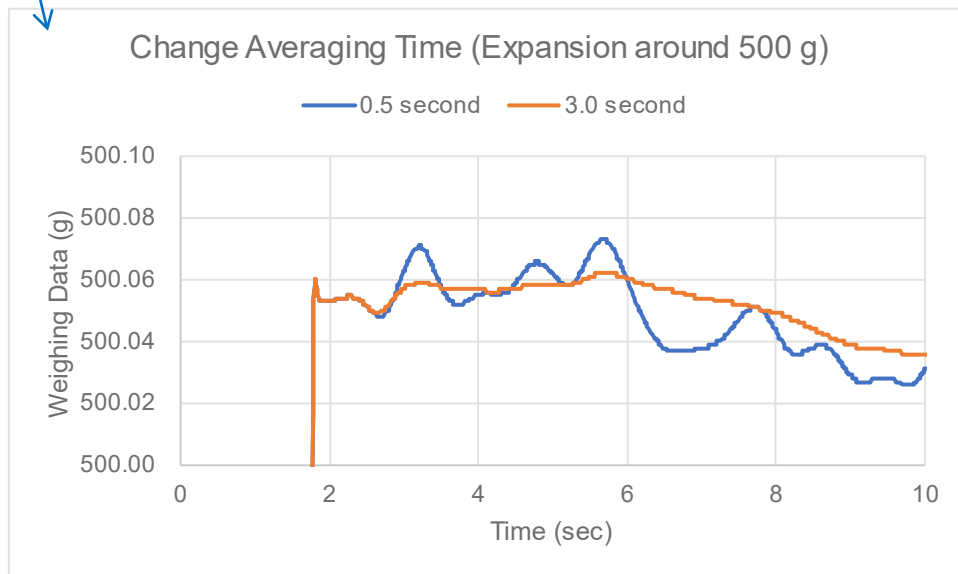

(6) Digital filter





Since the digital filter is always running, it affects the overall movement of the weighing data (weighing speed (response characteristics), stability).

The setting value is a guideline for the time it takes for the weighing data to change to near the final value after placing the object to be weighed.

(After that, the stabilization time to confirm the weighing data varies depending on the situation.)

If you want to increase the weighing speed (response characteristics), set a smaller setting value. If stability is more important than weighing speed (response characteristics), set a larger value.

● Setting value

Digital filter	Weighing speed	Stability
Delay approx. 0.20 seconds*	Fast   Slow	Susceptible to vibration and drafts   Stable display
Delay approx. 0.30 seconds		
Delay approx. 0.40 seconds		
Delay approx. 0.45 seconds		
Delay approx. 0.50 seconds		
Delay approx. 0.55 seconds		
Delay approx. 0.60 seconds		
Delay approx. 0.65 seconds		
Delay approx. 0.75 seconds		
Delay approx. 0.80 seconds		
Delay approx. 0.90 seconds		
Delay approx. 1.10 seconds		
Delay approx. 1.50 seconds		
Delay approx. 1.80 seconds		
Delay approx. 2.00 seconds		
Delay approx. 2.50 seconds		
Delay approx. 2.80 seconds		

* Factory setting

● Change in weighing data due to digital filter (example for AD-4212F-6203D)

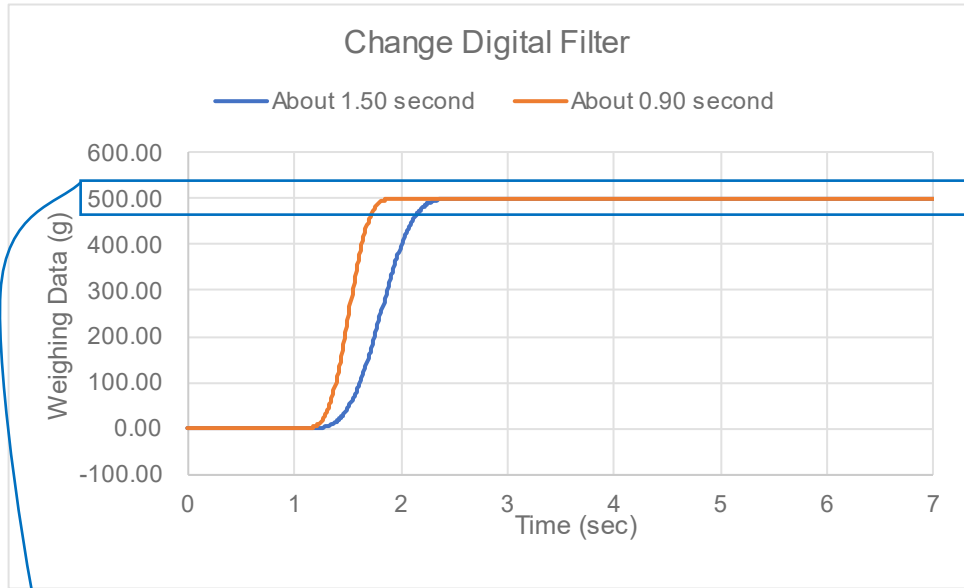

Expansion

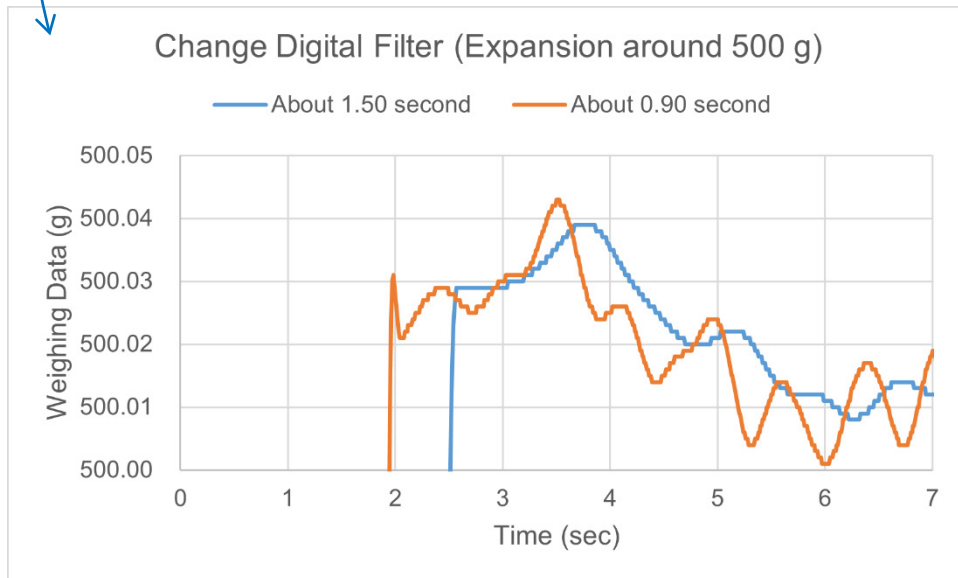

(7) Digit

The digits represent the readability value.

E.g. 1) If the readability of the AD4212F-6203D is 0.001 g, 0.001 g = 1 digit.

If one display digit is blanked out and the readability is 0.01 g, 0.01 g = 1 digit.

If two display digits are blanked out and the readability is 0.1 g, 0.1 g = 1 digit.

E.g. 2) AD4212F-6203D automatically changes the readability digit when it exceeds 510 g in smart range.

Below 510 g, readability 0.001 g = 1 digit.

Above 510 g, readability 0.01 g = 1 digit.

(8) Setting values in standard settings

Model	Readability	Response characteristics	Stability detect time	Averaging range	Averaging time	Digital filter
AD-4212F-6203D	0.001 g	FAST	0.30 seconds	Approx. 0.010 g	3.0 seconds	Delay approx. 0.90 seconds
		MID	0.40 seconds	Approx. 0.110 g	5.0 seconds	Delay approx. 1.50 seconds
		SLOW	0.60 seconds	Approx. 0.160 g	5.0 seconds	Delay approx. 2.00 seconds
	0.01 g	FAST	0.08 seconds	Approx. 0.10 g	0.8 seconds	Delay approx. 0.50 seconds
		MID	0.16 seconds	Approx. 0.20 g	0.8 seconds	Delay approx. 0.90 seconds
		SLOW	0.32 seconds	Approx. 0.35 g	0.8 seconds	Delay approx. 1.80 seconds
	0.1 g	FAST	0.08 seconds	Approx. 0.1 g	0.4 seconds	Delay approx. 0.20 seconds
		MID	0.16 seconds	Approx. 0.1 g	0.4 seconds	Delay approx. 0.50 seconds
		SLOW	0.32 seconds	Approx. 0.2 g	0.8 seconds	Delay approx. 0.90 seconds
AD-4212F-10202	0.01 g	FAST	0.08 seconds	Approx. 4.00 g	0.8 seconds	Delay approx. 0.50 seconds
		MID	0.16 seconds	Approx. 6.00 g	0.8 seconds	Delay approx. 0.90 seconds
		SLOW	0.32 seconds	Approx. 13.00 g	0.8 seconds	Delay approx. 1.80 seconds
	0.1 g	FAST	0.08 seconds	Approx. 4.0 g	0.8 seconds	Delay approx. 0.20 seconds
		MID	0.16 seconds	Approx. 4.0 g	0.8 seconds	Delay approx. 0.50 seconds
		SLOW	0.32 seconds	Approx. 7.0 g	0.8 seconds	Delay approx. 0.90 seconds
AD-4212F-22001	0.1 g	FAST	0.08 seconds	Approx. 23.0 g	0.8 seconds	Delay approx. 0.50 seconds
		MID	0.16 seconds	Approx. 34.0 g	0.8 seconds	Delay approx. 0.90 seconds
		SLOW	0.32 seconds	Approx. 67.0g	0.8 seconds	Delay approx. 1.80 seconds
	1 g	FAST	0.08 seconds	Approx. 19 g	0.8 seconds	Delay approx. 0.20 seconds
		MID	0.16 seconds	Approx. 21 g	0.8 seconds	Delay approx. 0.50 seconds
		SLOW	0.32 seconds	Approx. 38 g	0.8 seconds	Delay approx. 0.90 seconds

3-4. Changing the baud rate using WinCT-AD4212F

Method of operation

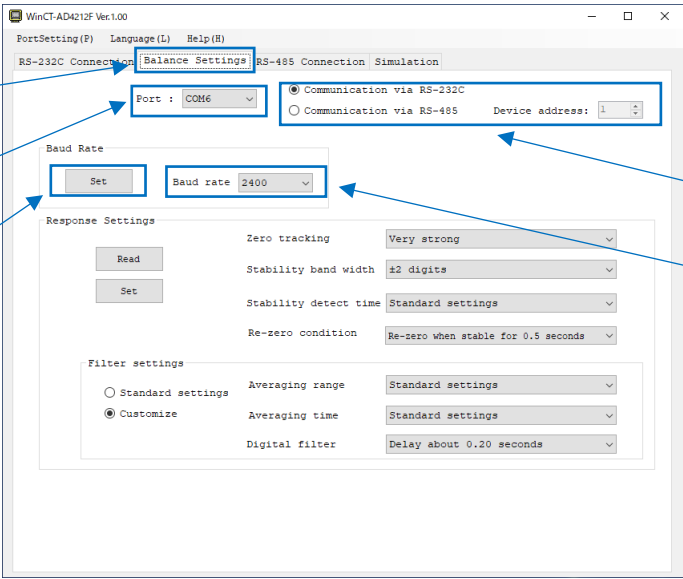
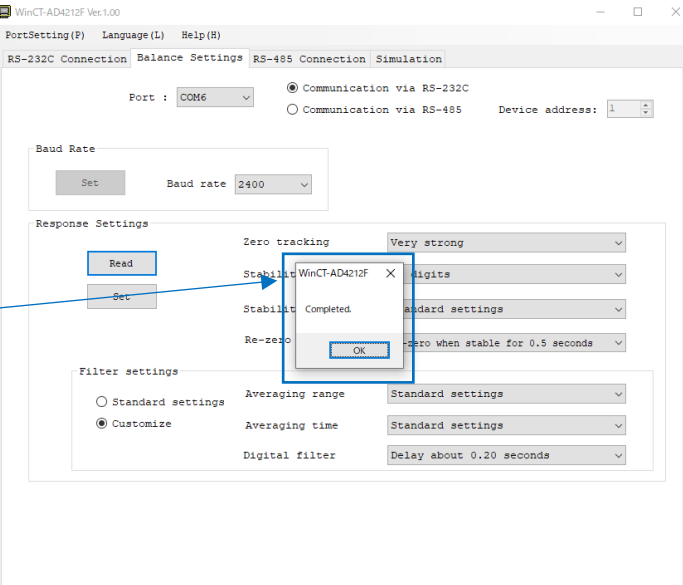
Step	Description
1	Click the [Balance Settings] tab.
2	Select a COM port.
3	Select a connection method. Specify the device address when connecting via RS-485.
4	Select the baud rate to be used and click the Set button. (Factory setting: 2400)  [Balance Settings] tab Port selection Set button Connection method selection Baud rate
5	"Completed." appears when the setting is complete.  "Completed." display

3-5. Multiple connections (RS-485)

With WinCT-AD4212F, it is possible to check the operation (display of weighing data, re-zero, sensitivity adjustment, etc.) of multiple weighing units connected in a daisy chain via RS-485.

Wiring

Use the accessory RS-485 interface for daisy chain (accessory: AD4212F-29) and accessory cable (AX-KO7622-200) to daisy chain the weighing unit via RS-485.

(Refer to "6-2. RS-485" for details on how to attach the RS-485 interface for daisy chain and how to make daisy chain connections.)

Use the accessory cable (AX-KO7522-500) to connect to a PLC.

(Refer to "6-2-2. Pin position when using AX-KO7522-500" for pin position.)

For connection to a PC, use a commercially available RS-485 to USB converter, etc.

Setting

Set each connected weighing unit to a different device address.

(Refer to "6-2. RS-485".)

Method of operation

Step	Description
1	Select the number of weighing units to be connected. (Do not exceed the number of units actually connected.)
2	Select the device address for each unit. (Do not set anything other than the address of the actually connected device. Do not set the same device address more than once.)
3	Select the COM port of the connected PC.
4	Click the Start button.
5	The Start button changes to the End button. The weighing data of the weighing unit set to each device address is displayed on each display screen.
6	Set the device address of the weighing unit you want to operate.
7	Click the individual buttons to operate the weighing unit individually.

The screenshot shows the WinCT-AD4212F Ver.1.00 software interface. The window title is "WinCT-AD4212F Ver.1.00". The menu bar includes "PortSetting (P)", "Language (L)", and "Help (H)". The main area has tabs for "RS-232C Connection", "Balance Settings", "RS-485 Connection", and "Simulation".

Callouts point to the following elements:

- Step 1. Number of units connected:** Points to the "Number of Devices" spinner set to 4.
- Step 2. Device addresses:** Points to the "Device Address" list on the left, which contains addresses 1, 2, 3, and 4.
- Step 3. COM port:** Points to the "Port" dropdown menu set to "COM9".
- Step 4. Start button:** Points to the "Start" button.
- Step 6. Device address setting:** Points to the "Device Address" spinner set to 1.
- Step 7. Buttons:** Points to a panel of control buttons: "ON/OFF", "CAL", "SAMPLE", "PRINT", "MODE", and "RE-ZERO".

The main display area shows a list of weighing units with their addresses and weights:

Device Address	Weight	Unit
1	2000.0	g
2	0.0	g
3	0.0	g
4	0.0	g





4. Smart Range Function

For AD-4212F-6203D, there are two types of range: the standard range and the precision range (higher resolution).

The range can switch automatically depending on the display value. In addition, even when a heavy container is placed on the weighing pan, weighing with the precision range can be performed by returning the display value to zero with the R command.

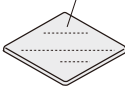
Also, the range can be fixed to the standard range by switching the readability with the SMP command.

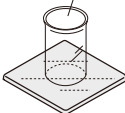
Operation method (Display example for AD-4212F-6203D)

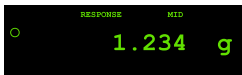
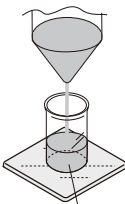
Step	Description	Display	Weighing operation
1	Send the "R" command. (Weighing with the precision range starts.)	 Precision range	Weighing pan 
2	Place a container on the weighing pan. (The display value has exceeded the precision range, so the range switches to the standard range.)	 Standard range	Container 
3	Send the "R" command. (The range switches to the precision range.)	 Precision range	
4	Place a sample in the container. (The display value is within the precision range, so weighing with the precision range can be performed.)	 Precision range	 Sample

Precision range / Standard range

Model	Type of range	Weighing range	Readability
AD-4212F-6203D	Precision range*, *1	0 g to 510 g	0.001 g
	Standard range	510 g ~	0.01 g

* Factory setting

*1 The readability will automatically switch from 0.001 g to 0.01 g when the display value exceeds 510 g, but by sending the R command, weighing can be done in 0.001 g readability from that point up to 510 g.

5. Impact Shock Detection Function

The weighing unit is equipped with a function to detect impact shocks applied to the mass sensor. By lowering the impact level at the time of loading, not only can variation in weighing data be mitigated, but the risk of failure of the mass sensor can also be reduced.

In particular, when the weighing unit is incorporated into a production line, etc., and weighing is performed by an automated machine, etc., the weighing sensor may receive unexpected impacts. We recommend that you reduce the shock level as much as possible while checking the indicator lamp (red) or the shock indicator of WinCT-AD4212F when designing automated machines, etc.

The impact level is displayed in 5 levels from level 0 to level 4 by the indicator lamp (red).

Impact level	Blinking of indicator lamp (red)	WinCT-AD4212F Shock indicator ^{*1}	Description
0	No blinking	No display	Safe
1			Caution
2			Caution: Alleviate impact shocks
3	Blinking (2 seconds)		Warning: Do not apply any more impact shocks
4			Danger: Sensor may be damaged

^{*1} The shock indicator display lasts for about 4 seconds after detecting an impact.

5-1. Recording impact history

Impacts of impact level 3 or higher are automatically stored in the weighing unit with date and time (up to 50 instances).

NOTICE

- If the number of recorded instances exceeds 50, the recorded data with the lowest impact level will be overwritten.
- The recorded impact history cannot be deleted.
- Impact data where the weighing unit is not energized (during transport, etc.) is not recorded.



5-2. Outputting impact history

The stored impact history can be output by sending a specified command to the weighing unit or by operating from WinCT-AD4212F.

Output by command

Sending the "?SA" command to the weighing unit outputs the stored impact data all at once.

Operation from WinCT-AD4212F

Step	Description	Display and button operation
1	Connect with WinCT-AD4212F via RS-232C and display weighing data. (Refer to "3. Operation of WinCT-AD4212F".)	
2	When you click the Impact History button in WinCT-AD4212F, the impact history is output from the weighing unit and displayed as a log in WinCT-AD4212F.	

Impact history output example

```
2023/03/27,05:15:41,SHOCK_LV,4<TERM>
2023/03/27,05:15:48,SHOCK_LV,4<TERM>
2023/03/27,05:16:00,SHOCK_LV,4<TERM>
2023/03/27,05:16:09,SHOCK_LV,3<TERM>
2023/03/27,05:16:20,SHOCK_LV,4<TERM>
2023/03/27,05:16:25,SHOCK_LV,3<TERM>
```

_: Space, ASCII 20h
 <TERM>: Terminator, C_R L_F
 C_R: Carriage return, ASCII 0Dh
 L_F: Line feed, ASCII 0Ah

In the WinCT-AD4212F log recording window, _ (space) and <TERM> (terminator) are displayed blank.

The date display order is fixed to "Year/Month/Day".

6. Communication Specifications

The weighing unit is capable of two-way communication via either RS-232C (using an accessory cable AX-KO3590-1000) or RS-485 (using an accessory cable AX-KO7522-500, and for daisy chain connection, AX-KO7622-200). The weighing unit is data circuit terminating equipment (DCE).

6-1. RS-232C

6-1-1. RS-232C specification

Transmission system	EIA RS-232C
Transmission form	Asynchronous, bidirectional
Transmission rate	Approx. 3 times/second to 100 times/second (Approx. 13 times/second*) (when set to continuous output mode)
Data format	Baud rate* ¹ 600 bps to 115200 bps (2400 bps*) Data bits 7 bits Parity EVEN Stop bit 1 bits Code ASCII Terminator <CR><LF>
Data output mode	Command mode, continuous output mode*

* Factory setting

*¹ To change the settings, use commands by RS-232C or RS-485. (Refer to "6-4. Command" for details.)

■ Relation between baud rate and transmission rate of weighing data (in continuous output mode)

Baud rate	Transmission rate of weighing data
600 bps	Approx. 3 times / second
1200 bps	Approx. 7 times / second
2400 bps	Approx. 13 times / second
4800 bps	Approx. 25 times / second
9600 bps	Approx. 50 times / second
19200 bps	Approx. 100 times / second
28800 bps	Approx. 100 times / second
38400 bps	Approx. 100 times / second
115200 bps	Approx. 100 times / second

6-1-2. AX-KO3590-1000 pin position

Pin position of RS-232C cable (D-Sub 9-pin side female)

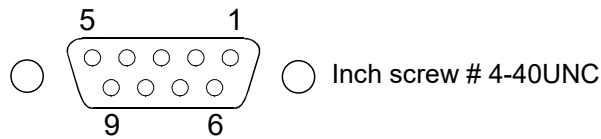

Pin No.	Signal name	Direction	Description
1	(Vs)	-	Internal use* ¹ (Power supply GND terminal for external equipment)
2	TXD	Output	Transmit data
3	RXD	Input	Received data
4	-	-	N.C.
5	SG	-	Signal ground
6	DSR	Output	Data set ready
7	RTS	Input	Request to send
8	CTS	Output	Permission to send
9	(Va)	-	Internal use* ² (Power supply output terminal for external equipment)

CTS and RTS are connected inside the weighing unit. Communication is possible by connecting TXD, RXD, and SG.

***1, *2** When connecting to an external device such as a PLC, do not use the "internal use" signal lines for wiring.

6-2. RS-485

With RS-485, by changing the device address of each weighing unit, you can connect RS-485 signal lines in a daisy chain and exchange commands with individual weighing units. (Maximum 31 units.) Also, by using an ON/OFF switch, a terminating resistor (100 Ω) can be connected, so there is no need to connect an external terminating resistor to the terminating unit.

To connect the weighing unit in a daisy chain, an RS-485 interface for daisy chain (accessory: AD4212F-29) is required. Attach it to an individual weighing unit while referring to "6-2-5.How to install the RS-485 interface for daisy chain".

If only one unit is connected by RS-485, no RS-485 interface for daisy chain is required.

To connect the weighing unit and a PC or PLC, use an accessory cable AX-KO7522-500. To connect one weighing unit to another, use an accessory cable AX-KO7622-200.

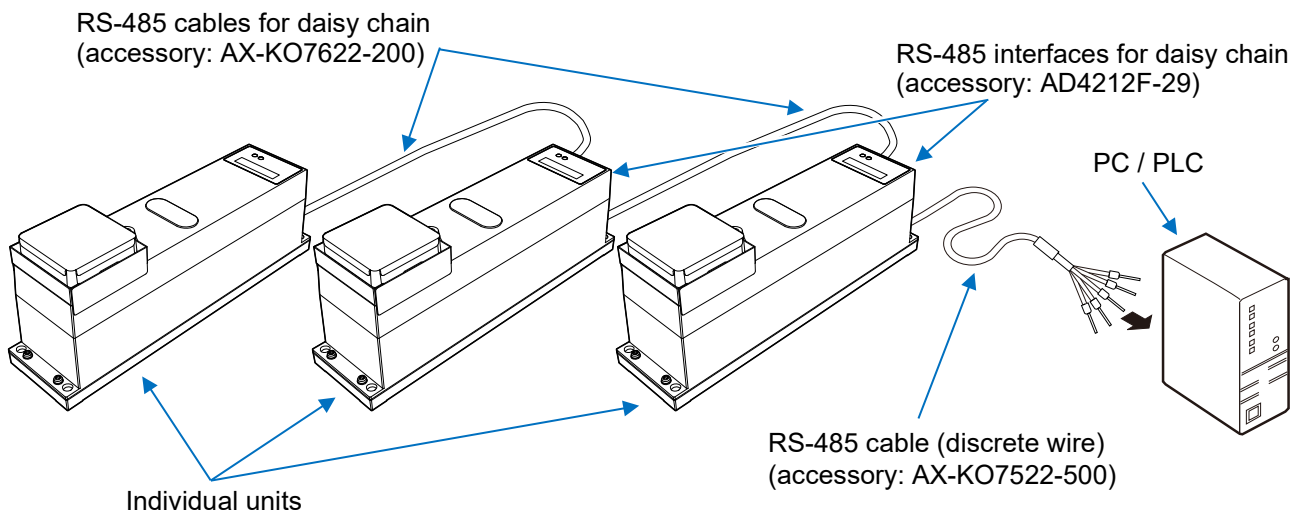

6-2-1. RS-485 specifications

Transmission system	EIA RS-485
Transmission form	Asynchronous (asynchronous), bidirectional
Transmission rate	Approx. 3 times/second to 100 times/second (Approx. 13 times/second*)
Datal format	Baud rate* ¹ 600 bps to 115200 bps (2400 bps*) Data bits 7 bits Parity EVEN Stop bit 1 bit Code ASCII Terminator <CR><LF>
Data output mode	Command mode only
Device address	00* to 99
Terminating resistor	None (open)*, 100 Ω

* Factory setting

*¹ To change the settings, use commands by RS-232C or RS-485. (Refer to "6-4. Command" for details.)

6-2-2. Pin position when using AX-KO7522-500

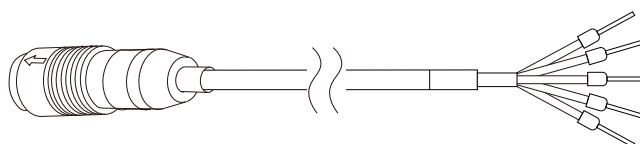

Lead wire	Signal name	Direction	Description
Yellow	DC+	Input / output	Power supply (12 VDC)* ¹
Yellow / White	GND	Input / output	Power supply (0V)
Blue	DATA+	Input / output	RS-485 signal line
Blue / White	DATA-	Input / output	RS-485 signal line
Black	FG	-	Frame ground

*¹ Supplies power to the weighing unit. 12 V is output when power is supplied directly to the weighing unit with the included AC adapter.

CAUTION

- DC+ (yellow) and GND (yellow / white) are connected to the power supply +12 V and 0 V of the weighing unit. When supplying power to the weighing unit, be careful not to make a mistake in the voltage, as this may lead to malfunction of the weighing unit or fire.
Also, when the power is on, do not allow the terminals of the discrete wires to come into contact with each other or surrounding objects, and do not touch them with your hands. Doing so may result in malfunction of the weighing unit or electric shock.

6-2-3. Changing device address and terminating resistor settings

The device address of the weighing unit can be changed by two methods: change by rotary switch and change by command. (If the device address is set by both the rotary switch and command, the rotary switch setting takes precedence.)

Also, the RS-485 terminating resistance can be changed between none (open) and 100 Ω using an ON/OFF switch. Turn the ON/OFF switch of the weighing unit at the end of the daisy chain connection to ON.

Change device address by rotary switch and terminating resistance change by ON/OFF switch

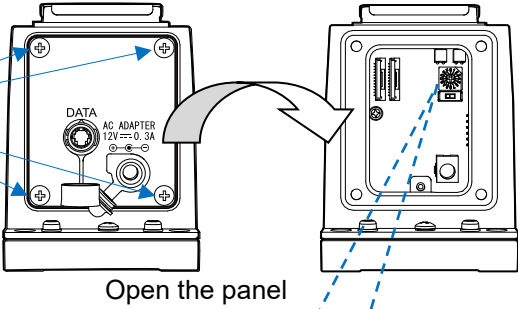
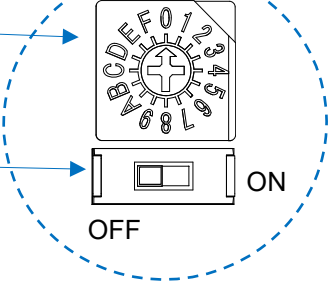
Step	Description												
1	<p>Use a screwdriver to remove the screws (4 places) on the back of the weighing unit and open the panel.</p> <p>Screws on the back (4 places)</p>  <p>Open the panel</p>												
2	<p>Operate the rotary switch and ON/OFF switch on the board to change the setting.</p> <p>Rotary switch</p> <table border="1"> <thead> <tr> <th>Set value</th> <th>Device address</th> </tr> </thead> <tbody> <tr> <td>0</td> <td>Not added</td> </tr> <tr> <td>1 to F</td> <td>01 to 15</td> </tr> </tbody> </table> <p>ON/OFF switch</p> <table border="1"> <thead> <tr> <th>Set value</th> <th>Terminating resistor</th> </tr> </thead> <tbody> <tr> <td>OFF(Left)</td> <td>None(open)</td> </tr> <tr> <td>ON(Right)</td> <td>100 Ω</td> </tr> </tbody> </table> 	Set value	Device address	0	Not added	1 to F	01 to 15	Set value	Terminating resistor	OFF(Left)	None(open)	ON(Right)	100 Ω
Set value	Device address												
0	Not added												
1 to F	01 to 15												
Set value	Terminating resistor												
OFF(Left)	None(open)												
ON(Right)	100 Ω												

Change by command

Send the “DAD**” command to the weighing unit. (In the ** part, enter the number you want to set from 00 to 99.)

6-2-4. Checking device address

Sending the “?DAD” command to the weighing unit outputs the set device address.

If both the rotary switch and command are set, the rotary switch setting takes precedence.

Rotary switch	Command settings	Device address	“?DAD” response
0	00	00 (none)	DAD,00
1 to 15	—	01 to 15	DAD,01 to 15
0	01~99	01 to 99	DAD,01 to 99

6-2-5. How to install the RS-485 interface for daisy chain

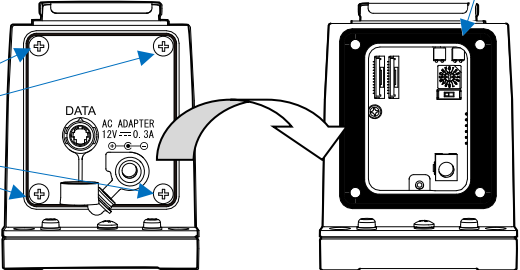
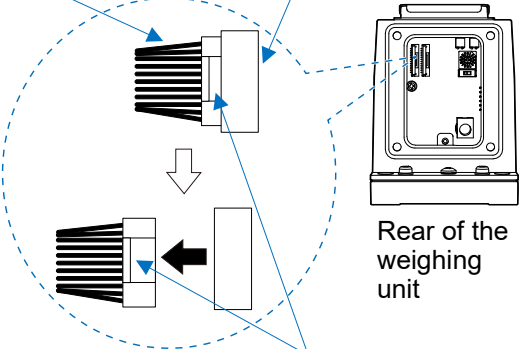
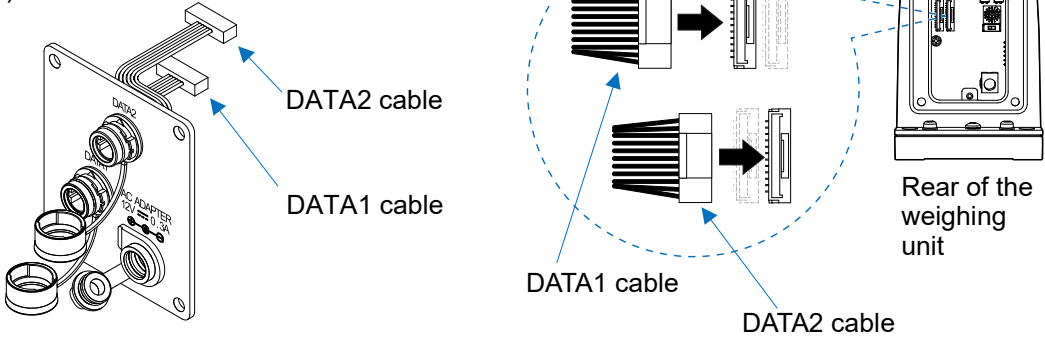
Step	Description
1	<p>Use a screwdriver to remove the screws (4 places) on the back of the weighing unit and open the panel.</p> <p style="text-align: right;">Back of the weighing unit</p> <p style="text-align: right;">Rubber packing</p> <p style="text-align: center;">Screws on the back (4 places)</p> <p>CAUTION The rubber packing has a front and back, so be careful to attach it correctly.</p> <p style="text-align: right;">Open the panel</p> 
2	<p>Disconnect the cable attached to the panel from the connector on the board. When removing the cable, pull it out while pressing the tab on the connector.</p> <p style="text-align: right;">Cable</p> <p style="text-align: right;">Connector</p> <p style="text-align: right;">Rear of the weighing unit</p> <p style="text-align: right;">Pull out while pressing the tab</p> 
3	<p>Plug the two cables attached to the RS-485 interface for daisy chain into the two connectors on the board. (The cables can be plugged into either connector.)</p> <p style="text-align: right;">2 connectors</p> <p style="text-align: right;">Rear of the weighing unit</p> <p style="text-align: right;">DATA1 cable</p> <p style="text-align: right;">DATA2 cable</p> <p>RS-485 interface for daisy chain (accessory: AD4212F-29)</p> 

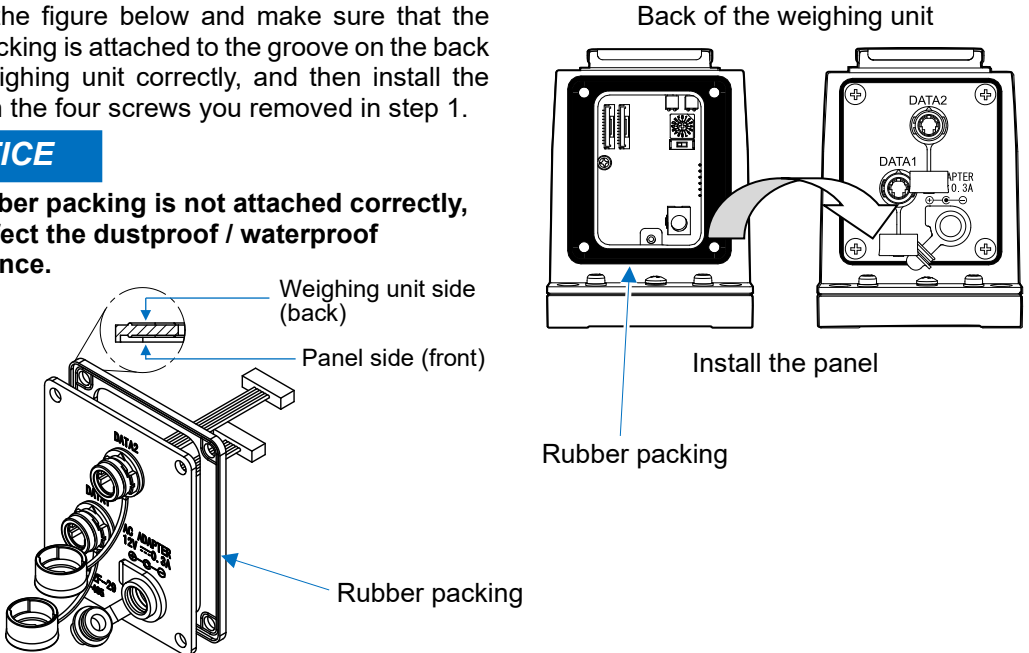
Step	Description
4	<p>Refer to the figure below and make sure that the rubber packing is attached to the groove on the back of the weighing unit correctly, and then install the panel with the four screws you removed in step 1.</p> <p>NOTICE If the rubber packing is not attached correctly, it may affect the dustproof / waterproof performance.</p> 

6-2-6. Daisy chain connection (communication cable connection)

The weighing unit with an RS-485 interface for daisy chain (accessory: AD4212F-29) has two connectors, DATA1 and DATA2. Use these two connectors to connect the weighing unit to a PC or PLC, or to connect the weighing unit to another unit.

Step 1 To connect the weighing unit to a PC or PLC, use an accessory cable AX-KO7522-500. Connect the cable to either DATA1 or DATA2. Connect the discrete wire side of the cable to a PC or PLC.

Step 2 To connect the weighing unit to another weighing unit, use an accessory cable AX-KO7622-200. Connect the cable to the connector that remains unused on the weighing unit and to either DATA1 or DATA2 on another unit.

Step 3 Connect all the weighing units to be daisy-chained by repeating step 2.

Connection example (back of the weighing unit)

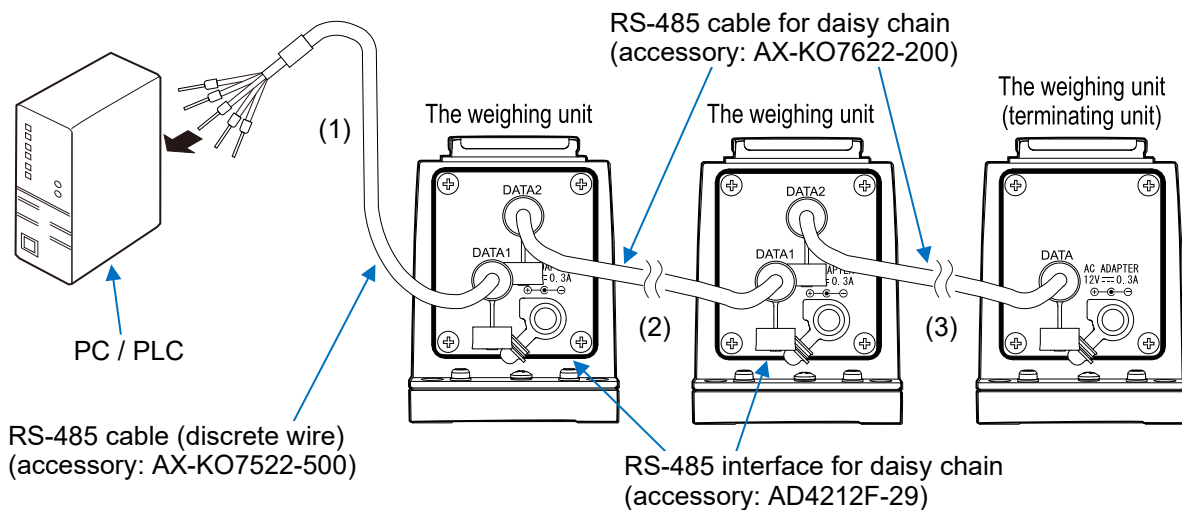

NOTICE

- ❑ If the terminating weighing unit also has an RS-485 interface for daisy chain installed, close the unused connector DATA1 or DATA 2 by attaching the rubber cap that is affixed to the packing.
- ❑ The RS-232C cable (AX-KO3590-1000) cannot be connected to the DATA1 and DATA2 connectors at the same time.

6-2-7. Daisy chain connection (AC adapter connection)

Normally, an AC adapter is connected to each weighing unit individually, but only when an accessory cable AX-KO7622-200 is used to connect one unit to another in a daisy chain, a single AC adapter is capable of supplying power for up to five units. To connect more than five units in a daisy chain, connect an AC adapter to one unit first, then connect the unit to the daisy chain. In this case, at least one AC adapter must be connected to one unit at equal intervals of no more than five units. Note that if one AC adapter is connected to supply power for more than five units in a daisy chain, the power may be insufficient for operation.

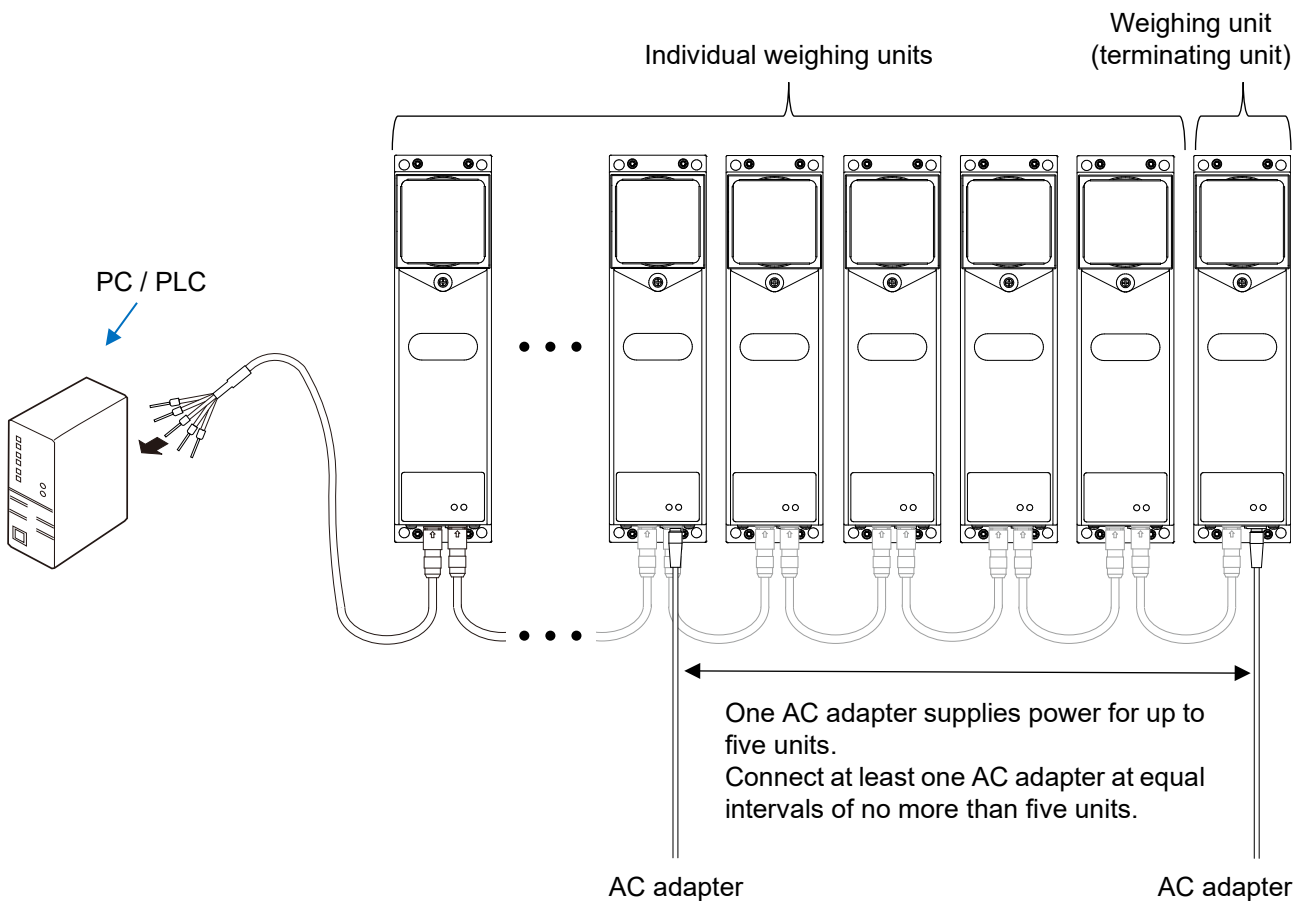

6-3. Data output format

- The output format consists of 15 characters (excluding the terminator<CR><LF>).
- The condition of the data is indicated with a 2-character header.
- The data is added with polarity.
- If the data is zero, the polarity is positive.
- For RS-485, device address information*1 is added before the header depending on the device address setting.

*1 The device address information is not added when the device address is set to "00".

Output example

1	2	3	4	5	6	7	8	9	10	11	12	13	14	15	16	17
S	T	,	+	0	0	1	2	.	3	4	5	␣	␣	g	CR	LF
Header			Data									Unit		Terminator		

When stable

S	T	,	+	0	0	1	2	.	3	4	5	␣	␣	g	CR	LF
---	---	---	---	---	---	---	---	---	---	---	---	---	---	---	----	----

When unstable

U	S	,	+	0	0	0	5	.	4	3	2	␣	␣	g	CR	LF
---	---	---	---	---	---	---	---	---	---	---	---	---	---	---	----	----

When overloaded (positive)

O	L	,	+	9	9	9	9	9	9	9	E	+	1	9	CR	LF
---	---	---	---	---	---	---	---	---	---	---	---	---	---	---	----	----

When overloaded (negative)

O	L	,	-	9	9	9	9	9	9	9	E	+	1	9	CR	LF
---	---	---	---	---	---	---	---	---	---	---	---	---	---	---	----	----

Example of RS-485 output when a device address between "01" to "99" is set

1	2	3	4	5	6	7	8	9	10	11	12	13	14	15	16	17	18	19	20
@	0	1	S	T	,	+	0	0	1	2	.	3	4	5	␣	␣	g	CR	LF

Same content as RS-232C output

Changes from 01 to 99 depending on the device address setting

Device address information

Terminator

␣	: Space,	ASCII 20h
CR	: Carriage return,	ASCII 0Dh
LF	: Line feed,	ASCII 0Ah

6-4. Command

The weighing unit can be controlled by commands.

The RS-232C output of the weighing unit continuously outputs weighing data when the power is turned on and the weighing unit is in weighing mode. When requesting weighing data with the "Q" and "S" commands, stop the continuous output of weighing data with the "C" command. Alternatively, if the command mode is set with the "PR:00" command, the settings will be saved even if the power is turned off, so continuous output will stop immediately after the power is turned on again.

Add the terminator CR LF to the following command and send it to the weighing unit.

If a device address "01" to "99" is set and a command is sent by RS-485, prefix the command with "@**". (In the place of "**", enter the device address set between "01" to "99".)

CR : Carriage return, ASCII 0Dh
LF : Line feed, ASCII 0Ah

● Commands to query weighing data

Command	Description
C	Temporarily sets to command mode. Weighing data is output according to a data request from the host. The settings will be canceled when the power supply is removed.
Q	Requests one weighing data case immediately. (The weighing data is output regardless of whether it is stable or unstable. Please use it with the continuous output stopped.)
S	Requests one weighing data case after stabilization. (The weighing data will be output after it becomes stable. Please use it with the continuous output stopped.)
SIR*1	Temporarily sets to continuous output mode. Weighing data is output continuously. The settings will be canceled when the power supply is removed. ("C" command stops continuous output.)

*1 Valid only for RS-232C output. Not valid for RS-485 output.

● Commands to control the weighing unit

Command	Description
CAL	Enters sensitivity adjustment mode.*2
OFF	Turns the display off. The weighing unit enters standby mode.
ON	Turns the display on. The weighing unit enters weighing mode.
P	Switches between weighing mode and standby mode.
PRT	Confirms the sensitivity adjustment value.
R	Sets the weighing data to zero. (re-zero)*3
SMP	Changes the readability.
U	Changes the weighing speed.*2, *4
ECL	Runs ECL.

*2 When connected via RS-232C, control characters starting with "@" are output from the weighing unit when the weighing speed (response characteristics) is switched or in the sensitivity adjustment mode.

*3 In the operation to zero the weighing data, waits for the weighing data to stabilize.

While waiting for the weighing data to stabilize, weighing data transmission from the weighing unit stops.

*4 Weighing speed (response characteristics) will not be changed when set to Customize.

● **Changing and checking the internal data of the weighing unit**

Command	Description
CW:	Weight value setting for sensitivity adjustment (including instrumental error) Example When setting to 2000.123g, CW:+2000.123_g
?CW	Weight value output for sensitivity adjustment (including instrumental error)
TM:	Time setting Example When setting to 12:34:56, TM:12:34:56
?TM	Time output
DT:	Date setting Example When setting to October 24, 2023, DT:23/10/24
?DT	Date output
?SA	Impact history output
?CD	Weighing speed (response characteristics) output Standard settings:CD,00(FAST) CD,01(MID.) CD,02(SLOW) Customize:CD,10

␣ : Space, ASCII 20h

● **Commands related to communication settings**

Port	Description		Command		
				Setting value *5	Settings
RS-232C RS-485 Common settings	Baud rate*6	Setting	BPS**	01	600 bps
				02	1200 bps
				03	2400 bps*
				04	4800 bps
				05	9600 bps
				06	19200 bps
				07	28800 bps
				08	38400 bps
				09	115200 bps
		Confirmation	?BPS Output example BP,03		
Error code output	Setting	EC:**	00	No output*	
			01	With output	
	Confirmation	?EC Output example EC,00			
Settings for RS-232C	Output mode	Setting	PR:**	00	Command mode
				03	Continuous output mode*
		Confirmation	?PRT Output example Pr,00		
Settings for RS-485	Device address*7	Setting	DAD**	00	No address*
				01~99	Set to address 00 to 99
		Confirmation	?DAD Output example DAD,00		

* Factory setting

*5 Send the command with the set value substituted for the ** part in the command field.

*6 After sending the "BPS" command, be sure to send the "P" or "ON" command or unplug and plug in the power supply.

The baud rate will be changed by resetting with the "P" or "ON" command or unplugging and plugging in the power supply.

*7 The device address set with the rotary switch has priority. (Refer to "6-2. RS-485" for details.)

6-4-1. **AK** code and error code

If you set the error code output to "with output" (send "EC:01" command to the weighing unit), it will always respond to all commands sent from the PC or PLC. Confirming the returned code improves the reliability of communication.

By setting the error code output to "with output", the weighing unit responds as follows.

- When a command requesting various data is sent to the weighing unit, if the weighing unit cannot send the requested data, it will send an error code (EC, Exx). If the weighing unit can output the requested data, it will send the requested data.
- When a command to control the weighing unit is sent to the weighing unit, if the weighing unit cannot execute the command, it will send an error code (EC, Exx). If the weighing unit can execute the command, it will send an **AK** code.
AK code is ASCII 06h code.
- The following commands are processed by the weighing unit, and it sends the **AK** code not only when the command is received, but also when processing ends. If processing does not end normally, the weighing unit will send an error code (EC, Exx).
 - "ON" command Turns on the display (puts the weighing unit in weighing mode)
 - "P" command Switches between weighing state and standby state
 - "R" command Re-zeros
 - "CAL" command Adjusts sensitivity

Error code and description

Error code	Description and possible countermeasure
EC,E01	Undefined command error An undefined command was found. Check the transmitted command.
EC,E02	Not ready The received command cannot be executed: E.g.) Q command was received when not in weighing mode. E.g.) Q command was received while re-zeroing. Adjust the delay time to transmit a command.
EC,E03	Timeout error With the command timeout setting, there was a wait time of approximately 1 second or more while receiving command characters. Check the communication.
EC,E04	Character length error The number of characters in the received command has exceeded the limit. Check the command to transmit.
EC,E06	Format error The description of the received command is incorrect: E.g.) The number of digits of numerical values is incorrect. E.g.) There are alphabet characters among the numerical values. Check the transmitted command.
EC,E07	Parameter setting error The value of the received command has exceeded the allowed value. Check the setting range of the numerical value of the command.
EC,E08	Clock battery error The clock backup battery has been depleted. Please adjust the date and time with the "DT:" or "TM:" command. Even if the clock backup battery is depleted, it works normally as long as the weighing unit is powered with the AC adapter. If the error occurs frequently, ask for repair.

Error code	Contents and countermeasures
EC,E11	<p>Stability error Weighing value is unstable and therefore the “zero display”, “sensitivity adjustment”, etc. cannot be executed. Check around the pan. Improve the environment of the installation location to prevent factors such as vibration, draft, temperature change, static electricity and magnetic field from influencing the weighing unit. Send the "CAL" command or wait 5 seconds to clear the error.</p>
EC,E20	<p>Sensitivity adjustment weight error (heavy) The weight is too heavy. Check the nominal value of the weight. Send the “CAL” command or wait for 5 seconds to clear the error.</p>
EC,E21	<p>Sensitivity adjustment weight error (light) The weight is too light. Check the nominal value of the weight. Send the “CAL” command or wait for 5 seconds to clear the error.</p>

Commands for controlling weighing data

Below is an output example when sending a command to control the weighing data.

This example is for RS-232C connection.

When connecting via RS-485, the control characters starting with "@" described in the example are not output.

Device address information is added to other data according to the device address setting value.

Also, in this example, the error code output is set to "with output" (send "EC:01" command to the weighing unit) so that the **AK** code is output.

Example of "R" command

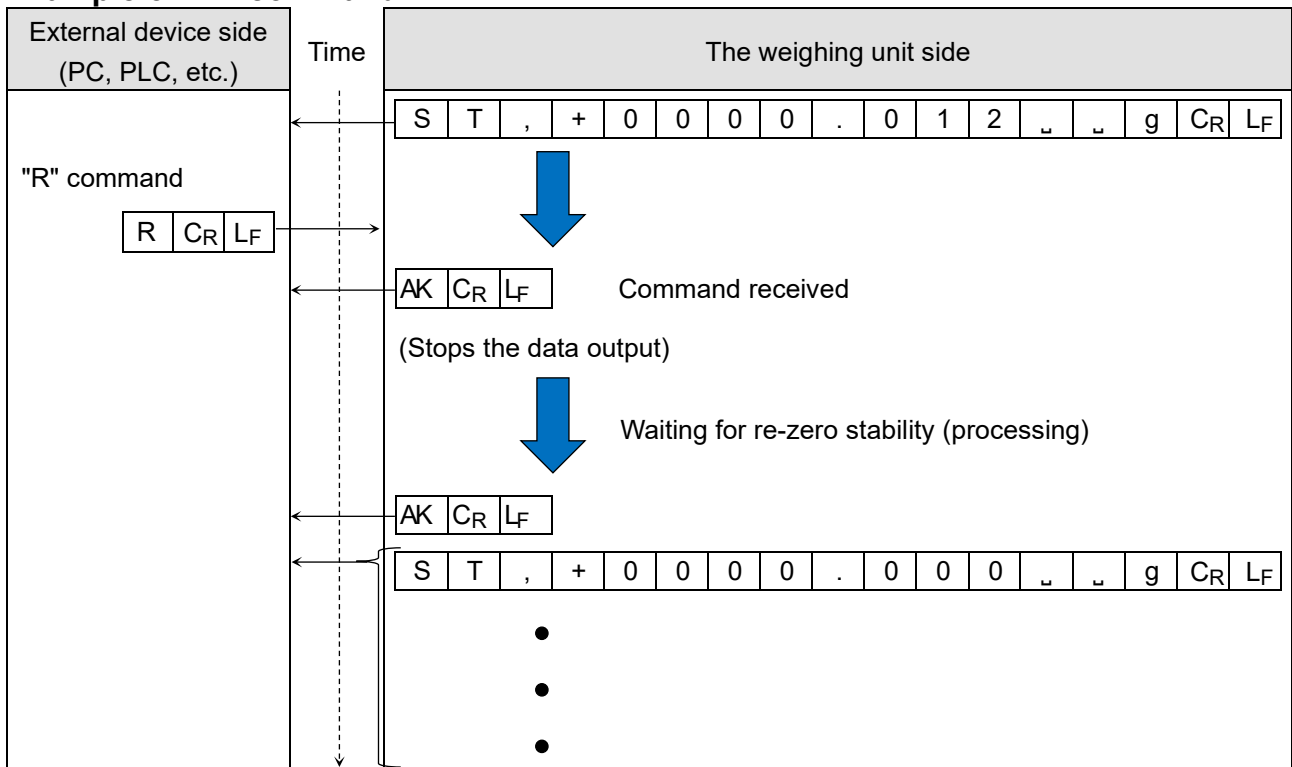

- : Space, ASCII 20h
- CR** : Carriage return, ASCII 0Dh
- LF** : Line feed, ASCII 0Ah
- AK** : Acknowledge, ASCII 06h

Example of "CAL" command

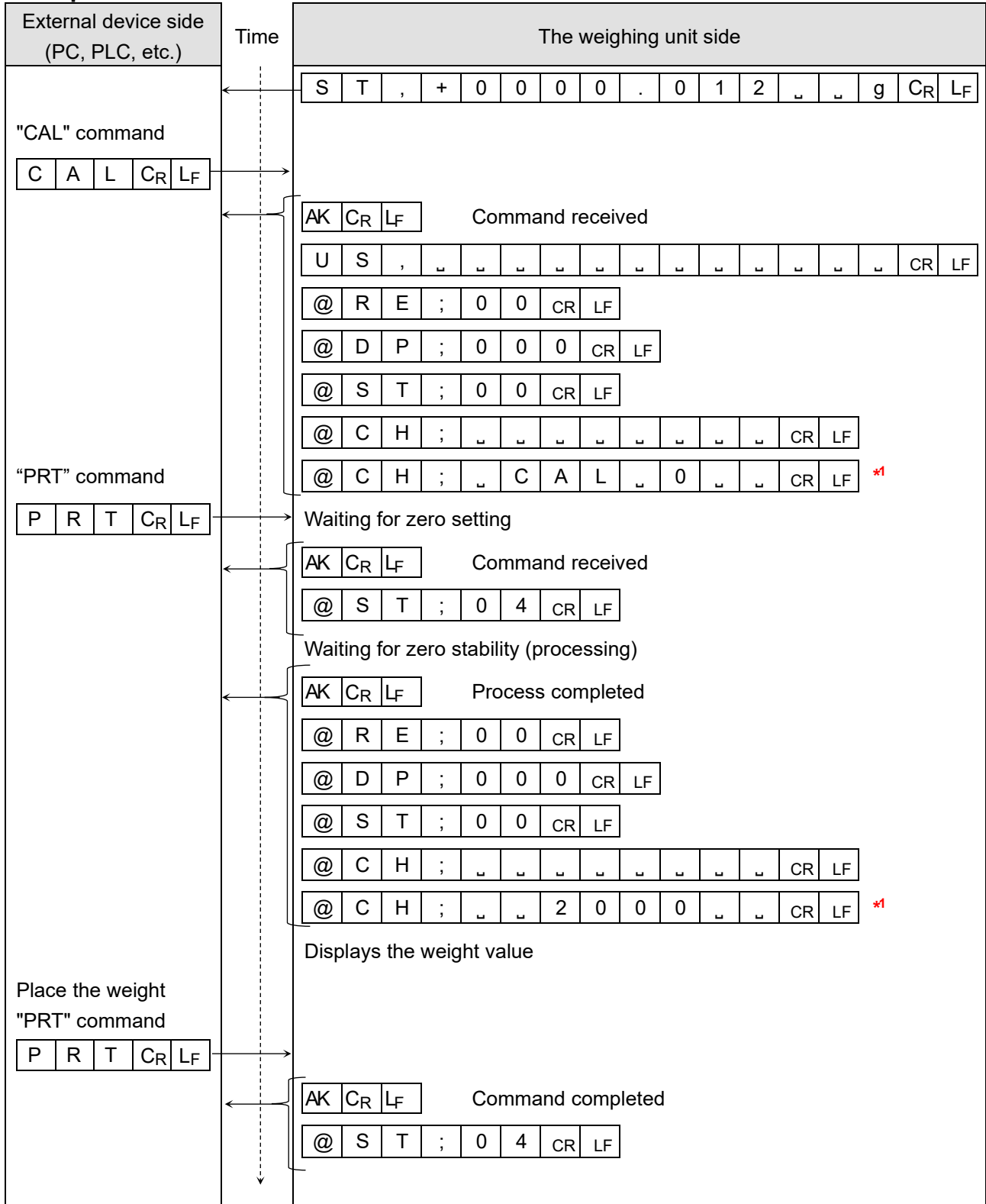

Continued on next page

*1 For RS-485, the data is output without "@CH;".

␣	: Space,	ASCII 20h
CR	: Carriage return,	ASCII 0Dh
LF	: Line feed,	ASCII 0Ah
AK	: Acknowledge,	ASCII 06h

Continued from previous page

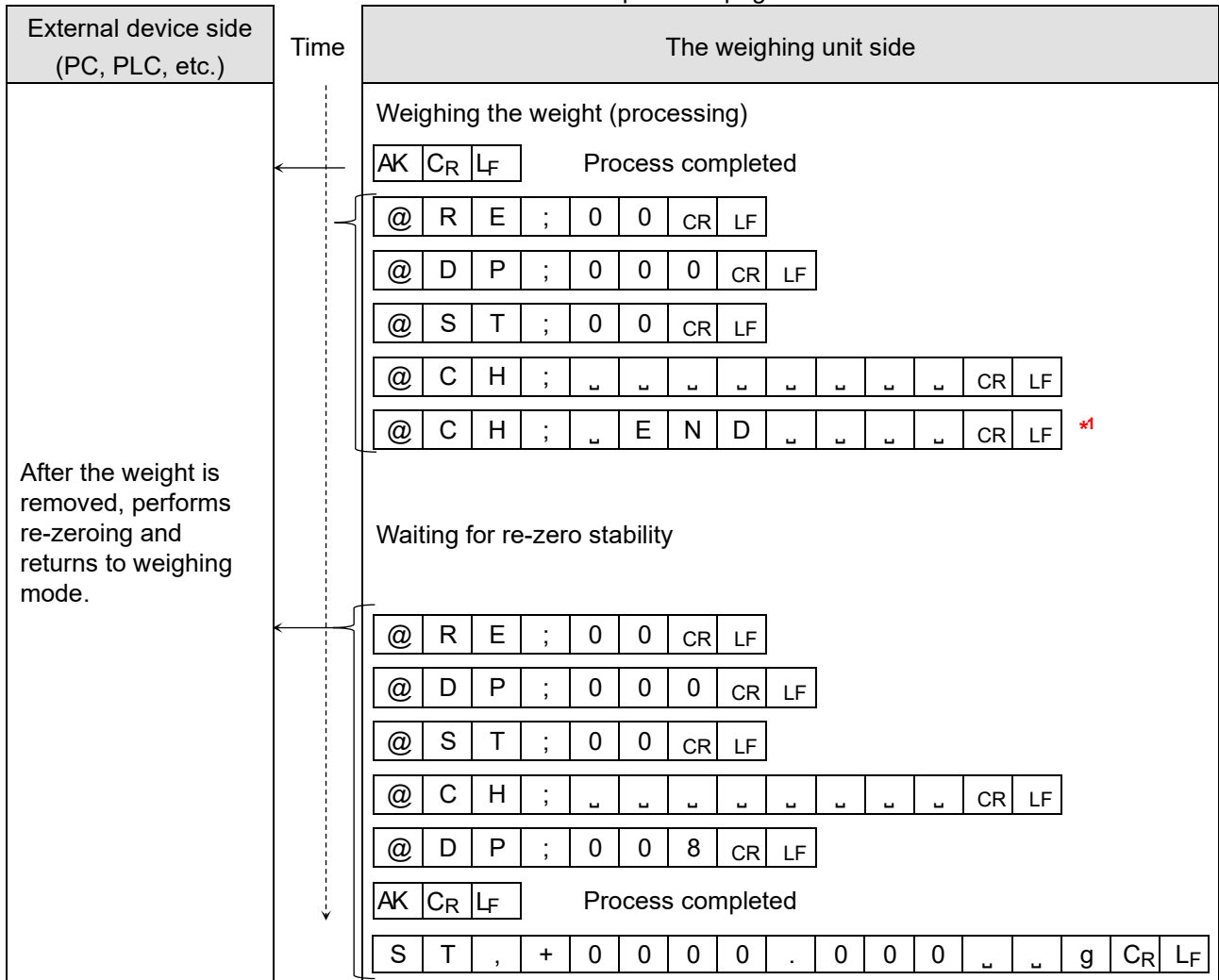

*1 For RS-485, the data is output without "@CH;".

- _ : Space, ASCII 20h
- CR : Carriage return, ASCII 0Dh
- LF : Line feed, ASCII 0Ah
- AK : Acknowledge, ASCII 06h

Example of "SMP" command

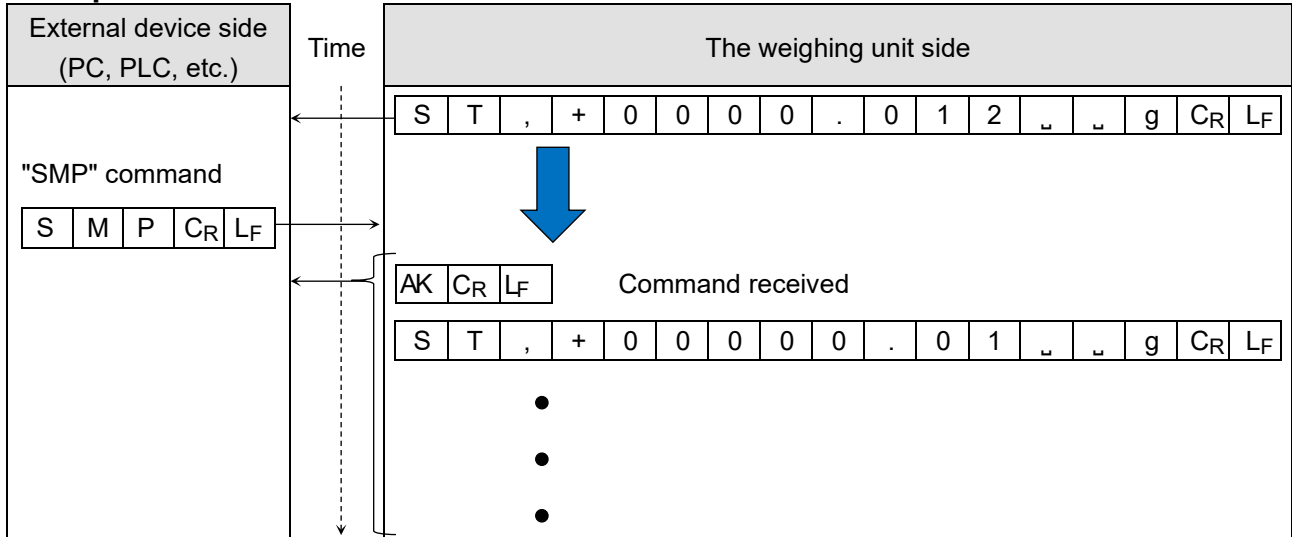

Example of the "R" command when the precision range is used

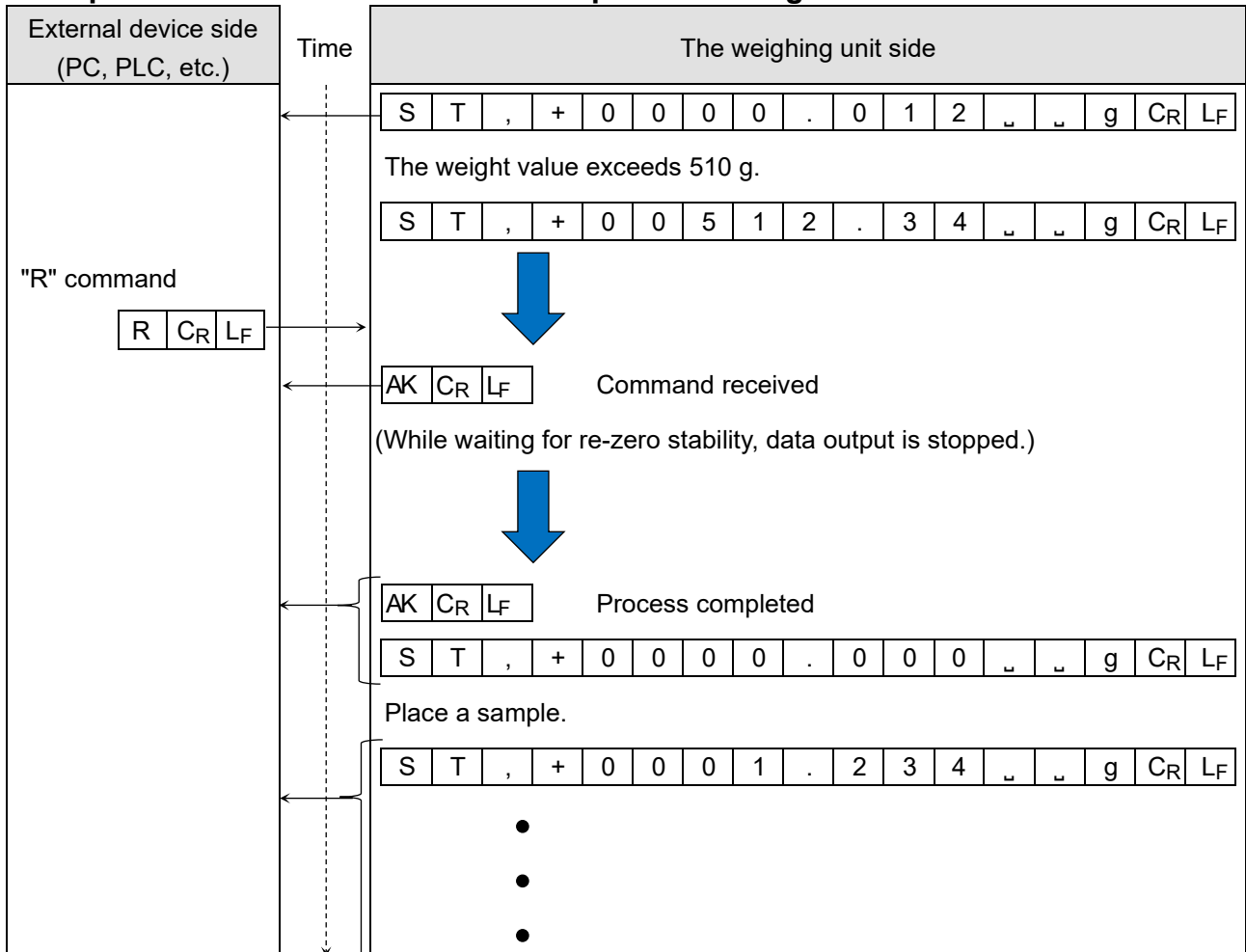

- _ : Space, ASCII 20h
- CR : Carriage return, ASCII 0Dh
- LF : Line feed, ASCII 0Ah
- AK : Acknowledge, ASCII 06h

7. Maintenance

7-1. Care

- ❑ When cleaning the weighing unit, wipe it with a lint free cloth that is moistened with warm water and a mild detergent.
- ❑ Do not use organic solvents or chemical wipes.
- ❑ Do not disassemble the weighing unit.
- ❑ Use the original packing material for transport.
- ❑ The dustproof and waterproof performance of the weighing unit means waterproof for daily use, so the weighing pan can be washed with water while installed. Note that if the weighing unit is submerged in water or used in such a way that water pressure is applied to the bottom of the weighing unit body, water may enter the interior of the weighing unit.
- ❑ When using the weighing unit in a dustproof / waterproof environment, make sure that the AC adapter plug is fully inserted into the AC adapter input jack and that the RS-232C cable is attached.
- ❑ When not using the AC adapter or RS-232C cable, the rubber cap of each packing ring must be closed.
- ❑ When cleaning with hot water, condensation may occur inside the weighing unit and the weighing unit parts may deteriorate. Also, be careful not to let water vapor get inside the weighing unit.

Rear of the weighing unit

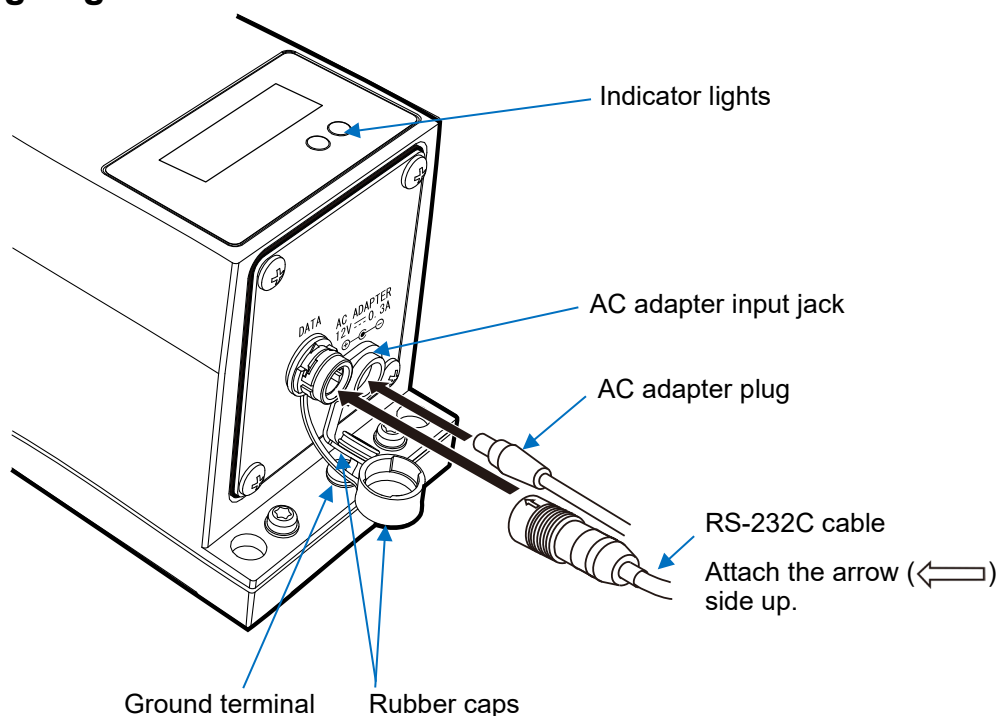

Weighing unit bottom

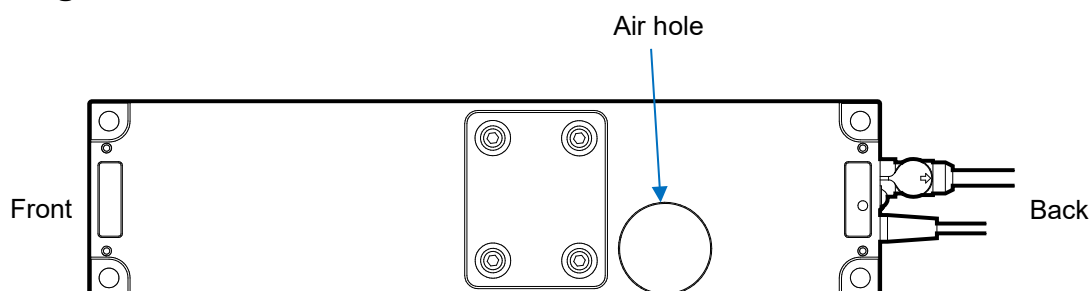

8. Troubleshooting

8-1. Checking the weighing unit performance and environment

Since the weighing unit is a precision instrument, in some cases it may not be able to measure correct values due to adverse effects of the measurement environment or measurement method.

If repeatability is poor when the sample is loaded and unloaded several times, or if the weighing unit seems to be operating abnormally, check the following items.

"[Frequently Asked Questions](#)" and answers to them are also posted on our website (<https://www.aandd.jp/>).

If the problem persists after checking each item, contact your local A&D dealer for repair.

1. Checking that the weighing unit performs properly

- As a simpler test, check the repeatability with an external weight. Be sure to place the weight in the center of the weighing pan. Pay attention to the airflow and be sure to cover the weighing unit if necessary.
- As a precise test, check the repeatability, linearity, weighing value, etc. with a weight of a known weight.
- When the weighing unit is incorporated into a system, remove the weighing unit from the system. Place it on a solid table and perform checking.

When proper performance of the weighing unit is confirmed, refer to "[2-3.Precautions when incorporating into a system](#)" to set up the installation site.

2. Checking that the measurement environment and method are appropriate

Check the following check items. Also, refer to "[2-3.Precautions when incorporating into a system](#)".

Operating environment

- Is the weighing table solid enough?
- Is the operating environment free from vibration and drafts? Note that covering the weighing unit can reduce the effects of draft.
- Is there a strong electrical or magnetic noise source such as a motor near the weighing unit?
- Is there a heat source near the weighing unit?

Weighing method

- Is the exclusive weighing pan or jig set so that it does not touch other parts of the weighing unit main body? (Is the weighing pan installed correctly?)
- Do you always set the weight value to zero by sending the "R" command before placing your sample on the weighing pan?
- Do you place your sample in the center of the weighing pan?
- Did you connect the weighing unit to the power supply for at least 30 minutes to warm up before weighing?
- If the weighing unit wobbles on the installation surface, the weighing data may become unstable or the repeatability may become poor. Improve such installation conditions by securing the weighing unit or reducing the vibration to the weighing unit.

Sample and container

- Is the sample free from moisture absorption or evaporation?
- Are the temperatures of the sample and the container acclimatized to the ambient temperature? Refer to "[2-3.Precautions when incorporating into a system](#)".
- Is the sample free of static electricity? Refer to "[2-3.Precautions when incorporating into a system](#)".
- Is the sample a magnetic material (iron, etc.)? Care must be taken when weighing magnetic materials. Refer to "[2-3.Precautions when incorporating into a system](#)".

8-2. Asking for repair

If the weighing unit needs service or repair, please contact your local A&D dealer.

The weighing unit is a precision instrument. Use much care when handling the weighing unit and observe the following when transporting the weighing unit.

- Use the original packing material.
- Remove the weighing pan from the weighing unit.

9. Specifications

		AD-4212F-6203D	AD-4212F-10202		AD-4212F-22001	
Weighing capacity		6200 g / 510 g ^{*1}	10200 g		22000 g	
Maximum display		6200.08 g / 510.009 g	10200.84 g		22008.4 g	
Readability		0.01 g / 0.001 g	0.01 g		0.1 g	
Repeatability (Standard deviation)		0.01 g / 0.002 g	0.01 g		0.1 g	
Linearity		±0.02 g		±0.03 g		±0.2 g
Stabilization time in seconds ^{*2}		When 0.001 g readability is selected	1.3 seconds ^{*3}	0 to 300 g	0.5 seconds	0 to 300 g
		When 0.01 g readability is selected	1.0 seconds	300 to 10200 g	1.0 seconds	300 to 22000 g
Data refresh rate		Approx. 3 times/second to 100 times/second (about 13 times/second [*])				
I/O section	RS-232C RS-485	Bidirectional, 600 to 115200 bps (2400 [*] bps)				
Sensitivity drift		±2 ppm/°C (10 °C to 30 °C / 50°F to 86°F)			±3 ppm/°C (10 °C to 30 °C / 50°F to 86°F)	
Operating temperature / humidity range		5 °C to 40 °C (41°F to 104°F), 85 %RH or less (no condensation)				
Allowable eccentric load		1 Nm or less (based on the plate center)				
Usable weight value		50 g, 100g, 200 g, 300 g, 500 g, 1000 g, 2000 g [*] , 3000 g, 4000 g, 5000 g, 6000 g	500 g, 1000 g, 2000 g, 3000 g, 4000 g, 5000 g [*] , 6000 g, 7000 g, 8000 g, 9000 g, 10000 g	1000 g, 2000 g, 5000 g, 10000 g [*] , 20000 g		
The weighing unit	External dimensions	80 (W) × 320 (D) × 128 (H) mm				
	Weighing pan dimensions	70 × 70 mm				
	mass	Approx. 3.2 kg				
Unit display mode		g				
Power (AC adapter)		AC adapter Confirm that the adapter type is correct for the local voltage and power receptacle type. Power consumption: Approx. 30 VA (supplied to the AC adapter)				
Dustproof and waterproof		IP65 compliant				

* Factory setting

^{*1} Smart range (Refer to "4. Smart Range Function".)

^{*2} When the stability band width is set to ±3 digits and **FAST** is selected for the weighing speed (response characteristics) in a good environment.

^{*3} Specifications when using the precision range

9-1. External dimensions

AD-4212F-6203D / AD-4212F-10202 / AD-4212F-22001

Pan support dimensions

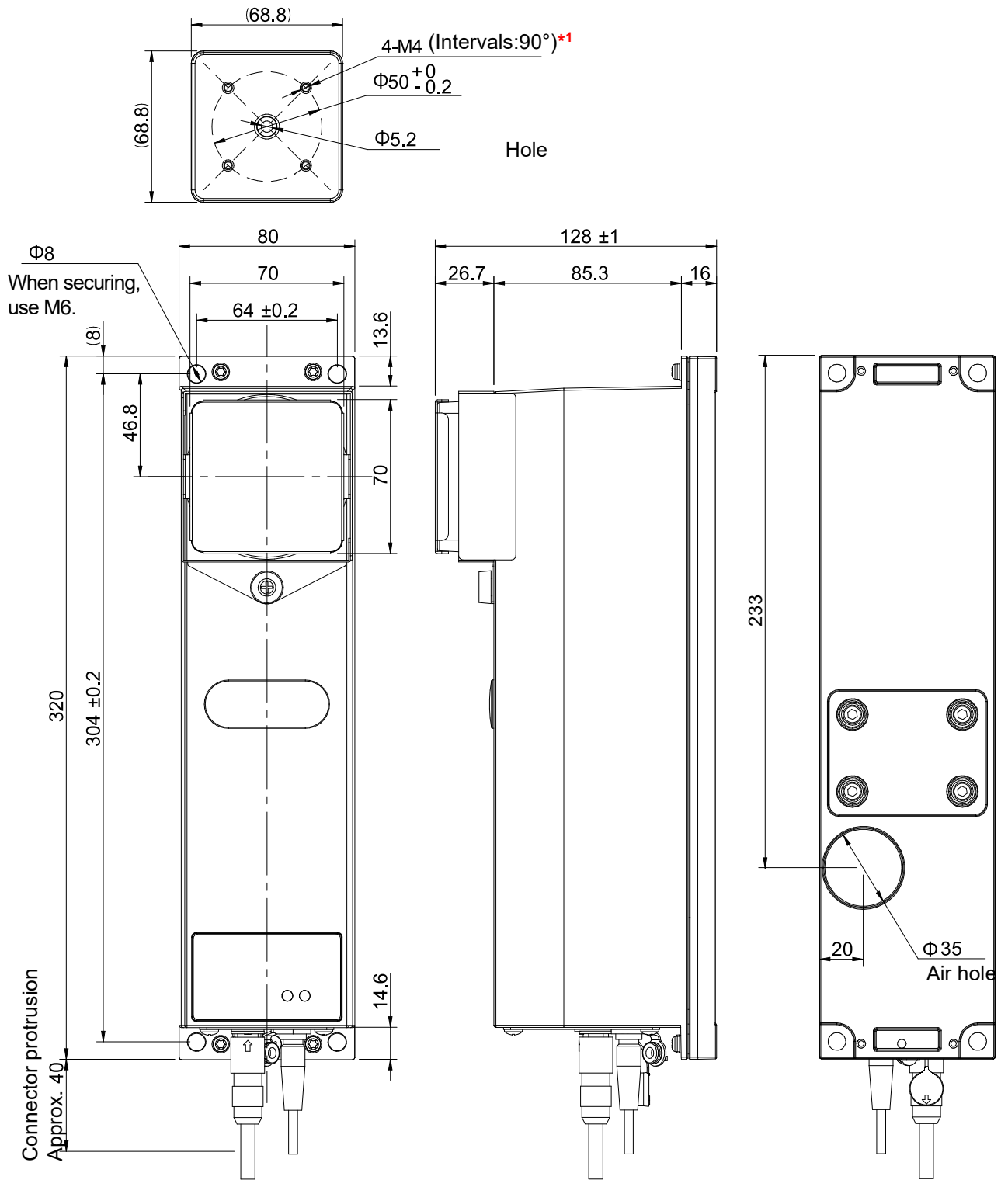

Unit: mm

*1 The screw holes to secure the exclusive weighing pan created by customers.

10. Peripherals (sold separately)

10-1. Accessories

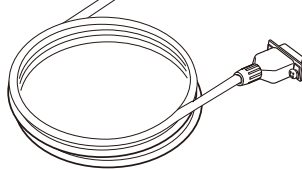
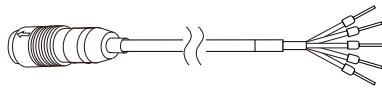
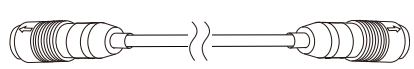
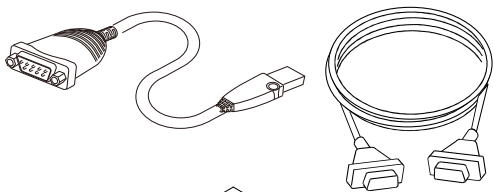
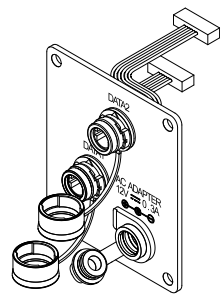
AX-KO3590-200	RS-232C cable	2 m	
AX-KO3590-500	RS-232C cable	5 m	
AX-KO3590-1000	RS-232C cable	10 m	
AX-KO7522-500	RS-485 cable (discrete wire)	5 m	
AX-KO7622-200	RS-485 cable (for daisy chain)	2 m	
AX-USB-9P-EX	USB converter cable set		
<input type="checkbox"/> USB converter (D-Sub9 pin - USB) <input type="checkbox"/> RS-232C cable (D-Sub9 pin - D-Sub9 pin)*1			
	*1 The AD-4212F series does not use this cable.		
AD4212F-29	RS-485 interface (for daisy chain)		

10-2. Options

AD-8922A remote controller

- Displays the weighing data of the weighing unit and remotely operates re-zero and sensitivity adjustment.
- Options for BCD output (AD-8922A-01), comparator output (AD-8922A-04), and analog output (AD-8922A-06) are available for AD-8922.

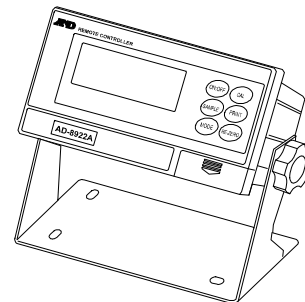

AD-8923-BCD/CC remote controller

- ❑ Displays the weighing data of the weighing unit and remotely performs re-zero and sensitivity adjustment.
- ❑ The AD-8923-BCD can output data using BCD.
The AD-8923-CC can output data using CC-Link.

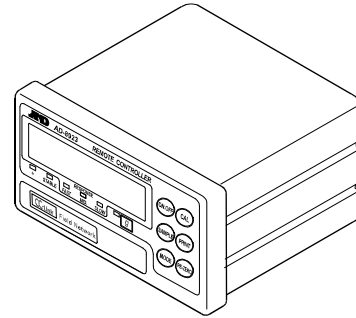

AD-8551R Modbus RTU converter

- ❑ RS-232C output from the weighing unit can be converted to Modbus RTU.

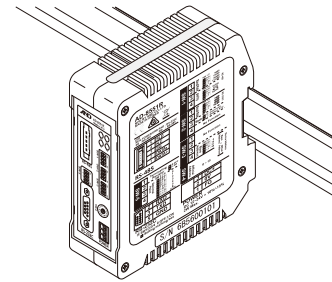

AD-8552 EtherNet/IP converter

- ❑ RS-232C output from the weighing unit can be converted to EtherNet/IP.

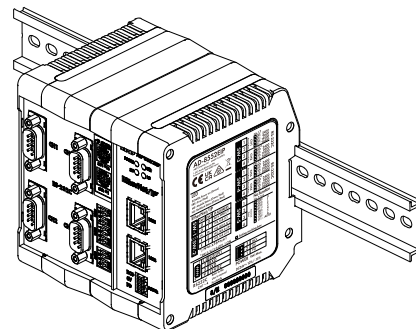

AD-1683 DC static eliminator

Main features

- ❑ Static eliminator that prevents error which can be caused when weighing samples are electrically charged.
- ❑ Its direct-current system and plentiful ion content enable weighing without breeze, which is ideally suited for precisely measuring powder and such.

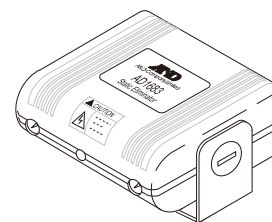

AD-1684A electrostatic field meter

- ❑ An indicator that measures how much the weighing sample and tare, or the weighing unit's peripheral devices (e.g. automatic weighing line) are electrically charged and shows the result.

When electric charge is observed, it can be eliminated with AD-1683 (Ionizer).

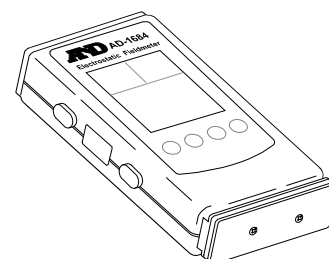

11. Terms

Terms	Description
Stable display	The weighing value when the stabilization indicator is displayed.
Environment	Ambient conditions such as vibration, drafts, temperature, static electricity, magnetic fields, and the like that affect the weighing operation.
Sensitivity adjustment	Adjustment of the weighing unit so that it can weigh accurately.
Output	To output the weighing data using the RS-232C or RS-485 interface.
Zero point	A weighing reference point or the zero display. Usually refers to the value displayed when nothing is on the weighing pan.
Digit	(Readability) digit is the unit of digital resolution. 1 digit is the smallest display value weighed by the weighing unit.
Tare	To cancel the weight of a container, paper, etc. not to be weighed that is placed on the weighing pan.
Re-zero	To set the display to zero.
Repeatability (Standard deviation)	Variation in measured values obtained when the same weight is placed and removed repeatedly. Usually expressed as a standard deviation. E.g.) Standard deviation = 1 digit: This means that the measured values fall within ± 1 digit at a probability of about 68%.
Stabilization time	The time until the weighing value is displayed with the stabilization indicator shown after a sample is placed on the weighing pan.
Sensitivity drift	An affect that a change in temperature causes to the weighing data. Expressed as temperature coefficient. E.g.) Temperature coefficient = 2 ppm/°C: If a load is 300 g and the temperature changes by 10 °C, the value displayed changes by the following value. $0.0002 \text{ } \%/^{\circ}\text{C} \times 10 \text{ } ^{\circ}\text{C} \times 300 \text{ g} = 6 \text{ mg}$
IP65 dustproof and waterproof rating	IP65 is a rating that indicates no ingress of dust and no harmful influence by receiving direct jets of water from any direction. Note that the weighing unit will not withstand strong direct water jets or being completely immersed in water.

THIS PAGE INTENTIONALLY LEFT BLANK.



A&D Company, Limited

3-23-14 Higashi-Ikebukuro, Toshima-ku, Tokyo 170-0013, JAPAN
Telephone: [81] (3) 5391-6132 Fax: [81] (3) 5391-1566

A&D ENGINEERING, INC.

47747 Warm Springs Blvd, Fremont, California 94539, U.S.A.
Tel: [1] (800) 726-3364 Weighing Support:[1] (888) 726-5931 Inspection Support:[1] (855) 332-8815

A&D INSTRUMENTS LIMITED

Unit 24/26 Blacklands Way, Abingdon Business Park, Abingdon, Oxfordshire OX14 1DY United Kingdom
Telephone: [44] (1235) 550420 Fax: [44] (1235) 550485

A&D AUSTRALASIA PTY LTD

32 Dew Street, Thebarton, South Australia 5031, AUSTRALIA
Telephone: [61] (8) 8301-8100 Fax: [61] (8) 8352-7409

A&D KOREA Limited

한국에이.엔.디(주)
서울특별시 영등포구 국제금융로6길33 (여의도동) 맨하탄빌딩 817 우편 번호 07331
(817, Manhattan Bldg., 33. Gukjegeumyung-ro 6-gil, Yeongdeungpo-gu, Seoul, 07331 Korea)
전화: [82] (2) 780-4101 팩스: [82] (2) 782-4264

OOO A&D RUS

ООО "ЭЙ энд ДИ РУС"

Почтовый адрес: 121357, Российская Федерация, г.Москва, ул. Верейская, дом 17
Юридический адрес: 117545, Российская Федерация, г. Москва, ул. Дорожная, д.3, корп.6, комн. 86
(121357, Russian Federation, Moscow, Vereyskaya Street 17)
тел.: [7] (495) 937-33-44 факс: [7] (495) 937-55-66

A&D Instruments India Private Limited

ऐ&डी इन्स्ट्रुमेन्ट्स इण्डिया प्रा० लिमिटेड

D-48, उद्योग विहार , फेस -5, गुडगांव - 122016, हरियाणा , भारत
(D-48, Udyog Vihar, Phase-V, Gurgaon - 122016, Haryana, India)
फोन : [91] (124) 4715555 फैक्स : [91] (124) 4715599

A&D SCIENTECH TAIWAN LIMITED.

A&D台灣分公司 艾安得股份有限公司

台湾台北市中正區青島東路5號4樓
(4F No.5 Ching Tao East Road, Taipei Taiwan R.O.C.)
Tel : [886](02) 2322-4722 Fax : [886](02) 2392-1794

A&D INSTRUMENTS (THAILAND) LIMITED

บริษัท เอ แอนด์ ดี อินสตรูमेंท์ (ไทยแลนด์) จำกัด

168/16 หมู่ที่ 1 ตำบลรังสิต อำเภอธัญบุรี จังหวัดปทุมธานี 12110 ประเทศไทย
(168/16 Moo 1, Rangsit, Thanyaburi, Pathumthani 12110 Thailand)
Tel : [66] 20038911