

GX-A/GF-A Series Options

INSTRUCTION MANUAL

GXA-03	RS-232C Isolated Interface
GXA-04	Comparator output
GXA-06	Analog voltage output

The logo for A&D Company, Ltd. consists of the letters 'A' and 'D' in a bold, stylized, sans-serif font. The 'A' and 'D' are connected at the top, and the 'D' has a thick, blocky appearance.

A&D Company, Ltd.

© 2017 A&D Company, Limited. All rights reserved.

No part of this publication may be reproduced, transmitted, transcribed, or translated into any language in any form by any means without the written permission of A&D Company, Limited.

The contents of this manual and the specifications of the instrument covered by this manual are subject to change for improvement without any notice and obligation on the part of the manufacturer.

Contents

1.	Introduction.....	4
2.	Features	4
3.	Packing List.....	5
4.	Installing the Option	5
5.	Function Table of Balance.....	6
5.1.	Operation Keys and Display of Function Table.....	6
5.2.	Items List of the Function Table	7
6.	GXA-03 Isolated RS-232C interface	10
6.1.	Specifications of Serial Interface.....	10
7.	GXA-04 Comparator Output.....	11
7.1.	Specifications of Comparator Output	11
7.2.	Using the Comparator Output.....	12
7.3.	Comparison Method Selection (Tolerance Range and Center Value or Threshold Values)	13
7.4.	Setting Threshold Values	14
7.5.	Setting Center Value and Tolerance Range.....	15
8.	GXA-06 Analog Voltage Output.....	17
8.1.	Specifications of Analog Voltage Output	17
8.2.	Function Table of Analog Voltage Output.....	18
8.3.	Voltage Output Selection.....	20
8.4.	Voltage Output Fine Adjustment.....	20
8.5.	Fixed Voltage Output	21

1. Introduction

This manual describes options for the GX-A series and GF-A series and how to get the most out of them in terms of performance. Read this manual thoroughly before using the options and keep it at hand for future reference.

2. Features

The following options can be used for the GX-A series and GF-A series.

- GXA-03 Isolated RS-232C interface
- GXA-04 Comparator output (with buzzer) / External contact input x 2
- GXA-06 Analog voltage output

GXA-03: Isolated RS-232C interface

- Commands from the PLC or other devices installed in the factory environment can be used to make the following operations : output measurement data from the balance, input parameters into the balance, control the balance, reference parameters of the balance, etc.
- The RS-232C is equipped with a data format to manage the balance in accordance with GLP. (Refer to the instruction manual of the balance.)



GXA-04: Comparator output / External contact input

- The GXA-04 can compare the weighing value and preset threshold values and can output the result to the contact output.
- The GXA-04 is equipped with six contact outputs: "HH", "HI", "OK", "LO", "LL" of the comparison output and "READY" output to indicate the status of the balance.
3-stage comparison or 5-stage comparison can be selected.
- The GXA-04 can sound a buzzer according to the comparison result.
- The GXA-04 is equipped with external control input terminals that can make the RE-ZERO and PRINT key operations. An optional foot switch (AX-SW137-PRINT, AX-SW137-RE-ZERO) can be used.

GXA-06: Analog voltage output

- The GXA-06 can output analog voltage in the following modes :
"mode where the specified digits of the weighing value are converted to voltage" and
"mode where weighing value is converted to voltage in range between gross zero or net zero and full scale".
- The voltage output range can be selected using the "0V~/0.2V~" switch on the panel.
It can be selected "0 to 1V" range and "0.2V to 1V" range. The factory setting is "0 to 1V" range.

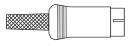
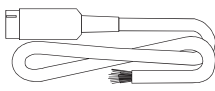
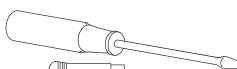
3. Packing List

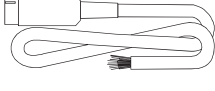
GXA-03This manual	1	
GXA-04Mini DIN connector (8 pin, plug)	1	
Cable with connector (AX-KO5692)	1	
This manual	1	
GXA-06Screwdriver for adjustment	1	
Mini DIN connector (4 pin, plug)	1	
Cable with connector (AX-KO5692)	1	
This manual	1	

4. Installing the Option

Caution Disconnect the AC adaptor before installing the option to the balance.

Installing the option board to the balance

Step1 Remove the two screws from the panel.
Pull gently the cable and option board from the balance.

Step2 Peel off the connector that is affixed to the panel with double-sided tape and insert it into the socket of the option board.

Step3 Attach the option board to the balance.
Secure with the two screws removed in step 1.

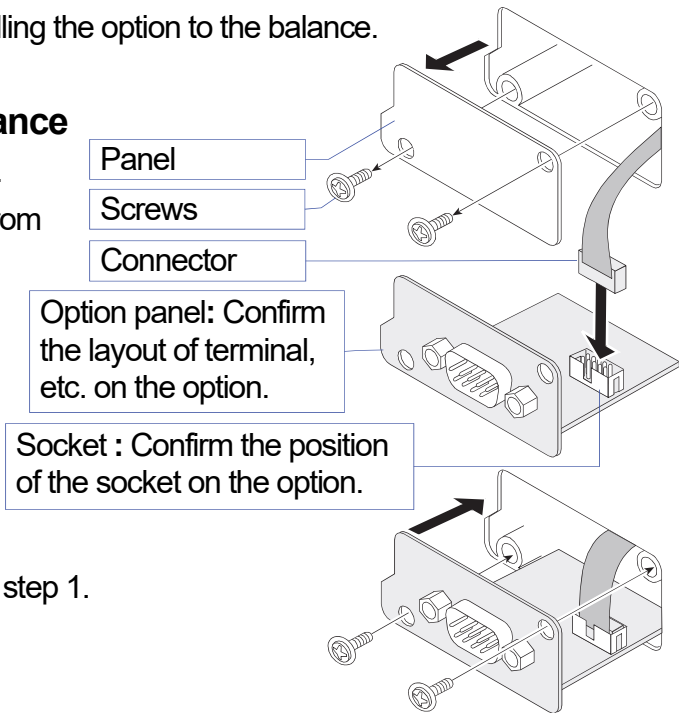

Assembling the mini-DIN connector

You can use the GXA-04 (AX-K0592) and GXA-06 (AX-K0593) of the option cable assembled with the mini-DIN connector.

- Step 1 Pass the cable through the rubber sleeve.
- Step 2 Solder wires and terminal.
- Step 3 Cover the terminal with the top metal case and bottom metal case.
- Step 4 Fasten wires with the top metal case.
- Step 5 Insert the assembled parts into the rubber sleeve.

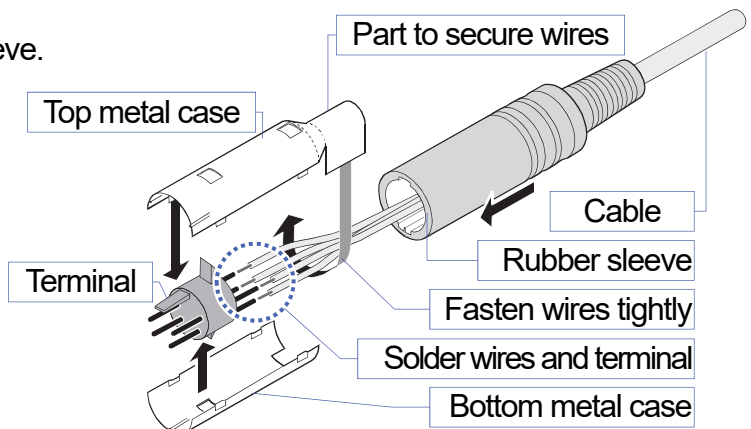

5. Function Table of Balance

The function table stores parameters that specify how to operate the balance, and it is used to monitor or update those parameters. These parameters are stored in memory even if the AC adaptor is removed and are retained until overwritten. Balance operations are specified by this table when using the GXA-03, GXA-04 and GXA-06. The table menu consists of two layers as shown in the diagram below. The first layer is the "Class" and the second layer is the "Item". Each item stores a "parameter". The last displayed parameter is in effect. After the **PRINT** key is pressed, these updated parameters are applied to operations of the balance.

Example of settings and menu structure

Example : Set to "Center value using sample weight input" of "Input method" in "Comparator".

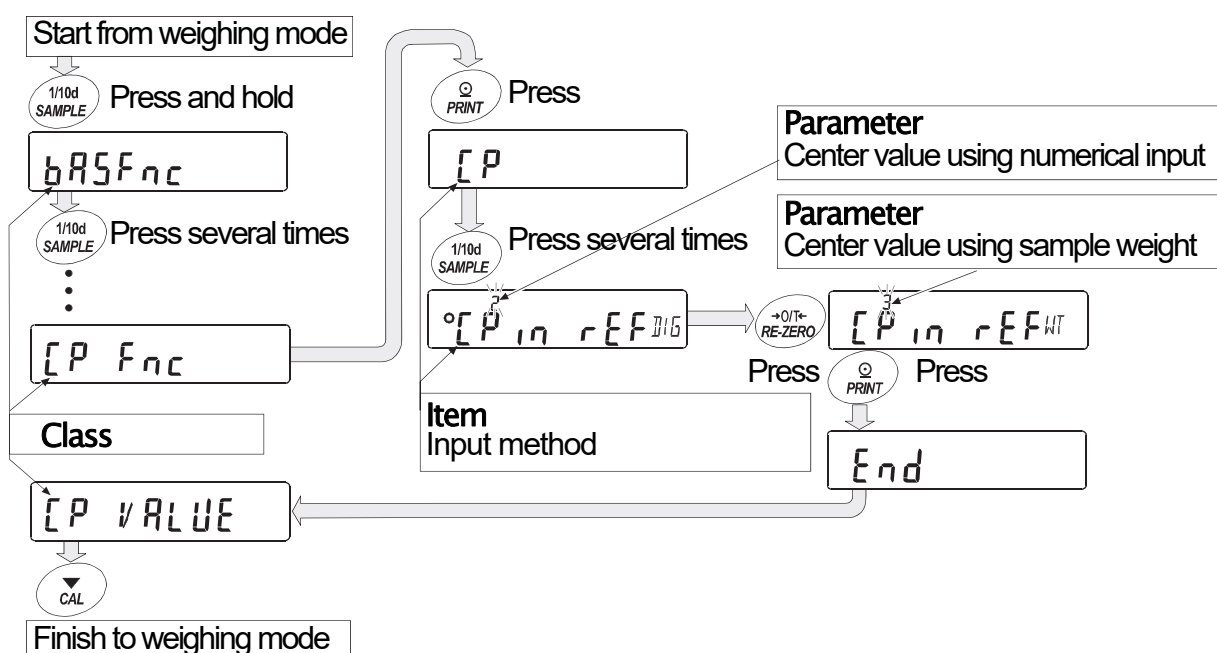

Caution

The balance may not function properly, depending on the settings and the operating environment. Be sure to set parameters correctly.

5.1. Operation Keys and Display of Function Table

○	The ○ indicates that the parameter displayed is in effect.
1/10d SAMPLE	Enters the function table when pressed and held in the weighing mode. Selects the class or item in the function table.
+0/⇄ RE-ZERO	Changes the parameter.
PRINT	Moves to an item in the class when a class is displayed. Stores the new parameter and displays the next class when an item is displayed.
▼ CAL	Cancels new parameter and displays the next class when an item is displayed. Exits the function table and returns to the weighing mode when a class is displayed.

5.2. Items List of the Function Table

Note Functions available differ by model of the balance.

Class	Item	Parameter	Description	
<i>bASFnC</i> Environment, display			(Refer to the instruction manual of main unit)	
<i>[L Adj</i> Clock adjustment				
<i>[P Fnc</i> Comparator	<i>[P</i> Comparator mode	■ 0	No comparison (Comparator is not used)	
		1	Comparison when stable value or overloaded	
		2	Comparison always	
	<i>[P-t</i> Comparison method	■ 0	3-stage comparison	HI, OK, LO
		1	5-stage comparison	HH, HI, OK, LO, LL
	<i>[P-z</i> Near zero	0	Comparison including near zero	
		1	Comparison excluding ±5 digits (counts) from zero	
		■ 2	Comparison excluding ±10 digits (counts) from zero	
		3	Comparison excluding ±20 digits (counts) from zero	
		4	Comparison excluding ±50 digits (counts) from zero	
	<i>[P-P</i> Polarity	0	Comparison of positive values only	
		1	Comparison of negative values only	
		■ 2	Comparison of both polarities	
	<i>[P in</i> Input method	■ 0	Threshold value using numerical input	<i>[P HH]</i> , <i>[P HI]</i> , <i>[P LO]</i>
		1	Threshold value using sample weight	and <i>[P LL]</i> are used
		2	Center value using numerical input	<i>[P rEF]</i> , <i>[P LMt]</i> and
	<i>[P-Frd</i> Flow measurement	■ 0	Comparison by flow rate value	
		1	Comparison by weighing value (g)	
<i>[P VALUE</i> Comparator threshold value	<i>[P HH]</i> Second upper limit	Refer to explanation of "7. GXA-04 Comparator output". Upper / lower limits when using the data input method (<i>[P in</i> 0 or <i>[P in</i> 1) is selected.		
	<i>[P HI]</i> Upper limit			
	<i>[P LO]</i> Lower limit			
	<i>[P LL]</i> Second lower limit	<i>[P HH]</i> , <i>[P LL]</i> are displayed when 5-stage comparison (<i>[P-t</i> 1) is selected.		
	<i>[P rEF]</i> Center value	Refer to explanation of "7. GXA-04 Comparator output". Reference value when using the data input method (<i>[P in</i> 2 or <i>[P in</i> 3) is selected.		
	<i>[P LMt]</i> Tolerance range from center value			
	<i>[P LMt2]</i> Second tolerance range from center value			

■ indicates factory settings. Digit is the unit of minimum division (minimum weighing value).

Class	Item	Parameter	Description	
[P] bEEP Comparator buzzer	bEP HH HH buzzer	■ 0	Off	Displayed only when 5-stage comparison ([P-4] [1]) is selected.
		1	On	
	bEP Hi Hi buzzer	■ 0	Off	
		1	On	
	bEP OK OK buzzer	■ 0	Off	
		1	On	
bEP Lo Lo buzzer	■ 0	Off		
	1	On		
bEP LL LL buzzer	■ 0	Off	Displayed only when 5-stage comparison ([P-4] [1]) is selected.	
	1	On		
dout Data output	(Refer to instruction manual of main unit)			
S,F Serial interface				
USB USB interface				
oP-5,F Option serial interface	Mode Connection	■ 0	Computer	
		1	Printer	
		2	External display	
	bPS Baud rate	0	600 bps	
		1	1200 bps	
		■ 2	2400 bps	
		3	4800 bps	
		4	9600 bps	
		5	19200 bps	
		6	38400 bps	
	bEP _r Data bit, parity bit	■ 0	7 bits, Even	
		1	7 bits, Odd	
		2	8 bits, None	
	[r]LF Terminator	■ 0	CR LF	CR: ASCII code 0Dh
		1	Do not use	LF: ASCII code 0Ah
	tYPE Data format	■ 0	A&D standard format	
		1	DP format	
		2	KF format	
		3	MT format	
		4	NU format	
		5	CSV format	
	t-UP Timeout	■ 0	No limit	Select wait time to receive a command
		1	1 second	
	ErCd AK, Error code	■ 0	No output	AK: ASCII code 06h
1		Output		

■ indicates factory settings.

Class	Item	Parameter	Description
<i>Rout</i> Analog output	<i>Rn</i> Analog output mode	■ 0	2-digit output mode
		1	3-digit output mode
		2	Net full scale output mode
		3	Gross full scale output mode
	<i>SEL</i> Output digit selection	■ 0	First digit
		1	Second digit
		2	Third digit
		3	4th digit
		4	5th digit
		5	6th digit
6	7th digit		
<i>RP Fnc</i> Application			(Refer to instruction manual of main unit)
<i>MW Fnc</i> Alarm function for minimum weighing value			
<i>Unit</i> Unit			
<i>dS Fnc</i> Density function			
<i>id</i> ID number			
<i>PASSwd</i> Password lock			
<i>Ruto CAL</i> ※ Automatic calibration			
<i>CS in</i> ※ Internal mass value correction			(Refer to instruction manual of main unit)

■ indicates factory settings. ※ : Settings for GX-A series.

6. GXA-03 Isolated RS-232C interface

This isolated RS-232C interface is used to communicate with peripherals.

- ※ Connect the AC adaptor to this option (GXA-03) when AD-8529R-W or AD-8529PC-W is used.
- ※ Refer to the instruction manual of main unit concerning function of RS-232C

6.1. Specifications of Serial Interface

This interface is DCE. Use straight cable to connect to a computer (DTE).

Transmission system	EIA RS-232C		
Transmission	Asynchronous, bi-directional, half-duplex		
Data format	Baud rate:	600, 1200, 2400, 4800, 9600, 19200, 38400 bps	
	Data bits:	7 bits or 8 bits	
	Parity bit:	Even, Odd	(Data length 7 bits)
		None	(Data length 8 bits)
	Stop bit:	1 bit	
	Code:	ASCII	
Connector	D-Sub9 pin [male]		

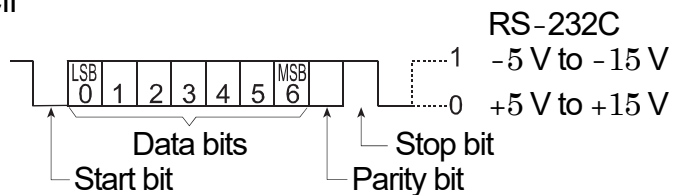

Pin assignments

Pin No.	Signal	Direction	Description
1	-		N.C. No connection
2	RXD	Output	Transmit data
3	TXD	Input	Receive data
4	-		N.C. No connection
5	SG		Signal ground
6	DSR	Output	Data set ready
7	RTS	Input	Request to send
8	CTS	Output	Clear to send
9	-		N.C. No connection

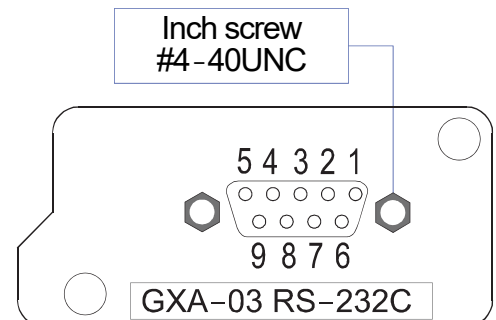

Signal names are those of the DTE side.

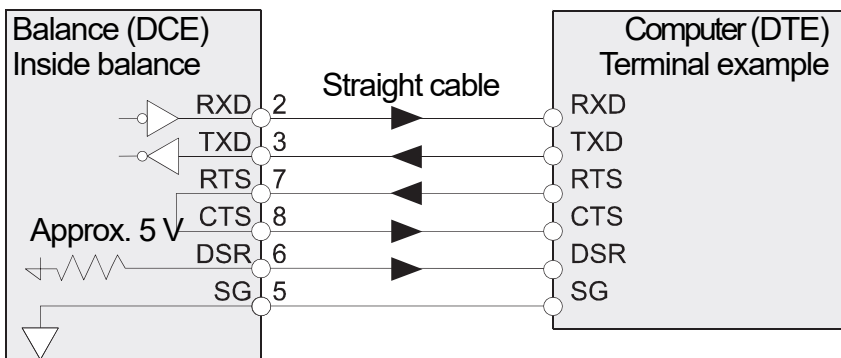

7. GXA-04 Comparator Output

The comparator output (GXA-04) has the function to compare between the weighing value and preset second upper limit, upper limit, lower limit or second lower limit. The result of comparison can be output to the contact. When the contact is shorted, this option can select whether or not to sound the buzzer.

- Optional foot switch (AX-SW137-PRINT, AX-SW137-RE-ZERO) or other external switches can be used.

7.1. Specifications of Comparator Output

Maximum contact voltage: 50 V DC
 Maximum contact current: 100 mA DC
 Maximum contact resistance: 20 Ω
 Output connector Compatible plug : 8 pin mini DIN connector [Female](Accessory)
 E8-200J-100 or equivalent
 External contact input connector Compatible plug : φ3.5 mm 3 pole mini stereo jack
 MP-013LC or equivalent parts

Panel External View

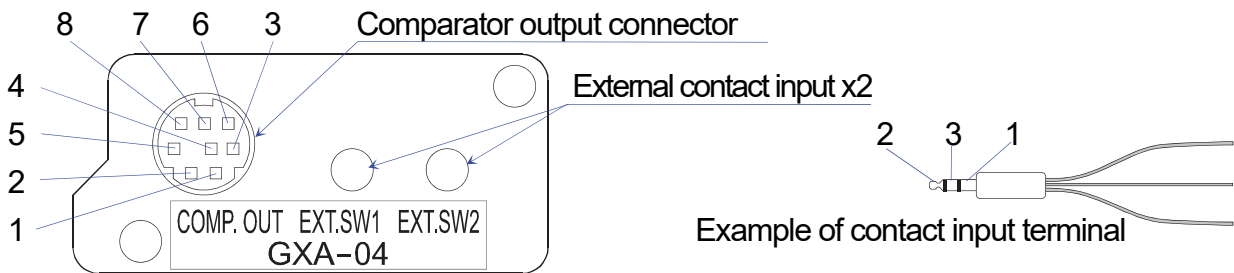

Comparator output circuit

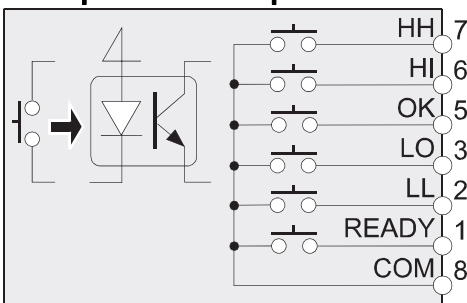

Pin assignments and wire colors of accessory cable

Pin No.	Description	Wire color
1	READY Output	Red
2	LL Output	White
3	LO Output	Black
4	N . C . No connection	Yellow
5	OK Output	Blue
6	HI Output	Green
7	HH Output	Brown
8	COM	Gray
Housing	Case	Shield

External contact input circuit

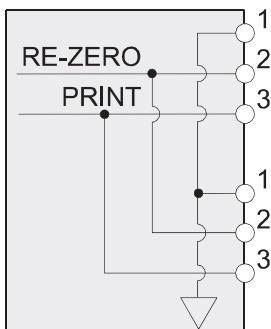

Pin No.	Description
1	GND
2	RE-ZERO External contact input
3	PRINT External contact input

Optional foot switch can connect to either input.

Using External Contact Input

When 1 pin and 3 pin or 1 pin and 2 pin of lead wire of optional foot switch (AX-SW137-PRINT, AX-SW137-RE-ZERO) is shorted 100 ms or longer, it can be operated the same as the **PRINT** key and **RE-ZERO** key on the panel.

7.2. Using the Comparator Output

This option can output results of the 3-stage comparison or 5-stage comparison that is specified at "Comparison method ($\boxed{[P-t]}$)" in the function table of the balance.

Comparison results are displayed using **HI**, **OK**, **LO** and are output using contacts of I/O terminals. Comparison tolerance ranges are the following 3 types and they can be specified at "Comparator mode ($\boxed{[P]}$)" in the function table.

"No comparison", "Comparison when stable value or overloaded", or "Comparison always"
The range of near zero can be specified at "Near zero ($\boxed{[P-z]}$)" in the function table.

There are two types of comparison method. One is the method using second upper limit, upper limit, lower limit and second lower limit. Another is the method using center value and tolerance range. There are two types of input methods for second upper limit, upper limit, lower limit and second lower limit. One is the numerical input. Another is the input using sample weight. Balance can sound a buzzer according to the comparison result. That can be specified at "Comparator buzzer ($\boxed{[P-bEEP]}$)" in the function table.

When weighing value is not displayed in performing RE-ZERO, etc., READY contact becomes "open". When weighing value is displayed, READY contact becomes "short".

3-stage comparison result 3-stage comparison – display, contact output

Weighing value Threshold value Formula	Result	Display	Contact output			Buzzer
			HI	OK	LO	
UL $UL < WV$	HI	HI illuminated	Short	Open		bEEP HI
LL $LL \square WV \square UL$	OK	OK illuminated	Short			bEEP OK
$WV < LL$	LO	LO illuminated	Open		Short	bEEP LO

Weighing value: WV, Upper limit: UL, Lower limit: LL

5-stage comparison result 5-stage comparison – display, contact output

Weighing value Threshold value Formula	Result	Display	Contact output					Buzzer
			HH	HI	OK	LO	LL	
SUL $SUL < WV$	HH	HI blinking	Short					bEEP HH
UL $UL < WV \square SUL$	HI	HI illuminated		Short	Open			bEEP HI
LL $LL \square WV \square UL$	OK	OK illuminated			Short			bEEP OK
SLL $SLL \square WV < LL$	LO	LO illuminated		Open		Short		bEEP LO
$WV < SLL$	LL	LO blinking					Short	bEEP LL

Weighing value: WV, Second upper limit: SUL, Upper limit: UL, Lower limit: LL, Second lower limit: SLL

7.3. Comparison Method Selection (Tolerance Range and Center Value or Threshold Values)

Setting Example

Comparison always	[P]	[2]	
5-stage comparison	[P-t]	[1]	
Comparison excluding ±5 digits (counts) from zero	[P-2]	[1]	
Comparison of both polarities	[P-P]	[2]	Factory setting
Center value using numerical input	[P in]	[2]	or
Center value using sample weight	[P in]	[3]	

Procedure

- Step 1 Press and hold the **[SAMPLE]** key to enter the function table.
bASFnC is displayed.
- Step 2 Press the **[SAMPLE]** key to display **[P FnC]** (Comparator).
- Step 3 Press the **[PRINT]** key to enter **[P FnC]** (Comparator).
- Step 4 Press the **[RE-ZERO]** key several times to display **[P] [2]** (Comparison always).
- Step 5 Press the **[SAMPLE]** key to display **[P-t]** (Comparison method).
- Step 6 Press the **[RE-ZERO]** key to display **[P-t] [1]** (5-stage comparison).
- Step 7 Press the **[SAMPLE]** key to display **[P-2]** (Near zero).
- Step 8 Press the **[RE-ZERO]** key several times to display **[P-2] [1]** (Comparison excluding ±5 digits (counts) from zero).
- Step 9 Press the **[SAMPLE]** key several times to display **[P in]** (Input method).
- Step 10 Press the **[RE-ZERO]** key several times to select input method.
[P in] [2] (Center value using numerical input) or,
[P in] [3] (Center value using sample weight)
- Step 11 Press the **[PRINT]** key to store new settings and use them.

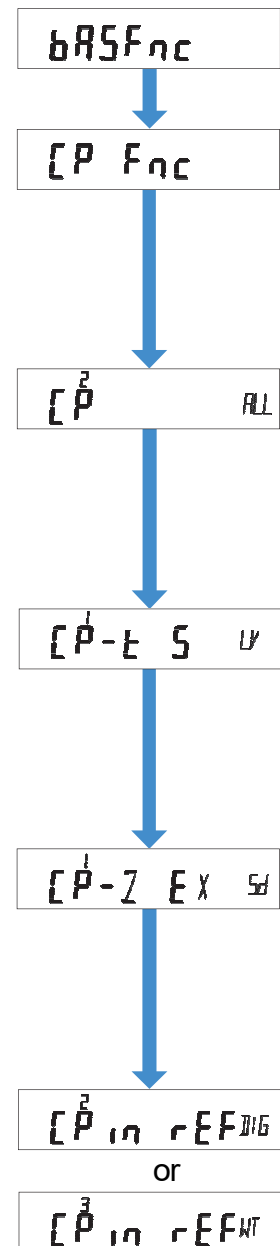

7.4. Setting Threshold Values

This explanation uses $\boxed{[P-t]}$ $\boxed{1}$ (5-stage comparison) and specifies $\boxed{[P, n]}$ $\boxed{0}$ (Threshold value using numerical input) or $\boxed{[P, n]}$ $\boxed{1}$ (Threshold value using sample weight) to $\boxed{[P, n]}$ (input method) in the function table and inputs the threshold value.

Selecting a input method

(If $\boxed{[P, n]}$ $\boxed{0}$ or $\boxed{1}$)

Step 1 Press and hold the $\boxed{\text{SAMPLE}}$ key to enter the function table. $\boxed{\text{bASFc}}$ is displayed.

Step 2 Press the $\boxed{\text{SAMPLE}}$ key several times to display $\boxed{[P \text{ VALUE}]}$ (Comparator threshold value).

Step 3 Press the $\boxed{\text{PRINT}}$ key to enter $\boxed{[P \text{ VALUE}]}$ (Comparator threshold value).

Step 4 Press the $\boxed{\text{SAMPLE}}$ key several times to input threshold value. Refer to the following "Threshold value using numerical input" or "Threshold value using sample weight".

Step 5 If the $\boxed{\text{PRINT}}$ key is pressed when threshold value is displayed, the current parameters are displayed (all digits blinks).

Numerical input of threshold values

(If $\boxed{[P, n]}$ $\boxed{0}$)

Step 6 If changing the parameters, press the $\boxed{\text{RE-ZERO}}$ key to store the following keys.

$\boxed{\text{SAMPLE}}$ key	Moves blinking digit.
$\boxed{\text{RE-ZERO}}$ key	Changes value of blinking digit.
$\boxed{\text{MODE}}$ key	Changes polarity.
$\boxed{\text{PRINT}}$ key	Stores and proceeds to step 7.
$\boxed{\text{CAL}}$ key	Cancels and proceeds to step 7.

If the current parameters will be maintained, press the $\boxed{\text{PRINT}}$ or $\boxed{\text{CAL}}$ key to proceed to step 7.

Step 7 Repeat step 4, 5 and 6 for other threshold values.

Storing threshold values using sample weight

(If $\boxed{[P, n]}$ $\boxed{1}$)

Step 8 Press the $\boxed{\text{RE-ZERO}}$ key to display $\boxed{0.00 \text{ g}}$.

Put the sample on the weighing pan and press the $\boxed{\text{PRINT}}$ key to store weighing value as the threshold value.

$\boxed{\text{RE-ZERO}}$ key	Resets display of the balance to zero .
$\boxed{\text{PRINT}}$ key	Stores weighing value and proceeds to step 9.

Step 9 Repeat step 4, 5 and 6 for other threshold values.

Storing threshold values using RS-232C commands from peripherals

The second upper limit, upper limit, lower limit and second lower limit can be specified using RS-232C commands from peripherals.

Example command	HH: +1000.000␣␣g	second upper limit
	HI: +0800.000␣␣g	upper limit
	LO: +0600.000␣␣g	lower limit
	LL: +0400.000␣␣g	second lower limit
	␣ : space of ASCII code 20 h	

7.5. Setting Center Value and Tolerance Range

This explanation uses $[P-t] [1]$ (5-stage comparison), specifies $[P, n] [2]$ (Center value using numerical input) or $[P, n] [3]$ (Center value using sample weight input) to $[P, n]$ (input method) in the function table, and compares using the center value and numerical input of tolerance range.

Selecting a input method

(If $[P, n] [2]$ or $[3]$)

Step 1 Press and hold the **SAMPLE** key to enter the function table.

$bRSFnC$ is displayed.

Step 2 Press the **SAMPLE** key several times to display $[P VALUE]$ (comparator threshold value).

Step 3 Press the **PRINT** key to display $[P VALUE]$ (comparator threshold value).

Step 4 Press the **SAMPLE** key several times to display "Center value using numerical input" or "Center value using sample weight". Specify the center value, tolerance range and second tolerance range.

Numerical input of center value

(If $[P, n] [2]$)

Step 5 Press the **PRINT** key while displaying $[P rEF]$. The current parameter is displayed (all digits blinking). If parameter does not need to be changed, press the **PRINT** key or **CAL** key and proceed to step 6. If the parameter is to be changed, press the **RE-ZERO** key and change it using the following keys.

SAMPLE key	Moves blinking digit.
RE-ZERO key	Changes value of blinking digit.
MODE key	Changes polarity.
PRINT key	Stores and proceeds to step 6.
CAL key	Cancels and proceeds to step 6.

Step 6 Proceed to "Storing tolerance range from center value using numerical input".

Storing center value using sample weight

(If $[P, n]$ $[3]$)

Step 7 Press the $[PRINT]$ key while displaying $[P, rEF]$. The current parameter is displayed (all digits blinks). Press the $[RE-ZERO]$ key to enter to the sample weight input mode. Press the $[RE-ZERO]$ key to display $[0.00 g]$. Put sample of center value on the pan and press the $[PRINT]$ key. The current parameter can be confirmed (all digits blinking). Press the $[PRINT]$ key to store the center value.

Step 8 Next, $[P, LME]$ is displayed.

Step 9 Proceed to "Storing tolerance range from center value using numerical input".

Storing tolerance range from center value using numerical input

Step 10 Press the $[PRINT]$ key while displaying $[P, LME]$. The current parameter is displayed.

If the tolerance range is to be changed, change it using the following keys.

Input the tolerance range with center value assumed to be 100 %.

$[SAMPLE]$ key	Moves blinking digit.
$[RE-ZERO]$ key	Changes value of blinking digit.
$[PRINT]$ key	Stores and proceeds to step 11.
$[CAL]$ key	Cancels and proceeds to step 11.

Step 11 Press the $[PRINT]$ key while displaying $[P, LME?]$. The current parameter is displayed.

If the second tolerance range is to be changed, change it using the following keys.

Input the second tolerance range with center value assumed to be 100 %.

$[SAMPLE]$ key	Moves blinking digit.
$[RE-ZERO]$ key	Changes value of blinking digit.
$[PRINT]$ key	Stores and proceeds to step 12.
$[CAL]$ key	Cancels and proceeds to step 12.

Step 12 Press the $[CAL]$ key to return to weighing mode.

8. GXA-06 Analog Voltage Output

The analog voltage output (GXA-04) can convert the specified weighing value to analog voltage between 0 and 1 V and output it.

8.1. Specifications of Analog Voltage Output

Analog Voltage Output

Output impedance	100 Ω or less	
Linearity	± 0.3 % or less	
Output connector	Compatible plug:	4 pin mini DIN connector [Female](Accessory) E4-200J-100 or equivalent
Pin connections	Output	4 pin
	GND	3 pin
Output range	0 V to 1 V	With the slide switch set to "0V~"
	0.2 V to 1 V	With the slide switch set to "0.2V~"
Input impedance of the device connected	10 k Ω or greater	

Panel External View

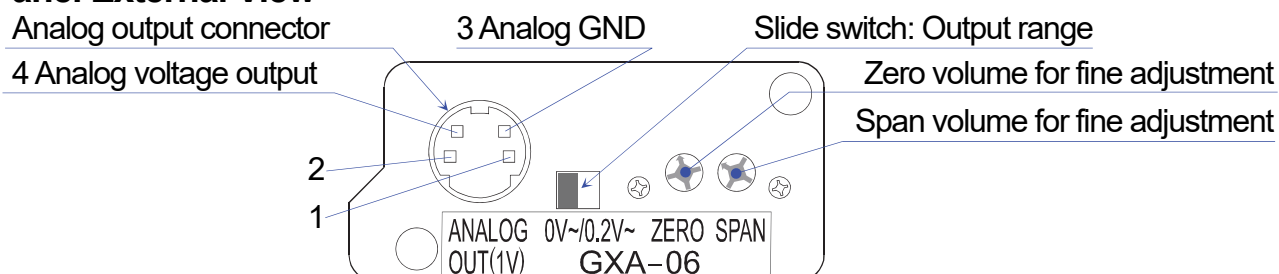

Output circuit

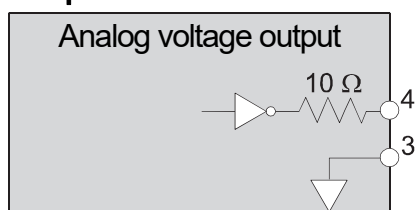

Pin assignments and wire colors of accessory cable

Pin No.	Description	Wire color
1	N.C. No connection	Black
2	N.C. No connection	Blue
3	Analog GND (0 V)	Red
4	Analog voltage output	White
Housing	Case	Shield

8.2. Function Table of Analog Voltage Output

R_{out} of the function table can be selected when this option is connected.

R_{out} Analog output

Item	Parameter	Description
R_n Analog output mode	■ 0	2-digit output mode Converts 2 consecutive digits with minimum digit selected by SEL to voltage.
	1	3-digit output mode Converts 3 consecutive digits with minimum digit selected by SEL to voltage.
	2	Net full scale output mode Outputs 0.000 V when the net weight is zero. Outputs 1.000 V when the net weight is full scale. Output is 0.000 V when zero is set using the $RE-ZERO$ key.
	3	Gross full scale output mode Outputs 0.000 V when the gross weight is zero. Outputs 1.000 V when the gross weight is full scale. Tare operation using the $RE-ZERO$ key will not affect the output. (Note: If tare is extremely light, tare operation might change the zero point. Thus affecting the output.)
SEL Output digit selection		Specify minimum digit to be output at R_n mode. When R_n is set to 0 or 1, the setting is in effect.
	■ 0	Specify first digit as minimum digits.
	1	Specify second digit as minimum digits.
	2	Specify third digit as minimum digits.
	3	Specify 4th digit as minimum digits.
	4	Specify 5th digit as minimum digits.
	5	Specify 6th digit as minimum digits.
6	Specify 7th digit as minimum digits.	

■ indicates factory settings.

Example

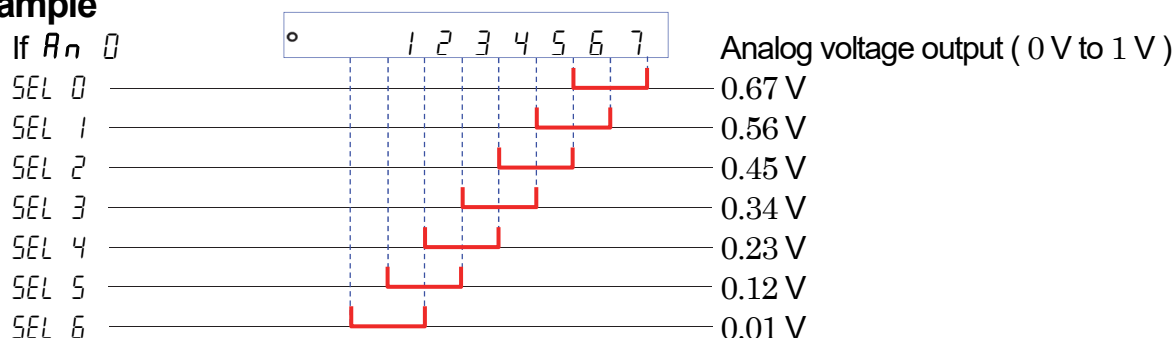

Caution The hidden high-order digits are regarded as zero.

The hidden least significant digit is regarded as zero (when the least significant digit is hidden using the $SAMPLE$ key).

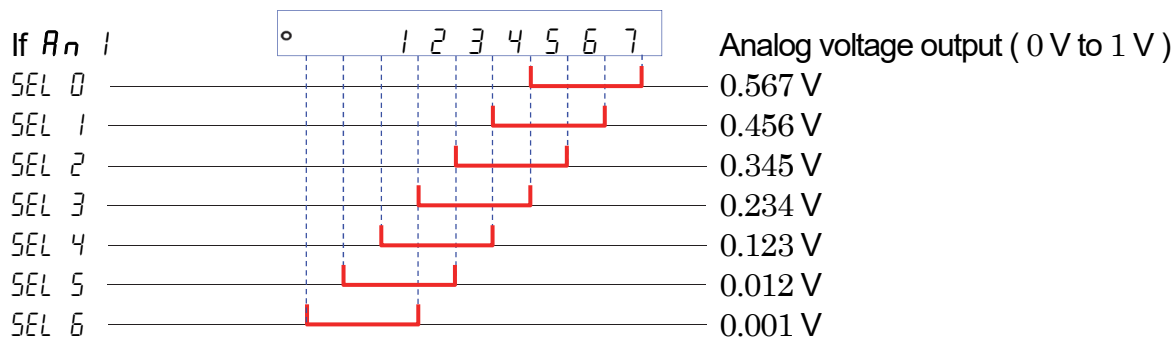

If $\overline{R_n} 2$ or $\overline{R_n} 3$

Model	Full scale
GX-203A	220 g
GX-303A	320 g
GX-403A	420 g
GX-603A	620 g
GX-1003A	1100 g
GX-1603A	1620 g
GX-2002A	2200 g
GX-3002A	3200 g
GX-4002A	4200 g
GX-6002A	6200 g
GX-6001A	6200 g
GX-10001A	10200 g

Model	Full scale
GF-203A	220 g
GF-303A	320 g
GF-403A	420 g
GF-603A	620 g
GF-1003A	1100 g
GF-1603A	1620 g
GF-2002A	2200 g
GF-3002A	3200 g
GF-4002A	4200 g
GF-6002A	6200 g
GF-6001A	6200 g
GF-10001A	10200 g

Example When the GX-2002A displays 200 g, the voltage output of $\overline{R_n} 2$ is 0.1 V.
(Using "0V~" of the slide switch)

$$1.000 \text{ V} \times \frac{200 \text{ g}}{2000 \text{ g}} = 0.100 \text{ V}$$

Caution "Full scale" of the full scale output mode indicates the full scale values shown in the tables above. The output voltage may exceed 1.000 V, depending on the weighing value.

Example When the GX-2002A displays 2200 g, the voltage output is 1.1 V.
(Using "0V~" of the slide switch)

$$1.000 \text{ V} \times \frac{2200 \text{ g}}{2000 \text{ g}} = 1.100 \text{ V}$$

8.3. Voltage Output Selection

The range of output voltage can be change using the slide switch on the panel.

Factory settings is "0V~".

- "0V~" (0 to 1 V) : Zero 0.000 V, full scale 1.000 V
- "0.2V~" (0.2 to 1 V) : Zero 0.200 V, full scale 1.000 V

Panel External View

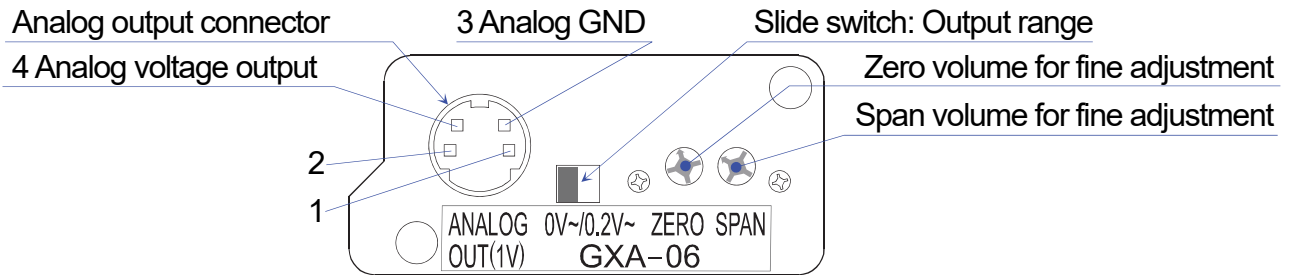

8.4. Voltage Output Fine Adjustment

The voltage output has been adjusted at the factory before shipment.

Using the ZERO volume and SPAN for fine adjustment and a voltmeter, voltage output can be finely adjusted.

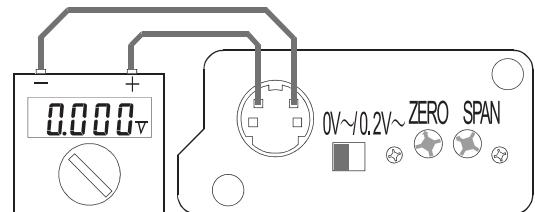

Procedure

Step 1 Turn off the display using the **ON:OFF** key.

Voltage output becomes zero point status.

Adjust the ZERO volume so that the voltmeter indicates 0.000 V (when the slide switch is set to "0V~").

Adjust the ZERO volume so that the voltmeter indicates 0.200 V (when the slide switch is set to "0.2V~").

The display to output 0 V (0.2 V).



Step 2 While pressing and holding the **PRINT** and **SAMPLE** keys, press the **ON:OFF** key to enter the initializing mode. Then 1 V is output. Adjust the SPAN volume so that the voltmeter indicates 1.000 V

The display to output 1 V.

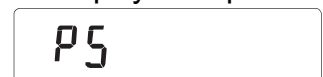

Step 3 Repeat step 1 and step 2 until the correct voltage output is obtained.

8.5. Fixed Voltage Output

The voltage output is fixed under the following conditions:

- With the display off, 0 V is output (or 0.2 V if the slide switch is set to "0.2V~") when not weighing during calibration, etc..
- During the re-zeroing operation in gross full scale output mode ($\boxed{R_n} \boxed{3}$), the previous output value is retained.
- During the re-zeroing operation in 2-digit output mode ($\boxed{R_n} \boxed{0}$), 0 V is output (or 0.2 V if the slide switch is set to "0.2V~").
- During the re-zeroing operation in 3-digit output mode ($\boxed{R_n} \boxed{1}$), 0 V is output (or 0.2 V if the slide switch is set to "0.2V~").
- During the re-zeroing operation in Net full scale output mode ($\boxed{R_n} \boxed{2}$), 0 V is output (or 0.2 V if the slide switch is set to "0.2V~").
- When $\boxed{-E}$ (weighing value is negative overload) is displayed, 0 V is output (or 0.2 V if the slide switch is set to "0.2V~").
- When \boxed{E} (weighing value is positive overload) is displayed, the following voltages are output.

Example Voltage output when \boxed{E} is displayed if the slide switch is set to "0V~".

Model	$\boxed{R_n} \boxed{0}$,	$\boxed{R_n} \boxed{2}$,
	$\boxed{R_n} \boxed{1}$	$\boxed{R_n} \boxed{3}$
GX-203A	1.000 V	1.100 V
GX-303A	1.000 V	1.067 V
GX-403A	1.000 V	1.050 V
GX-603A	1.000 V	1.033 V
GX-1003A	1.000 V	1.100 V
GX-1603A	1.000 V	1.013 V
GX-2002A	1.000 V	1.100 V
GX-3002A	1.000 V	1.067 V
GX-4002A	1.000 V	1.050 V
GX-6002A	1.000 V	1.033 V
GX-6001A	1.000 V	1.033 V
GX-10001A	1.000 V	1.020 V

Model	$\boxed{R_n} \boxed{0}$,	$\boxed{R_n} \boxed{2}$,
	$\boxed{R_n} \boxed{1}$	$\boxed{R_n} \boxed{3}$
GF-203A	1.000 V	1.100 V
GF-303A	1.000 V	1.067 V
GF-403A	1.000 V	1.050 V
GF-603A	1.000 V	1.033 V
GF-1003A	1.000 V	1.100 V
GF-1603A	1.000 V	1.013 V
GF-2002A	1.000 V	1.100 V
GF-3002A	1.000 V	1.067 V
GF-4002A	1.000 V	1.050 V
GF-6002A	1.000 V	1.033 V
GF-6001A	1.000 V	1.033 V
GF-10001A	1.000 V	1.020 V



A&D Company Limited

3-23-14 Higashi-Ikebukuro, Toshima-ku, Tokyo 170-0013, JAPAN
Telephone: [81] (3) 5391-6132 Fax: [81] (3) 5391-1566

A&D ENGINEERING, INC.

1756 Automation Parkway, San Jose, California 95131, U.S.A.
Telephone: [1] (408) 263-5333 Fax: [1] (408) 263-0119

A&D INSTRUMENTS LIMITED

Unit 24/26 Blacklands Way, Abingdon Business Park, Abingdon, Oxfordshire OX14 1DY United Kingdom
Telephone: [44] (1235) 550420 Fax: [44] (1235) 550485

A&D AUSTRALASIA PTY LTD

32 Dew Street, Thebarton, South Australia 5031, AUSTRALIA
Telephone: [61] (8) 8301-8100 Fax: [61] (8) 8352-7409

A&D KOREA Limited

한국에이.엔.디(주)

서울특별시 영등포구 국제금융로6길33 (여의도동) 맨하탄빌딩 817 우편 번호 07331
(817, Manhattan Bldg., 33. Gukjegeumyung-ro 6-gil, Yeongdeungpo-gu, Seoul, 07331 Korea)
전화: [82] (2) 780-4101 팩스: [82] (2) 782-4264

ООО A&D RUS

ООО "ЭЙ энд ДИ РУС"

121357, Российская Федерация, г.Москва, ул. Верейская, дом 17
(Business-Center "Vereyskaya Plaza-2" 121357, Russian Federation, Moscow, Vereyskaya Street 17)
тел.: [7] (495) 937-33-44 факс: [7] (495) 937-55-66

A&D INSTRUMENTS INDIA PRIVATE LIMITED

ऐ&डी इन्स्ट्रूमेन्ट्स इण्डिया प्रा० लिमिटेड

509, उद्योग विहार , फेस -5, गुडगांव - 122016, हरियाणा , भारत
(509, Udyog Vihar, Phase-V, Gurgaon - 122 016, Haryana, India)
फोन : 91-124-4715555 फैक्स : 91-124-4715599