

**Dynamic Strain Amplifier**  
**AS3000 series**  
**AC Strain Amplifier**

**Instruction Manual**

## CAUTION

- (1) Turn off the power when an error occurs in behavior of product.  
If it is impossible to trace the causes of an abnormal operation, please contact our sales representative.
- (2) The contents of this manual are subject to change without notice.
- (3) This manual is copyrighted with all rights reserved. This manual may not be reproduced, modified, or translated without the written permission of A&D Company, Limited. No parts of this manual may be transcribed without permission.
- (4) Please let us know if there are any points that are unclear or missing in this manual.
- (5) A&D Company, Limited. will not be held responsible for any damages or loss of income caused by the operation of this device or any direct, indirect, special, or inevitable damages caused by defects in the product, even if there is notice that the corresponding damages may occur. We will also not be held responsible for any third-party claims of rights. At the same time, we will not be held responsible for any loss of data. We will not be held responsible for any of such points as those indicated in item (4).

© 2023 A&D Company, Limited.

- Product names and company names in this manual are trademarks or registered trademarks of their respective owners in Japan and other countries.

## Introduction

We thank you for your purchase of our AC strain amplifier AS3000 series.

Please read this manual and operate this amplifier correctly when operating this amplifier.

This manual presents necessary knowledge to operate correctly and to use safely.

Please keep this manual with the amplifier. If you have any question of this manual, please contact your dealer.

### Confirming Contents of Package

When the package is opened in a warm room during the cold season, it may be cause of malfunction due to condensation on the surface of the product. Open the package after it has reached room temperature. The amplifier has been thoroughly inspected before shipping, verify any external damage of the amplifier when receiving it. Also, examine the specifications and accessories of the amplifier. If there are any missing and damaged items, please contact your dealer.

#### <Packing List>

Name	Model / document number	Quantity	Remarks
Main unit	AS3000	1	AC 100 V to 240 V
AC power supply cable		1	Cable selected when ordering the product
Output cable	AS30-503	1	BNC-crocodile clip (red, black) 2 m
Adjustment driver		1	
Simplified manual label		1	Manual for indications and operations.
This manual	1WMPD4004825	1	Descriptions of cautions and operations.

※ Refer to plug type and power supply voltage.



<https://www.iec.ch/world-plugs/>

# To Safely Use Products



## Safety measures – warnings and cautions

Be sure to observe the following instructions when using this amplifier. Additionally, the warranty does not cover damages resulting from the actions against instructions, cautions, or warnings mentioned in this manual. This manual describes the following items to ensure the safety use of the amplifier.

## Meaning of warning signs

 <b>WARNING</b>	This indicates a condition or practice that could result in personal injury or loss of life, or may result in light injury or physical damage if this equipment is misused due to neglect of a Warning.
 <b>CAUTION</b>	This indicates a condition or practice that could result in light injury or damage to the equipment or other property if this equipment is misused due to neglect of a Caution.

## Meanig of symbols

	<p>△ symbols indicate cautions (including warnings). Specific precautions are indicated inside figures (in the example on the left, a warning about electrocution).</p>
	<p>⊘ symbols indicate prohibited actions. Specific prohibited actions are indicated inside ⊘ or with nearby text or pictures. The example on the left indicates that disassembly is prohibited.</p>
	<p>● symbols indicate actions that must be taken. Specific actions that must be taken are indicated inside ● or with nearby text or pictures. The example on the left indicates an action that must be taken.</p>

**WARNING**

**Power supply**

- ❑ Make sure that the power supply is within the rating indicated on the rating plate attached to this amplifier. If any voltage exceeding the rated voltage was supplied, there would be risk of damage to this amplifier, or even a fire. Also, in order to prevent electric shock and hazards such as a fire, be sure to use only the AC power cable supplied with this amplifier.

**Protective grounding and protective function**

Be sure to ground this amplifier before supplying power. Protective grounding is necessary to use this amplifier safely, as well as to protect the user and peripheral equipment from injury or damage. Be sure to observe the following instructions:

- ❑ Protective grounding  
This amplifier uses a 3-pin AC outlet with a ground pole to prevent electric shock. Use the power cable equipped with protective grounding terminal. When 2-pin to 3-pin adapter is used, be sure ground with the protective grounding terminal or ground with the grounding wire of adapter.
- ❑ Caution of protective grounding  
While the power is supplied to the product, do not cut or remove the protective grounding line. Otherwise, safety of the product is not guaranteed.
- ❑ Defect of protective function  
If you find defect at protective function of protective grounding, do not use this amplifier. Confirm that there isn't defect of protective function before use.

 **WARNING****Use, storage and installation in gaseous atmosphere**

- Never use, store and install this amplifier in a flammable or explosive atmosphere, or an atmosphere containing steam. Such atmosphere causes user and the amplifier fall into danger.

**Disassembling the frame**

- It is dangerous to remove the frame of this amplifier.  
The selection of AC 100 V system / AC 200 V system can be switched with the [AC power supply **voltage selector**] switch on the bottom of the amplifier. Don't remove the cover of the amplifier.  
The frame must not be removed from the amplifier other than by our service engineers.

**Connection of input signals**

- Connect the input terminal after connecting certainly the protective grounding terminal of the amplifier.  
To prevent receiving an electric shock and burning accident, confirm that an input signal and common mode voltage are not inputted when wiring the input wire, operate them.

**Precautions during operation**

- When the amplifier is used, voltage between the input terminal and grounding terminal and voltage between the input terminal and output terminal may become high voltage. Be careful of receiving electric shock accident during operation.

**Installation category and pollution degree**

- This amplifier is overvoltage category II and pollution degree II.  
Confirm that power supply voltage is within rated voltage of this amplifier, connect power cable to this amplifier.

 **CAUTION**

**Cautions of handling**

When using this product, always follow the precautions below. Improper handling may lead to erroneous operations and damages.

Necessary conditions of user

Users who are not familiar with the operation of this product should avoid using it.

Conditions of storage environments

Store the amplifier in the following storage environments.

Storage temperature range : -20 to 70 °C,

Storage humidity range : 10 to 90 %RH (no dew condensation)

Conditions of operating environments

Use the amplifier in the following operating environments.

Storage temperature range : -10 to 50 °C,

Storage humidity range : 20 to 85 %RH (no condensation)

Places that should avoid storage and operating

Avoid storage, setting and operating of the amplifier at the following locations.

- Locations where receives direct sunshine in summer for long time.  
Locations where temperature rises excessively (inside automobile etc.).
- Around heat sources radiating high temperature.
- Locations where the temperature and humidity rise due to direct sunlight or heaters. Locations where dew is condensation.
- Wet locations.
- Locations where salt, oil, or corrosive gases exist.
- Dusty locations. High humidity locations.
- Locations subject to strong vibrations.
- Locations where receives excessive impact.
- Slanted locations.
- Dangerous locations.

Cautions for using power supply.

- Be careful of power voltage fluctuations. Do not use the product when these are likely to exceed the rated voltage.
- If the power supply includes a lot of noise or high-voltage inductive noise, use noise filters to avoid operation errors.

Calibration

Calibrate the amplifier to maintain accuracy of the amplifier periodically at least each year.

If necessary, contact your dealer to do a fee-charging calibration.

## Caution in Handling

Read this manual before using the amplifier.

- Do not input voltage and electric current from peripherals to the output terminal.
- Use either power supply of AC100 V to 120 V or AC200 V to 240 V and/or DC10 V to 30 V.  
The amplifier has the [AC power supply **voltage selector**] switch on the bottom. When the power supply voltage is changed, refer to the "[7.2. Changing AC Voltage of Power Supply](#)". In addition, When the amplifier doesn't turn on even if power is supplied, the [AC power supply **voltage selector**] switch may be "OFF" position. As another case, the amplifier may be malfunction or built-in fuse may break off. Do not disassemble the amplifier, contact your dealer. Others, turn off the power and contact your dealer when you find a trouble of the amplifier.
- Use the amplifier in the following operating environments  
Operation temperature range: -10 to 50 °C, Operation humidity range: 20 to 85 %RH (no condensation)  
In case of bringing out and using the amplifier stored in high humidity and low temperature, use it after equilibrating it to environments because it is prone to condensation.
- In case of using multiple-channels, consider cooling, does not use with fan unit etc.
- Ground the amplifier when it is used.
- The amplifier is equipped flash memory. Therefore, it is not necessary to replace battery.
- The bridge power supply (BV) of the AS3000 series adopts AC signal (alternating current voltage). Use the same frequency to the others in the same storage case. The case is unable to mix different frequency. In addition, even if the same frequency is used to multiple amplifiers that are installed in contiguity with, make synchronization because it may occur noise like beat etc. Refer to "[3.6. How to Use the Storage Case](#)".
- The bridge power supply (BV) is outputted between terminal A and C of the INPUT connector 6.  
Don't short wires from the INPUT connector 6.
- Don't input voltage and current with the exception of sensors and bridge circuit.
- Carry the amplifier using dedicated packing box or a box that wraps it with cushions when transporting it.
- Don't block air ventilation of ventilation holes. Don't insert a sharp thing into ventilation holes. It may cause of malfunctions.

## Warranty

### Warranty – general

We ship our products after conducting quality control, which covers from design to manufacturing. It is, however, possible that failures may occur in the products. If the product does not operate correctly, please make a check of the power supply, cable connections, or other conditions before returning this product to us.

For repair or calibration, contact your dealer. Before returning, be sure to inform your dealer of the model (AS3000), serial number, and problematic points. The following is our warranty.

### Limited warranty

Warranty period: One year from our shipment.

Warranty scope: The warranty only covers the main unit of the product.

We will repair the defects of our product free of charge within the warranty period; however, this warranty does not apply in the following cases.

- Damage or faults caused by incorrect use
- Damage or faults caused by fire, earthquake, traffic accident, or other natural disasters.
- Damage or faults caused by a repair or modification that is carried out by someone other than a service representative of A&D company.
- Damage or faults caused by use or storage in environmental conditions that should be avoided.
- Periodical calibration.
- Damage or faults caused during transportation after delivery.

Liability: We do not assume any liability for equipment other than A&D equipment.

## Disposing of the Used Product

### In the European Union

EU-wide legislation as implemented in each Member State requires that used electrical and electronic products carrying the mark (of right side) must be disposed of separately from normal household waste. This includes electrical accessories, such as chargers or AC adapters. The mark on the electrical and electronic products only applies to the current European Union Member States.

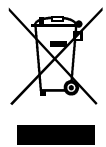

### Outside the European Union

If you wish to dispose of used electrical and electronic products outside the European Union, please contact your local authority and ask for the correct method of disposal.



# CONTENTS

Introduction .....	3
Confirming Contents of Package .....	3
To Safely Use Products .....	4
Caution in Handling .....	7
Warranty .....	8
Disposing of the Used Product .....	8
1. Overview .....	11
1.1. Features .....	11
1.2. Models .....	11
1.3. Block Diagrams of Measurement .....	12
1.4. Features of Dynamic Strain Amplifier .....	12
2. Names and Functions of Each Parts .....	14
2.1. Names and Functions on the Front Panel .....	14
2.2. Names and Functions on the Rear Panel .....	19
2.3. CAL Settings (The setting of calibration value) .....	21
2.4. FNC Settings .....	22
2.5. The BAL Function, Indications in Processing .....	23
2.5.1. The Bridge Check Function (BRC), Indications in Processing .....	24
2.5.2. The Cable Length Compensation Function (CLC), Indications in Processing .....	25
2.5.3. The Automatic Range Function (ARG), Indications in Processing .....	25
3. Measurement Preparation .....	26
3.1. Connecting Cables .....	26
3.1.1. Connecting the Input Cable .....	26
3.1.2. Connecting the Power Cable and Output Cables .....	26
3.1.3. The Switching Function of E terminal (to select connection of shield wire) .....	27
3.2. Consideration for Cable Length .....	28
3.3. Procedure before Measurement .....	28
3.3.1. Operation Procedure .....	28
3.3.2. Measurement Range .....	30
3.4. The Bridge Check Function (BRC) .....	31
3.4.1. Overview .....	31
3.4.2. Error Indication List of Disconnection and Short Circuit .....	32
3.5. Cable Length Compensation Function (CLC) .....	34
3.6. How to Use the Storage Case .....	36
4. Measurement System .....	39
4.1. Precautions before Measurement .....	39
4.2. Connection of Input .....	41
4.2.1. Examples of Bridge Circuit with Strain Gauge .....	41
4.2.2. Bridge Box .....	43
4.2.3. Measurement using Transducer .....	45
4.3. Connection of Output and Load .....	47
4.3.1. Connecting the recorder to the output .....	47
4.4. How to Read Measurement Value .....	48

## CONTENTS

---

4.4.1.	Compensation of Calibration Value (CAL) .....	49
4.5.	Technical Wiring of Bridge Circuit .....	50
4.5.1.	In the case of using spring connections .....	50
4.5.2.	In the case of using differential transformer .....	50
5.	Block Diagram & Operating Principle .....	51
5.1.	Measurement Signal Flow .....	51
6.	Options.....	53
6.1.	Storage Case.....	53
6.1.1.	List of storage case .....	53
6.1.2.	Names of switches and parts on the storage case .....	53
6.1.3.	Installing the amplifier into storage case .....	56
6.1.4.	How to use blank panel .....	56
6.1.5.	Cautions to use the rack mount case .....	57
6.1.6.	How to use mixed with conventional products .....	58
7.	Maintenance .....	60
7.1.	Confirmation Items .....	60
7.2.	Changing AC Voltage of Power Supply.....	62
8.	Specifications.....	63
8.1.	Specifications.....	63
9.	Reference .....	66
9.1.	Characteristics of Frequency and Phase .....	66
9.2.	List of Option Cables .....	69
9.3.	Dimensions .....	70
9.3.1.	Amplifier unit.....	70
9.3.2.	Panel cutout dimensions .....	71
9.3.3.	Bench top case.....	72
9.3.4.	Rack mount case.....	73
9.3.5.	Fan unit.....	74
9.3.6.	Bridge box (5370A type, 5373A type) .....	75
10.	For prolonged use.....	76
11.	Maintenance service.....	76

# 1. Overview

## 1.1. Features

- The AC strain amplifiers of the AS3000 series are equipped the "**Cable length compensation function**" "**Bridge check function**" "**Anti-noise measures**" inherited excellent performance of our own conventional models, newly are equipped the "**Automatic range function**" "**Switching function of E terminal**", are designed so as to be able to perform measurement of high precision and high accuracy safely and to shorten preparation time of dynamic strain measurement.
- The "**Cable length compensation function**" is the function to compensate automatically the voltage drop of the bridge voltage that occurs due to cable length when 4-wire cable is used between the amplifier and sensor bridge.
- The "**Bridge check function**" is the function to detect "disconnection and short circuit in the Wheatstone bridge circuit" and "disconnection of cable between bridge circuit and the amplifier", to indicate them.
- The "**Anti-noise measures**" is the countermeasure to reduce influence of common mode noise and surge noise of the input terminals in the strain gauge measurement. The anti-noise models AS3803, AS3903 are equips it.
- The "**Automatic range function**" is the function to adjust automatically the measurement range so as to fit a preset output voltage when inputting a specified calibration voltage to the internal calibration instrument. The output voltage can select 5 V, 8 V and 10 V.
- The "**Switching function of E terminal**" uses the switch to select the voltage potential of the E terminal wire included in the sensor shield cable, can arrange a shield measure adapted to environment of the part of sensor bridge.
- The FNC settings: Each function can operate including ON/OFF on the front panel.
- Power supply voltage can select either AC100 V system or AC200 V system using the [AC power supply **voltage selector**] switch.

## 1.2. Models

The 5 models of the AS3000 series are designed in accordance with response frequency and noise-resistant type so as to select a best model for physical quantity measurements using strain gauge and strain-gauge transducers.

Table 1 AC Strain Amplifiers

<b>AS3603</b> DC to 2 kHz Response, general purpose type	<b>AS3503</b> DC to 5 kHz Response, general purpose type	<b>AS3703</b> DC to 10 kHz Response, general purpose type	<b>AS3803</b> DC to 2 kHz Response, noise-resistant type	<b>AS3903</b> DC to 5 kHz Response, noise-resistant type
				

Table 2 Storage Case List

Type	Model	Product name	Remarks
Bench top case	AS16-104	4CH Bench top case	Toward to all amplifier units: Calibration input, BAL function, KEY LOCK and main power supply can select ON/OFF. They can interlock and synchronize with other case.
	AS16-105	6CH Bench top case	
	AS16-106	8CH Bench top case	
Rack mount case	AS16-107	8CH Rack mount case	

### 1.3. Block Diagrams of Measurement

The measurement system on the measurement including the amplifier needs consideration and assembling of magnitude of phenomenon (target signal), frequency and measurement time etc. The block diagram of the most commonly used measurement system is as follows:

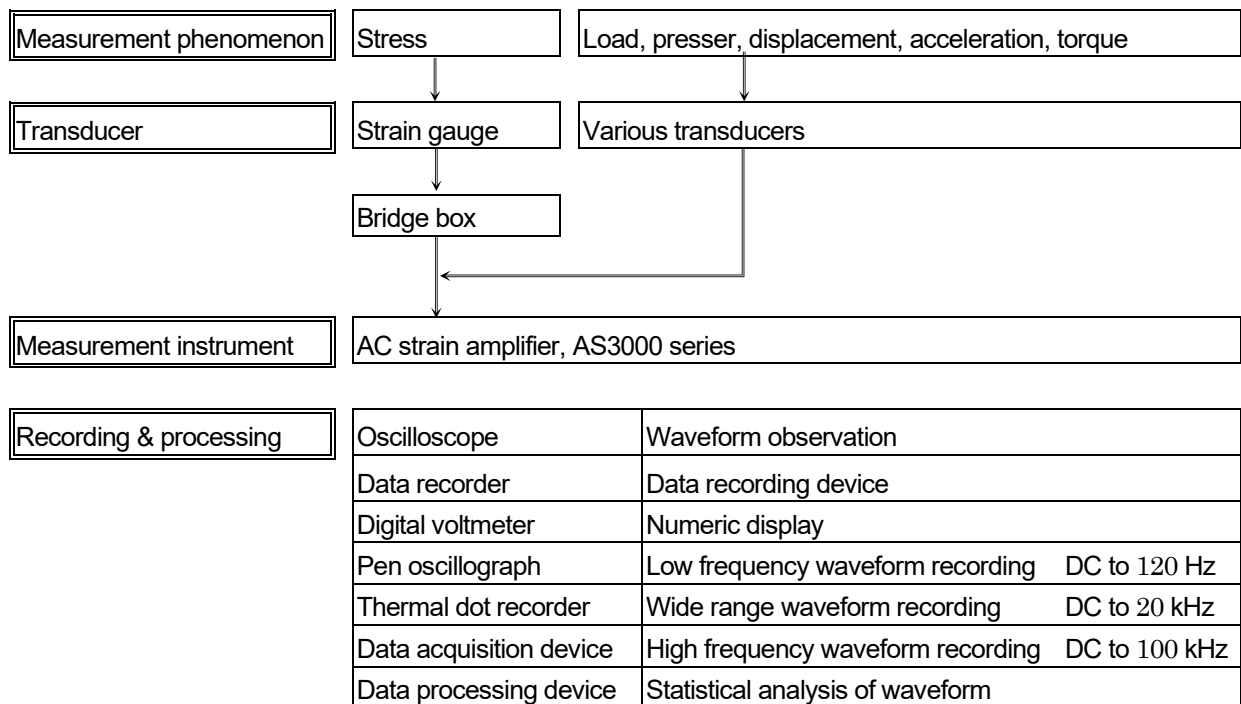

Drawing 1 Block diagram of measurement

### 1.4. Features of Dynamic Strain Amplifier

The "DC power supply system" and "AC power supply system" exist as bridge power supply system (to supply the power to sensor and bridge circuit) for the dynamic strain amplifier.

The "DC power supply system" supplies DC voltage to the bridge circuit and amplifies output signal of the bridge circuit.

The "AC power supply system" supplies AC voltage to the bridge circuit, regards AC frequency as carrier wave and uses the amplitude modulated signal as output signal of the bridge circuit. This modulated signal is amplified and is demodulated at detection circuit.

Table 3 Features of dynamic strain amplifier

Bridge power supply system	DC bridge power supply system	AC bridge power supply system
Bridge power supply	DC 2 V to 10 V	AC 0.5 V, 2 V
Voltage sensitivity (BV = 2 V)	$\pm 1,000$ to $2,000 \mu\text{m/m} \pm 10 \text{ V}$	$\pm 200$ to $500 \mu\text{m/m} / \pm 10 \text{ V}$
Stability of zero point	$\pm 1 \mu\text{m/m}/^\circ\text{C}$ etc.	$\pm 0.1 \mu\text{m/m}/^\circ\text{C}$ etc.
Response frequency	DC to 100 kHz, 500 kHz etc.	DC to 2 kHz, 5 kHz, 10 kHz etc.
Non-linearity	$\pm 0.01 \%$ to $\pm 0.05 \%$	$\pm 0.1 \%$ to $\pm 0.2 \%$
Noise	Susceptible of commercial frequency	Less susceptible of commercial frequency
Principal use	<ul style="list-style-type: none"> <li>⊙ Pressure, displacement, acceleration, torque (transducer).</li> <li>⊙ Impact strain measurement.</li> </ul>	<ul style="list-style-type: none"> <li>⊙ Measurement using strain gauge.</li> <li>○ Pressure, displacement, acceleration, torque (transducer).</li> </ul>
Others	Usage as DC amplifier	When multiple channels are used, synchronization of BV needs.

※ " $\mu\text{m/m}$ " is described as " $\mu\varepsilon$ " on the panel.

Table 4 Selection concerning of model

Kind	AC strain amplifier (Isolation)				
	AS3603 general purpose type	AS3503 general purpose type	AS3703 general purpose type	AS3803 noise-resistant type	AS3903 noise-resistant type
Bridge power supply	AC 0.5 V, 2 V				
Voltage sensitivity (BV = 2 V)	$\pm 200 \mu\text{m/m}$ at $\pm 10 \text{ V}$ output	$\pm 500 \mu\text{m/m}$ at $\pm 10 \text{ V}$ output		$\pm 200 \mu\text{m/m}$ at $\pm 10 \text{ V}$ output	$\pm 500 \mu\text{m/m}$ at $\pm 10 \text{ V}$ output
Sensitivity stability	$\pm 0.02 \%/^\circ\text{C}$			$\pm 0.05 \%/^\circ\text{C}$	
Non-linearity	$\pm 0.1 \%$ of RANGE		$\pm 0.2 \%$ of RANGE	$\pm 0.1 \%$ of RANGE	
Response frequency	DC to 2 kHz	DC to 5 kHz	DC to 10 kHz	DC to 2 kHz	DC to 5 kHz
Noise (BV = 2 V, 120 $\Omega$ )	2 $\mu\text{m/m}$ p-p	5 $\mu\text{m/m}$ p-p	7 $\mu\text{m/m}$ p-p	2 $\mu\text{m/m}$ p-p	5 $\mu\text{m/m}$ p-p
Measurement using strain gauge	⊙				
Measurement using strain gauge transducer	○				
Strain measurement where surge voltage may occur	○			⊙	
Long distance between amplifier and measurement point	⊙ Cable length compensation function				
Impact strain measurement	×				
Usage as DC amplifier	Disabled				

⊙ : Optimum, ○ : Proper, △ : Improper, × : Inappropriate, BV: Bridge power supply voltage

## 2. Names and Functions of Each Parts

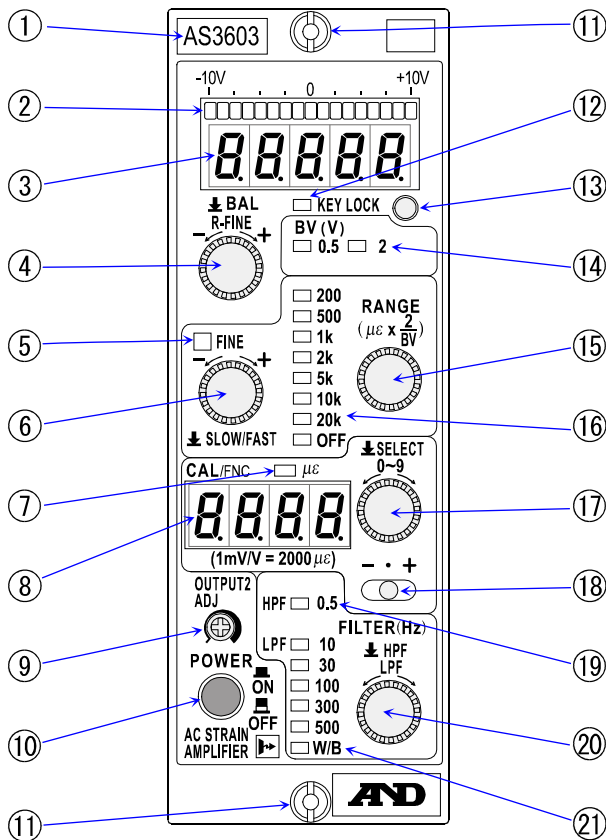

Drawing 2 Front panel

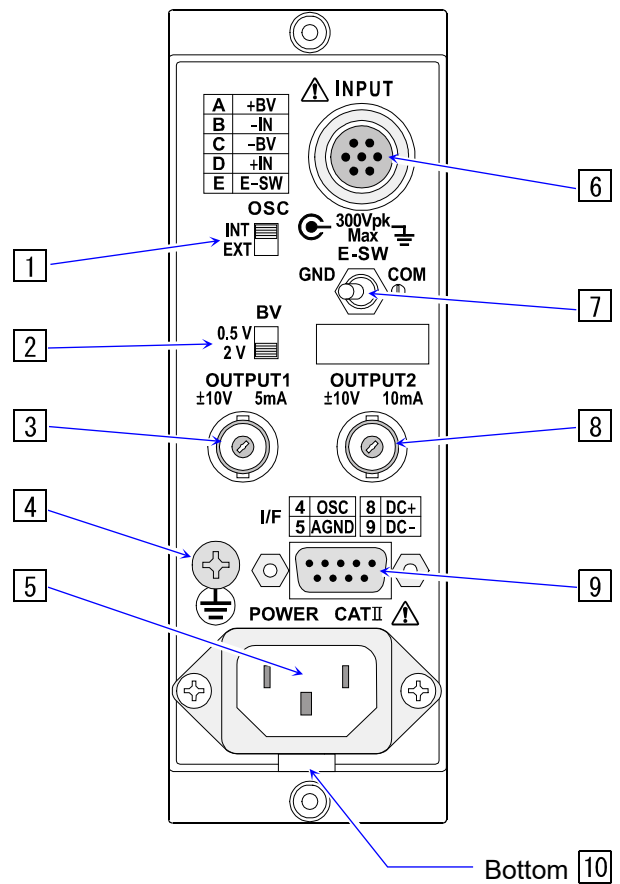

Drawing 3 Rear panel

### 2.1. Names and Functions on the Front Panel

Table 5 2.1. Front panel

No.	Name	Functions, operations and responses
①	Model	AC strain amplifier AS3000 series
②	Level indicator	<ul style="list-style-type: none"> <li>LED bar of 17 dots to monitor output voltage of the OUTPUT ③.</li> <li>When output is within approximate <math>\pm 100</math> mV, green LED of the center indicates.</li> <li>When output exceeds approximate <math>\pm 10.5</math> V, applicable over LED blinks.</li> <li>Right side is positive value and left side is negative value of the OUTPUT ③.</li> </ul>
③	Numeric display	<ul style="list-style-type: none"> <li>The OUTPUT 2 ⑧ is displayed using 4 1/2 numeric LED.</li> <li>When the adjustment volume ⑨ of the OUTPUT 2 is turned fully clockwise, "10.000" at the output 10 V is displayed. (10 V <math>\rightarrow</math> "10.000" display) Example: When the converter of 200 kg to 10 V is uses, it can be adjusted using the adjustment volume ⑨ so as to becomes 200 kg <math>\rightarrow</math> "200.0" display. Refer to the "2.4. FNC Settings".</li> <li>When the FILTER knob ⑳ is pressed and held, last digit of 4 1/2 numeric LED of the OUTPUT 2 display is shown or hidden alternately.</li> </ul>

2. Names and Functions of Each Parts — 2.1. Names and Functions on the Front Panel

No.	Name	Functions, operations and responses
④	BAL knob	
	Bridge check function (BRC) / Cable length compensation function (CLC) / Automatic range function (ARG) / Automatic balance	<ul style="list-style-type: none"> <li>□ When the BAL knob ④ is pressed, the function according to the FNC settings [the bridge check function (BRC), cable length compensation function (CLC) and automatic range function (ARG)] are applied in order, the automatic balance (resistance balance) is executed. Error of capacitance balance has been canceled. Refer to the "2.5. The BAL Function, Indications in Processing" for the details. Refer to the "2.4. FNC Settings" for the FNC settings.</li> <li>□ The result of the bridge check function (BRC) is displayed at Numeric display ③. When disconnection and short circuit aren't detected, <span style="border: 1px solid black; padding: 2px;">Good</span> is displayed.</li> <li>□ When disconnection or short circuit are detected, <span style="border: 1px solid black; padding: 2px;">Error</span> is displayed and failure point is indicated repeatedly. Repair an indication point. Refer to the "3.4. The Bridge Check Function (BRC)".</li> <li>□ The cable length compensation function (CLC) displays a drop rate at the bridge power supply voltage and compensates dropped voltage. Refer to "3.5. Cable Length Compensation Function (CLC)" for the details.</li> <li>□ The automatic range function (ARG) stores output voltage to the FNC settings. Set the RANGE knob ⑮ to "OFF". ("OFF" of LED ⑯ lights.) When the BAL knob ④ is pressed, this (ARG) function is executed. <b>If the RANGE knob ⑮ isn't "OFF", this (ARG) function isn't executed.</b></li> <li>□ Press and hold the BAL knob ④ when stopping error message of the bridge check function (BRC) that is displayed repeatedly.</li> </ul>
	R-FINE	<ul style="list-style-type: none"> <li>□ The resistance balance can be adjusted when turning the BAL knob ④. The output changes to positive direction when turning the BAL knob ④ clockwise. The output changes to negative direction when turning the BAL knob ④ counterclockwise.</li> </ul>
⑤	FINE LED Fine adjustment LED	Both LEDs turn on while the FINE knob ⑥ is FAST fine adjustment. Lower LED turns on while the FINE knob ⑥ is SLOW fine adjustment. Both LEDs turn off while fine adjustment isn't used.

## 2. Names and Functions of Each Parts — 2.1. Names and Functions on the Front Panel

No.	Name	Functions, operations and responses
⑥	FINE knob	
	Fine adjustment of measurement range	<ul style="list-style-type: none"> <li>□ When the FINE knob ⑥ is turned, either SLOW fine adjustment or FAST adjustment is executed. The measurement range becomes narrow range (high sensitivity) when the FINE knob ⑥ is turned clockwise. The measurement range becomes wide range (low sensitivity) when the FINE knob ⑥ is turned counterclockwise. The FINE LED ⑤ turns on while the fine adjustment and turns off when the fine adjustment isn't used.</li> <li>□ Because the FINE knob ⑥ and measurement range are interlocking, when the knob is turned continuously and measurement range is exceeded, the RANGE changes automatically and is reflected in the RANGE LED ⑯. The fine adjustment of measurement range is maintained even if the RANGE knob ⑮ is changed and is set to "OFF".</li> <li>□ Press and hold the FINE knob ⑥ when resetting the fine measurement. Then the LED ⑤ turns off.</li> </ul>
	SLOW / FAST Speed selection	<ul style="list-style-type: none"> <li>□ The speed of the fine adjustment changes to SLOW or FAST when the FINE knob ⑥ is pressed each time.</li> <li>□ While adjustment of resistance balance with the BAL knob ④, speed is selected SLOW always.</li> </ul>
⑦	Unit $\mu\epsilon$ LED	<p>The unit LED <math>\mu\epsilon</math> turns on while the CAL setting mode. The unit LED <math>\mu\epsilon</math> turns off while the FNC setting mode.</p>
⑧	Numerical display for calibration value and setting value	<p>The 4 numeric LED displays a setting value and value selected using the SELECT knob ⑰.</p> <p>The calibration value is displayed in the CAL setting mode. The setting value of each function is displayed in the FNC setting mode.</p>
⑨	OUTPUT 2 adjustment volume	<ul style="list-style-type: none"> <li>□ The output voltage of the OUTPUT 2 ⑧ can adjust between rated 10 V and approximate 1 V. Use accessory adjustment screwdriver.</li> <li>□ The output value is displayed in the numeric display ③ that can use as indicator. Refer to the "<a href="#">2.4. FNC Settings</a>" for decimal position setting.</li> </ul>
⑩	[Power] switch	<p>Either power supply to this amplifier or shutdown of power can be selected when the [Power] switch ⑩ is pressed every time.</p>
⑪	Knurling screws	<p>The amplifier can install and fix into the storage case and panel mount window using upper and lower knurling screws ⑪.</p>
⑫	Key lock LED	<p>The KEY LOCK LED ⑫ turns on while the KEY LOCK is used. The KEY LOCK LED ⑫ turns off while the KEY LOCK isn't used.</p>
⑬	[Key lock] switch	<ul style="list-style-type: none"> <li>□ When the [Key lock] switch ⑬ is pressed and held for 1 second or more, "locked" and "unlock" are switched each time. The KEY LOCK LED ⑫ turns on while key lock is used.</li> <li>□ Target of key lock: BAL knob ④, RANGE knob ⑮, FINE knob ⑥, SELECT knob ⑰, FILTER knob ⑳.</li> <li>□ The [Input of calibration value] switch ⑱ can always use.</li> </ul>



2. Names and Functions of Each Parts — 2.1. Names and Functions on the Front Panel

No.	Name	Functions, operations and responses
⑭	Bridge power supply LED	The LED ⑭ of bridge power supply voltage (BV) (of 0.5 V or 2 V) turns on. Use the [BV] switch ② of rear panel for the voltage selection.
⑮	RANGE knob Measurement range selection	The measurement range can be selected. Refer to the "3.3.2. Measurement Range" for the details. The measurement range becomes narrow range (high sensitivity) when the RANGE knob is turned clockwise. The measurement range becomes wide range (low sensitivity) when the RANGE knob is turned counterclockwise.
⑯	RANGE LED Measurement range LED	The RANGE LED ⑯ indicates a measurement range. Refer to the "3.3.2. Measurement Range" for the details. Measurement range of the AS3603, AS3803: Output $\pm 10$ V/ $\pm 200,000$ $\mu\text{m}/\text{m}$ to Output $\pm 10$ V/ $\pm 200$ $\mu\text{m}/\text{m}$ Measurement range of the AS3503, AS3703, AS3903: Output $\pm 10$ V/ $\pm 500,000$ $\mu\text{m}/\text{m}$ to Output $\pm 10$ V/ $\pm 500$ $\mu\text{m}/\text{m}$ <input type="checkbox"/> " $\mu\text{m}/\text{m}$ " is described as " $\mu\epsilon$ " on the panel.
⑰	SELECT knob CAL setting mode (Settings of calibration value) / FNC setting mode	<input type="checkbox"/> The "CAL setting mode" and "FNC setting mode" are switched when the SELECT knob ⑰ is pressed and held. Refer to the "2.3. CAL Settings" and "2.4. FNC Settings" for the details. <input type="checkbox"/> The way of specifying setting value: A blinking digit shifts when pressing the SELECT knob ⑰. If the knob is pressed when 1st digit blinks, the settings is finished. Value of blinking digit can be changed when turning the SELECT knob ⑰. If voltage of calibration is input, it affects to output. Usual operation is possible even if blinking. <input type="checkbox"/> The unit LED $\mu\epsilon$ turns on while the CAL setting mode. The unit LED $\mu\epsilon$ turns off while the FNC setting mode. <input type="checkbox"/> The calibration value uses an equivalent value against to the input and can store from 1 $\mu\text{m}/\text{m}$ to 9,999 $\mu\text{m}/\text{m}$ , 1 $\mu\text{m}/\text{m}$ step. The calibration value ( $\pm\text{CAL}$ ) is an equivalent voltage of quarter bridge strain gauge circuit which regarding as gauge factor 2.00. (1 mV/V = 2,000 $\mu\text{m}/\text{m}$ ). " $\mu\text{m}/\text{m}$ " is described as " $\mu\epsilon$ " on the panel. <input type="checkbox"/> The FNC setting mode stores parameters of the cable length compensation function (CLC), bridge check function (BRC), automatic range function (ARG) and decimal point (DP) of numeric display ③.
⑱	[Input of calibration value] switch (+CAL, -CAL)	The switch to input the calibration value specified at the SELECT knob ⑰. The calibration value (+CAL) of "positive (tension)" is input when tilting lever to the right side. The calibration value (-CAL) of "negative (compression)" is input when tilting lever to the left side. <b>Please put lever back to the center (OFF position) after use.</b> <b>Caution</b> If the lever isn't the center (OFF position), the voltage of calibration value is mixed to the input signal and reflects to output voltage.
⑲	HPF LED	The HPF LED ⑲ turns on while using the high-pass filter.

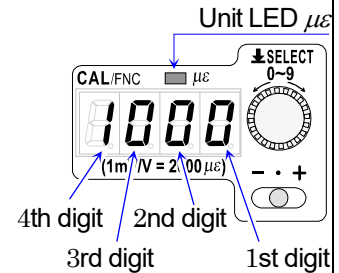

## 2. Names and Functions of Each Parts — 2.1. Names and Functions on the Front Panel

No.	Name	Functions, operations and responses
⑳	Filter knob	
	HPF switch	<ul style="list-style-type: none"> <li>□ The ON/OFF of the high-pass filter (HPF) can be changed when pressing the FILTER knob. The HPF LED ⑲ turns on while HPF is used. The HPF LED ⑲ turns off while HPF isn't used.</li> <li>□ When the HPF is used, DC component of the output can be eliminated, AC signal can be used. <ul style="list-style-type: none"> <li>■ High-pass filter: 2 poles Butterworth type</li> <li>■ Cutoff frequency: 0.5 Hz</li> </ul> </li> </ul>
	LPF knob	<ul style="list-style-type: none"> <li>□ The cutoff frequency of the low-pass filter (LPF) changes when turning the FILTER knob ㉑. The selected cutoff frequency can identify at the LED ㉒.</li> <li>□ Low-pass filter, W/B filter: 4 poles Butterworth type</li> </ul> <p>Cutoff frequency of the AS3603, AS3803: 10, 30, 100, 300, 500 Hz, W/B (2 kHz)</p> <p>Cutoff frequency of the AS3503, AS3903: 10, 30, 100, 500 Hz, 3 kHz, W/B (5 kHz)</p> <p>Cutoff frequency of the AS3703: 10, 30, 100, 500 Hz, 3 kHz, W/B (10 kHz)</p>
	Display digit change switch	The last digit of the numerical display ㉓ shows or hides when the FILTER knob ㉑ is pressed and held.
㉒	LPF LED	The LED of the selected cutoff frequency turns on. The W/B LED turns on when the W/B (Wide Band) is used.

## 2.2. Names and Functions on the Rear Panel

Table 6 2.2. Rear panel

No.	Name	Functions, operations and responses
1	[OSC] switch (Synchronous selection switch)	<p>The switch to select the built-in power source for the bridge circuit.</p> <p>INT: This amplifier is specified as master unit and supplies OSC synchronization signal to other slave units. Concerning of all slave units (that include units turned off) that are used at the same time, set the OSC switch to EXT side.</p> <p>EXT: This amplifier is specified as slave unit and receives synchronization signal. OSC circuit in this amplifier doesn't use.</p> <p><b>Caution</b> Set the OSC switch to INT side when the amplifier is used in standalone.</p> <p>□ The amplifier receives synchronization signal and power from the connector in the storage case when using the case. Concerning of all slave amplifiers (that include units turned off) except master amplifier, set the OSC switch to EXT side. Refer to the "<a href="#">(A) Synchronization between amplifiers</a>" of the "<a href="#">3.6. How to Use the Storage Case</a>" for the details.</p>
2	[BV] switch	<p>Select a bridge power supply voltage (BV) either 0.5 V or 2 V.</p> <p>The selected voltage is indicated at the bridge power supply LED ⑭.</p>
3	OUTPUT 1 connector	<p>The rated output voltage and current are <math>\pm 10</math> V and <math>\pm 5</math> mA (Load of 2 k<math>\Omega</math> or more).</p> <p>The output voltage is indicated at the level indicator ②.</p> <p>Example: The recorder (thermal dot recorder, data acquisition device, etc.) of voltage input, A/D converter can connect.</p>
4	Protective grounding terminal	<p>Ground the amplifier with an earth wire when power cable has not a grounding terminal.</p>
5	Power supply socket	<p>The AC power socket to able to connect type B plug.</p> <p>Accessory power supply cable is type B plug for AC100 V system (AC100 to 120 V).</p> <p><b>Note</b> Please confirm that your local voltage and receptacle type.</p> <p>Select a voltage at the [AC power supply <b>voltage selector</b>] switch before connecting the power cable.</p>
6	INPUT connector	<p>The plug of the bridge box and transducer can be connected.</p> <p>The connector is an input connector of strain measurement instrument that complies with standard (NDIS4102) of The Japanese Society for Non-Destructive Inspection.</p>
7	E-SW [E terminal selector] switch	<p>The selection switch that connects the shield wire (E terminal) of the input cable to either the input common (COM) or the grounding terminal via protective parts (GND). Refer to the "<a href="#">3.1.3. The Switching Function of E terminal</a>" for the details.</p>
8	OUTPUT 2 connector	<p>The rated output voltage and current are <math>\pm 10</math> V and <math>\pm 10</math> mA (Load of 1 k<math>\Omega</math> or more).</p> <p>The output voltage is indicated at the numeric display ③ and can be changed between <math>\pm 10</math> V and approximate <math>\pm 1</math> V using the OUTPUT 2 adjustment volume ⑨. It can arrange scaling of output voltage.</p>

## 2. Names and Functions of Each Parts — 2.2. Names and Functions on the Rear Panel

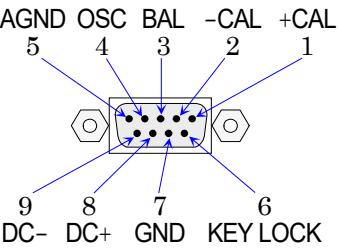
No.	Name	Functions, operations and responses																								
9	I/F interface connector	<p>The electrical interface connector between this amplifier and storage case.</p> <table border="1" data-bbox="502 241 1082 739"> <thead> <tr> <th data-bbox="502 241 794 280">Function</th> <th colspan="2" data-bbox="794 241 1082 280">Terminal pair</th> </tr> </thead> <tbody> <tr> <td data-bbox="502 280 794 347">Input of calibration value (+CAL)</td> <td data-bbox="794 280 938 347">+CAL 1 pin</td> <td data-bbox="938 280 1082 347">GND 7 pin</td> </tr> <tr> <td data-bbox="502 347 794 414">Input of calibration value (-CAL)</td> <td data-bbox="794 347 938 414">-CAL 2 pin</td> <td data-bbox="938 347 1082 414">GND 7 pin</td> </tr> <tr> <td data-bbox="502 414 794 481">Execution of the BAL function</td> <td data-bbox="794 414 938 481">BAL 3 pin</td> <td data-bbox="938 414 1082 481">GND 7 pin</td> </tr> <tr> <td data-bbox="502 481 794 548">Synchronization signal (OSC)</td> <td data-bbox="794 481 938 548">OSC 4 pin</td> <td data-bbox="938 481 1082 548">AGND 5 pin</td> </tr> <tr> <td data-bbox="502 548 794 616">GND</td> <td data-bbox="794 548 938 616">GND 7 pin</td> <td data-bbox="938 548 1082 616">-</td> </tr> <tr> <td data-bbox="502 616 794 683">KEY LOCK</td> <td data-bbox="794 616 938 683">KEY LOCK 6 pin</td> <td data-bbox="938 616 1082 683">GND 7 pin</td> </tr> <tr> <td data-bbox="502 683 794 739">DC power supply</td> <td data-bbox="794 683 938 739">DC+ 8 pin</td> <td data-bbox="938 683 1082 739">DC- 9 pin</td> </tr> </tbody> </table> <p data-bbox="1093 250 1433 537">Pin layout from rear view  </p> <ul data-bbox="502 757 1441 1272" style="list-style-type: none"> <li>□ Supply DC power between 8 and 9 pin.</li> <li>□ The synchronization signal (OSC) can input and output using 4 and 5 pin.</li> <li>□ When 1 and 7 pin are connected (contact input), the input of calibration value (+CAL) is executed.</li> <li>□ When 2 and 7 pin are connected (contact input), the input of calibration value (-CAL) is executed.</li> <li>□ When 6 and 7 pin are connected (contact input), the KEY LOCK is executed.</li> <li>□ When 3 and 7 pin are connected (contact input), the BAL function [of the bridge check function (BRC), cable length compensation function (CLC), automatic range function (ARG) and automatic balance (resistance balance)] is executed. As a condition, set the RANGE to "OFF" before executing the automatic range function (ARG).</li> </ul> <p data-bbox="502 1310 1117 1344"><b>Procedure to execute the BAL function</b></p> <ol data-bbox="502 1355 1441 1825" style="list-style-type: none"> <li>In advance, store parameters of the FNC settings at the same time: ON/OFF (ON: voltage selection) of the automatic range function (ARG), ON/OFF of the bridge check function (BRC), ON/OFF of the cable length compensation function (CLC).</li> <li>When the RANGE is set to "OFF" using remote operation from this interface connector, connect 1, 2 and 7 pin at the same time. The "OFF" of the RANGE LED (16) lights.</li> <li>Disconnect wires of 1, 2 and 7 pin.</li> <li>Shorten wires of 3 and 7 pin to execute the BAL function. Refer to the "(D) Procedure to use the automatic range (ARG) from remote box" of the "3.6. How to Use the Storage Case" for the details.</li> </ol> <p data-bbox="502 1836 1441 1904">MEMO Two I/F interface connectors of the storage case don't equip 8 and 9 pin for DC power supply. Other pins are the same layout.</p>	Function	Terminal pair		Input of calibration value (+CAL)	+CAL 1 pin	GND 7 pin	Input of calibration value (-CAL)	-CAL 2 pin	GND 7 pin	Execution of the BAL function	BAL 3 pin	GND 7 pin	Synchronization signal (OSC)	OSC 4 pin	AGND 5 pin	GND	GND 7 pin	-	KEY LOCK	KEY LOCK 6 pin	GND 7 pin	DC power supply	DC+ 8 pin	DC- 9 pin
Function	Terminal pair																									
Input of calibration value (+CAL)	+CAL 1 pin	GND 7 pin																								
Input of calibration value (-CAL)	-CAL 2 pin	GND 7 pin																								
Execution of the BAL function	BAL 3 pin	GND 7 pin																								
Synchronization signal (OSC)	OSC 4 pin	AGND 5 pin																								
GND	GND 7 pin	-																								
KEY LOCK	KEY LOCK 6 pin	GND 7 pin																								
DC power supply	DC+ 8 pin	DC- 9 pin																								
10 Bottom	[AC power supply voltage selector] switch	<p>The switch to select a power supply voltage at the bottom of the amplifier that is either AC100 V system (AC100 to 120 V) or AC200 V system (AC200 to 240 V). Refer to the "7.2. Changing AC Voltage of Power Supply" for the voltage selection.</p>																								

## 2.3. CAL Settings (The setting of calibration value)

- The calibration value of the CAL settings is an equivalent value against to the input.  
It can be store from 1  $\mu\text{m}/\text{m}$  to 9,999  $\mu\text{m}/\text{m}$ , 1  $\mu\text{m}/\text{m}$  step. " $\mu\text{m}/\text{m}$ " is described as " $\mu\epsilon$ " on the panel.  
It is an equivalent voltage of quarter bridge strain gauge circuit which regarding as gauge factor 2.00.  
(1 mV/V = 2,000  $\mu\text{m}/\text{m}$ )  
Specify the value of each digit for the calibration value.

Input range of  $\mu\epsilon$  in the CAL settings mode

Input range of the calibration value	0000 to 9,999
Input range of 4th digit, 3rd digit, 2nd digit, 1st digit	0 to 9

Example:

Change the calibration value from 2,000  $\mu\text{m}/\text{m}$  to 5,000  $\mu\text{m}/\text{m}$ .

### Procedure

**1. Start the CAL settings mode.**

Press the SELECT knob ⑰ so that 4th digit blinks.  
The unit LED  $\mu\epsilon$  turns on while the CAL setting mode.

**Cautions** When the SELECT knob ⑰ is pressed and held, the "CAL settings mode" and "FNC settings mode" are switched alternately.

**2. Specify value of 4th digit of calibration value.**

Value of blinking digit changes when turning the SELECT knob ⑰.

**3. Specify value from 3rd digit to 1st digit.**

Blinking digit moves when pressing the SELECT knob ⑰.  
Value of blinking digit changes when turning the SELECT knob ⑰.

**4. Finish the CAL settings mode.**

When the SELECT knob ⑰ is pressed while 1st digit blinks, the calibration value is stored, all segments light and the CAL settings mode finishes.

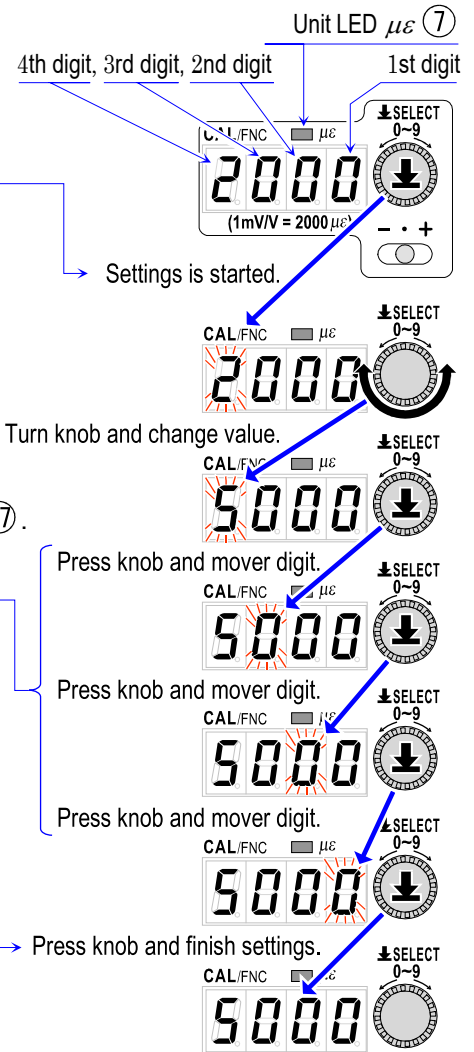

Drawing 4 Calibration value of the CAL settings

### MEMO

- The change of the RANGE, input of the calibration voltage and execution of the BAL function can execute even if blinking digit.
- The changing the value of blinking digit in the CAL settings mode is immediately reflected to output of the calibration voltage.

## 2.4. FNC Settings

- The FNC settings mode stores the following parameters.

Table 7 FNC settings list

4th digit		3rd digit		2nd digit		1st digit	
Cable length compensation function (CLC)		Bridge check function (BRC)		Automatic range function (ARG)		Position of decimal point (DP) in the numerical display ③	
Display	Setting	Display	Setting	Display	Setting	Display	Setting
0	OFF	0	OFF	0	OFF	0	10000
/	ON	/	ON	5	5 V	/	1000.0
				8	8 V	2	100.00
				/	10 V	3	10.000

gray box means factory settings.

ARG : Auto Range

BRC : Bridge Check

CLC : Cable Length Compensation

DP : Decimal Point

- The unit LED  $\mu\varepsilon$  turns off while the FNC setting mode.

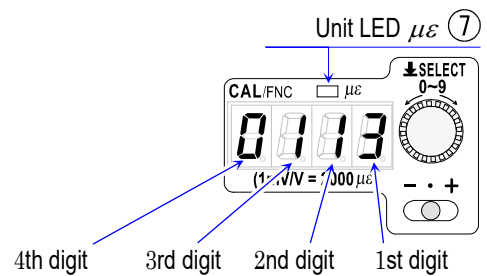

Drawing 5 Indication of the FNC settings

### Procedure

1. **Start the FNC settings mode.**

Press the SELECT knob ⑰ so that 4th digit blinks.

The unit LED  $\mu\varepsilon$  turns off while the FNC setting mode.

**Cautions** When the SELECT knob ⑰ is pressed and held, the "CAL settings mode" and "FNC settings mode" are switched alternately.

2. **Select a digit of the function.**

Blinking digit moves when pressing the SELECT knob ⑰.

3. **Select a parameter of the function.**

Value of blinking digit changes when turning the SELECT knob ⑰.

4. **Finish the FNC settings mode.**

When the SELECT knob ⑰ is pressed while 1st digit blinks, the parameters of the FNC settings are stored, all segments light and the FNC settings mode finishes.

### MEMO

- The position of decimal point can monitor during the DP setting on the numerical display ③.

## 2.5. The BAL Function, Indications in Processing

- When the BAL knob (4) is pressed, the BAL function [that is applied with the bridge check function (BRC), cable length compensation function (CLC) and automatic range function (ARG) and automatic balance (resistance balance) in order] is executed. The sequence of the BAL function is according to the "Drawing 6 Procedures and indications of the BAL function".

**Caution** In order to execute the automatic range (ARG), in advance, set ARG to ON (select of the output voltage) and RANGE to OFF.

ARG : Auto Range  
 BRC : Bridge Check  
 CLC : Cable Length Compensation  
 DP : Decimal Point

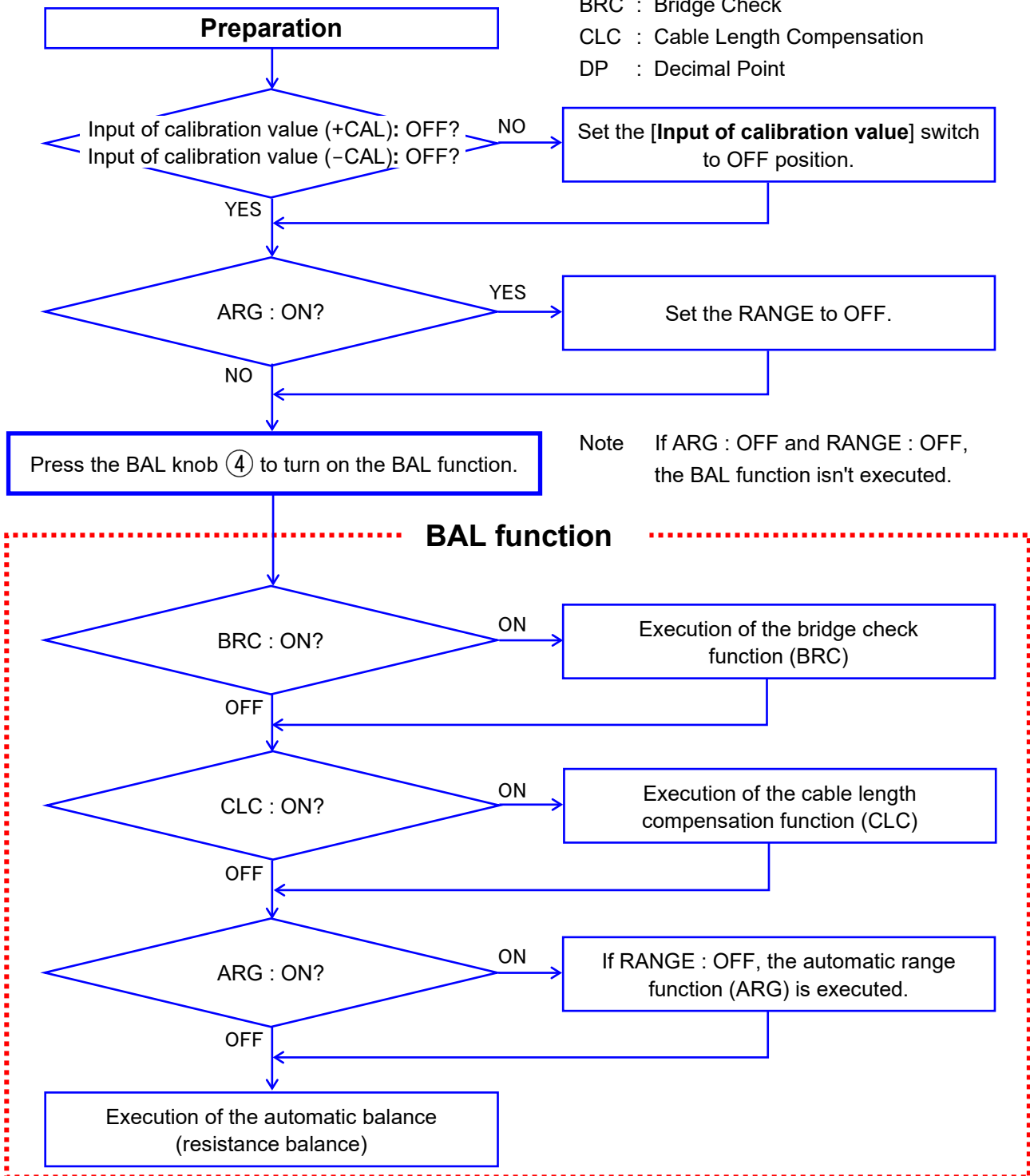

**Drawing 6 Procedures and indications of the BAL function**

### 2.5.1. The Bridge Check Function (BRC), Indications in Processing

- When each arm of the bridge circuit is inspected and the result is the normal state, `Good` is displayed in the numeric display ③ and BRC finishes.  
When disconnection or short circuit is found, `Errr-` is displayed repeatedly in the numeric display ③ and BRC finishes. Repair it according to the message.
- Press and hold the BAL knob ④ or turn off the amplifier when stopping error message that is repeated.
- Press and hold the BAL knob ④ for 1 second or more after confirming the bridge circuit and replacing sensor. Then re-inspection is executed.
- Refer to the "3.4. The Bridge Check Function (BRC)" for the details.

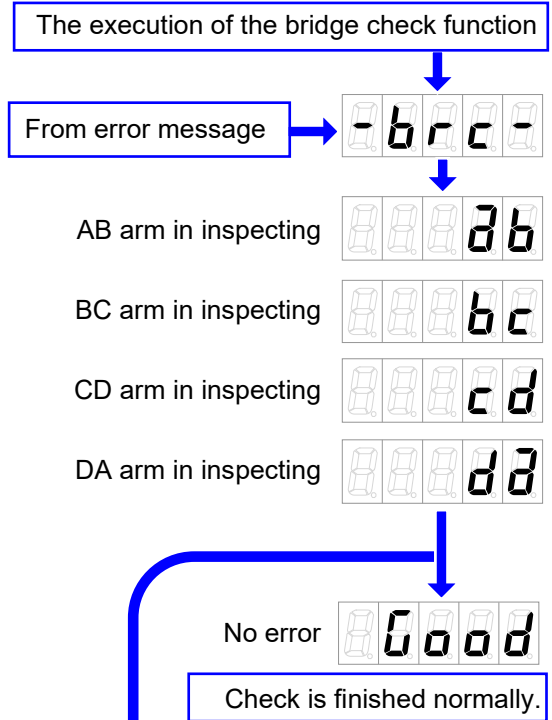

**Example of error message**  
 Example: AB and BC arm of bridge circuit are disconnected or line A is disconnected.

Disconnection or short circuit are found. `Errr-`

AB arm of bridge circuit is disconnected. `E-ab`

BC arm of bridge circuit is disconnected. `E-bc`

or `or`

Line A is disconnected. `E-la`

Error message is repeated.

Press and hold the BAL knob after confirming and repairing them.

The bridge check function is executed again.

**Drawing 7** Indications of the bridge check function (BRC)



### 2.5.2. The Cable Length Compensation Function (CLC), Indications in Processing

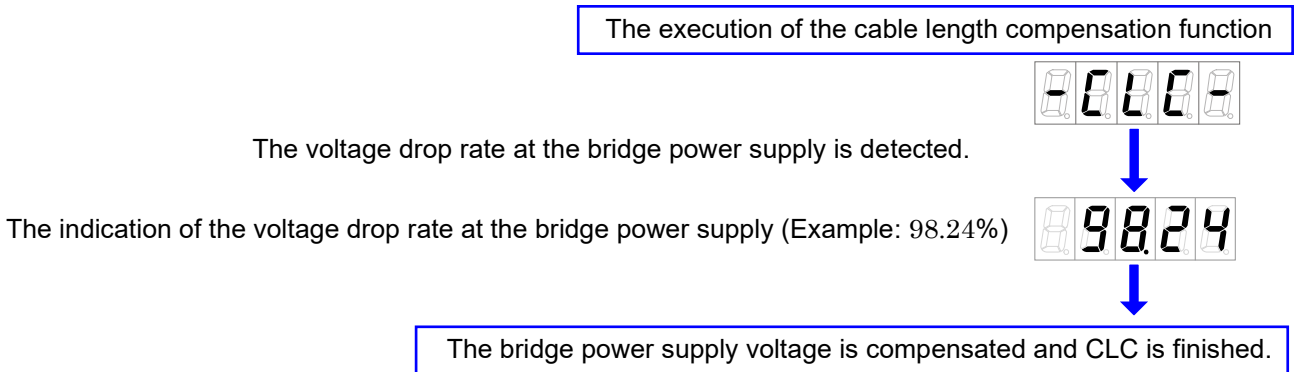

**Drawing 8** Indications in processing of the cable length compensation function (CLC)

**Caution** The way of resetting the cable length compensation function (CLC):  
 Set the cable length compensation function (CLC) to "OFF" in the FNC settings  
 and press the BAL knob ④.

### 2.5.3. The Automatic Range Function (ARG), Indications in Processing

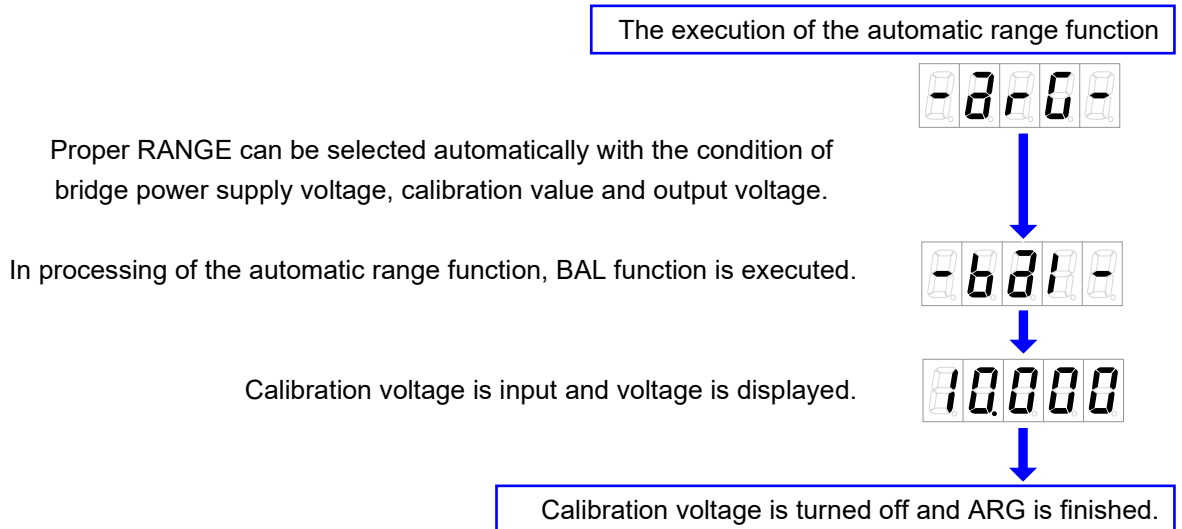

**Drawing 9** Indications in processing of the automatic range function (ARG)

**Caution** When the BAL function is executed, if the [Input of calibration value] switch is +CAL or -CAL and the automatic range function (ARG) is executed, it finishes in the condition that calibration voltage is added.

When the BAL function is executed, if the [Input of calibration value] switch is +CAL or -CAL and the automatic range function (ARG) isn't executed, the output is balanced with including calibration voltage by the BAL function and becomes zero.

## 3. Measurement Preparation

### 3.1. Connecting Cables

#### 3.1.1. Connecting the Input Cable

##### Procedure

1. Paste the strain gauge at measurement point.
2. Connect the strain gauge to bridge box.
3. Connect the cable connected to bridge box and transducer to the input connector [6] on the rear panel. Refer to the "4.1. Precautions before Measurement" for cautions.
4. Voltage drop between the amplifier and bridge box can compensate automatically using the cable length compensation function (CLC). Refer to the "3.5. Cable Length Compensation Function (CLC)". If it measures large strain or it needs to minimize input voltage, set the [BV] switch to 0.5 V on the rear panel.

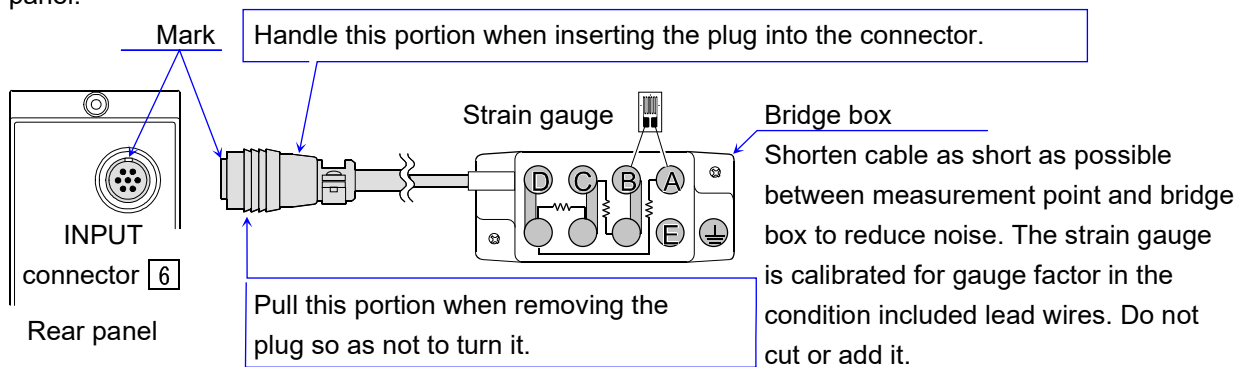

**Drawing 10 Connecting the bridge box**

##### Caution

- The bridge power supply (BV) is outputted between terminal A and C of the INPUT connector [6]. Don't short wires from the INPUT connector [6].
- Don't input voltage and current from an external power source to sensor terminals and bridge circuit of the INPUT connector [6].

#### 3.1.2. Connecting the Power Cable and Output Cables

##### Procedure

1. Connect the power cable adapting to used power supply that are AC100 V system, AC200 V system or DC (12 V or 24 V).
2. Connect the output cable adapting to the recording instrument.
3. Refer to the "4.3. Connection of Output and Load".
4. The frame of the amplifier is connected to output common terminal.

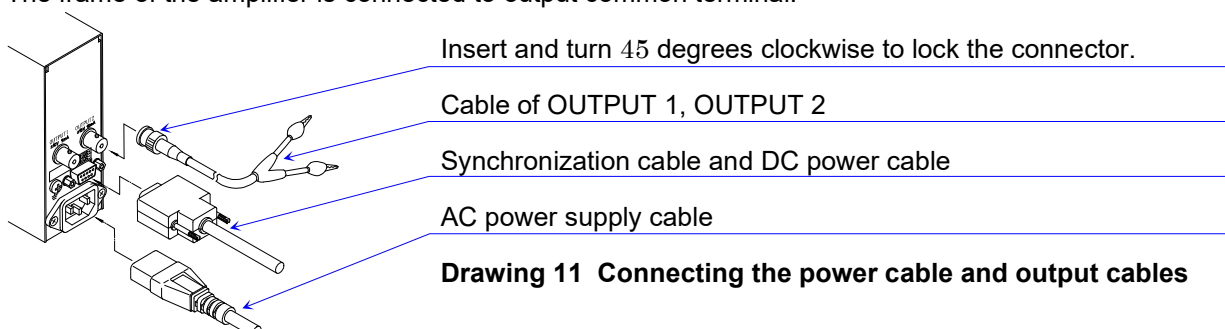

**Drawing 11 Connecting the power cable and output cables**

### 3.1.3. The Switching Function of E terminal (to select connection of shield wire)

- As a shield countermeasure adapting to installation environment of bridge box and strain gauges, connect the E terminal to "GND" or "COM" using the E-SW switch 7 (connected to shield wire of the input cable).
- Connect the E terminal to GND generally. If shield wire of the input cable isn't connected at bridge circuit side, it can switch the connection to COM of the amplifier. Then it can make stability and may improve output noise.

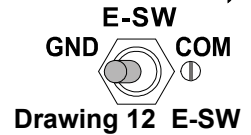

**Caution** Connect to GND if AS3000 is used with conventional AS1603, AS1703 or AS1803R.

#### In case of removing GND terminal (chassis) from shield wire

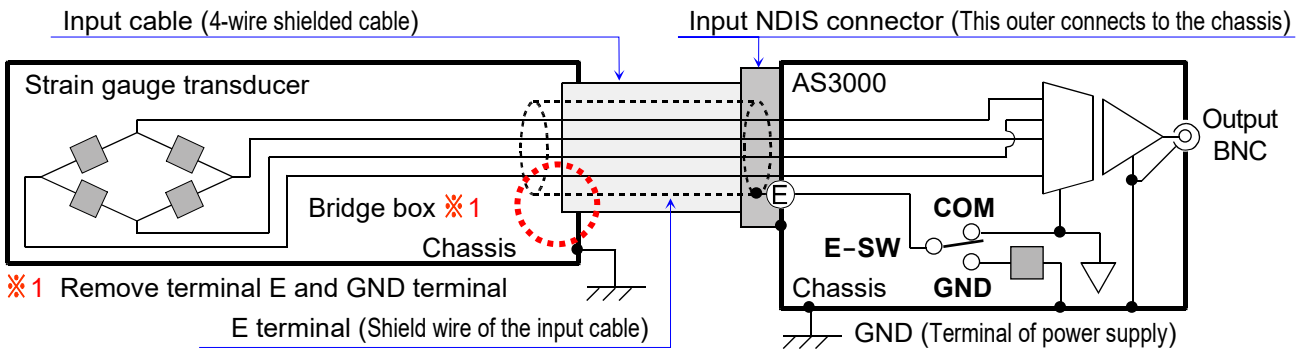

#### In case of connecting GND terminal (chassis) to shield wire

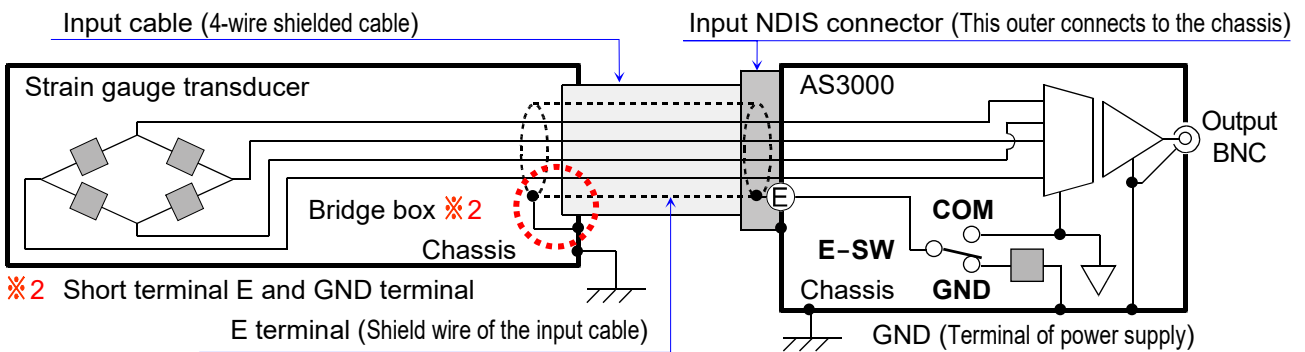

**Caution** When E terminal is connected to GND terminal (chassis), if COM connection is used, performance of voltage tolerance between the input, output and case will become weak.

**Drawing 13** The relationship between the E-SW switch 7 and E terminal

## 3.2. Consideration for Cable Length

The measurable frequency range (frequency characteristics) of the strain amplifier depends on frequency of the bridge power supply supplied for the bridge circuit.

The AS3603 and AS3803 use the bridge power supply of 5 kHz sine wave, can measure phenomenon of DC to 2 kHz.

The AS3503 and AS3903 use the bridge power supply of 12.5 kHz sine wave, can measure phenomenon of DC to 5 kHz.

The AS3703 uses the bridge power supply of 25 kHz sine wave, can measure phenomenon of DC to 10 kHz.

The more the high frequency of the bridge power supply, the more it is increases factor to receive influence of transmission characteristics and capacitance between wires, the cable length is the cause that noise increases due to unnecessary frequency characteristics. Additionally, the more the cable length is long, the more it is hard to get the measurement accuracy. Therefore, it is important to select proper instrument adapting to required measurement frequency.

Especially, when the AS3703 is used, we recommend that the whole length including junction cable and extension cable is within 50 m.

## 3.3. Procedure before Measurement

### 3.3.1. Operation Procedure

#### From turning the power on to preheating the amplifier

1. Set the [Input of calibration value] switch (18) to center position (OFF position).
2. Select power supply voltage at the [AC power supply voltage selector] switch, Connect the power cable and turn on the "POWER" switch (10).
3. Light the "OFF" of the RANGE LED (16) using the RANGE knob (15) (measurement range selection). The switches and pre-settings other than above are not used.

The green LED at the center of the level indicator (2) lights.

Maintain the preheat situation that is turned the amplifier on for 30 minutes.

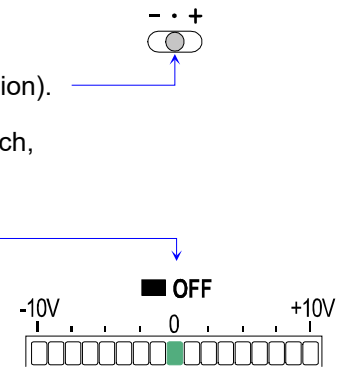

### Procedure of initial balance

4. It is necessary to make initial balance of the bridge circuit so as to perform correct strain measurement. Select measurement range to need measurement using the RANGE knob (15), press the BAL knob (4) in the situation that nothing is apply to the bridge, the amplifier executes the function according to the FNC settings [the bridge check function (BRC), cable length compensation function (CLC) and automatic range function (ARG)] are applied in order, the automatic balance (resistance balance) is executed and adjusts output to zero. Refer to the "2.5. The BAL Function, Indications in Processing" "2.4. FNC Settings" for the details.

### Bridge check function (BRC)

- 4-1. When  $\boxed{Err}$  is displayed in the bridge check function (BRC), repair it according to error message, press and hold the BAL knob (4) again for 1 second or longer and confirm that error doesn't exist. Refer to the "3.4. The Bridge Check Function (BRC)" for error message.

### Cable length compensation function (CLC)

- 4-2. The cable length compensation function (CLC) calculates voltage drop that occurs due to conductor resistance of cable between the amplifier and measurement point (portion of bridge circuit), arranges supply voltage of the bridge circuit so as to compensate voltage drop at the amplifier. Therefore, it is unnecessary to consider fall of sensitivity, precision measurement can perform. Refer to the "[3.5. Cable Length Compensation Function \(CLC\)](#)" for the details.

### Automatic range function (ARG)

- 4-3. Specify calibration value (CAL) and select an adapting output voltage from 5 V, 8 V, 10 V. Set the RANGE knob (15) (measurement range selection) to "OFF".
- 4-4. The measurement range (of the RANGE knob (15) and FINE knob (6)) is adjusted automatically using the automatic range function (ARG) when pressing the BAL knob (4). When the specified calibration value is input, the selected output voltage is output.

### Automatic balance (resistance balance)

- 4-5. Confirm that the green LED at the center of the level indicator (2) lights after executing the automatic balance (resistance balance). When a fine adjustment of the output needs, turn the BAL knob (4) clockwise or counterclockwise and a fine adjustment of zero balance can be executed. The output can change within approximate  $\pm 1$  V. When a fine adjustment of measurement range needs, turn the FINE knob (6).

### Manual adjustment of measurement Range

5. When the measurement range is adjusted manually, use an predicted strain value, rating value of transducer and calibration value of +CAL (or -CAL). Refer to the "[2.3. CAL Settings](#)" for the details. Adjust the RANGE knob (15) and FINE knob (6) so as to become the required output voltage when tilting the [Input of calibration value] switch to +CAL side (-CAL side) and while monitoring output value using the numeric display (3). The FINE knob (6) can set the measurement range with x1 to x2 or x2.5 because of adjusting in small step between ranges. Additionally, because the FINE knob (6) and measurement range selection are interlocked, when keeping to turn the FINE knob (6) and exceeding the range, the range and the RANGE LED (16) is changed automatically.

### The settings of low pass filter

6. Specify a cutoff frequency of the low-pass filter (LPF) with referring frequency of predicted signal using the FILTER knob (20) in measuring. It can reduce higher frequency signal (unnecessary noise etc.) than specified frequency.

### From measurement start to confirmation of measurement value

7. Input the calibration value of the +CAL (or -CAL) before measuring the target signal, read the voltage amplitude of the calibration value and measure the target signal value. Input the +CAL (or -CAL) after target measurement and confirm the amplitude that doesn't change. Inspect the target value by comparing amplitudes of the calibration value and target value.

### 3.3.2. Measurement Range

The measurement range of the amplifier are as follows:

BV: Power supply voltage of bridge circuit

Table 8 Measurement range of AS3603, AS3803

RANGE LED ⑩ Range ( $\mu\varepsilon \times \frac{2}{BV}$ )	FINE knob ⑥ Fine adjustment	Range $\mu\text{m/m}$ ( $\pm 10$ V full scale)	
		BV = 0.5 V	BV = 2 V
200	x1 to x2.5 continuous variable	$\pm 800$ to $\pm 2,000$	$\pm 200$ to $\pm 500$
500	x1 to x2 continuous variable	$\pm 2,000$ to $\pm 4,000$	$\pm 500$ to $\pm 1,000$
1 k	x1 to x2 continuous variable	$\pm 4,000$ to $\pm 8,000$	$\pm 1,000$ to $\pm 2,000$
2 k	x1 to x2.5 continuous variable	$\pm 8,000$ to $\pm 20,000$	$\pm 2,000$ to $\pm 5,000$
5 k	x1 to x2 continuous variable	$\pm 20,000$ to $\pm 40,000$	$\pm 5,000$ to $\pm 10,000$
10 k	x1 to x2 continuous variable	$\pm 40,000$ to $\pm 80,000$	$\pm 10,000$ to $\pm 20,000$
20 k	x1 to x2.5 continuous variable	$\pm 80,000$ to $\pm 200,000$	$\pm 20,000$ to $\pm 50,000$

Table 9 Measurement range of AS3503, AS3703, AS3903

RANGE LED ⑩ Range ( $\mu\varepsilon \times \frac{2}{BV}$ )	FINE knob ⑥ Fine adjustment	Range $\mu\text{m/m}$ ( $\pm 10$ V full scale)	
		BV = 0.5 V	BV = 2 V
500	x1 to x2 continuous variable	$\pm 2,000$ to $\pm 4,000$	$\pm 500$ to $\pm 1,000$
1 k	x1 to x2 continuous variable	$\pm 4,000$ to $\pm 8,000$	$\pm 1,000$ to $\pm 2,000$
2 k	x1 to x2.5 continuous variable	$\pm 8,000$ to $\pm 20,000$	$\pm 2,000$ to $\pm 5,000$
5 k	x1 to x2 continuous variable	$\pm 20,000$ to $\pm 40,000$	$\pm 5,000$ to $\pm 10,000$
10 k	x1 to x2 continuous variable	$\pm 40,000$ to $\pm 80,000$	$\pm 10,000$ to $\pm 20,000$
20 k	x1 to x2.5 continuous variable	$\pm 80,000$ to $\pm 200,000$	$\pm 20,000$ to $\pm 50,000$
50 k	x1 to x2.5 continuous variable	$\pm 200,000$ to $\pm 500,000$	$\pm 50,000$ to $\pm 125,000$

- " $\mu\text{m/m}$ " is described as " $\mu\varepsilon$ " on the panel.

## 3.4. The Bridge Check Function (BRC)

### 3.4.1. Overview

- The bridge check function (BRC) can detect disconnection and short circuit of the bridge circuit, can detect disconnection of the cable, can use for troubleshooting and shortening of measurement time because the disconnection can be easily found.
- Specify the bridge check function (BRC) in the FNC settings mode. Refer to the "2.4. FNC Settings" for the details.
- Resistance value is 120 Ω or more.

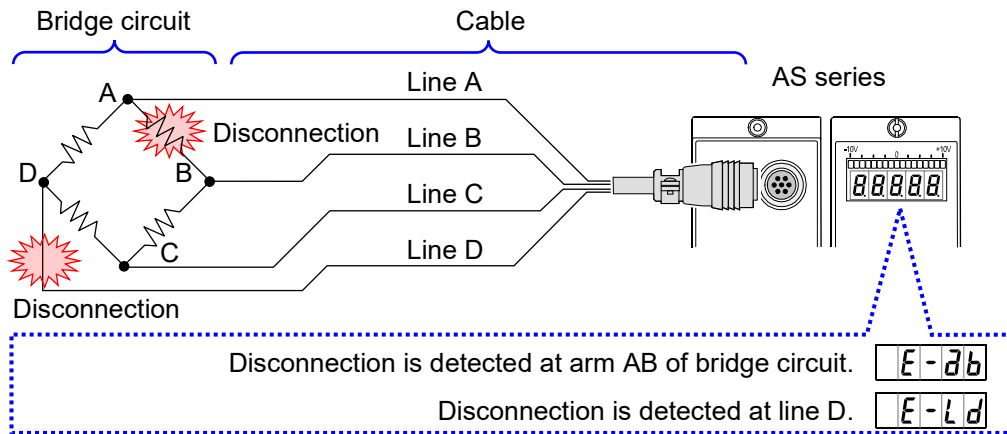

**Drawing 14 Overview of the bridge check function (BRC)**

### The result of bridge check function

- When the bridge check function (BRC) doesn't detect an error, `U000` is displayed in the numeric display ③.
- When the bridge check function (BRC) detects error, `E r r -` and error position are displayed repeatedly in the numeric display ③. Press and hold the BAL knob ④ or turn off the amplifier if you want to stop error message repeated in the numeric display ③.

### Repair and dealing with error

Refer to the "3.4.2. Error Indication List of Disconnection and Short Circuit" for error messages.

Repair them according to error messages. Press and hold the BAL knob ④ 1 second or more after the repair, inspect again using the bridge check function (BRC). When error clears, `U000` is displayed in the numeric display ③.

**Caution** When disconnection or short circuit occurs, error message is displayed always. On the other hand, error position may not be identified due to number of disconnections and combination of disconnections (at portion of cable and bridge circuit). Refer to the "2.4. FNC Settings" if turning off the bridge check function (BRC).

Table 10 Example of error indication

<code>E-2b</code>	E : Disconnection – Arm AB	Disconnection occurs at arm AB of bridge circuit.
<code>E-Ld</code>	E : Disconnection – line A	Disconnection occurs at line A.
<code>S-2b</code>	S : Short circuit – Arm AB	Short circuit occurs at arm AB of bridge circuit.
<code>OPEN</code>	Open circuit	Bridge circuit isn't connected.

### 3.4.2. Error Indication List of Disconnection and Short Circuit

#### Error indications of disconnection

○ : The normal state, ✕ : Disconnection

Table 11 Error indications of disconnection

Disconnection at arm				Disconnection at line				Numeric display ③
A-B	B-C	C-D	D-A	A	B	C	D	
○	○	○	○	○	○	○	○	Good
✕	○	○	○	○	○	○	○	E-ab
○	✕	○	○	○	○	○	○	E-bc
○	○	✕	○	○	○	○	○	E-cd
○	○	○	✕	○	○	○	○	E-da
✕	✕	○	○	○	○	○	○	E-ab E-bc or E-Lb
○	○	○	○	○	✕	○	○	E-bc E-cd or E-Lc
○	✕	✕	○	○	○	○	○	
○	○	○	○	○	○	✕	○	
○	○	✕	✕	○	○	○	○	E-cd E-da or E-Ld
○	○	○	○	○	○	○	✕	
✕	○	○	✕	○	○	○	○	E-da E-ab or E-Ld
○	○	○	○	✕	○	○	○	
○	✕	○	✕	○	○	○	○	E-bc E-da
✕	○	✕	○	○	○	○	○	E-ab E-cd
✕	✕	✕	○	○	○	○	○	E-ab E-bc E-cd or E-Lb E-Lc
○	○	○	○	○	✕	✕	○	E-ab E-bc E-da or E-Ld E-Lb
✕	✕	○	✕	○	○	○	○	
○	○	○	○	✕	✕	○	○	E-ab E-cd E-da or E-Ld E-Ld
✕	○	✕	✕	○	○	○	○	
○	○	○	○	✕	○	○	✕	E-bc E-cd E-da or E-Lc E-Ld
○	✕	✕	✕	○	○	○	○	
○	○	○	○	○	○	✕	✕	OPEN
○	○	○	○	○	✕	○	✕	
○	○	○	○	✕	✕	✕	○	
○	○	○	○	✕	✕	○	✕	
○	○	○	○	✕	○	✕	✕	
○	○	○	○	○	✕	✕	✕	
○	○	○	○	○	✕	✕	✕	
✕	✕	✕	✕	○	○	○	○	



### Error indications of short circuit

○ : The normal state, ✕ : Disconnection

Table 12 Error indications of short circuit

Short circuit at arm				Short circuit at of line				Numeric display ③
A-B	B-C	C-D	D-A	A	B	C	D	
○	○	○	○	○	○	○	○	Good
✕	○	○	○	○	○	○	○	S-d̄b
○	✕	○	○	○	○	○	○	S-bc
○	○	✕	○	○	○	○	○	S-cd
○	○	○	✕	○	○	○	○	S-d̄d
✕	✕	○	○	○	○	○	○	S-d̄b S-bc
○	✕	✕	○	○	○	○	○	S-bc S-cd
○	○	✕	✕	○	○	○	○	S-cd S-d̄d
✕	○	○	✕	○	○	○	○	S-d̄b S-d̄d
✕	○	✕	○	○	○	○	○	S-d̄b S-cd
○	✕	○	✕	○	○	○	○	S-bc S-d̄d
✕	✕	✕	○	○	○	○	○	S-d̄b S-bc S-cd S-d̄d
✕	✕	○	✕	○	○	○	○	
✕	○	✕	✕	○	○	○	○	
○	✕	✕	✕	○	○	○	○	
✕	✕	✕	✕	○	○	○	○	

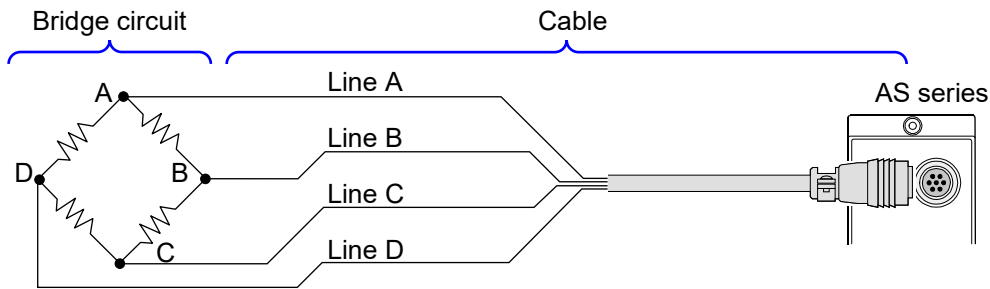

Drawing 15 Bridge circuit and lines

Table 13 Display symbols

Symbol	Portion that error has occurred.	
d̄	Point A in bridge circuit	Line A of cable
b	Point B in bridge circuit	Line B of cable
c	Point C in bridge circuit	Line C of cable
d	Point D in bridge circuit	Line D of cable
l̄	Cable	
ε	Disconnection	
5	Short circuit	

### 3.5. Cable Length Compensation Function (CLC)

- When the cable connecting between the amplifier and bridge box is long, the voltage at the bridge box drops due to conductor resistance of the cable. Refer to the "Table 14 Example of voltage drop rate at bridge circuit" for the example of voltage drop rate.
- The AS series adopts original automatic compensation circuit instead of compensation using remote sensing and numeric settings (of cable length, diameter of cable) at standard 6-wire cable, supplies the bridge power supply voltage (BV) that voltage drop due to conductor resistance of the cable is compensated, provides precision strain measurement.
- The cable length compensation function (CLC) is specified at the FNC settings. Refer to the "2.4. FNC Settings" for the details.
- If you want to cancel the compensation value (no compensation) of voltage drop rate at bridge power supply, set the cable length compensation function (CLC) to "OFF" and press the BAL knob (4).

Table 14 Example of voltage drop rate at bridge circuit

Resistance of bridge circuit	Length (m) between input connector and bridge box.			
	20 m	50 m	100 m	200 m
120 Ω	-1.2 %	-2.9 %	-5.6 %	-10.6 %
350 Ω	-0.4 %	-1.0 %	-2.0 %	-3.9 %
500 Ω	-0.3 %	-0.7 %	-1.4 %	-2.8 %
1,000 Ω	-0.1 %	-0.4 %	-0.7 %	-1.4 %

※ Example calculated with tin-plated annealed copper wire, 0.5 mm<sup>2</sup>, 20 °C, 35.73 Ω/km.

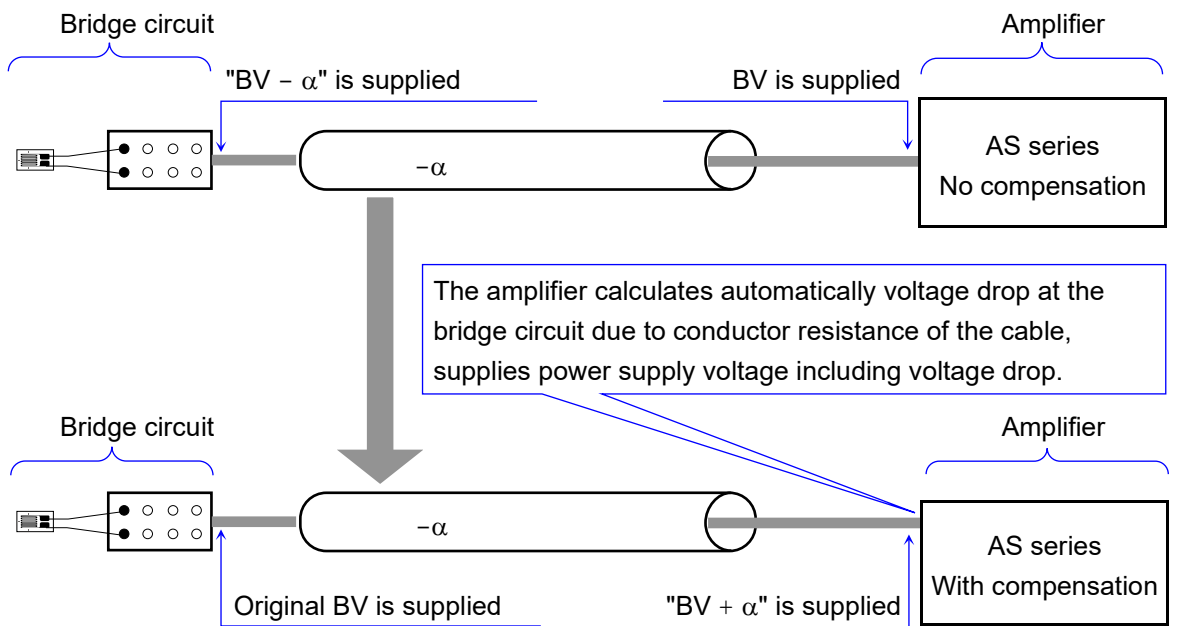

BV: Bridge power supply voltage

Drawing 16 Overview of the cable length compensation function

 **CAUTION**

- The cable length compensation function (CLC) equipped in the amplifier assumes that transducer or bridge box is composed with the Wheatstone bridge circuit. Therefore, the function cannot execute correctly if connecting the calibration device that the Wheatstone bridge circuit isn't used.
- A part of high precision transducers may equip resistance for output adjustment in inside. If it is connected to the amplifier, the output voltage supplied to bridge circuit may increase (maximum 130 %) compared to standard output because the amplifier assumes this resistance as resistance of the cable and compensates output voltage.
- When the cable length compensation function (CLC) is set to ON and the calibration value (+CAL or -CAL) is input, if output is a unexpected large value compared to standard value, switch the cable length compensation function (CLC) to "OFF". Refer to the "2.4. FNC Settings" for the setting procedure.

- Concerning the transducer that can connect the AS3000 series, the following list is whether output adjustment resistance is equipped or not.

Table 15 Existence of built-in output adjustment resistance

Model	Built-in resistance	Model	Built-in resistance	Model	Built-in resistance
9E01-L1	Equipped	9E01-L21	Equipped	9E02-P6	Not equipped
9E01-L2	Not equipped	9E01-L22A	Equipped	9E02-P6G	Not equipped
9E01-L3	Equipped	9E01-L23	Equipped	9E02-P11	Equipped
9E01-L4	Equipped	9E01-L23WA	Equipped	9E02-P13A	Equipped
9E01-L5	Equipped	9E01-L23H	Not equipped	9E08-D1A	Equipped
9E01-L8	Equipped	9E01-L31	Equipped	9E08-D3A	Equipped
9E01-L9	Equipped	9E01-L33	Equipped	9E08-D4	Equipped
9E01-L11A	Equipped	9E01-L35	Equipped	9E08-D6	Not equipped
9E01-L14	Equipped	9E01-L42	Not equipped	9E05-B1	Equipped
9E01-L15A	Equipped	9E01-L43A	Not equipped	9E05-T1	Equipped
9E01-L18	Equipped	9E01-L44A	Not equipped	9E07-A1	Not equipped
9E01-L18WA	Equipped	9E01-P2	Equipped	9E07-A2	Not equipped
9E01-L19	Equipped	9E01-P3	Not equipped	9E07-A3	Not equipped
9E01-L19WA	Equipped	9E01-P4	Equipped	9E07-A4	Not equipped

### 3.6. How to Use the Storage Case

- Refer to the "6.1. Storage Case" for basic connection of the storage case and switch operations.
- Multiple amplifiers installed in the storage case can synchronize frequency of power supply. The input of the calibration value (+CAL or -CAL), KEY LOCK and the BAL function [ of the bridge check function (BRC), cable length compensation function (CLC), automatic range function (ARG) and automatic balance (resistance balance) ] can be execute at once. Additionally, all these storage cases can be executed at once when connecting multiple storage using the I/F interface connector.

#### (A) Synchronization between amplifiers

- When multiple amplifiers are installed in the storage case, the synchronization signal to synchronize mutually them is supplied by wiring inside the storage case.

Set the [Synchronous selection] switch to INT at a master amplifier only.

Set the [Synchronous selection] switch to EXT at other slave amplifiers (including amplifier that is turned off).

- Master amplifier set to INT supplies synchronization signal for bridge power supply of other slave amplifiers set to EXT.
- Settings of these amplifiers have effective.
- If frequencies of bridge power supply are different, these amplifiers cannot install in the same storage case and storage cases of different frequencies cannot mix.

The AS3603 and AS3803 use the bridge power supply of 5 kHz.

The AS3503 and AS3903 use the bridge power supply of 12.5 kHz.

The AS3703 uses the bridge power supply of 25 kHz.



## CAUTION

- Don't set multiple INT at multiple amplifiers. It cannot measure and may cause of malfunctions. Set INT to single amplifier only. Set others (including amplifier that is turned off) to EXT.

Example of rear view of storage case

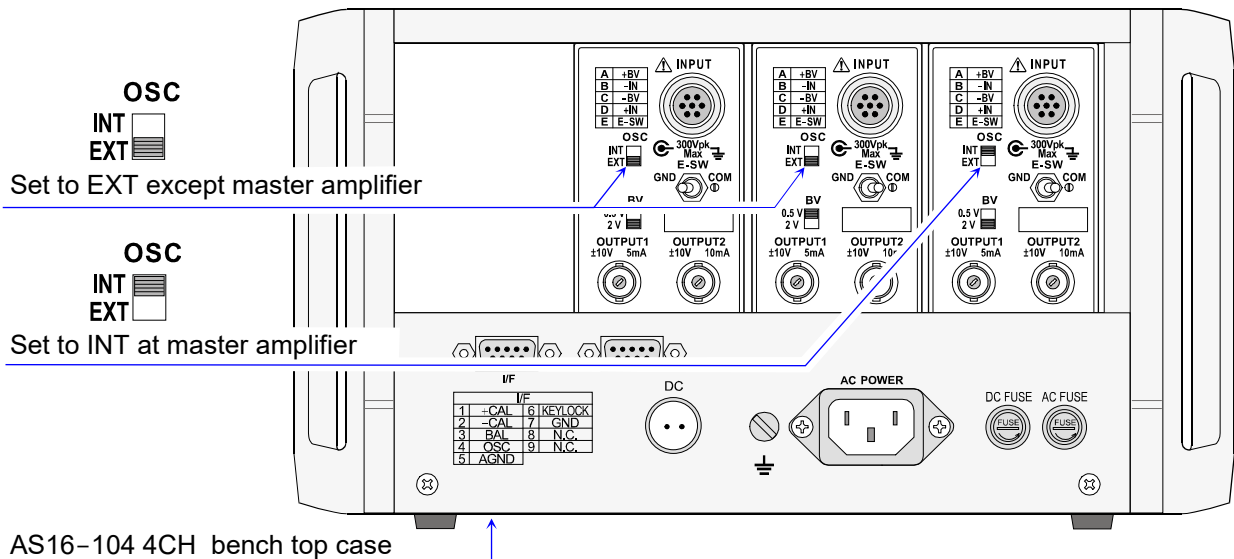

Drawing 17 Synchronization settings

### (B) Synchronization between storage cases

- Synchronize storage cases that are connected when multiple storage cases are used.  
 Connect the synchronization cable to the I/F interface on the rear panel of the storage case as that describes to the "[Drawing 18 Connecting multiple storage cases](#)", synchronize them.  
 Set the [**Synchronous selection**] switch  to INT on the rear panel of the master amplifier that is only one of all amplifiers. Set the [**Synchronous selection**] switch to EXT at other slave amplifiers (including amplifier that is turned off).
- If frequencies of bridge power supply are different, these amplifiers cannot install in the same storage case and storage cases of different frequencies cannot mix.  
 The AS3603 and AS3803 use the bridge power supply of 5 kHz, can synchronize.  
 The AS3503 and AS3903 use the bridge power supply of 12.5 kHz, can synchronize.  
 The AS3703 uses the bridge power supply of 25 kHz.

**⚠ CAUTION**

- Don't set multiple INT at multiple amplifiers. It cannot measure and may cause of malfunctions. Set INT to single amplifier only. Set others (including amplifier that is turned off) to EXT.

Synchronization cable

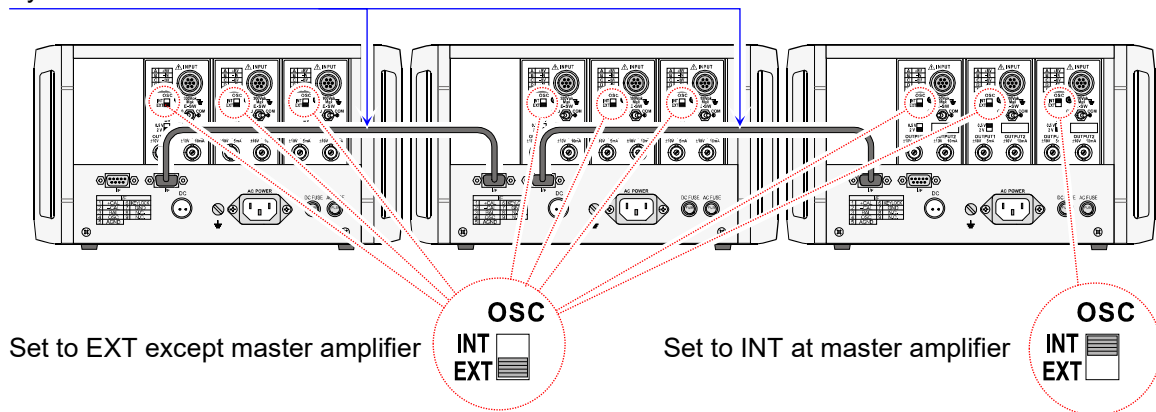

Example of rear view of storage case (AS16-104 4CH bench top case)

**Drawing 18 Connecting multiple storage cases**

### (C) Remote box and I/F interface connector

The remote box to execute remote operation is small box like an illustration that switches are connected. Use momentary switch that can maintain last status because of preventing operation error. When the remote box is connected to the I/F interface connector and is operated, all amplifiers responses.

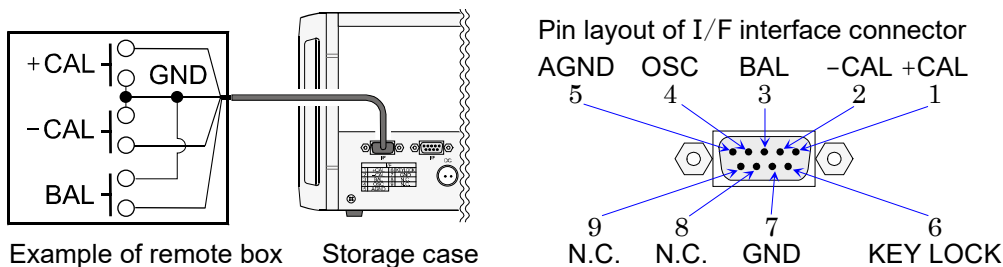

**Drawing 19 Overview of remote box**

## Operation of the I/F interface connector

- Synchronization signal (OSC) can be input and output between 4 and 5 pin.
- When 1 and 7 pin are connected (contact input), the input of the calibration value (+CAL) is executed to all amplifiers.
- When 2 and 7 pin are connected (contact input), the input of the calibration value (-CAL) is executed to all amplifiers.
- When 6 and 7 pin are connected (contact input), the KEY LOCK is executed to all amplifiers.
- When 3 and 7 pin are connected (contact input), the BAL function [of the bridge check function (BRC), cable length compensation function (CLC), automatic range function (ARG) and automatic balance (resistance balance)] is executed against to all amplifiers.

### Procedure to use the automatic range (ARG)

It is necessary to set the RANGE to "OFF" in advance so as to execute the automatic range function (ARG).

1. Set the output voltage of the automatic range function (ARG) in the FNC settings in advance.
2. When the RANGE is set to "OFF" using remote operation from this interface connector, connect 1, 2 and 7 pin at the same time. The "OFF" of the RANGE LED (16) lights.
3. Remove 1 and 2 pin from 7 pin.
4. When 3 and 7 pin are connected (contact input), the BAL function of the automatic range function (ARG) is executed. Refer to the "(D) Procedure to use the automatic range (ARG) from remote box" for the details.

### (D) Procedure to use the automatic range (ARG) from remote box

It is necessary to set the RANGE to "OFF" in advance so as to execute the automatic range function (ARG) against to all channels from the remote box described at the "[Drawing 19 Overview of remote box](#)".

### Procedure

1. Select the output voltage of the automatic range function (ARG) in the FNC settings in advance. Select ON/OFF of the bridge check function (BRC) and cable length compensation function (CLC). Refer to the "[2.4. FNC Settings](#)" for the details.
2. Connect the +CAL terminal (1 pin) and -CAL terminal (2 pin) to the GND terminal (7 pin). The RANGE changes to "OFF" and the "OFF" of the RANGE LED (16) lights.
3. Remove the +CAL terminal and -CAL terminal from the GND terminal.
4. When the BAL terminal (3 pin) and GND terminal (7 pin) are connected, the automatic range function (ARG) is executed against to all channels.

### Caution

- It is necessary to set to "ON" in the FNC settings in advance so as to execute the bridge check function (BRC) and cable length compensation function (CLC) of the BAL function.
- It is necessary to select the output voltage of the automatic range function (ARG) in the FNC settings in advance.

## 4. Measurement System

### 4.1. Precautions before Measurement

The following table describes cautions that should be considered before measurement.

Table 16 Precautions before measurement

Item	Caution	General cause
Installation environment of strain gauge and bridge box		
	Use soldering at connection point. Connect connector firmly.	Connection error, mixed noise, unstable measurement
	Maintain isolation resistance of strain gauge more than 60 MΩ.	Unstable measurement, mixed noise
	Don't install in strong electric and magnetic fields.	Mixed noise
	Avoid place of low humidity and high temperature.	Unstable measurement
	Shorten wire between strain gauge and bridge box as possible as. Use shield cable.	Deterioration of gauge factor and linearity, mixed noise
	Shorten cable between bridge box and amplifier as possible as.	Error occurs between calibration value and bridge circuit signal due to voltage drop at bridge. The cable length compensation function can compensate it.
Installation environment of dynamic strain amplifier		
	Use within operating environment: -10 to 50 °C, 20 to 85 %RH (no condensation).	Unstable measurement
	Suppress vibration within 29.4 m/s <sup>2</sup> . (3,000 rpm, 0.6 mm P-P)	Damage of amplifier, mixed noise
	Don't install in strong electric and magnetic fields.	Mixed noise
	Ground case of the amplifier when using AC power supply surely.	Mixed noise
Operation of dynamic strain amplifier		
	Select appropriate voltage for strain gauge concerning of the input voltage to bridge box.	Measurement error due to heating at strain gauge.
	Connect connector surely.	Unstable measurement, connection error
	Avoid that oil and mad etc. invade into the input connector.	Unstable measurement, connection error
	Confirm power supply voltage. Confirm power supply either the AC100 V system, AC200 V system or DC power supply. Especially, confirm polarities of DC power supply.	Unstable measurement when power supply voltage is low. Heating and damage of parts when power supply voltage is high. No operation when polarities of DC power supply.
	Keep the balance that external force is canceled while executing the automatic range function.	Balance cannot get.
	Fix the RANGE knob (15) and FINE knob (6) during measurement. Use the KEY LOCK.	Amplitude of calibration value changes.
	Understand characteristic of the low-pass filter and use it.	Deterioration of amplitude, occurrence of phase error
	Don't short the output cable.	Heating and damage of circuit Amplifier may not turn on.

4. Measurement System — 4.1. Precautions before Measurement

Item	Caution	General cause
Noise countermeasure		
	<p>The amplifier is isolated between the input (including shield) and output.</p> <ol style="list-style-type: none"> <li>1. Connect lead wire of strain gauge to shield wire and connect shield wire to E terminal of the bridge box.</li> <li>2. When the E-SW switch <input type="checkbox"/> is GND, connect the grounding terminal of the bridge box and shield wire (E terminal) of the input cable, connect the grounding terminal of the bridge box and base metal.</li> <li>3. When the E-SW switch <input type="checkbox"/> is COM, isolate E terminal from base metal. (It shields the bridge circuit using input COM, doesn't ground E terminal.)</li> <li>4. Ground the output common. (Confirm that power cable with grounding terminal is ground.)</li> </ol>	
When step 1. to 4. (2. or 3.) or either step is executed, it may have effective of noise reduction.		



## 4.2. Connection of Input

### 4.2.1. Examples of Bridge Circuit with Strain Gauge

- When strain gauge is built into a arm of the Wheatstone bridge circuit, the combination of strain gauges can describe as "**Quarter bridge circuit using one gauge configuration**", "**Half bridge circuit using two gauges configuration**" and "**Full bridge circuit using four gauges configuration**". On the other hand, by kind of stress that strain gauge receives, it can classify to the "**same sign equivalence value**", "**opposite sign equivalence value**", "**opposite sign constant proportional value**" and etc., can combine them. Additionally, temperature compensation, error elimination and extension of output voltage are possible when using characteristics of the bridge circuit. The followings describe configuration examples of the general bridge circuit using strain gauge. Used symbols are follows:

R : Solid resistance ( $\Omega$ )

K : Gauge factor in use (to assume as 2.00)

R<sub>g</sub> : Resistance of strain gauge ( $\Omega$ )

$\epsilon$  : Strain value  $\mu\text{m}/\text{m}$

R<sub>d</sub> : Resistance of dummy gauge ( $\Omega$ )

E : Input voltage of bridge circuit (V)

r : Resistance of lead wire ( $\Omega$ )

$\nu$  : Poisson's ratio of sample

e : Output voltage from bridge circuit (V) N : Output coefficient of the bridge circuit based on gauge configuration

- Regarding of how to attach a strain gauge, the characteristics of the gauge itself, how to measure with a bridge circuit, refer to "Technical document of strain gauge" of strain gauge manufacture and "Strain gauge test I", "Strain gauge test II", "Strain gauge test III" etc. published by The Japanese Society for Non-Destructive Inspection.
- The bridge box of model 5370A or 5373A are used in the following examples of wiring.

Table 17 The Wheatstone bridge circuits with strain gauge

Gauge configuration / Circuit	Example	Wiring of bridge box	Usage and remarks
<p>One strain gauge configuration</p>			<ul style="list-style-type: none"> <li>Simple tension, compression, simple bending.</li> <li>Temperature change is small.</li> <li>Bridge output coefficient N = 1</li> <li>Actual strain value = Measurement value / N</li> </ul>
<p>One strain gauge 3-wire configuration</p>			<ul style="list-style-type: none"> <li>Simple tension, compression, simple bending.</li> <li>Temperature compensation using lead wire of strain gauge.</li> <li>Bridge output coefficient N = 1</li> <li>Actual strain value = Measurement value / N</li> </ul>
<p>One active and one dummy strain gauges configuration</p>			<ul style="list-style-type: none"> <li>Simple tension, compression, simple bending.</li> <li>Temperature compensation using dummy strain gauge.</li> <li>Bridge output coefficient N = 1</li> <li>Actual strain value = Measurement value / N</li> </ul>

4. Measurement System — 4.2. Connection of Input

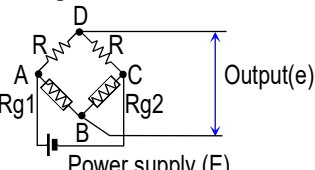
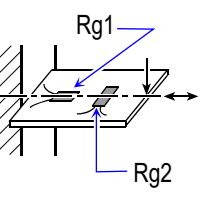
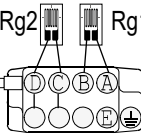
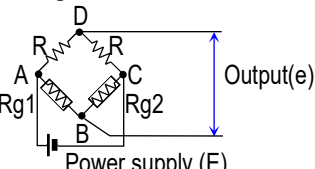
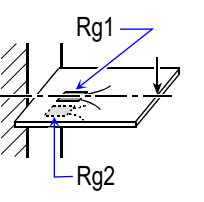
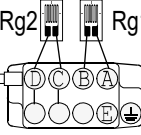
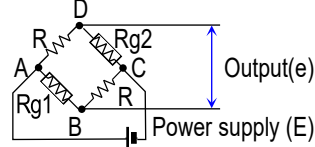
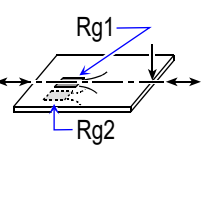
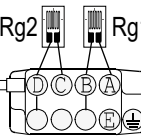
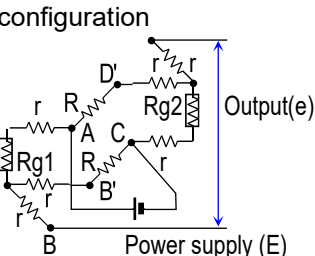
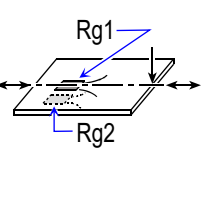
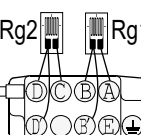
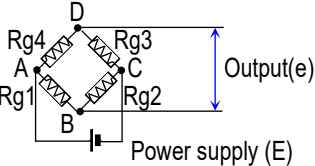
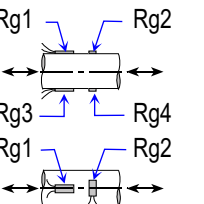
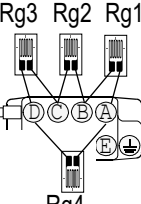
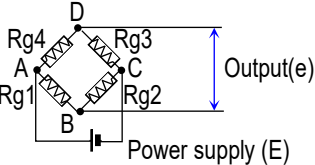
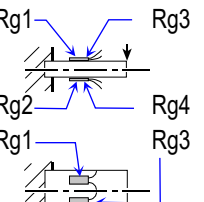
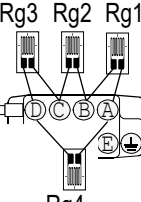
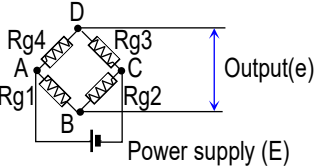
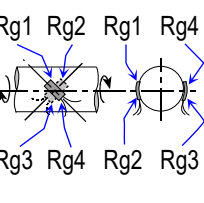
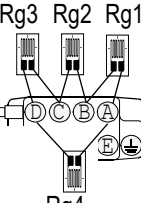
Gauge configuration / Circuit	Example	Wiring of bridge box	Usage and remarks
<p>Two active strain gauges configuration</p> 			<ul style="list-style-type: none"> <li><input type="checkbox"/> Simple tension, compression, simple bending.</li> <li><input type="checkbox"/> Temperature compensation.</li> <li><input type="checkbox"/> Bridge output coefficient <math>N = 1 + \nu</math></li> <li>Actual strain value = Measurement value / N</li> </ul>
<p>Two active strain gauges configuration</p> 			<ul style="list-style-type: none"> <li><input type="checkbox"/> Detection of bending strain.</li> <li><input type="checkbox"/> Canceling tension and compression strain.</li> <li><input type="checkbox"/> Temperature compensation.</li> <li><input type="checkbox"/> Bridge output coefficient <math>N = 2</math></li> <li>Actual strain value = Measurement value / N</li> </ul>
<p>Opposite-arm, two active strain gauges configuration</p> 			<ul style="list-style-type: none"> <li><input type="checkbox"/> Detection of tension and compression strain.</li> <li><input type="checkbox"/> Canceling bending strain.</li> <li><input type="checkbox"/> Influence of temperature change is doubled.</li> <li><input type="checkbox"/> Bridge output coefficient <math>N = 2</math></li> <li>Actual strain value = Measurement value / N</li> </ul>
<p>Opposite-arm, two active 3-wire strain gauges configuration</p> 			<ul style="list-style-type: none"> <li><input type="checkbox"/> Detection of tension and compression strain.</li> <li><input type="checkbox"/> Canceling bending strain.</li> <li><input type="checkbox"/> Influence of temperature change is doubled.</li> <li><input type="checkbox"/> Temperature compensation using lead wire of strain gauge.</li> <li><input type="checkbox"/> Bridge output coefficient <math>N = 2</math></li> <li>Actual strain value = Measurement value / N</li> </ul>
<p>Four active strain gauges configuration</p> 			<ul style="list-style-type: none"> <li><input type="checkbox"/> Detection of tension and compression strain.</li> <li><input type="checkbox"/> Canceling bending strain.</li> <li><input type="checkbox"/> Temperature compensation.</li> <li><input type="checkbox"/> Bridge output coefficient <math>N = 2(1 + \nu)</math></li> <li>Actual strain value = Measurement value / N</li> </ul>
<p>Four active strain gauges configuration</p> 			<ul style="list-style-type: none"> <li><input type="checkbox"/> Detection of bending strain.</li> <li><input type="checkbox"/> Canceling tension and compression strain.</li> <li><input type="checkbox"/> Temperature compensation.</li> <li><input type="checkbox"/> Bridge output coefficient <math>N = 4</math></li> <li>Actual strain value = Measurement value / N</li> </ul>
<p>Four active strain gauges configuration</p> 			<ul style="list-style-type: none"> <li><input type="checkbox"/> Detection of twisting strain.</li> <li><input type="checkbox"/> Canceling tension, compression and bending strain.</li> <li><input type="checkbox"/> Temperature compensation.</li> <li><input type="checkbox"/> Bridge output coefficient <math>N = 4</math></li> <li>Actual strain value = Measurement value / N</li> </ul>

### 4.2.2. Bridge Box

- The composition of the bridge box is terminal box, cable and connector.
- The terminal box is equipped terminals to connect strain gauges and is built-in 3 high performance resistances.  
 Model 5370A : 120 Ω high performance resistance  
 Model 5373A : 350 Ω high performance resistance
- The method to use the terminal box connects strain gauge and short bar, constitutes bridge circuit with them.  
 Short bars used for various strain gauge configuration are included in accessory.

#### Installation procedure

- (A) Put the bridge box at measurement point as nearly as possible.
- (B) Use attachment holes of the "Drawing 20 View of bridge box" when fixing the bridge box.
- (C) Don't install the bridge box in wet location, location of excessive temperature change, strong electric and magnetic fields.
- (D) Arrange the cable so as to fix the position after installing them and connect to the amplifier.

#### Connecting to bridge box (5370A, 5373A)

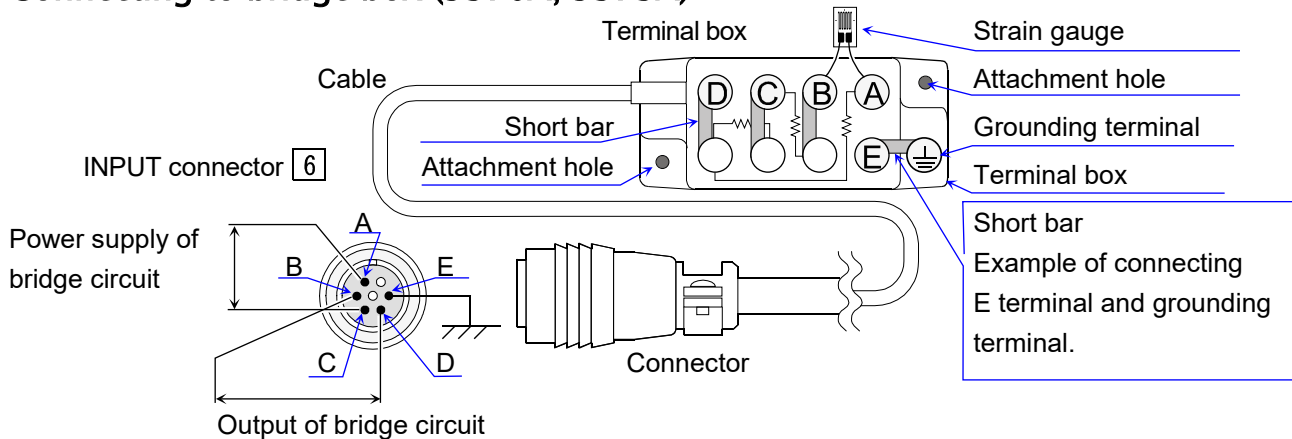

Drawing 20 View of bridge box

#### (A) Wiring of the connector

Refer to the "Drawing 20 View of bridge box" concerning of wiring. Power supply of the bridge circuit are pin A and C. Output of the bridge circuit are pin B and D. The shield wire of cable (E terminal) is pin E.

#### (B) Wiring of the bridge box

Refer to the "Table 17 Wheatstone bridge circuits with strain gauge" for the principal bridge circuit and measurement method of the strain measurement. Refer to the "Drawing 21 Connecting transducer" when connecting transducer that is relayed from bridge box. Refer to the "3.1.3. The Switching Function of E terminal (to select connection of shield wire)" for connection to E terminal.

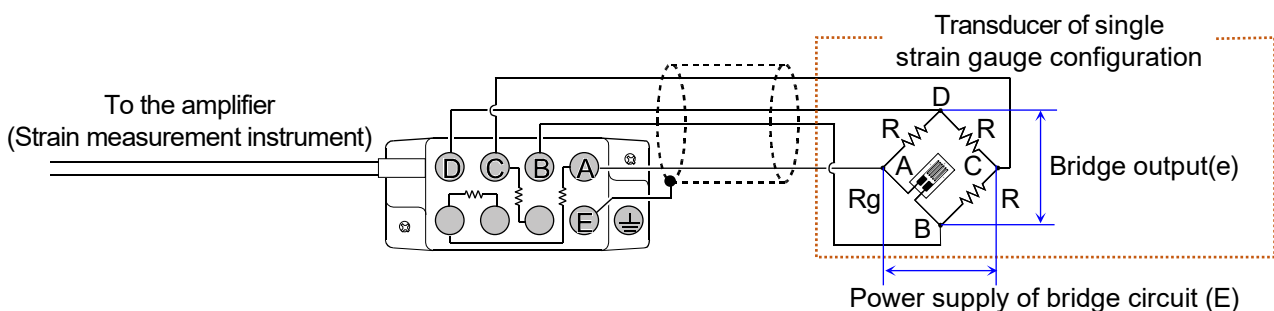

Drawing 21 Connecting transducer

**(C) Influence of cable length**

When the cable length connecting to the amplifier from bridge box or transducer is long, bridge voltage drops down due to conductor resistance of the cable. Refer to the "[Table 14 Example of voltage drop rate at bridge circuit](#)" for drop rate of bridge voltage. In this case, it needs compensation of calibration value because error between output voltage and calibration value occurs.

This amplifier executes the cable length compensation function (CLC) to the cable that is connected to the Wheatstone bridge circuit more than 120  $\Omega$ , supplies the bridge power supply voltage (BV) that voltage drop due to conductor resistance is compensated. Therefore, it can provide precision measurement without consideration about error between output voltage and calibration value.

Refer to the "[3.5. Cable Length Compensation Function \(CLC\)](#)" for the details. Refer to the "[2.4. FNC Settings](#)" for the settings. Refer to the "[3.5. The BAL Function, Indications in Processing](#)" for the execution procedure.

Refer to the "[4.4.1. Compensation of Calibration Value \(CAL\)](#)" for the case that the cable length compensation function (CLC) cannot use due to combination of transducer.

**(D) The way of connecting wires to the bridge box**

Connect wires to the model 5370A and 5373A with fastening screws or soldering.

**(E) Cautions of lead wires**

When the length of lead wire between strain gauge and bridge box is long, even if initial balance establishes, gauge factor may reduce or linearity error may occur.

Shorten lead wires from strain gauge as short as possible. (shorter than 2 m)

Depending on purpose, use strain gauge equipped with lead wires.

The strain gauge equipped with lead wire is calibrated with condition that lead wires are included.

Therefore, don't cut or add lead wire.

### 4.2.3. Measurement using Transducer

#### The relationship between fundamental physical quantities of this amplifier

As an example of single strain gauge configuration,

when a steel pillar of length  $L$  [m] and cross-sectional area  $S$  [m<sup>2</sup>] that a strain gauge is pasted on it is compressed with pressure  $W$  [N] and deformation  $\Delta L$  [m] occurs,

Strain value  $\varepsilon$  is defined as  $\varepsilon$  [ $\mu\text{m}/\text{m}$ ] =  $\frac{\Delta L$  [m]}{L [m]}, Stress  $\sigma$  is defined as  $\sigma$  [Pa] =  $\frac{W$  [N]}{S [m<sup>2</sup>].

Longitudinal elastic modulus  $E$  [Pa] is defined as  $\sigma$  [Pa] =  $E$  [Pa]  $\times$   $\varepsilon$  [ $\mu\text{m}/\text{m}$ ], so it can be written as  $W$  [N] =  $\sigma$  [Pa]  $\times$   $S$  [m<sup>2</sup>] =  $E$  [Pa]  $\times$   $S$  [m<sup>2</sup>]  $\times$   $\varepsilon$  [ $\mu\text{m}/\text{m}$ ].

On the other hand, when resistance value  $R$  [ $\Omega$ ] of strain gauge occurs change of  $\Delta R$  [ $\Omega$ ] by deformation,

Gauge factor  $K$  is defined as  $\frac{\Delta R$  [ $\Omega$ ]}{R [ $\Omega$ ]} =  $K \times \varepsilon$  [ $\mu\text{m}/\text{m}$ ].

Gauge factor  $K$  is designed with  $K = 2$ .

In the condition that the resistance value  $R_g$  [ $\Omega$ ] of strain gauge is defined as  $R_g$  [ $\Omega$ ] =  $R$  [ $\Omega$ ] +  $\Delta R$  [ $\Omega$ ], dummy resistance is defined as  $R$  [ $\Omega$ ] and  $\Delta R$  [ $\Omega$ ]  $\ll$   $R$  [ $\Omega$ ] establishes, the relationship between the output voltage  $e$  [mV] and power supply voltage  $BV$  [V] of the Wheatstone bridge circuit is as follows:

$$e$$
 [mV] =  $\left( \frac{1}{2} - \frac{R$  [ $\Omega$ ]}{R [ $\Omega$ ] +  $\Delta R$  [ $\Omega$ ]} \right) BV [V] =  $\frac{1}{4} \times K \times BV$  [V]  $\times$   $\varepsilon$  [ $\mu\text{m}/\text{m}$ ]

Therefore, **pressure  $W$  [N], output voltage  $e$  [mV] and strain value  $\varepsilon$  [ $\mu\text{m}/\text{m}$ ] are direct proportional relationship.**

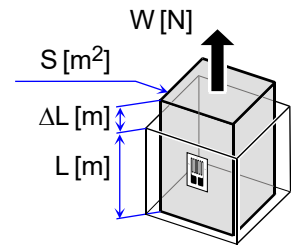

One strain gauge configuration

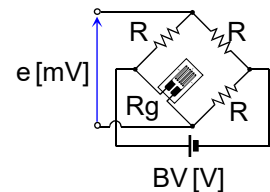

Quarter bridge circuit

**Drawing 22 Transducer**

When the load cell notations and strain value  $\varepsilon$  of loading the rated capacity are used, the relationship between the rated capacity  $RC$  [N] and rated output  $RO$  [mV/V] can be written relationally as  $W$  [N] =  $RC$  [N] and  $e$  [mV] =  $RO$  [mV/V]  $\times$   $BV$  [V].

When single strain gauge configuration and  $K = 2$  are used, the rated output  $RO$  [mV/V] of the transducer can be written as follows :

$$\text{Using } e$$
 [mV] =  $\frac{1}{4} \times K \times BV$  [V]  $\times$   $\varepsilon$  [ $\mu\text{m}/\text{m}$ ],  $RO$  [mV/V] =  $\frac{e$  [mV]}{BV [V]} =  $\frac{1}{2} \times \varepsilon$  [ $\mu\text{m}/\text{m}$ ] establishes,

Therefore, the relationship between the rated output and rated capacity of the strain gauge transducer is  $RO$  [mV/V]  $\times$  2 =  $\varepsilon$  [ $\mu\text{m}/\text{m}$ ].

#### Example of calculation

The relationship between the strain value  $\varepsilon$  [ $\mu\text{m}/\text{m}$ ] occurred at the load cell and the rated output  $RO$  is  $RO$  [mV/V]  $\times$  2 =  $\varepsilon$  [ $\mu\text{m}/\text{m}$ ] when loading the rated capacity [N] to the load cell of the rated output  $RO$  = 1.000 [mV/V]. So, **in an equivalent relationship, it can be written as 1.000 [mV/V] = 2,000 [ $\mu\text{m}/\text{m}$ ].**

**Note** " $\mu\text{m}/\text{m}$ " is described as " $\mu\varepsilon$ " on the panel.

### Transducer using strain gauge

The principal strain gauge transducers receive physical quantity to be measured using elastic material and transfer strain quantity occurred to electrical quantity. The part of elastic material is called the part of sensor or the part of spring element, uses material of high direct proportion, uses material that creep and hysteresis is small, is that strain gauge is pasted and bridge circuit is constructed. The transducer equips temperature compensation and moisture-proof treatment. Refer to each company of transducer if you want detail information.

## Connection between transducer and this amplifier

Connect various transducer and the amplifier like the "Drawing 24 Connector of cable" when combining them. There is the cable of the "Drawing 23 Connection cables" when connecting various transducer and the dynamic strain amplifier. The relay cable and extension cable of our company are made in accordance with the input connector rule of strain measurement by The Japanese Society for Non-Destructive Inspection.

When the cable of transducer has discrete wires that isn't connector, it can connect directly to the bridge box. Refer to the "Drawing 21 Connecting transducer" of the "4.2.2. Bridge Box".

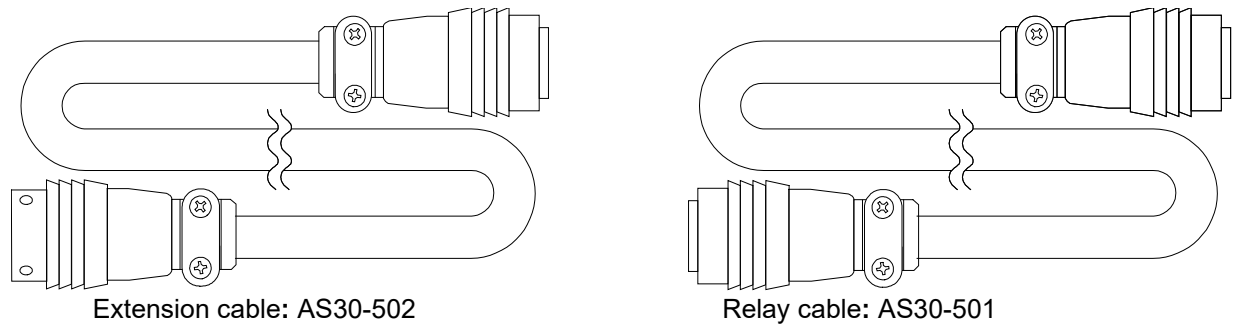

Drawing 23 Connection cables

The part of the bridge circuit

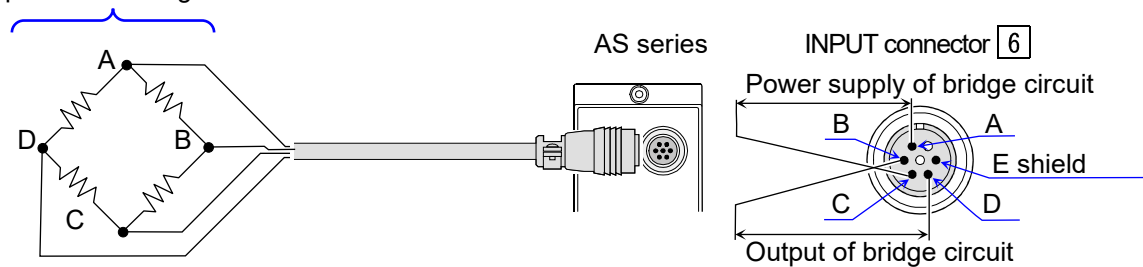

Drawing 24 Connector of cable

## Cautions for Using Transducer

- (A) If installation position of the transducer isn't fixed firmly, it may cause of working error of transducer or generating noise. Install and fix firmly the transducer by referring the manual of each company.
- (B) Even if the transducer and connector are waterproof type generally, maintain the isolation of them so as not to invade water and rain.
- (C) When the cable between the amplifier and transducer is long, high precision measurement is possible using the cable length compensation function (CLC). But there is transducer that cannot use the cable length compensation function (CLC). Refer to the "3.5. Cable Length Compensation Function (CLC)".
- (D) Use the transducer that E terminal and other terminal (A, B, C, D) of the INPUT connector 6 of the amplifier aren't connected when using the transducer.
- (E) Don't install the transducer and connection cable in a strong electric field and magnetic field.

## 4.3. Connection of Output and Load

This amplifier equips 2 way outputs of the OUTPUT 1 and OUTPUT 2.

### OUTPUT 1 3

The rated output voltage and current are  $\pm 10$  V,  $\pm 5$  mA (Load resistance is more than 2 k $\Omega$ ).

The output voltage is indicated at the level indicator 2.

**Example** Connect the voltage input of the recorder (thermal head recorder, data acquisition device, etc.), A/D converter etc.

### OUTPUT 2 8

The rated output voltage and current are  $\pm 10$  V,  $\pm 10$  mA (Load resistance is more than 1 k $\Omega$ ).

The output voltage can change in the range from  $\pm 10$  V to approximate  $\pm 1$  V using the OUTPUT 2 adjustment volume 9 on the front panel. The output voltage is indicated in the numeric display 3.

The scale of the output voltage can be adjusted using them.

**Example** When the transducer of 200 kg  $\rightarrow$  10 V is used and the OUTPUT 2 adjustment volume 9 is turned, the numerical display 3 can adjust so as to display 200 kg  $\rightarrow$  [200.0] display.

(Equivalent relationship: 200 kg = 2 V = [200.0] display)

Refer to the "2.4. FNC Settings" for the way of setting decimal point.

#### 4.3.1. Connecting the recorder to the output

Note for the voltage inputted to the recorder (thermal head recorder, data acquisition device, etc.) from the amplifier. If excessive voltage is inputted, data is saturated and cannot record.

The amplifier equips the function that indicates the "out of range" when output voltage becomes excessive. When output voltage exceeds approximate  $\pm 10.5$  V like the "Drawing 25. The "Out of range" indication of the output", the LED blinks. The level indicator 2 can monitor excessive voltage until approximate 100 Hz.

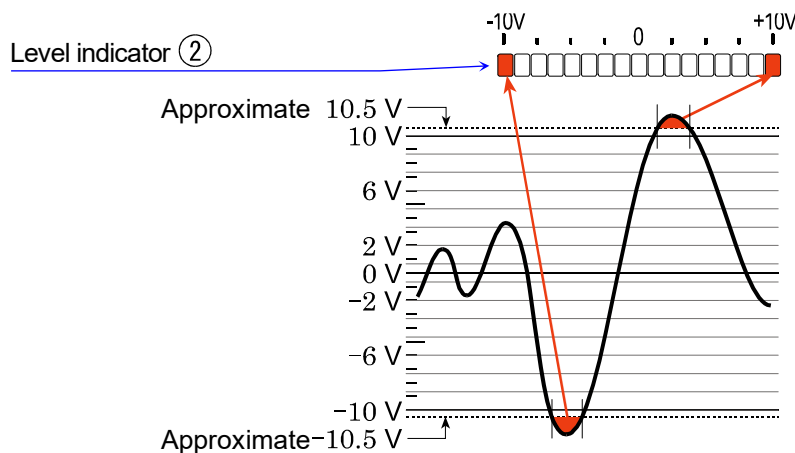

**Drawing 25** The "Out of range" indication of the output

### CAUTION

- The output voltage of OUTPUT 1 3 and OUTPUT 2 8 may output until approximate  $\pm 15$  V in maximum. If not only saturation but also malfunction may occur, take measures using an input protection circuit etc.

## 4.4. How to Read Measurement Value

This section describes how to read measurement value when recording waveform using the recorder (thermal dot recorder, data acquisition device, etc.) connected to the amplifier.

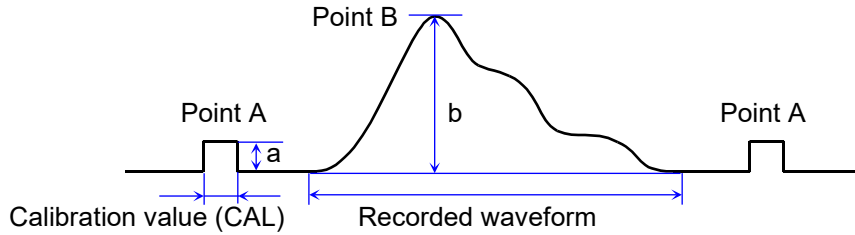

Drawing 26 Measurement value of strain waveform

### Calibration value of strain

The calibration value of strain is displayed at the "Numerical display for calibration value and setting value" (8) (1 to 9,999  $\mu\epsilon$ ), is converted to voltage and is inputted using the [Input of calibration value] switch (18).

**Note** " $\mu\text{m}/\text{m}$ " is described as " $\mu\epsilon$ " on the panel.

### Measurement value using strain gauge

#### Calculation formula

$$\text{Measurement value } [\mu\text{m}/\text{m}] \text{ of point B} = \frac{b \text{ [mm]} (\text{Amplitude of point B})}{a \text{ [mm]} (\text{Amplitude of point A})} \times \text{calibration value (CAL)} [\mu\text{m}/\text{m}]$$

#### Example of calculation

Measurement example by single strain gauge configuration.

Gauge factor : 2.00

Amplitude of calibration value : 10 [mm]

Calibration value (CAL) : 500 [ $\mu\text{m}/\text{m}$ ]

Amplitude of point B : 52 [mm]

$$\text{Measurement value } [\mu\text{m}/\text{m}] \text{ of point B} = \frac{52 \text{ [mm]}}{10 \text{ [mm]}} \times 500 [\mu\text{m}/\text{m}] = 2,600 [\mu\text{m}/\text{m}]$$

### Measurement value in transducer

#### Example of calculation

When rated capacity is loaded to the load transducer of rated capacity 200 [kN] and rated output RO = 2.00 [mV/V] (that is one strain gauge configuration, gauge factor = 2), stain value  $\epsilon$  [ $\mu\text{m}/\text{m}$ ] is equivalent to 4,000 [ $\mu\text{m}/\text{m}$ ] by the following formula.

$$\text{From } e = \frac{1}{4} \times K \times BV \times \epsilon, \text{ deformed formula is } \text{RO} [\text{mV}/\text{V}] = \frac{e \text{ [mV]}}{BV \text{ [V]}} = \frac{1}{2} \times \epsilon [\mu\text{m}/\text{m}]$$

#### Calculation formula

$$\text{Measurement value of transducer [kN]} = \frac{\text{Measured strain quantity } [\mu\text{m}/\text{m}]}{\text{Strain quantity at rated capacity } [\mu\text{m}/\text{m}]} \times \text{rated capacity [kN]}$$

#### Example of calculation

In the condition that strain value becomes 4,000 [ $\mu\text{m}/\text{m}$ ] at rated capacity 200 [kN],

if calibration value is 500 [ $\mu\text{m}/\text{m}$ ], calibration value [kN] is 25 [kN].

$$\text{Calibration value [kN]} = \frac{500 \text{ } [\mu\text{m}/\text{m}]}{4,000 \text{ } [\mu\text{m}/\text{m}]} \times 200 \text{ [kN]} = 25 \text{ [kN]}$$

Load value [kN] at point B of recorded waveform becomes 130 [kN] in the following condition.

Amplitude of calibration value : 10 [mm]. Amplitude of point B : 52 [mm].

$$\text{Load value at point B [kN]} = \frac{52 \text{ [mm]}}{10 \text{ [mm]}} \times 25 \text{ [kN]} = 130 \text{ [kN]}$$



### 4.4.1. Compensation of Calibration Value (CAL)

#### In the case that gauge factor is different

Gauge factor of the amplifier is assumed as 2.00. If strain gauge other than 2.00 is used, calculation of true calibration value (CAL) is as follows:

$$\left( \begin{array}{l} \text{True calibration value} \\ \text{(CAL) } [\mu\text{m/m}] \end{array} \right) = \frac{2.00}{K_c \text{ (gauge factor of used gauge)}} \times \left( \begin{array}{l} \text{Calibration value of the} \\ \text{amplifier (CAL) } [\mu\text{m/m}] \end{array} \right)$$

#### In the case that the strain gauge configuration is different

The calibration value of the amplifier assigns 2.00 to gauge factor and uses equivalent voltage in the single strain gauge configuration.

The output voltage  $e$  [ $\mu\text{V}$ ] of the Wheatstone bridge circuit in the one strain gauge configuration can be described the following formula when these define as gauge factor  $K$ , input voltage  $BV$  [ $\text{V}$ ], strain value  $\varepsilon$  [ $\mu\text{m/m}$ ] and output coefficient  $N$  of the bridge circuit based on gauge configuration.

$$\text{Output voltage } e [\mu\text{V}] = \frac{1}{4} \times K \times BV [\text{V}] \times \varepsilon [\mu\text{m/m}] \times N$$

The calibration value (CAL) of two strain gauges configuration or four strain gauges configuration works like as "Table 18. The relationship between major strain gauge configuration and calibration value (CAL)".

Refer to the "Table 17. Wheatstone bridge circuits with strain gauge" for the details of the Wheatstone bridge circuit and bridge output coefficient  $N$ .

Table 18 The relationship between major strain gauge configuration and calibration value (CAL)

Principal strain gauge configuration		Ture calibration value (CAL) ( Value of numerical display ⑧ / bridge output coefficient N )
Two strain gauges configuration	1 active and 1 dummy strain gauges	Bridge output coefficient $N = 1$
	2 active strain gauges	Bridge output coefficient $N = 2, 1 + \nu$
	Opposite-arm, 2 active strain gauges	Bridge output coefficient $N = 2$
Four strain gauges configuration	4 active strain gauges	Bridge output coefficient $N = 4, 2(1 + \nu)$
Transducer		Bridge output coefficient $N = 1$ ✘

✘ Transducer uses four strain gauge configuration generally and can correspond to output of one strain gauge configuration additionally.

### In the case that the length between bridge box and strain amplifier is long

When the length of cable to connect the bridge box and amplifier is long, voltage drops occurs due to conductor resistance of the cable and occurs difference between output voltage and voltage of the calibration value. Refer to the "Table 14. Example of voltage drop rate at bridge circuit" for the drop rate of the bridge circuit or measure the voltage between terminal A and C and calculate it.

**Example** When voltage drop of the "Table 14 Example of voltage drop rate at bridge circuit" is referred in the condition that temperature is 20 °C, cable length 100 m and gauge resistance is 120 Ω, because voltage between terminal A and C of bridge box drops 5.6 %, measurement value becomes small. Formula of true measurement value is as follows:

$$\text{True measurement value [V]} = \frac{1}{1 - 0.056} \times \text{measurement value [V]}$$

#### Information

This amplifier doesn't need this compensation and measurement when connecting the cable to the Wheatstone bridge circuit that is more than 120 Ω and executing the "3.5. Cable Length Compensation Function (CLC)".

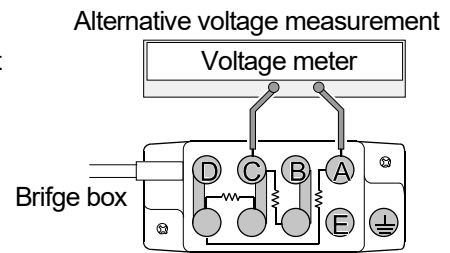

Drawing 27 Voltage measurement at bridge box

## 4.5. Technical Wiring of Bridge Circuit

This section describes explanations concerning of using slip ring or differential transformer.

### 4.5.1. In the case of using spring connections

In case of using 4 slip rings that are connected each arm of bridge.

- ✘ Don't connect terminal E of the input connector [6] to other terminals (A, B, C, D).

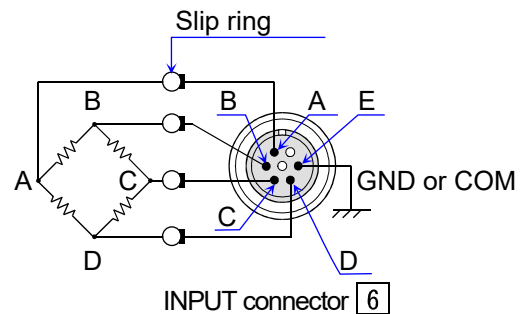

Drawing 28 Spring connections of the Wheatstone bridge circuit

### 4.5.2. In the case of using differential transformer

Differential transformer is designed in high sensitivity generally and outputs large signal relatively.

Therefore, it is necessary to reduce power supply voltage or reduce sensitivity of the amplifier.

Use within the input range of the amplifier. Use differential transformer that excitation frequency is 5 kHz.

Use the AS3603 for measurement instrument.

# 5. Block Diagram & Operating Principle

## 5.1. Measurement Signal Flow

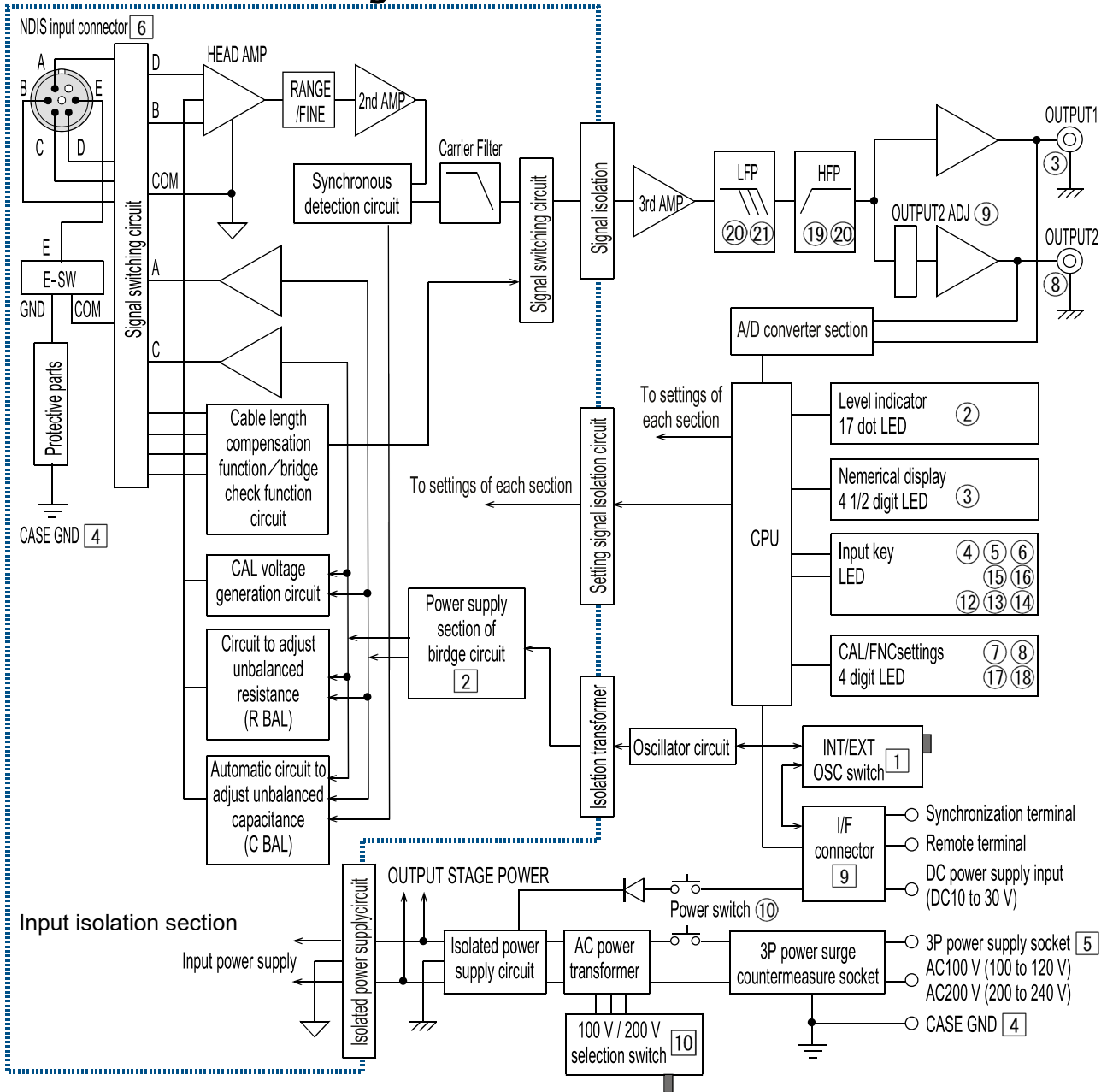

Drawing 29 Block diagram

### The explanation of "Drawing 29 Block diagram"

- The signal is inputted to the INPUT connector [6] from the bridge box or transducer and is amplified using low noise HEAD-AMP. The output signal from the "Circuit to adjust unbalanced resistance (R BAL)" and "Automatic circuit to eliminate unbalanced capacitance (C BAL)" are added to the HEAD-AMP., the automatic balance (resistance balance) is executed, initial unbalanced signal is canceled.
- The calibration signal that is generated at the calibration voltage generation circuit (CAL) using 4 digit numerical settings is added to the input signal. In normal use, the input signal only is passed to next step.
- The signal is amplified at the main amplifier (2nd-AMP.), is executed synchronization detection and filtering, is outputted via the signal isolation circuit, low-pass filter and high-pass filter.

## 5. Block Diagram & Operating Principle — 5.1. Measurement Signal Flow

---

- When the "OSC-INT" is selected for the oscillator circuit, the synchronization signal is generated as stand-alone device and supplies it to external devices.  
When the "OSC-EXT" is selected for the oscillator circuit, the amplifier receives the synchronization signal from connected external device. The synchronization signal is sent to the isolation section via isolation transformer and is used for power supply of the bridge circuit.
- The amplifier equips outputs of 2 systems.  
The voltage potential of the OUTPUT1 [3] is displayed at the level indicator ②.  
The voltage value of the OUTPUT2 [8] is displayed at the numeric display ③.
- After the voltage of AC power supply is rectified, the voltage of the DC power supply is added to it.  
When both AC power supply and DC power supply are used, the power supply of higher input voltage is used.

## 6. Options

### 6.1. Storage Case

#### 6.1.1. List of storage case

Select a storage case with considering number of measurement channels.

Available function will change according to kind of amplifier installed in the storage case.

Table 19 List of storage case

Type	Model	Name	Descriptions
Bench top case	AS16-104	4CH bench top case	Available function on all amplifiers: The input of calibration value, BAL function, KEY LOCK, ON/OFF of batch power supply, synchronization with other storage case.
	AS16-105	6CH bench top case	
	AS16-106	8CH bench top case	
Rack mount case	AS16-107	8CH rack mount case	

#### 6.1.2. Names of switches and parts on the storage case

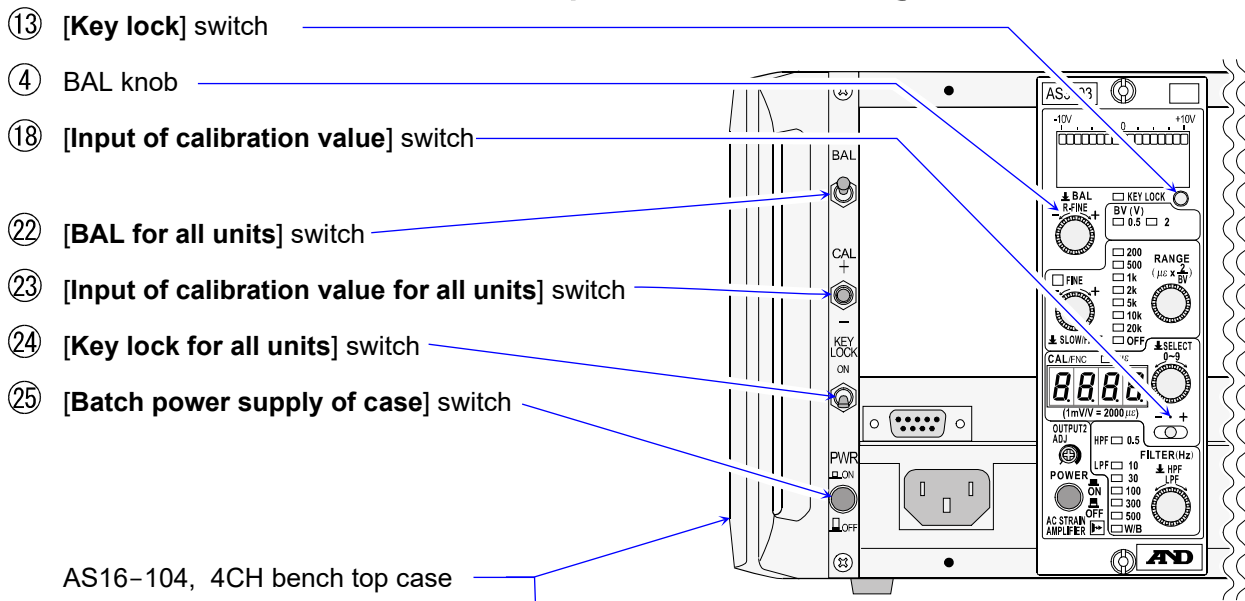

AS16-104, 4CH bench top case

Drawing 30 Example of front panel of storage case

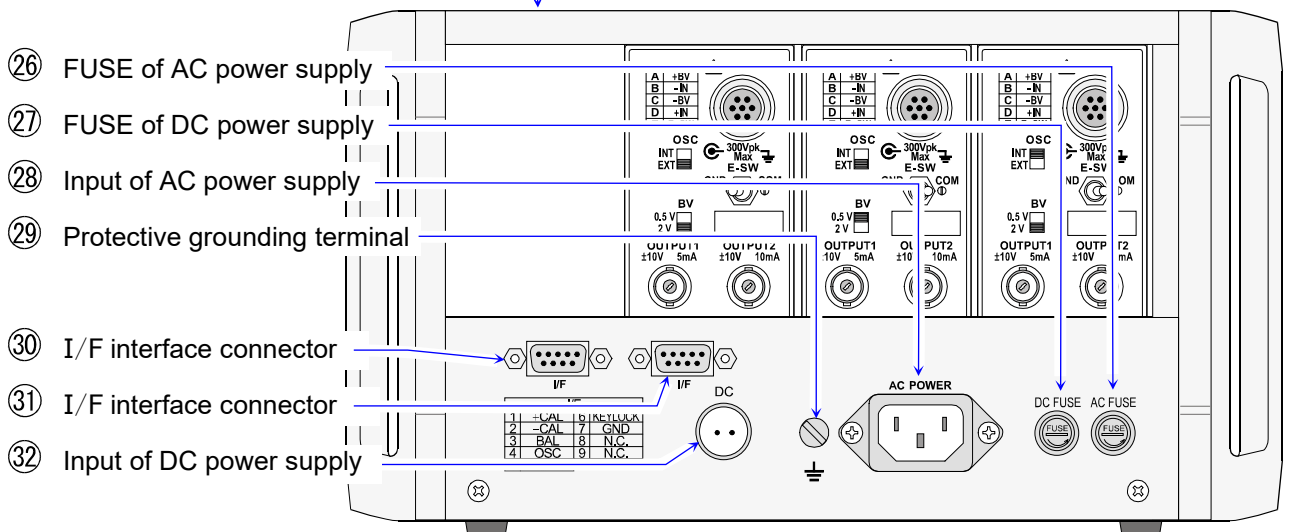

Drawing 31 Example of rear panel of storage case

Table 20 Front panel of storage case

No.	Name	Functions, operations and responses
②②	[BAL for all units] knob Bridge check function (BRC) / Cable length compensation function (CLC) / Automatic range function (ARG) / Automatic balance	<ul style="list-style-type: none"> <li>□ When the [BAL for all units] knob ②② is lowered (turns on), the BAL function [the bridge check function (BRC), cable length compensation function (CLC) and automatic range function (ARG), the automatic balance (resistance balance)] is executed for all amplifiers.</li> <li>□ For all amplifiers, the BAL function is executed according to the FNC settings of each amplifier.</li> <li>□ When multiple storage cases are connected using synchronization cable and synchronize, the BAL function are executed identically for all units.</li> <li>□ Operate each BAL knob ④ on each amplifier when executing separately the BAL function of each amplifier.</li> <li>□ Press and hold the BAL knob ④ of each amplifier to stop repeating display of error message at the bridge check function (BRC).</li> </ul>
②③	[INPUT OF CALIBRATION VALUE for all units] switch (+CAL, -CAL)	<ul style="list-style-type: none"> <li>□ The calibration values that are specified using the SELECT knob ①⑦ are inputted for all amplifiers when operating the [Input of calibration value for all units] switch ②③ on the storage case. The calibration value (+CAL) of "positive (tension)" is input when tilting lever to the upper side. The calibration value (-CAL) of "negative (compression)" is input when tilting lever to the lower side. <b>Please put lever back to the center (OFF position) after use.</b></li> <li>□ The [Input of calibration value for all units] switch ②③ has priority than the [Input of calibration value] switch ①⑧ of each amplifier.</li> <li>□ When multiple storage cases are connected using the synchronization cable, calibration value is inputted to all amplifiers similarly.</li> <li>□ If it necessary to input calibration value to the amplifier separately, operate the [Input of calibration value] switch ①⑧ after confirming that the [Input of calibration value for all units] switch ②③ is OFF.</li> </ul> <p><b>Caution</b> If the lever of the [Input of calibration value for all units] switch ②③ isn't the center (OFF position), the [Input of calibration value] switch ①⑧ of each amplifier cannot operate.</p>
②④	[Key lock for all units] switch KEY LOCK	<ul style="list-style-type: none"> <li>□ When the lever of the [Key lock for all units] switch ②④ is tilted to the upper side (is turned on), all amplifiers are locked and the key lock LED ①② lights.</li> <li>□ Target of key lock: BAL knob ④, RANGE knob ①⑤, FINE knob ⑥, SELECT knob ①⑦, FILTER knob ②⑩ and key lock switch ①③ of each amplifier.</li> <li>□ When the [Key lock] switch ①③ is preset, even if the [Key lock for all units] switch ②④ is "unlock", the [Key lock] switch ①③ is effectiveness.</li> <li>□ When multiple storage cases are connected using the synchronization cable, the lock key is effectiveness. similarly.</li> <li>□ The [Input of calibration value for all units] switch ②③ and [BAL for all units] knob ②② can use always.</li> </ul>

No.	Name	Functions, operations and responses																					
⑳	AC power supply socket	<p><b>Connection of power supply cable</b></p> <ul style="list-style-type: none"> <li>❑ Accessory power cable can use for AC 100 V system (AC100 V to 120 V) with B plug.</li> </ul> <p><b>Note</b> Please confirm that your local voltage and receptacle type. Select a voltage at the [AC power supply <b>voltage selector</b>] switch of each amplifier before connecting the power cable.</p>																					
㉑	Protective grounding terminal	<ul style="list-style-type: none"> <li>❑ Use a grounding wire of AWG16 and fasten using screw.</li> <li>❑ When the amplifier is installed in the storage case, protective grounding terminal of the amplifier, protective grounding terminal of the storage case and grounding terminal of power supply socket are connected and become the same voltage potential.</li> </ul> <p><b>⚠ WARNING</b> Connect the protective grounding terminal for safety.</p>																					
㉒ ㉓ ㉔	I/F interface connector	<ul style="list-style-type: none"> <li>❑ The electrical interface of the storage case. The all amplifiers installed in storage case can control.</li> <li>❑ Both I/F interface connectors are the same function.</li> </ul> <table border="1" data-bbox="518 853 1062 1290"> <thead> <tr> <th>Function</th> <th colspan="2">Terminal pair</th> </tr> </thead> <tbody> <tr> <td>Input of calibration value (+CAL)</td> <td>+CAL 1 pin</td> <td>GND 7 pin</td> </tr> <tr> <td>Input of calibration value (-CAL)</td> <td>-CAL 2 pin</td> <td>GND 7 pin</td> </tr> <tr> <td>Execution of the BAL function</td> <td>BAL 3 pin</td> <td>GND 7 pin</td> </tr> <tr> <td>Synchronization signal (OSC)</td> <td>OSC 4 pin</td> <td>AGND 5 pin</td> </tr> <tr> <td>GND</td> <td>GND 7 pin</td> <td>-</td> </tr> <tr> <td>KEY LOCK</td> <td>KEY LOCK 6 pin</td> <td>GND 7 pin</td> </tr> </tbody> </table> <div data-bbox="1070 864 1414 1167" style="display: inline-block; vertical-align: top;"> <p>Pin layout from rear view</p> </div> <ul style="list-style-type: none"> <li>❑ The synchronization signal (OSC) can input or output using 4 and 5 pin.</li> <li>❑ When 1 and 7 pin are connected (contact input), the input of calibration value (-CAL) is executed to all amplifiers.</li> <li>❑ When 2 and 7 pin are connected (contact input), the input of calibration value (+CAL) is executed to all amplifiers.</li> <li>❑ When 6 and 7 pin are connected (contact input), the KEY LOCK is executed to all amplifiers.</li> <li>❑ When 3 and 7 pin are connected (contact input), the BAL function [of the bridge check function (BRC), cable length compensation function (CLC), automatic range function (ARG) and automatic balance (resistance balance)] is executed to all amplifiers.</li> </ul>	Function	Terminal pair		Input of calibration value (+CAL)	+CAL 1 pin	GND 7 pin	Input of calibration value (-CAL)	-CAL 2 pin	GND 7 pin	Execution of the BAL function	BAL 3 pin	GND 7 pin	Synchronization signal (OSC)	OSC 4 pin	AGND 5 pin	GND	GND 7 pin	-	KEY LOCK	KEY LOCK 6 pin	GND 7 pin
Function	Terminal pair																						
Input of calibration value (+CAL)	+CAL 1 pin	GND 7 pin																					
Input of calibration value (-CAL)	-CAL 2 pin	GND 7 pin																					
Execution of the BAL function	BAL 3 pin	GND 7 pin																					
Synchronization signal (OSC)	OSC 4 pin	AGND 5 pin																					
GND	GND 7 pin	-																					
KEY LOCK	KEY LOCK 6 pin	GND 7 pin																					

No.	Name	Functions, operations and responses
③① ③①	I/F interface connector	<p><b>Procedure to execute automatic range (ARG)</b></p> <p>Store "OFF" to the RANGE before executing the automatic range function (ARG).</p> <ol style="list-style-type: none"> <li>1. In advance, select a voltage of the automatic range function (ARG).</li> <li>2. When the RANGE is set to "OFF" using remote operation from this interface connector, connect 1, 2 and 7 pin at the same time. The "OFF" of the RANGE LED ①⑥ lights.</li> <li>3. Disconnect wires of 1, 2 and 7 pin.</li> <li>4. Connect (contact input) wires of 3 and 7 pin to execute the automatic range function (ARG) of the BAL function.</li> </ol>
③②	DC power supply input plug	<ul style="list-style-type: none"> <li>□ Connect option DC power cable that is connected to DC power supply (DC10 V to 30 V).</li> <li>□ When the amplifier is installed in storage case and is connected to battery (DC12 V, DC24 V: DC10 V to 30 V), voltage drop may occur due to cable length and diameter of wires of power cable. When multiple channels are used and voltage drop occur due to extension of DC power cable, voltage of the DC power supply input of the amplifier may become lower than 10 V that is range of power supply voltage.</li> </ul> <p><b>Example</b></p> <p>Option DC power supply cable is 1.25 mm<sup>2</sup>.            When 8 channels are installed, the current is 0.4 A × 8 = 3.2 A.            When cable is used with 10 m length, voltage drop becomes 0.5 V.            Similarly, when cable is 0.75 mm<sup>2</sup> and cable length is 10 m, voltage drop becomes 1.65 V. Therefore, consider voltage drop and input power supply voltage or select again diameter and length of cable.</p>

### 6.1.3. Installing the amplifier into storage case

The procedure when installing the amplifier into the storage case: Attach the ditch of the bottom face on the amplifier and guide of the storage case, slide the amplifier gently so as to connect power socket and interface connector surely. Install all amplifiers into the storage case and fasten two knurling screws for upper and lower fixation on the front panel. Knurling screws are included in accessory of the storage case.

### 6.1.4. How to use blank panel

Use the blank panel to cover channel space not to be installed. Use screw holes for fixing the amplifier and two knurling screws for upper and lower fixation when attaching the blank panel.



### 6.1.5. Cautions to use the rack mount case

The rack mount case is the storage case for 19 inch rack.

Put the rails both right and left side on rails of the rack, fix it using screws of 4 mounting holes of the front panel.

#### (A) Installing one rack mount case

When a rack mount case not to install in the 19 inch rack is placed on floor (or desk) temporarily, put blocks under 4 corner of the rack mount case and lift up it 20 mm height or more because the rack mount case doesn't equip feet.

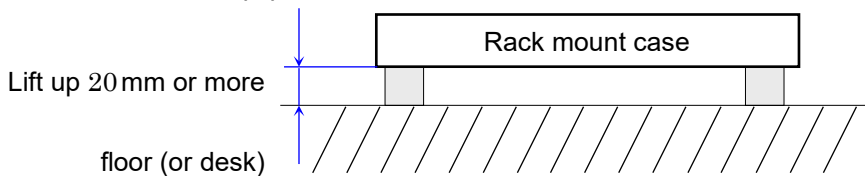

**Drawing 32 Installation of the rack mount case**

### ! CAUTION

- ❑ Don't put a rack mount case on desk, floor, etc. because it doesn't equip feet. It cannot radiate heat and causes failure.

#### (B) Installing multiple rack mount cases

When multiple rack mount cases are installed them in the 19 inch rack, radiate them using fan units inserted between them so as to maintain precision measurement.

Decide number of fan unit referring the "[Table 21 The relationship between number of cooling fans and number of rack mount cases](#)" because temperature inside rack mount case rises due to number of cases installed, condition of power consumption and ambient temperature, lowering of reliability.

Table 21 The relationship between number of cooling fans and number of rack mount cases

Number of rack mount case	Harsh environment
	Number of fan unit B
1 ~ 3	1
3 ~ 6	2
6 ~ 9	3

Power supply voltage	AC110 V (+10 %)
Output voltage and current	+10 V, 10 mA
Operation temperature	+50 °C (Ambient temperature)

- ❑ Use fan unit A for promoting forced vertical ventilation. When rising breeze is protected (because depth of slant line case is different), use fan unit A.
- ❑ Use fan unit B for promoting natural ventilation. Arrange fan unit B in the rate of 3:1 concerning of cases and fan units. Attach fan unit beside case.
- ❑ Consult to your dealer for installation when installing them yourself.

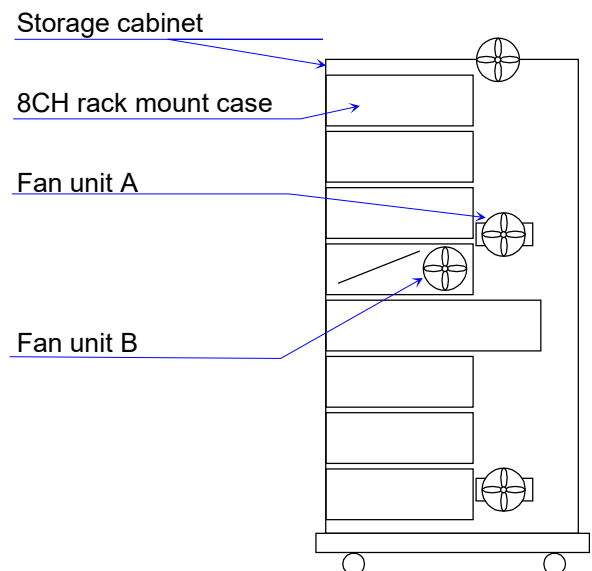

### 6.1.6. How to use mixed with conventional products

#### (1) When conventional products of the AS1603, AS1703, AS1803R are mixed and used

The case used for AS1603, AS1703 and AS1803R can use to the AS3000 series directly.

Even if the AS3000 series and others are installed in a case, the **[BAL for all units]** knob (22), **[INPUT OF CALIBRATION VALUE for all units]** switch (23), **[Key lock for all units]** switch (24) and **[Batch power supply of case]** switch (25) can use. However, the AC strain amplifier needs to use the bridge power supply of the same frequency because of synchronization. The combination of products to be able to synchronize are as follows:

When the bridge power supply frequency is the same, there are no restrictions for slots installed.

Set "INT" of the OSC switch of one, set "EXT" of the OSC switch of the others including amplifiers that are turned off.

Table 22 Available models to mix

Bridge power supply frequency	5 kHz	12.5 kHz	25 kHz
AS1000 series	AS1603, AS1803R	-	AS1703
AS3000 series	AS3603, AS3803	AS3503, AS3903	AS3703

#### (2) When remote operation is performed from the I/F interface of storage case that conventional products are mixed

Even if the AS3000 series and others are installed in a case and use remote operation, each function of the **[BAL for all units]** knob, **[INPUT OF CALIBRATION VALUE for all units]** switch and **[Key lock for all units]** switch can similarly operate. Additionally, when the automatic range function of the AS3000 is used, it needs to set the RANGE to "OFF" before executing the BAL function. The way of executing this setting from remote operation, contact both +CAL terminal and -CAL terminal to GND terminal at the same time. Then the RANGE becomes "OFF" and "OFF" LED of the RANGE LED (16) turns on.

Because older product than the AS3000 doesn't equip this function, the operation is different against the AS3000.

Table 23 Behavior when executing  $\pm$ CAL ON from the I/F interface at the same time

Type	Model	Execution of CAL	Execution of RANGE
AC strain amplifier	AS1603, AS1703, AS1803R	+CAL input	RANGE isn't executed
DC strain amplifier	AS2503, AS2603	+CAL input	RANGE isn't executed
AS3000 series AC strain amplifier	AS3603, AS3803, AS3503, AS3903, AS3703	Either $\pm$ CAL	RANGE: OFF Detecting edge ✖

- ✖ When both the +CAL terminal and -CAL terminal are shorted to the GND at the same time, either +CAL or -CAL has effective, the RANGE becomes to "OFF" in the condition that the CAL is inputted. Additionally, when the KEY LOCK isn't used, the RANGE can switch manually. Remove the +CAL terminal and -CAL terminal from the GND terminal before executing the BAL function. If the BAL function is executed in the condition that either  $\pm$ CAL is inputted, the BAL becomes (except RANGE : OFF) or automatic range function becomes (RANGE : OFF).

**(3) AC voltage settings when products are mixed and used in a storage case**

Select single power supply voltage of all products either AC 100V system (AC100 to 120 V) or AC 200 V system (AC200 to 240 V) when multiple products that can select power supply voltage are installed in the storage case.

Refer to manual of each product how to select power supply voltage.

Moreover, in case of mixed use of products that power supply voltage is only used AC120V or AC220V, provide power supply to fit to their specifications.

## 7. Maintenance

### 7.1. Confirmation Items

The product is shipped after strict inspection, but motion error may occur due to natural failure of parts and performance degradation due to deterioration and malfunction, defective of wiring.

When motion error occurs, it necessary to investigate cause and repair them. Refer to the the following notes and "[Table 16 Precautions before measurement](#)" when significant performance isn't gotten.

Moreover, when cause cannot be found or malfunction occurs, record circumstance and phenomenon of them, contact your dealer.

#### **WARNING**

**Check range of power supply voltage**

Voltage range of power supply :	AC voltage	AC85 to 132 V	50, 60 Hz
	AC voltage	AC170 to 264 V	50, 60 Hz
	DC voltage	DC10 to 30 V	

**Check range of input starin range**

Input range	:	200 [ $\mu\text{m}/\text{m}$ ] to 200,000 [ $\mu\text{m}/\text{m}$ ]	AS3603, AS3803
Input range	:	500 [ $\mu\text{m}/\text{m}$ ] to 500,000 [ $\mu\text{m}/\text{m}$ ]	AS3503, AS3703, AS3903

**Check voltage of common mode**

Tolerance voltage between input and output : AC1 kV for 1 minute

**Ground protective grounding terminal securely.**

Confirm the following items after checking the power supply voltage.

#### In case of error 1 The amplifier cannot make balance.

Set the RANGE knob (15) to "OFF". "OFF" of the RANGE LED (16) lights.

Does the green LED of the level indicator (2) light ? Is "0.000" displayed in the numeric display (3) ?

— No: Adjustment inside unit needs.

Yes: Connect bridge box and sensor to the input. Turn the RANGE knob (15) toward OFF → 200.  
Make balance using the bridge check function (BRC).

As result of the bridge check function (BRC), is Good displayed ?

— No: Do correction of strain gauge, transducer and input cable, as centered on point that disconnection or short is found.

Yes: Confirm bridge voltage. Is the OSC switch set to INT ?

Is terminal A or C of bridge box connected to common terminal E ?

— Yes: Repair the connection.

No: Is terminal B or D of bridge box connected to common terminal E ?

#### Drawing 33 Flowchart (1) of confirmation items

**In case of error 2 Output doesn't get. (Indicator doesn't swing)**

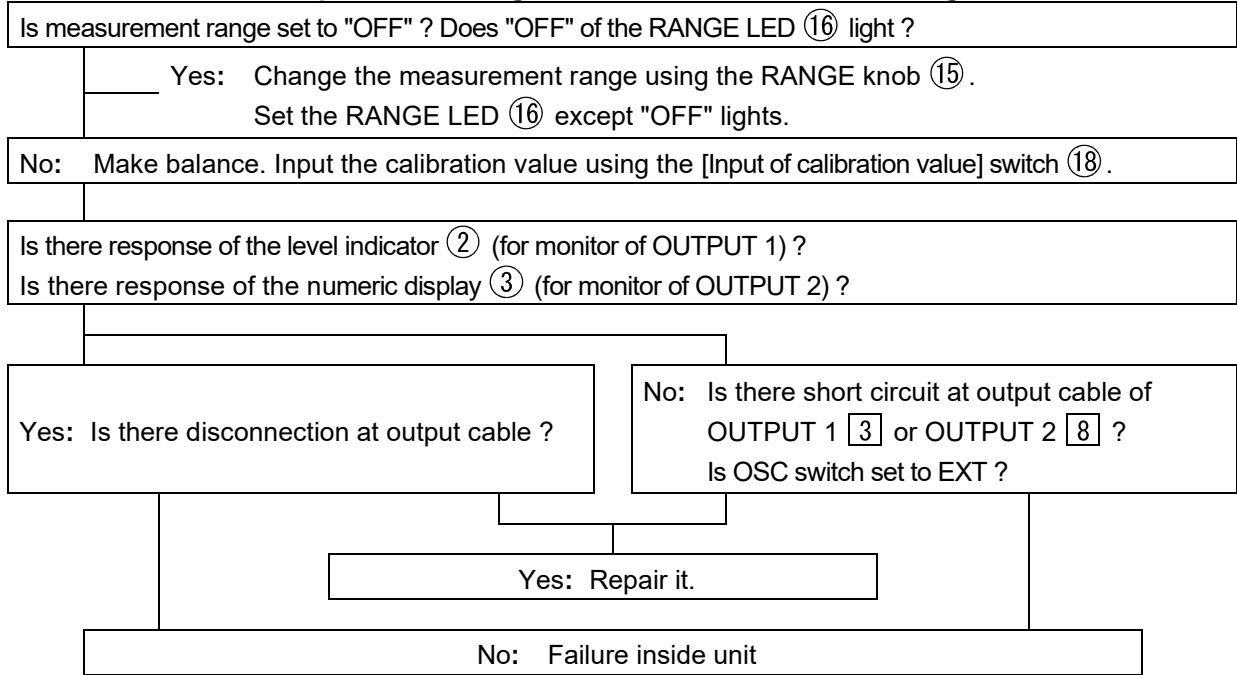

**Drawing 34 Flowchart (2) of confirmation items**

**In case of error 3 The zero point drifts after balancing**

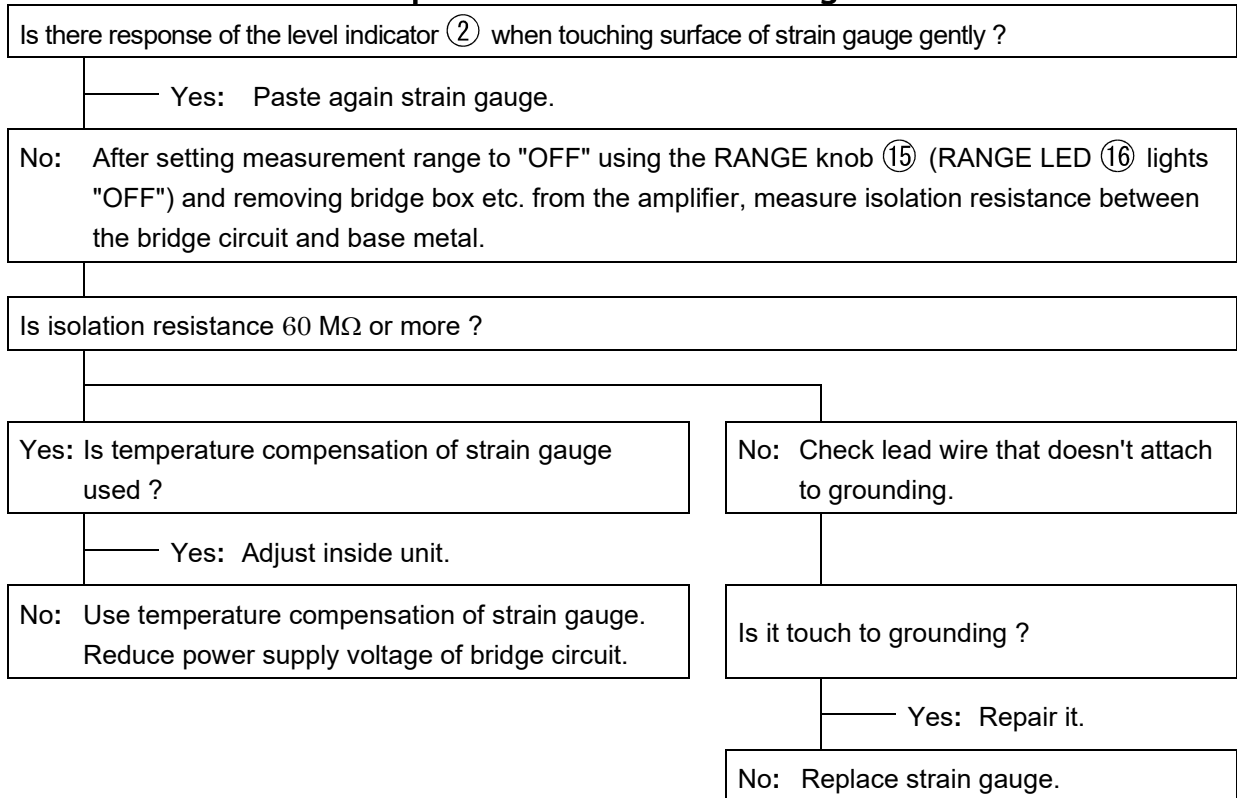

**Drawing 35 Flowchart (3) of confirmation items**

## 7.2. Changing AC Voltage of Power Supply

This section describes how to switch AC power supply voltage. Specify a power supply voltage in accordance with the following procedure.

1. Set the [Power] switch ⑩ to "OFF". Remove power cable and input / output cables from the amplifier.
2. There is the [AC power supply **voltage selector**] switch ⑩ on the bottom face of the amplifier like the "Drawing 36 The selection switch of AC power supply voltage". Select a power supply voltage either AC100 V system (AC100 to 120 V) or AC200 V system (AC200 to 240 V).

**Caution** There is "OFF position" between "position of AC100 V system" and "position of AC200 V system" of the [AC power supply **voltage selector**] switch ⑩ for safety. This neutral "OFF position" doesn't supply power.

Fuse is built in the amplifier.

3. When AC100 V system (AC100 to 120 V) is used, accessory power cable can be used.  
When AC200 V system (AC200 to 240 V) is used, the AC power supply cable needs to change to plug type adapting to your local region. Specify plug type of the AC power supply cable when ordering your amplifier.

### WARNING

- When power supply voltage is changed, set the [Power] switch ⑩ to "OFF", remove power cable from the power supply socket ⑤. Don't choose mistaken voltage.

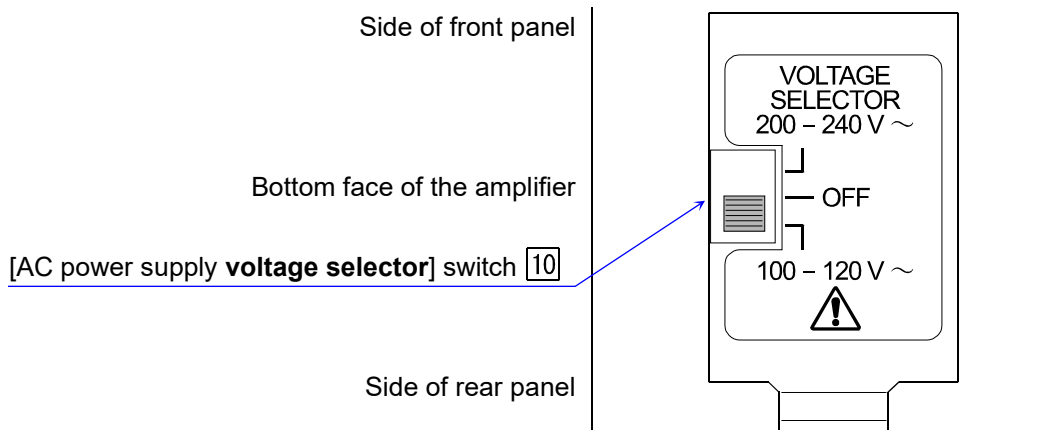

Drawing 36 The selection switch of AC power supply voltage

## 8. Specifications

### 8.1. Specifications

Table 24 Specification list of the AS3000 series

Item	Specifications								
Number of channels	1 channel / unit								
Bridge resistance	60 to 1,000 $\Omega$								
gauge factor	2.00								
Bridge power supply voltage (BV)	<table> <tr> <td>Bridge power supply voltage</td> <td>AC 0.5 V, 2 V</td> </tr> <tr> <td>AS3603, AS3803</td> <td>5 kHz sine wave</td> </tr> <tr> <td>AS3503, AS3903</td> <td>12.5 kHz sine wave</td> </tr> <tr> <td>AS3703</td> <td>25 kHz sine wave</td> </tr> </table>	Bridge power supply voltage	AC 0.5 V, 2 V	AS3603, AS3803	5 kHz sine wave	AS3503, AS3903	12.5 kHz sine wave	AS3703	25 kHz sine wave
Bridge power supply voltage	AC 0.5 V, 2 V								
AS3603, AS3803	5 kHz sine wave								
AS3503, AS3903	12.5 kHz sine wave								
AS3703	25 kHz sine wave								
Synchronization input / output signal (OSC)	AC 2.5 V								
[E terminal selector] switch (E-SW)	The E-SW can select connection destination of the E terminal (shield wire) of the input cable to either the COM (input common) or GND (grounding voltage potential at chassis via protective parts).								
Bridge check function	The function detects and indicates "disconnection and short circuit in the bridge circuit more than 120 $\Omega$ " and "disconnection of the input cable". The ON/OFF of the function can be switched at the FNC settings.								
Cable length compensation function	The function compensates voltage drop due to cable length between the bridge circuit more than 120 $\Omega$ and amplifier. The ON/OFF of the function can be switched at the FNC settings.								
Balance adjusting range (Automatic balance)	Deviation of resistance value : $\pm 2\%$ ( $\pm 10,000 \mu\text{m/m}$ ) Unbalance of capacitance : Approximately 2,000 pF								
Accuracy to adjust balance	<table> <tr> <td>AS3603, AS3803 :</td> <td>Within <math>\pm 0.4 \mu\text{m/m}</math></td> <td>(RANGE = 200, FINE = x1, BV = 2 V)</td> </tr> <tr> <td>AS3503, AS3703, AS3903 :</td> <td>Within <math>\pm 1.0 \mu\text{m/m}</math></td> <td>(RANGE = 500, FINE = x1, BV = 2 V)</td> </tr> </table>	AS3603, AS3803 :	Within $\pm 0.4 \mu\text{m/m}$	(RANGE = 200, FINE = x1, BV = 2 V)	AS3503, AS3703, AS3903 :	Within $\pm 1.0 \mu\text{m/m}$	(RANGE = 500, FINE = x1, BV = 2 V)		
AS3603, AS3803 :	Within $\pm 0.4 \mu\text{m/m}$	(RANGE = 200, FINE = x1, BV = 2 V)							
AS3503, AS3703, AS3903 :	Within $\pm 1.0 \mu\text{m/m}$	(RANGE = 500, FINE = x1, BV = 2 V)							
Input range in maximum	<table> <tr> <td>AS3603, AS3803 :</td> <td><math>\pm 200,000 \mu\text{m/m}</math></td> <td>(RANGE = 20 k, FINE = x2.5, BV = 0.5 V)</td> </tr> <tr> <td>AS3503, AS3703, AS3903 :</td> <td><math>\pm 500,000 \mu\text{m/m}</math></td> <td>(RANGE = 50 k, FINE = x2.5, BV = 0.5 V)</td> </tr> </table>	AS3603, AS3803 :	$\pm 200,000 \mu\text{m/m}$	(RANGE = 20 k, FINE = x2.5, BV = 0.5 V)	AS3503, AS3703, AS3903 :	$\pm 500,000 \mu\text{m/m}$	(RANGE = 50 k, FINE = x2.5, BV = 0.5 V)		
AS3603, AS3803 :	$\pm 200,000 \mu\text{m/m}$	(RANGE = 20 k, FINE = x2.5, BV = 0.5 V)							
AS3503, AS3703, AS3903 :	$\pm 500,000 \mu\text{m/m}$	(RANGE = 50 k, FINE = x2.5, BV = 0.5 V)							
Voltage sensitivity	<table> <tr> <td>AS3603, AS3803 :</td> <td><math>\pm 10 \text{ V} / \pm 200 \mu\text{m/m}</math></td> <td>(RANGE = 200, FINE = x1, BV = 2 V)</td> </tr> <tr> <td>AS3503, AS3703, AS3903 :</td> <td><math>\pm 10 \text{ V} / \pm 500 \mu\text{m/m}</math></td> <td>(RANGE = 500, FINE = x1, BV = 2 V)</td> </tr> </table>	AS3603, AS3803 :	$\pm 10 \text{ V} / \pm 200 \mu\text{m/m}$	(RANGE = 200, FINE = x1, BV = 2 V)	AS3503, AS3703, AS3903 :	$\pm 10 \text{ V} / \pm 500 \mu\text{m/m}$	(RANGE = 500, FINE = x1, BV = 2 V)		
AS3603, AS3803 :	$\pm 10 \text{ V} / \pm 200 \mu\text{m/m}$	(RANGE = 200, FINE = x1, BV = 2 V)							
AS3503, AS3703, AS3903 :	$\pm 10 \text{ V} / \pm 500 \mu\text{m/m}$	(RANGE = 500, FINE = x1, BV = 2 V)							
Measurement range (RANGE)	<table> <tr> <td>AS3603, AS3803 :</td> <td>200, 500, 1 k, 2 k, 5 k, 10 k, 20 k (<math>\mu\epsilon \times 2 / \text{BV}</math>), OFF</td> </tr> <tr> <td>AS3503, AS3703, AS3903 :</td> <td>500, 1 k, 2 k, 5 k, 10 k, 20 k, 50 k (<math>\mu\epsilon \times 2 / \text{BV}</math>), OFF</td> </tr> </table>	AS3603, AS3803 :	200, 500, 1 k, 2 k, 5 k, 10 k, 20 k ( $\mu\epsilon \times 2 / \text{BV}$ ), OFF	AS3503, AS3703, AS3903 :	500, 1 k, 2 k, 5 k, 10 k, 20 k, 50 k ( $\mu\epsilon \times 2 / \text{BV}$ ), OFF				
AS3603, AS3803 :	200, 500, 1 k, 2 k, 5 k, 10 k, 20 k ( $\mu\epsilon \times 2 / \text{BV}$ ), OFF								
AS3503, AS3703, AS3903 :	500, 1 k, 2 k, 5 k, 10 k, 20 k, 50 k ( $\mu\epsilon \times 2 / \text{BV}$ ), OFF								
Fine adjustment range (FINE)	Continuous adjustment including multiple RANGE, adjustment speed of two steps								
Internal calibrator (+CAL, -CAL)	<table> <tr> <td>Range of calibration value :</td> <td><math>\pm 1 \sim 9,999 \mu\epsilon</math></td> <td>* <math>\mu\epsilon = \mu\text{m/m}</math></td> </tr> <tr> <td>Accuracy of calibration value :</td> <td><math>\pm(0.5\% \text{ rdg} + 0.5 \mu\text{m/m})</math></td> <td></td> </tr> </table>	Range of calibration value :	$\pm 1 \sim 9,999 \mu\epsilon$	* $\mu\epsilon = \mu\text{m/m}$	Accuracy of calibration value :	$\pm(0.5\% \text{ rdg} + 0.5 \mu\text{m/m})$			
Range of calibration value :	$\pm 1 \sim 9,999 \mu\epsilon$	* $\mu\epsilon = \mu\text{m/m}$							
Accuracy of calibration value :	$\pm(0.5\% \text{ rdg} + 0.5 \mu\text{m/m})$								

## 8. Specifications — 8.1. Specifications

Item	Specifications
Automatic range function	The function adjusts automatically output voltage using the RANGE and FINE so that it becomes to specified voltage value when inputting the preset calibration value from internal calibrator. The output voltage (of OFF, 5 V, 8 V, 10 V) can be selected at the FNC settings.
Non-linearity	AS3503, AS3603, AS3803, AS3903 : $\pm 0.1$ % of RANGE AS3703 : $\pm 0.2$ % of RANGE
Frequency characteristics (W/B)	AS3603, AS3803 : DC to 2 kHz with in $\pm 10$ % AS3503, AS3903 : DC to 5 kHz with in $\pm 10$ % AS3703 : DC to 10 kHz with in $\pm 10$ %
High-pass filter (HPF)	0.5 Hz 2 poles Butterworth type (-3 dB at setting display frequency, Filter descent characteristics -12 dB/oct)
Low-pass filter (LPF)	AS3603, AS3803 : 10, 30, 100, 300, 500 Hz AS3503, AS3703, AS3903 : 10, 30, 100, 500, 3 kHz 4 poles Butterworth type (-3 dB at setting display frequency, Filter descent characteristics -24 dB/oct)
Stability	Zero Within $\pm 0.1 \mu\text{m/m}/^\circ\text{C}$ , Within $\pm 0.5 \mu\text{m/m}/24\text{h}$ Sensitivity AS3503, AS3603, AS3703 : Within $\pm 0.02 \%/^\circ\text{C}$ , Within $\pm 0.2 \%/24\text{h}$ AS3803, AS3903 : Within $\pm 0.05 \%/^\circ\text{C}$ , Within $\pm 0.2 \%/24\text{h}$
Noise	AS3603, AS3803 : $2.0 \mu\text{m/m}$ p-p input conversion value at RANGE = 200 AS3503, AS3903 : $5.0 \mu\text{m/m}$ p-p input conversion value at RANGE = 500 AS3703 : $7.0 \mu\text{m/m}$ p-p input conversion value at RANGE = 500 (W/B, FINE = x1, BV = 2 V, 120 $\Omega$ bridge)
Output (OUTPUT 1, OUTPUT 2)	OUTPUT 1 $\pm 10$ V $\pm 5$ mA load of 2 k $\Omega$ or more OUTPUT 2 $\pm 10$ V $\pm 10$ mA load of 1 k $\Omega$ or more Output resistance : 0.5 $\Omega$ or less, Load capacitance : Operable up to 0.1 $\mu\text{F}$
Output adjustment	Zero adjustment : Approximately $\pm 1$ V using the R-FINE. Both OUTPUT 1 and OUTPUT 2. Span adjustment : Continuous change from 1 to 1/10 using OUTPUT 2 ADJ independently.
Indicator of output	LED bar of 17 dots, monitor of OUTPUT 1 The green LED of the center lights within approximately $\pm 100$ mV. LEDs both ends blink above approximately $\pm 10.5$ V.
Numeric display	4 1/2 numeric LED, monitor of OUTPUT 2, adjustable output span using OUTPUT 2 ADJ Accuracy : $\pm 0.05$ % rdg within $\pm 1$ count Decimal point can be set in the FNC settings. Numeric display can change to 3 1/2 numeric LED.
Key lock function	The way of switching the key lock function to ON/OFF on the panel : Press and hold the [KEY LOCK] switch 1 second or more. Not applicable : [Input of calibration value] switch (+CAL, -CAL).



Item	Specifications
Remote function	Functions of the I/F connector on the rear panel : +CAL and -CAL, BAL function [ bridge check function (BRC), cable length compensation function (CLC), automatic range function (ARG), automatic balance (resistance balance)], RANGE OFF and KEY LOCK.
Storage of parameters	Parameters can be stored in flash memory (without backup battery).
Vibration resistance	Within 29.4 m/s <sup>2</sup> (50 Hz, each X Y Z for 10 minutes) and accordance with MIL-STD-810G 514.8
Voltage endurance	Between each input terminal and output terminal, chassis : AC1 kV for 1 minute Between AC power supply input and input, output, chassis : AC1.5 kV for 1 minute Between DC power supply input and input : AC1 kV or 1 minute Between DC power supply input and output, chassis : AC500 V or 1 minute
AC power supply	AC100 to 120 V +10 %, -15 %, AC200 to 240 V +10 %, -15 %, approx. 9 VA (AC100 V), approx. 11 VA (AC120 V), approx. 12 VA (AC240 V), 13 V <sub>Amax</sub> , 50 or 60 Hz (It can be selected using the [AC power supply <b>voltage selector</b> ] switch in the bottom of the amplifier.)
DC power supply	DC 10 to 30 V, within 6 VA
Range of operation temperature & humidity	Within -10 to +50 °C, 20 to 85 %RH, without condensation
Range of storage temperature & humidity	Within -20 to +70 °C, 10 to 90 %RH, without condensation
External dimensions	H 143±1 × W 49.5±0.5 × D 252±1 mm ※ Excluding protrusion
Mass	Approximate 1.4 kg
Compatible standards	Safety requirements : EN61010-1, EN61010-2-30 RoHS : EN IEC63000 EMC : EN61326-1, class A

p-p : Peak to Peak.

"μm/m" is described as "με" on the panel.

# 9. Reference

## 9.1. Characteristics of Frequency and Phase

Amplitude [dB] Example: Frequency characteristics of AS3603 and AS3803

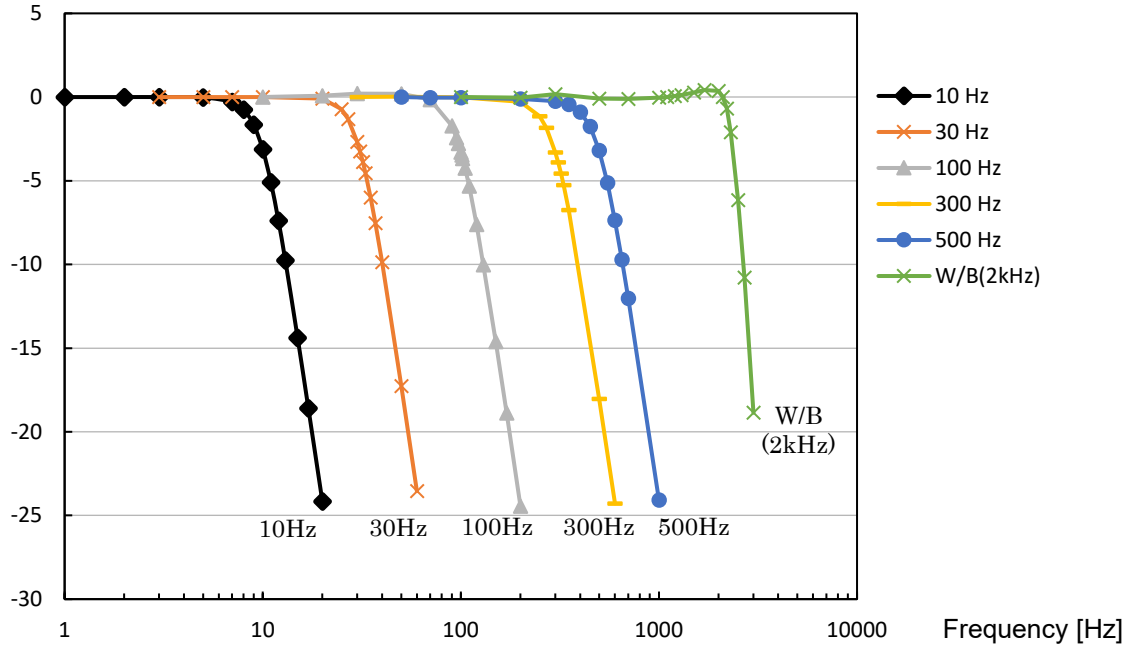

Phase delay [degree] Example: Phase characteristics of AS3603 and AS3803

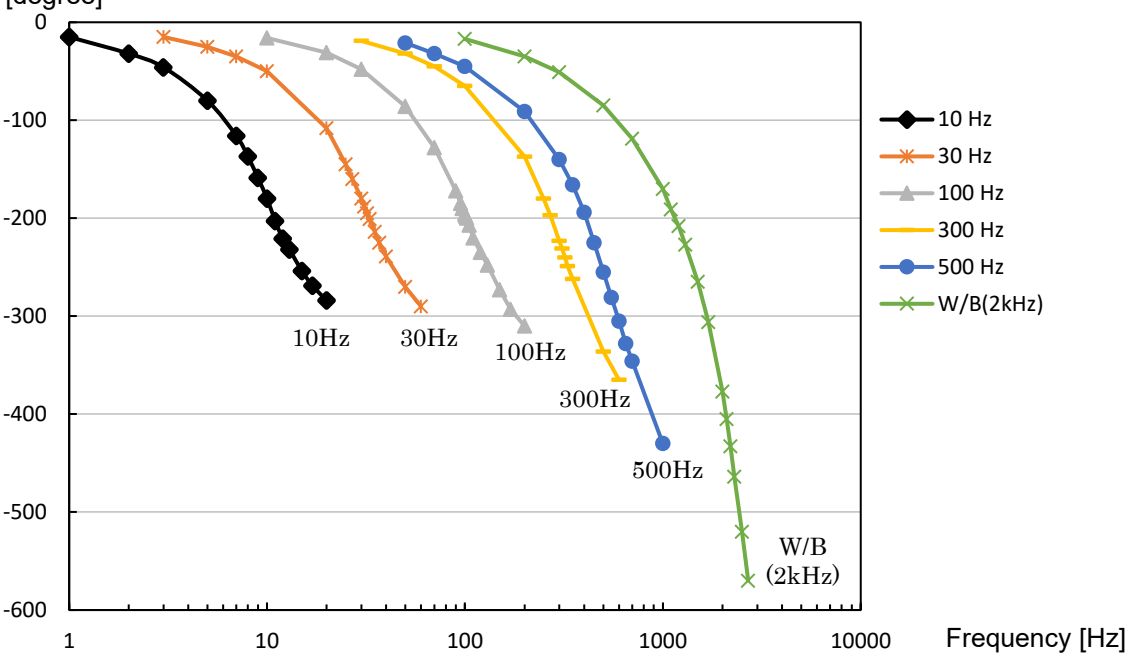

Amplitude [dB] Example: Frequency characteristics of AS3503 and AS3903

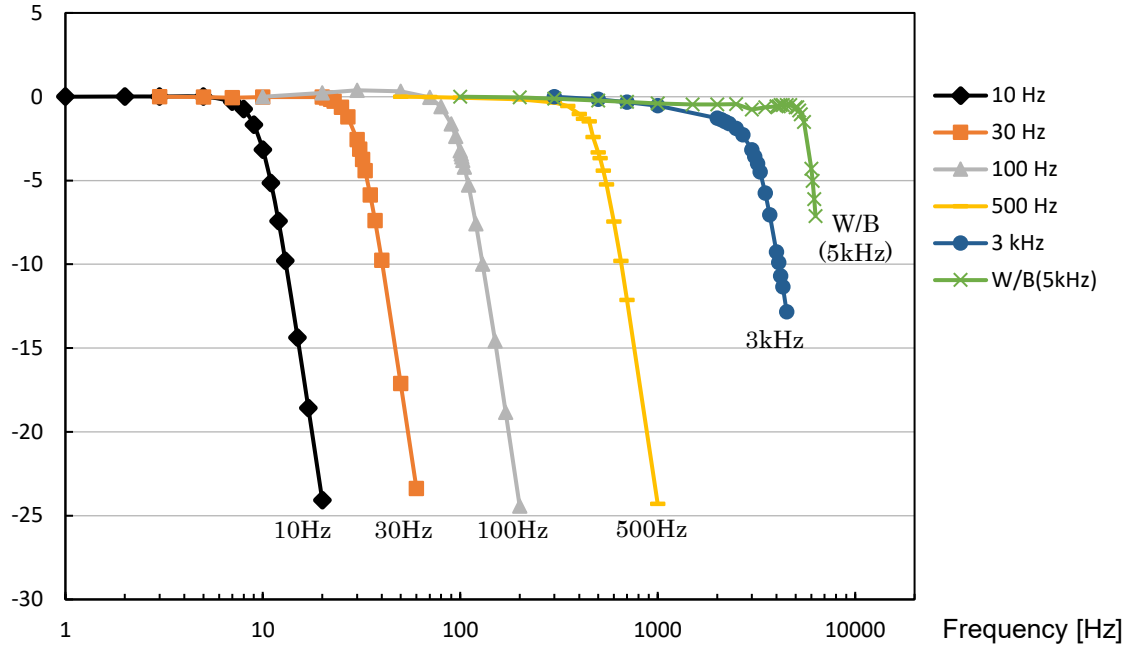

Phase delay [degree] Example: Phase characteristics of AS3503 and AS3903

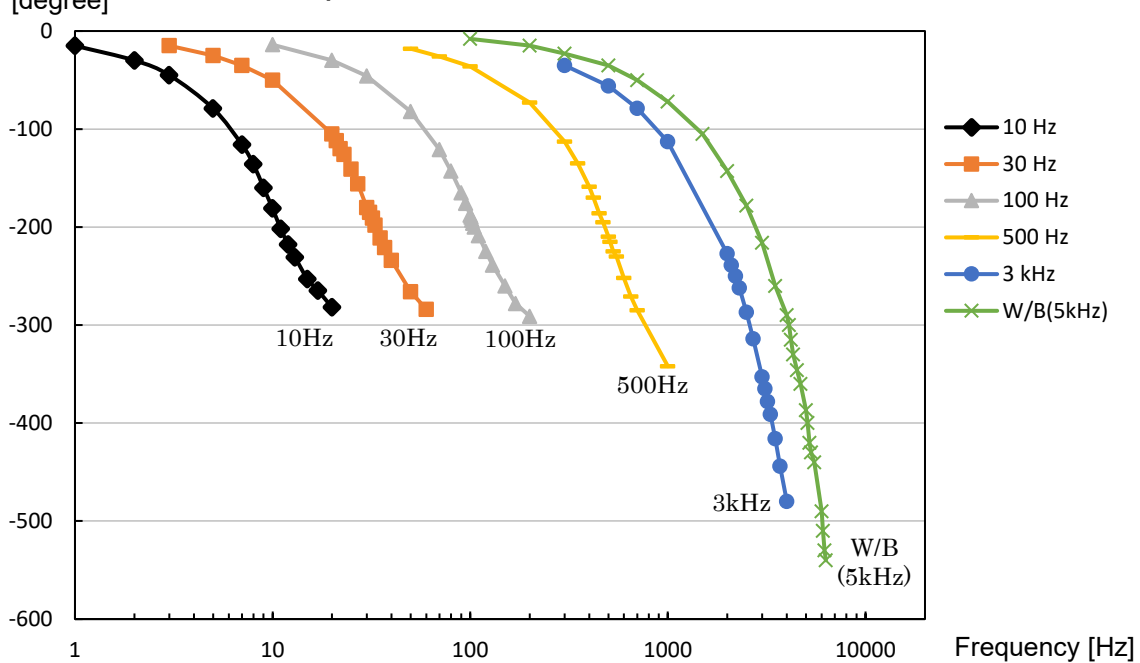

Amplitude [dB] Example: Frequency characteristics of AS3703

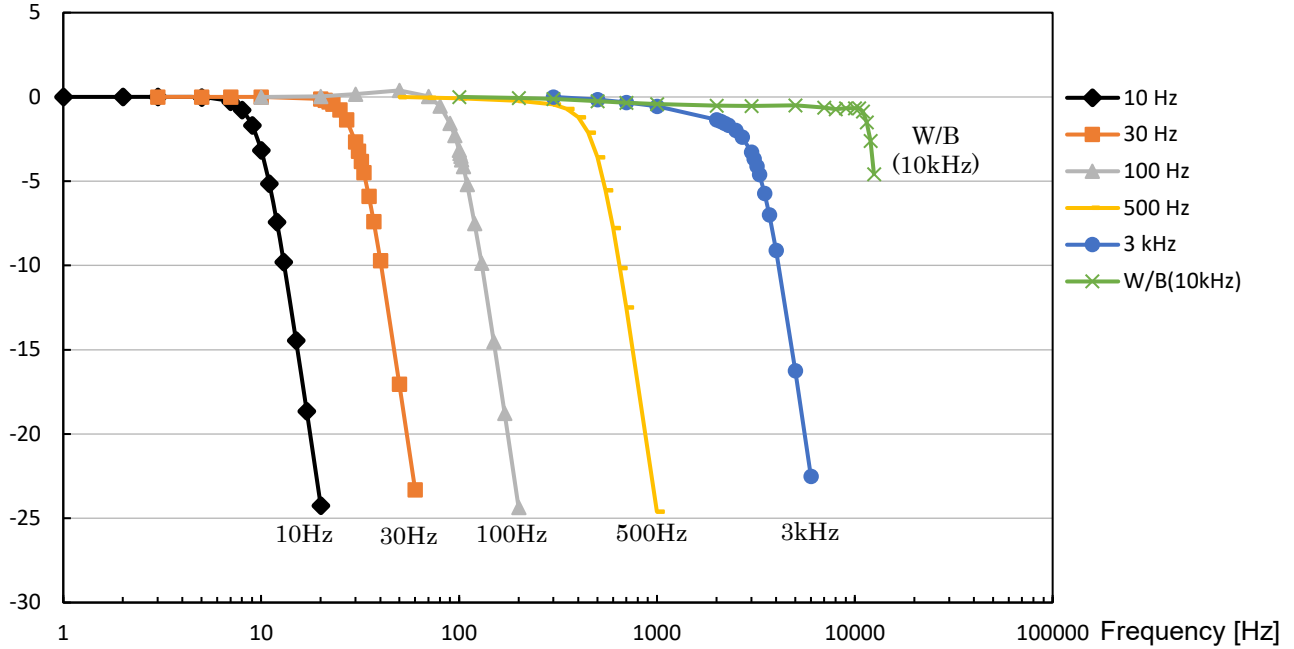

Phase delay [degree] Example: Phase characteristics of AS3703

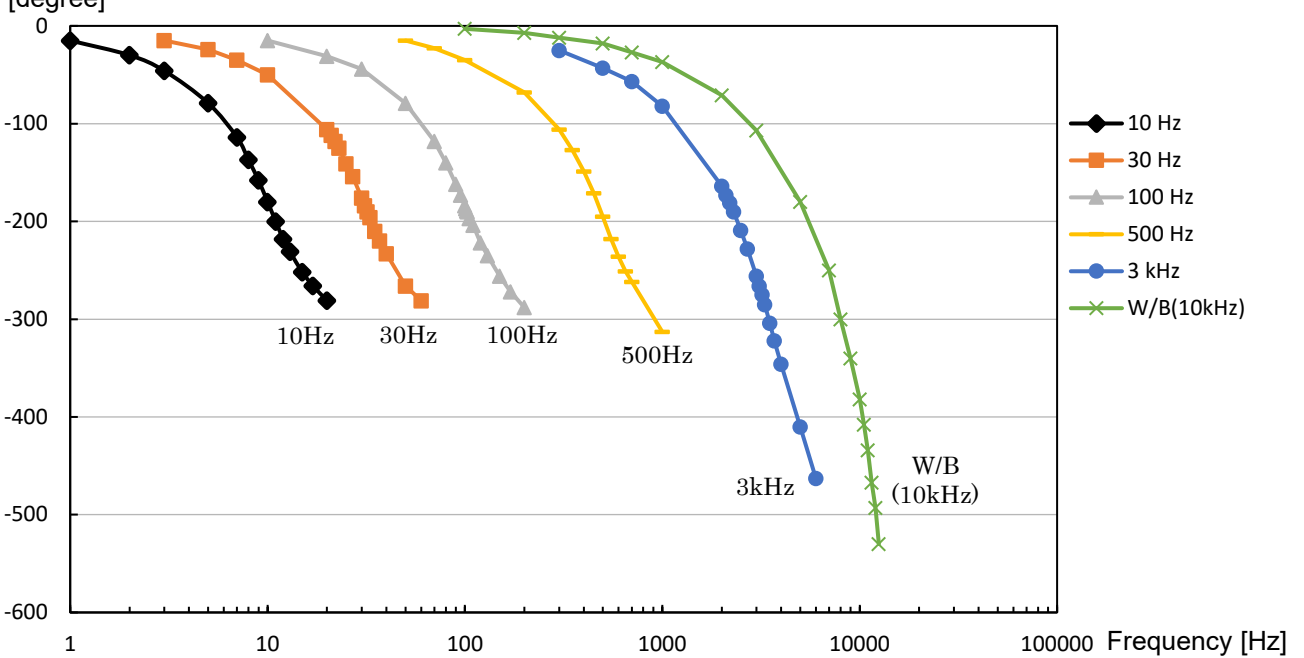

## 9.2. List of Option Cables

Table 25 List of option cables

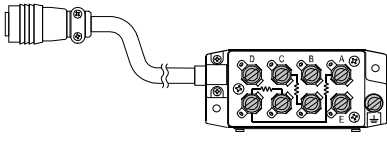
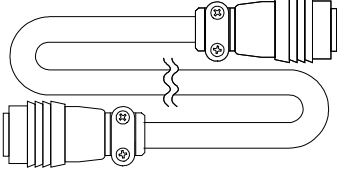
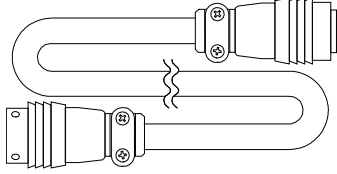
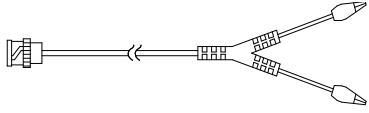
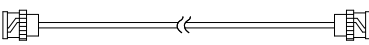
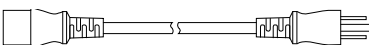
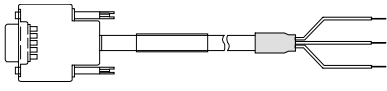
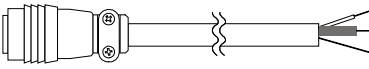
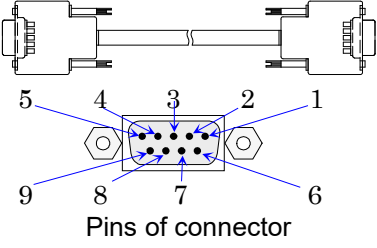
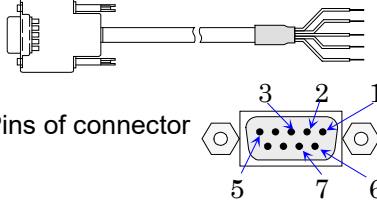
Name	View	Pin layout	Remarks
Bridge box Model 5370A (120 Ω) Model 5373A (350 Ω)		A ..... +BV B ..... -Input C ..... -BV D ..... +Input E ..... Shield	Length 3 m Outside diameter φ9.6 Core wire 0.5 mm <sup>2</sup> NDIS plug (male)
Relay cable Model AS30-501-005 (Low resistance type)		A ..... +BV B ..... -Input C ..... -BV D ..... +Input E ..... Shield	Length 5 m Outside diameter φ9.6 Core wire 0.5 mm <sup>2</sup> NDIS plug (male) x2
Extension cable Model AS30-502-005 (Low resistance type)		A ..... +BV B ..... -Input C ..... -BV D ..... +Input E ..... Shield	Length 5 m Outside diameter φ9.6 Core wire 0.5 mm <sup>2</sup> NDIS plug (male) NDIS jack (female)
Output cable Model AS30-503		Red ..... +Output (BNC wire) Black ..... Common	Length 2 m Metal BNC- Clips (+Red, -Black) Standard accessory 1
Output cable Model AS30-504		-	Length 2 m Metal BNC - Metal BNC
AC power supply cable Model AX-KO6165-200		-	Length 2 m For amplifier, storage case Standard accessory 1 (AC100 to 120 V)
DC power supply cable Model AS30-507		Red ..... DC+ Black ..... DC- Green ..... Shield	Length 2 m D-sub9pin male - open wire 8 pin DC+, 9 pin DC-
DC power supply cable For strage case Model AS30-508		Red ..... DC+ Black ..... DC- Green ..... Shield	Length 2.5 m Outside diameter φ10 max Core wire 1.25 mm <sup>2</sup>
Synchronization cable for strage case Model AS30-505		1 ..... +CAL 2 ..... -CAL 3 ..... BAL 4 ..... OSC 5 ..... AGND 6 ..... KEY LOCK 7 ..... GND 8 ..... N.C. 9 ..... N.C.	Length 1.8 m D-sub9pin male - D-sub9pin male Straight cable
Remote control cable Model AS30-506		1-red ..... +CAL 2-white ..... -CAL 3-green ..... BAL 6-yellow ..KEY LOCK 5, 7-black ..... GND	Length 2.5 m D-sub9pin male - open wire

## 9.3. Dimensions

### 9.3.1. Amplifier unit

AS3603  
AS3803

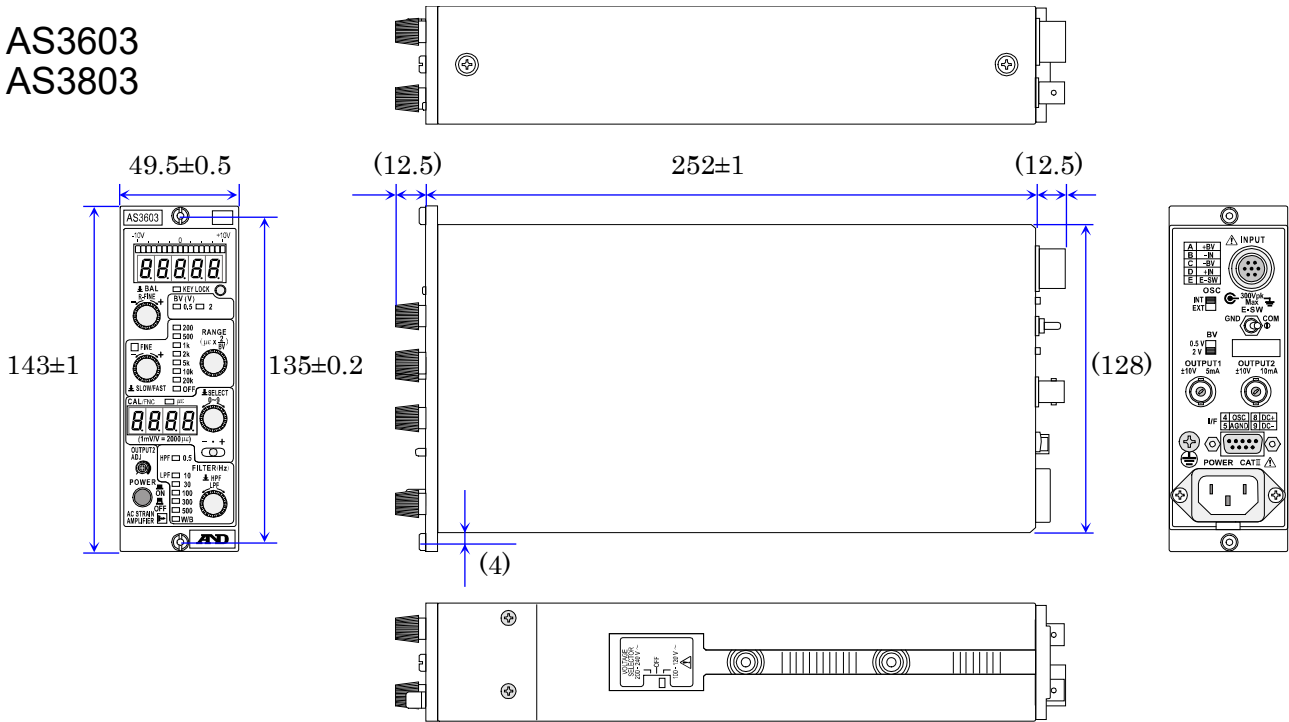

AS3503  
AS3703  
AS3903

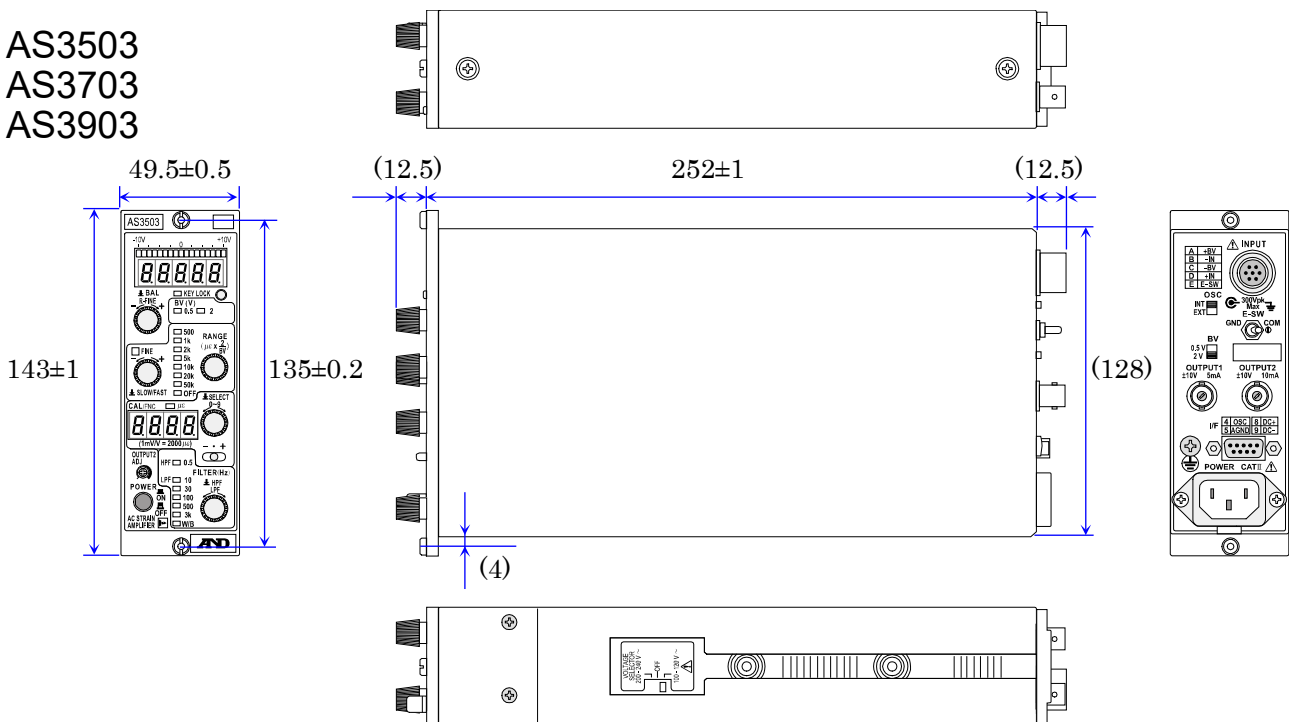

Drawing 37 Amplifier unit

## 9.3.2. Panel cutout dimensions

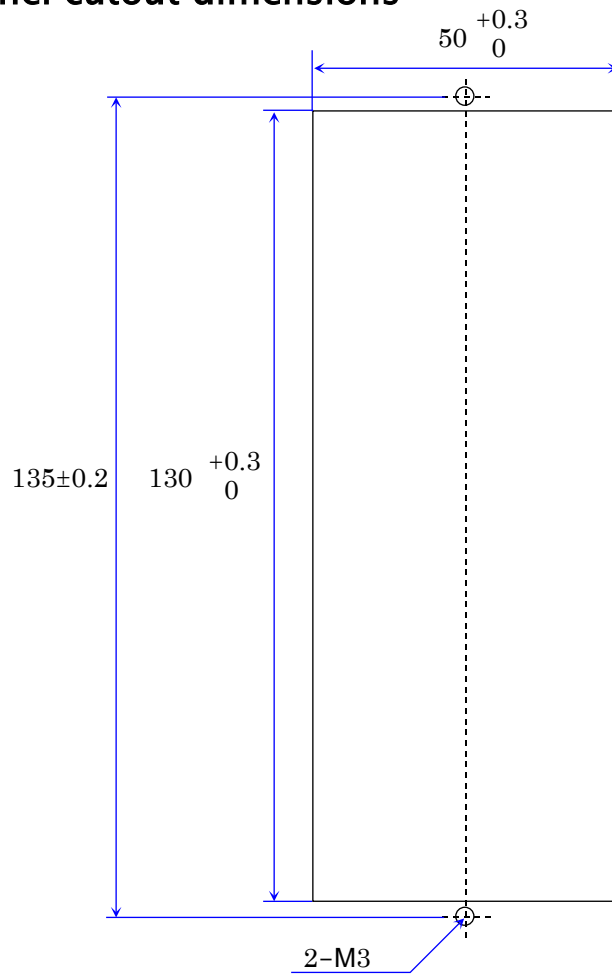

Drawing 38 Panel cutout dimensions

### 9.3.3. Bench top case

Model	Name	A	B
AS16-104	4CH bench top case	265	236
AS16-105	6CH bench top case	365	336
AS16-106	8CH bench top case	465	436

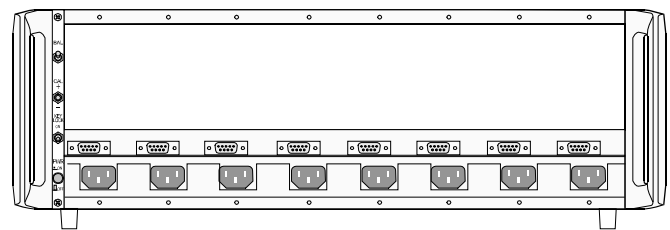
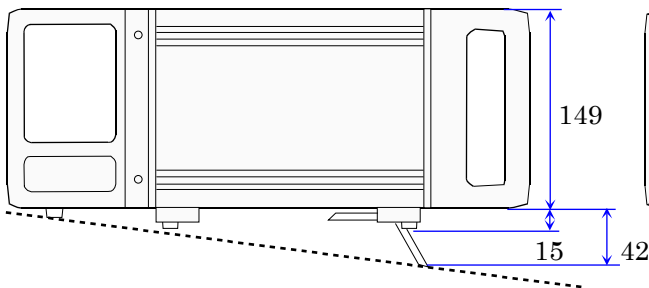
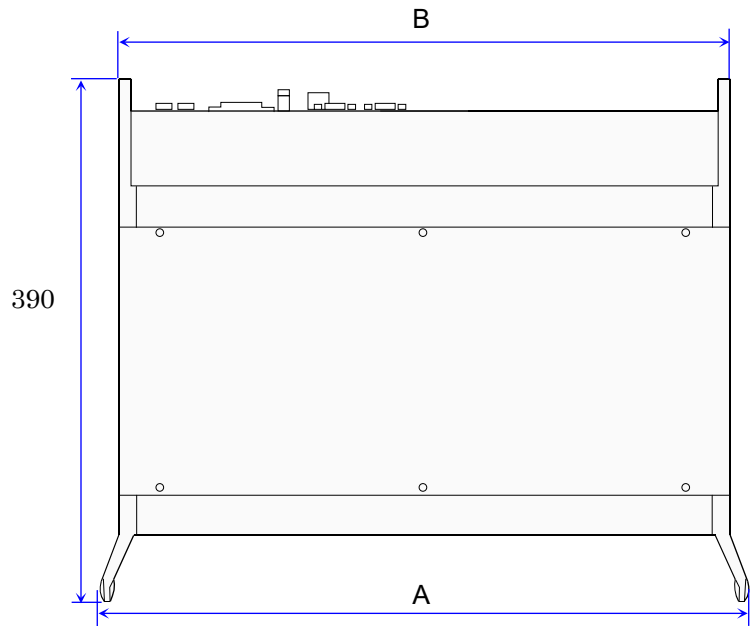
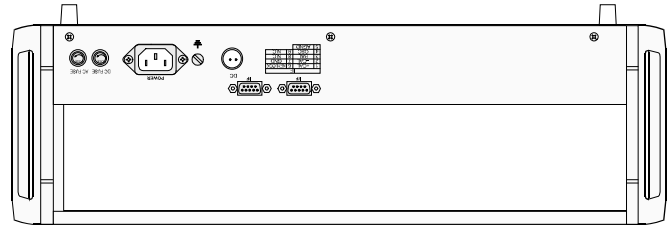

**Drawing 39 Bench top case**



### 9.3.4. Rack mount case

Model	Name
AS16-107	8CH rack mount case

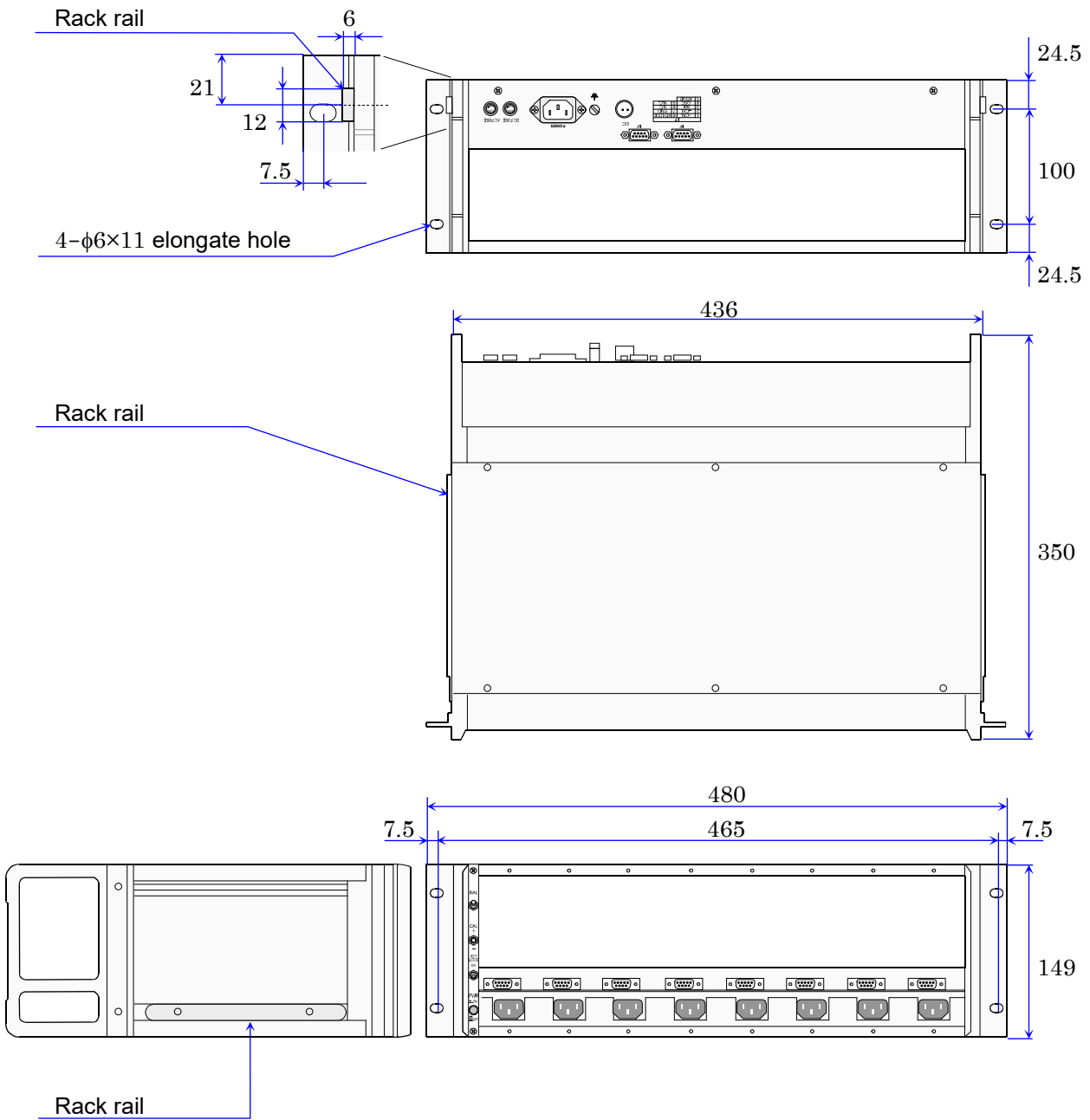

Drawing 40 Rack mount case

### 9.3.5. Fan unit

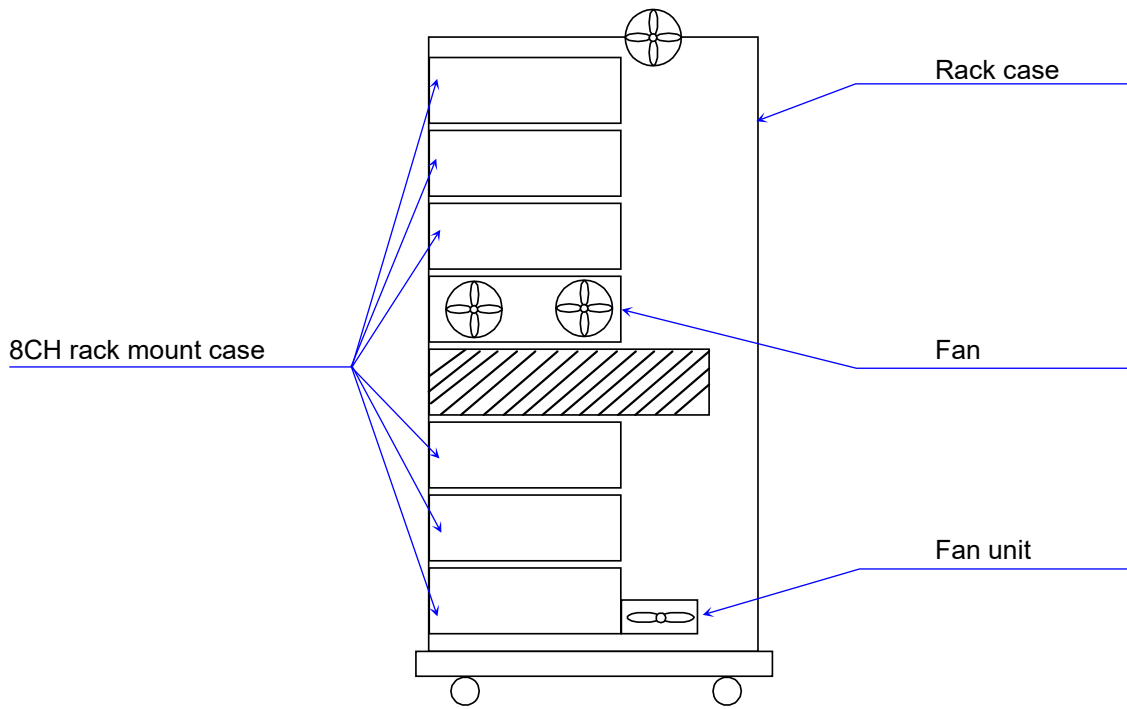
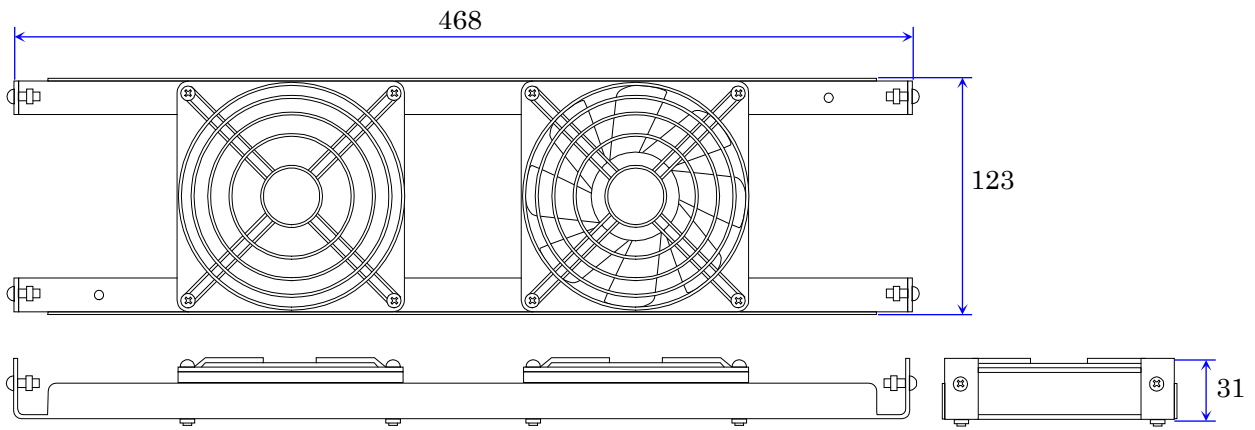

**Drawing 41 Fan unit**

9.3.6. Bridge box (5370A type, 5373A type)

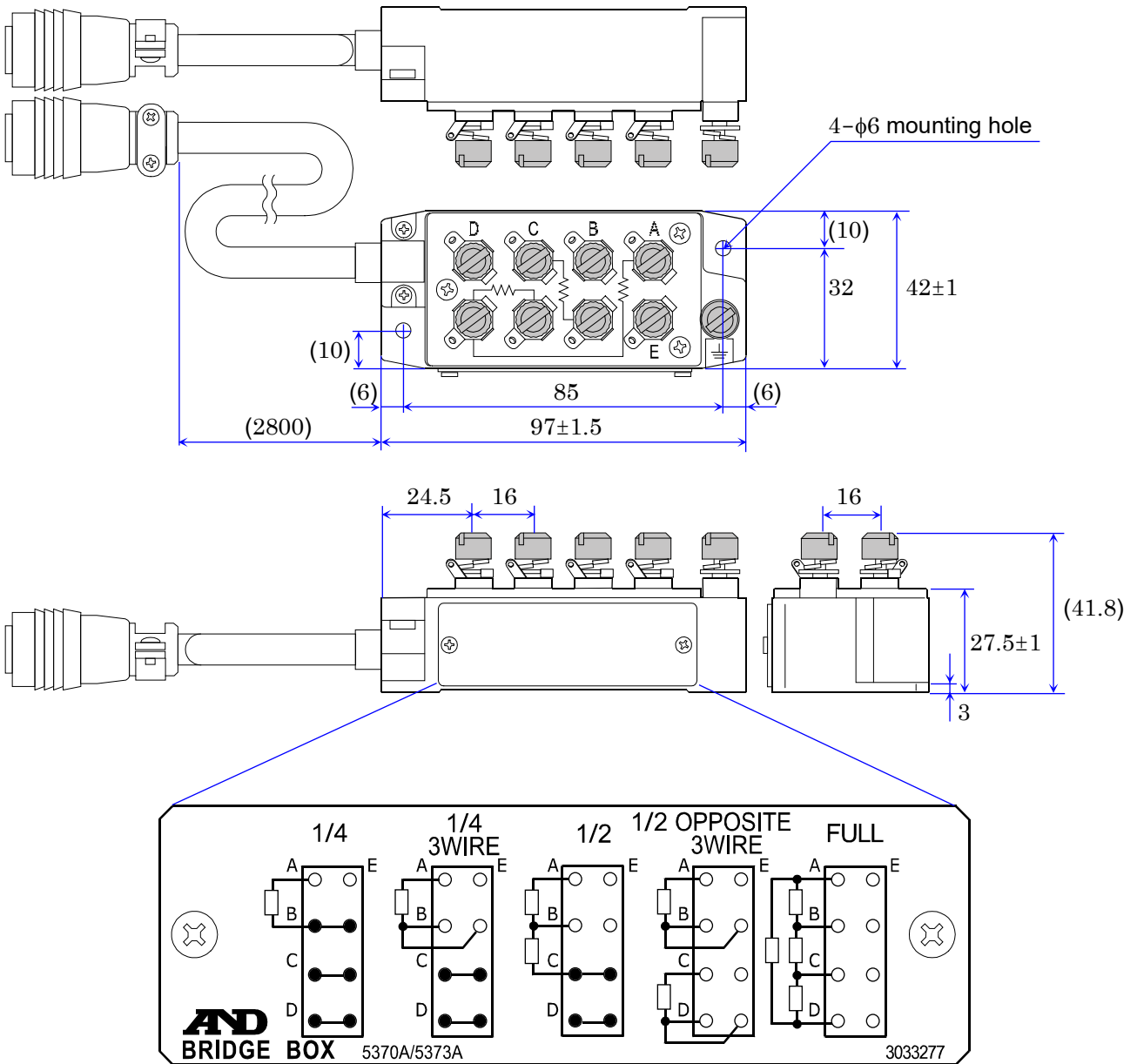

Drawing 42 Bridge box

---

## 10. For prolonged use

---

A&D Company, Limited

Thank you for purchasing an A&D Company, Limited. product.

For prolonged use that you have purchased the product, we recommend the following maintenance services.

### Warranty period

The warranty period for this product is one year from the date of purchase.

If malfunction to be ascribable to the our responsibility occurs, the product will be repaired free of charge.

### Maintenance service after warranty period

We accept the product repairment with charge after the warranty period.

Additionally, we accept overhaul of the product if you want.

---

## 11. Maintenance service

---

Our products use parts of electrolytic capacitor, variable resistance (volume), FAN, etc. that have lifetime.

Lifetime of parts depends on operating environment and frequency of use, are different, we recommend periodic maintenance service for longer time use and for more efficient use.

We recommend periodic checking and overhaul in perspective of repair and preventive maintenance so as to use the delivered product with safe and trust.

We guess that principal users send periodically the product to testing laboratory and calibrate it so as to maintain accuracy management. But, foreign matter and dust etc. invade into the product, it may cause malfunction and accident. Therefore, we recommend periodic checking and overhaul.

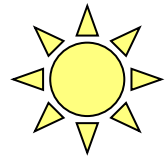

### Criterion of replacing parts that has life time

Condition of use: Use for 8 hours every day.

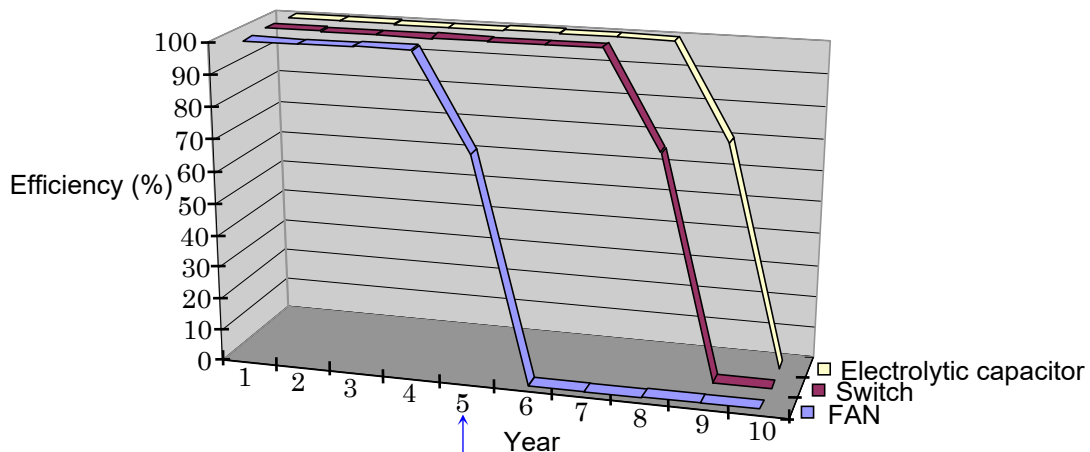

Start year that influence of aging occurs.  
\* We recommend overhaul.







CAN ICES-003(A)/NMB-003(A)



**KC Mark** Registration No. **R-R-AD7-AS3000**

Equipment Name: **AC strain amplifier**

Model: **AS3000 series** (AS3503,AS3603,AS3703,AS3803,AS3903)

Applicant & Manufacturer: A&D Company, Limited

Manufactured month and year:

Country of Manufacturing: Japan

### FCC - Supplier's Declaration of Conformity

47 CFR § 2.1077 Compliance Information

Model: AS3000 series(AS3503,AS3603,AS3703,AS3803,AS3903)

Responsible Party: A&D ENGINEERING, INC.

Address: 4622 Runway Boulevard Ann Arbor, MI 48108, U.S.A.

Tel: +1 800-726-3364

This device complies with part 15 of the FCC Rules. Operation is subject to the following two conditions: (1) This device may not cause harmful interference, and (2) this device must accept any interference received, including interference that may cause undesired operation.

NOTE: This equipment has been tested and found to comply with the limits for a Class A digital device, pursuant to part 15 of the FCC Rules. These limits are designed to provide reasonable protection against harmful interference when the equipment is operated in a commercial environment. This equipment generates, uses, and can radiate radio frequency energy and, if not installed and used in accordance with the instruction manual, may cause harmful interference to radio communications.

Operation of this equipment in a residential area is likely to cause harmful interference in which case the user will be required to correct the interference at his own expense.

The changes or modifications not expressly approved by the party responsible for compliance could void the user's authority to operate the equipment.

AS3000 series AC Strain Amplifier			
Instruction manual	1WMPD4004825	2024/01	1st Edition



### **A&D Company, Limited**

3-23-14 Higashi-Ikebukuro, Toshima-ku, Tokyo 170-0013, JAPAN  
Telephone: [81] (3) 5391-6132 Fax: [81] (3) 5391-1566

### **A&D ENGINEERING, INC.**

47747 Warm Springs Blvd, Fremont, California 94539, U.S.A.  
Tel: [1] (800) 726-3364 Weighing Support:[1] (888) 726-5931 Inspection Support:[1] (855) 332-8815

### **A&D INSTRUMENTS LIMITED**

Unit 24/26 Blacklands Way, Abingdon Business Park, Abingdon, Oxfordshire OX14 1DY United Kingdom  
Telephone: [44] (1235) 550420 Fax: [44] (1235) 550485

### **A&D AUSTRALASIA PTY LTD**

32 Dew Street, Thebarton, South Australia 5031, AUSTRALIA  
Telephone: [61] (8) 8301-8100 Fax: [61] (8) 8352-7409

### **A&D KOREA Limited**

한국에이.엔.디(주)  
서울특별시 영등포구 국제금융로6길33 (여의도동) 맨하탄빌딩 817 우편 번호 07331  
( 817, Manhattan Bldg., 33. Gukjegeumyung-ro 6-gil, Yeongdeungpo-gu, Seoul, 07331 Korea )  
전화: [82] (2) 780-4101 팩스: [82] (2) 782-4264

### **ООО A&D RUS**

### **ООО "ЭЙ энд ДИ РУС"**

Почтовый адрес:121357, Российская Федерация, г.Москва, ул. Верейская, дом 17  
Юридический адрес: 117545, Российская Федерация, г. Москва, ул. Дорожная, д.3, корп.6, комн. 86  
( 121357, Russian Federation, Moscow, Vereyskaya Street 17 )  
тел.: [7] (495) 937-33-44 факс: [7] (495) 937-55-66

### **A&D Instruments India Private Limited**

### **ऐ&डी इन्स्ट्रुमेन्ट्स इण्डिया प्रा० लिमिटेड**

D-48, उद्योग विहार , फेस -5, गुडगांव - 122016, हरियाणा , भारत  
( D-48, Udyog Vihar, Phase-V, Gurgaon - 122016, Haryana, India )  
फोन : [91] (124) 4715555 फैक्स : [91] (124) 4715599

### **A&D SCIENTECH TAIWAN LIMITED. A&D台灣分公司 艾安得股份有限公司**

台灣台北市中正區青島東路5號4樓  
( 4F No.5 Ching Tao East Road, Taipei Taiwan R.O.C. )  
Tel : [886](02) 2322-4722 Fax : [886](02) 2392-1794

### **A&D INSTRUMENTS (THAILAND) LIMITED**

บริษัท เอ แอนด์ ดี อินสตรูमेंท์ (ไทยแลนด์) จำกัด  
168/16 หมู่ที่ 1 ตำบลรังสิต อำเภอธัญบุรี จังหวัดปทุมธานี 12110 ประเทศไทย  
( 168/16 Moo 1, Rangsit, Thanyaburi, Pathumthani 12110 Thailand )  
Tel : [66] 20038911